

Please go to www.quoizel.com for product cleaning tips. Go to the **Care + Maintenance** selection.

Tools Required: Flathead screwdriver, Phillips screwdriver, pliers, wire cutters, wire strippers, electrical tape, safety glasses.

Light Source: (1) A19 Medium Base bulb 100W Maximum or
(1) Medium Base Vintage bulb is recommended but not supplied.

Estimated Assembly Time: 30-45 minutes

Preparation: Identify and inspect all parts before beginning installation. Check package content list and diagrams below to be sure all parts are present. If any parts are missing or damaged, do not attempt to assemble, install, or operate the fixture. Contact customer service for replacement parts.

⚠ Warnings and Cautions

Turn off electricity at circuit breaker or main fuse box before installation. Consult a licensed electrician if in doubt.

These instructions are provided for your safety. It is very important you read them completely before installing the fixture. We strongly recommend that a licensed, professional electrician perform the installation.

Disconnect fixture from power source before replacing bulbs. Make sure bulbs are given sufficient time to cool before removal.

Package Contents

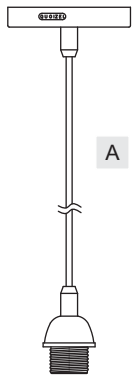

A Fixture Body
x 1

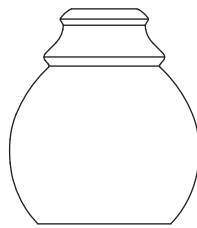

B Shade
x 1



C Socket Collar
x 1

STEP 2 – Attach Mounting Screws, Lock Washers and Hex Nuts to Crossbar

A. Line up a set of holes on the Crossbar (AA) and Holes on the Ceiling Canopy. Thread Mounting Screws (DD) into the holes on the Crossbar (AA). Pass Lock Washers (BB) and thread Hex Nuts (CC) onto the Mounting Screws (DD). Hand tighten until snug.

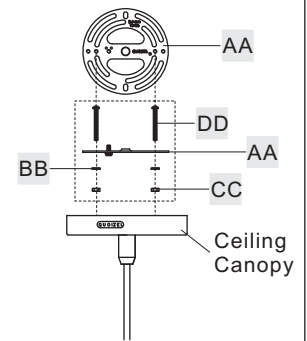
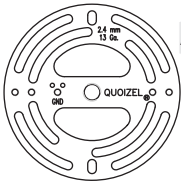
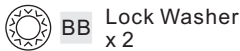

Figure 2

Hardware Contents



AA Crossbar
x 1



BB Lock Washer
x 2

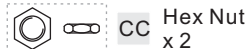

CC Hex Nut
x 2

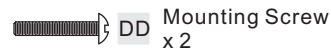

DD Mounting Screw
x 2

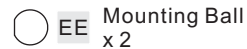

EE Mounting Ball
x 2

STEP 3 – Attach Crossbar to Outlet Box

A. Pass the supply wires through the Crossbar (AA). Attach the Crossbar (AA) to the Outlet Box with the head of the Green Ground Screw facing you. Secure it with Outlet Box Screws (not included). Tighten until snug.

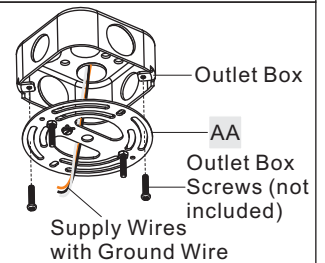

Figure 3

STEP 1 – Adjust Fixture Height

- Unlock Set Screw on the Coupling underside of Ceiling Canopy with screwdrivers. Push Wire in or pull wires out of Ceiling Canopy according to your desired hanging height. Once your desired hanging height is achieved, tighten Set Screws on the Coupling until snug.
- Move Wire Clasp on the top end of Wire until it is closed to hex nut in the center of the Ceiling Canopy.

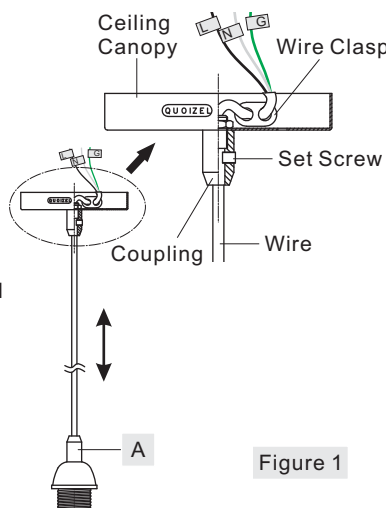

Figure 1

STEP 4 – Test Fitting Ceiling Canopy to Crossbar Assembly

A. Fit the Ceiling Canopy to Mounting Screws (DD) and secure with Mounting Balls (EE). Note: The Ceiling Canopy should be snug against the ceiling and the Mounting Balls (EE). If not, adjust the length of the Mounting Screws (DD) by unscrewing the Hex Nut (CC) and Lock Washer (BB) and then screwing Mounting Screws (DD) in or out of the Crossbar (AA) until the correct length is achieved. Once the Ceiling Canopy is secure, remove the Mounting Ball (EE) and Ceiling Canopy and proceed to Step 5.

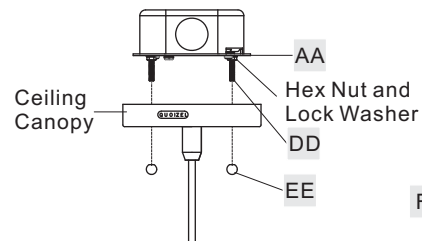

Figure 4

Thank you for purchasing a Quoizel product.
Need assistance with parts or assembly? Call Quoizel customer service at 1-800-645-3184
or visit us on-line at www.quoizel.com

STEP 5 – Make Wire Connections

A. Use standard wire connectors to make all wire connections. (Connectors are not included with fixture.) Strip and prepare wire ends according to instructions supplied with connectors. Wrap each connection with approved electrical tape and carefully stuff all the connected wires into the Outlet Box.

Note: If the electrical wire is going to be cut shorter than provided you will need to identify the "L" line wire, the "N" wire and the "G" wire before you cut the excess wire off. One is labeled N and the other labeled L. The third wire is labeled G. To do this strip back the clear wire covering the 3 fixture wires as far as you need to. This will expose each fixture wire individually. Separate the "L" wire from the other two and re-label the wire near where you want to make the cut. Be sure to mark the wire on the side of the fixture and not on the excess wire being cut and removed. Do the same labeling with the "N" wire and the "G" wire.

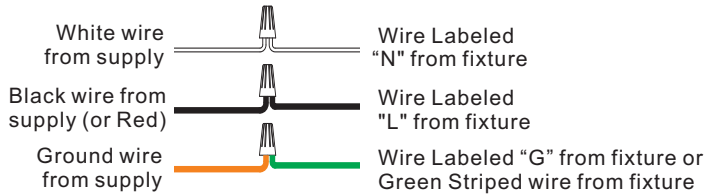

Figure 5

STEP 6 – Install Ceiling Canopy to Ceiling

A. Carefully tuck all wires into the outlet box and position the Ceiling Canopy over the outlet box. Align the holes in the ceiling canopy with the Mounting Screws (DD). Secure with Mounting Balls (EE) and hand tighten until snug.

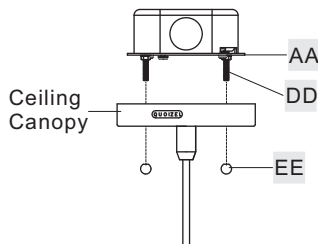

Figure 6

STEP 7 – Install Shade and Bulb

A. Place Shade (B) over socket and secure with Socket Collar (C). Hand tighten until snug.

B. Insert bulb into socket and screw snugly into place.

Your fixture is now assembled and ready to use. Enjoy!

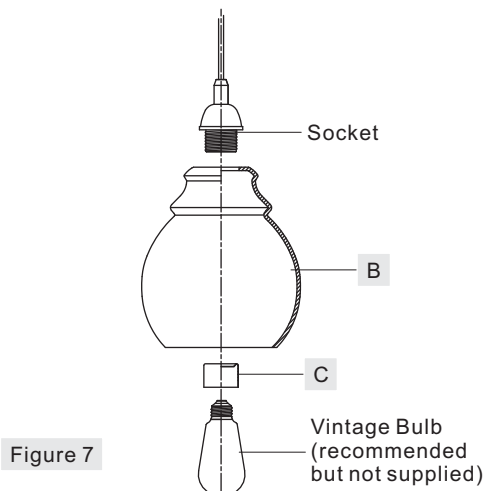
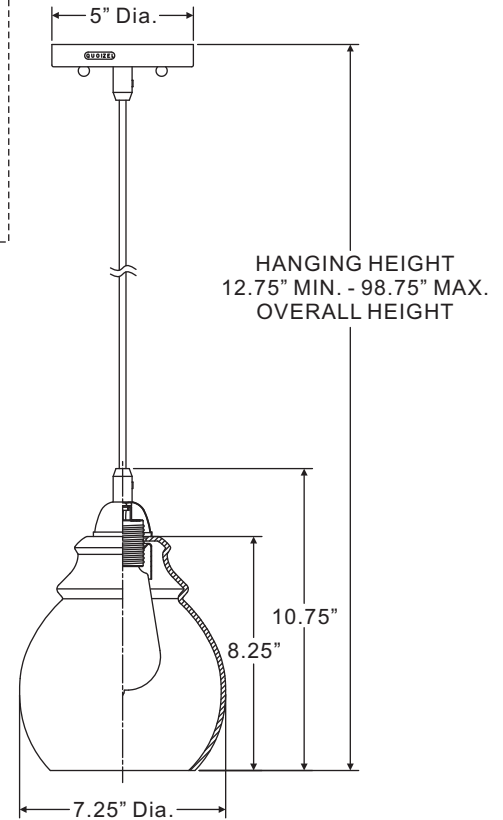
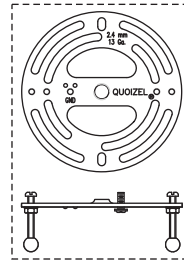

Figure 7

QPP2790K

FINISH: MYSTIC BLACK



NOTE: ALL DIMENSIONS ARE ROUNDED UP TO THE NEAREST 1/4"

Thank you for purchasing a Quoizel product.

Need assistance with parts or assembly? Call Quoizel customer service at 1-800-645-3184 or visit us on-line at www.quoise.com