

CAUSEUSE - CUIR RECONSTITUE NOIR

LOVE SEAT - BLACK BONDED LEATHER



I 8602BK

**INSTRUCTIONS D'ASSEMBLAGE
ASSEMBLY INSTRUCTIONS**



**POUR DE L'ASSISTANCE OU POUR COMMANDER
DES PIÈCES CONTACTEZ NOTRE DÉPARTEMENT
DE SERVICE À LA CLIENTÈLE.**

**FOR ASSISTANCE OR TO ORDER PARTS
CONTACT OUR CUSTOMER SERVICE DEPARTMENT**

WWW.MONARCHSERVICE.COM

IDENTIFICATION DES PIÈCES
PARTS IDENTIFICATION

1

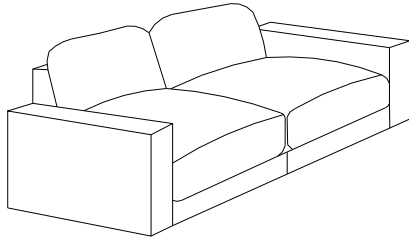

CAUSEUSE
LOVE SEAT

1MC
1PC

2

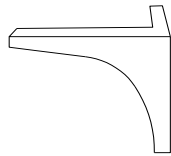

PATTE
LEG

4MCX
4PCS

IDENTIFICATION DES PIÈCES DE MONTAGE
HARDWARE IDENTIFICATION

A

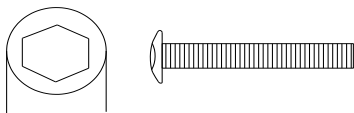

5/16" X 30MM

Ø 5/16" X 30MM

8MCX
8PCS

B



5/16" X 16MM

RONDELLE PLATTE
FLAT WASHER

8MCX
8PCS

C

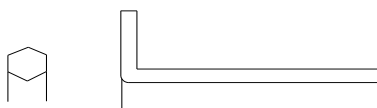

5 X 70MM

CLÉ HEXAGONALE
ALLEN KEY

1MC
1PC

ÉTAPE / STEP 1

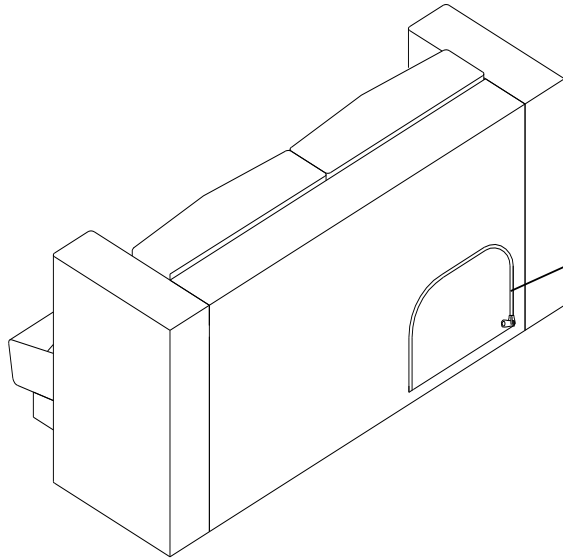

La quincaillerie et les pattes sont entreposés dans le compartiment en-dessous de l'unité

Hardware and legs are located in the compartment under the unit.

2

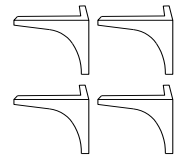

ÉTAPE / STEP 2

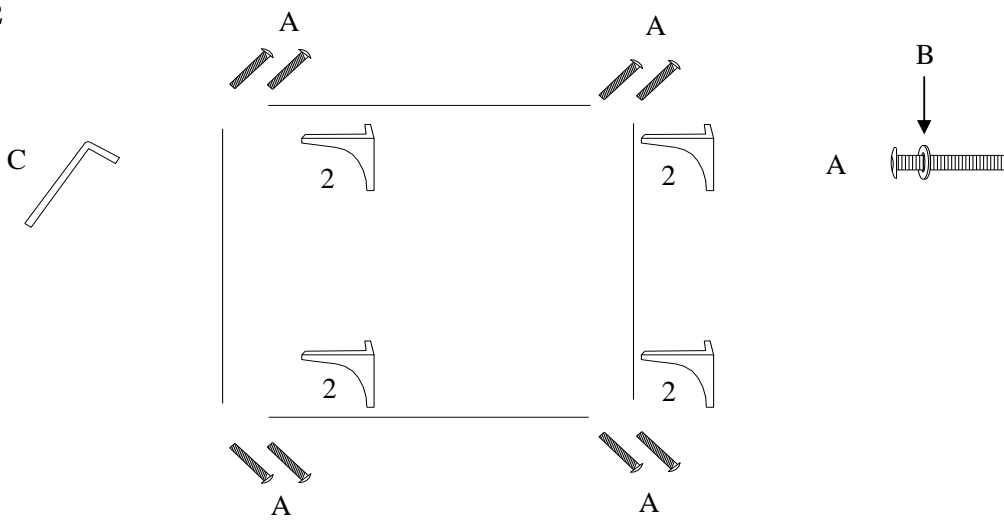

ÉTAPE / STEP 3

