

# Installation Instructions / Warranty

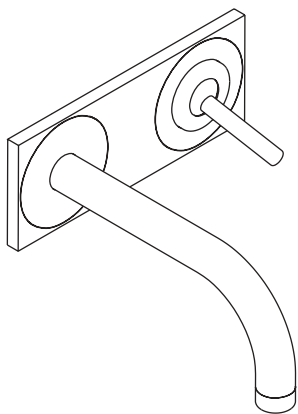

**Uno**  
38117XX1  
(see page 2)

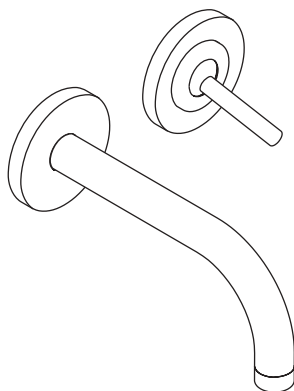

**Uno**  
38118XX1  
(see page 8)

# Uno Wall-mount lavatory trim kit with plate 38117XX1

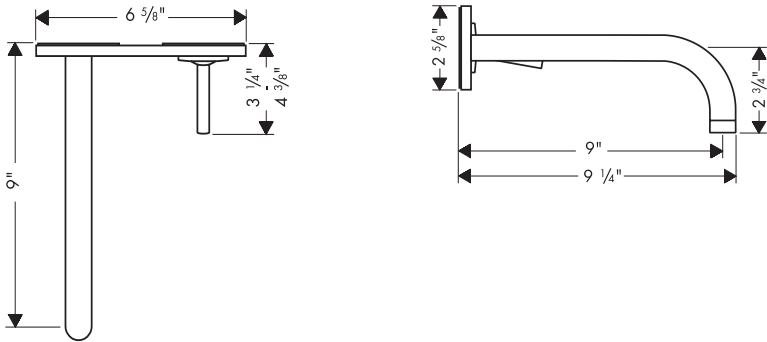

## Technical Data

Flow Rate	max. 2.2 gpm
Recommended pressure	14.5 - 75 psi
Recommended hot water temp.	120° - 140°F*
Hot and cold inlet ports	1/2" NPT (female)

\*Many municipalities have codes limiting the maximum hot water temperature to 120°F or below. Please know and follow all applicable local codes when setting the temperature on the water heater.

## Special Tools Recommended for Installation (not included)

- 17 mm deep socket wrench
- 27 mm deep socket wrench

## Installation Considerations

**Save time and frustration: plan the installation of both the faucet and the lavatory carefully.**

Rough-in 38111181 must be installed, and the finished wall complete prior to installation of this trim kit.

For best results, Hansgrohe recommends that this unit be installed by a licensed, professional plumber.

**A drain is not included with this trim kit.** The manufacturer of the lavatory can provide recommendations as to suitable drains.

## Installation Instructions

TURN OFF THE WATER AT THE SUPPLY BEFORE BEGINNING THE INSTALLATION.

- Remove the caps from the plaster shields. Cut the plaster shields 1/16" from the surface of the finished wall. Seal around the plaster shields with a suitable, non-staining, water-proof bathroom sealant.

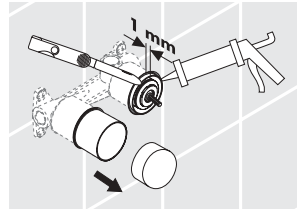

- Use a 27 mm deep socket wrench to remove the old cartridge assembly, cup washers, and springs. Discard the old cup washers and springs.
- Use a 17 mm deep socket wrench to remove the plug from the spout port.

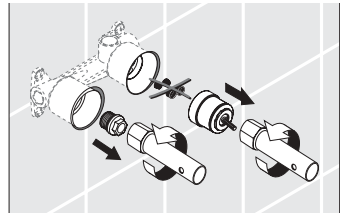

- Remove the cartridge housing and the rear guard from the old cartridge assembly. Install the cartridge housing and rear guard on the new cartridge, included with the trim kit. Discard the old cartridge.

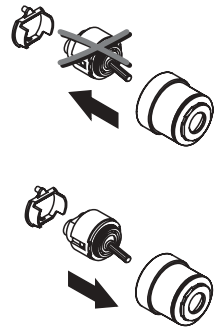

- Install the new springs and cup washers in the valve body. Install the cartridge assembly.

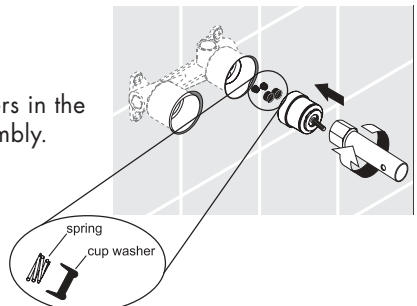

- Install the handle. Tighten the set screw using the enclosed 2 mm allen wrench.

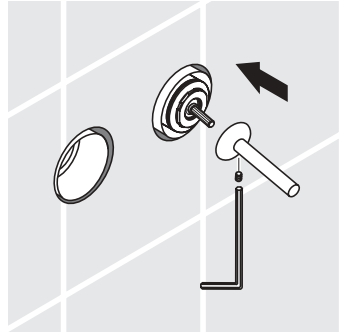

- Measure the distance from the surface of the finished wall to the end of the handle.

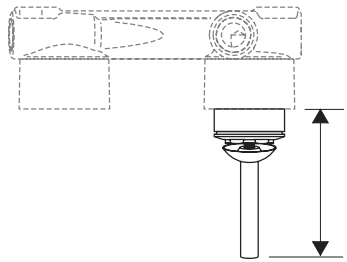

If the distance is  $3 \frac{1}{4}'' - 3 \frac{7}{8}''$ , select the two "A" sleeves ( $1\text{-}1\frac{1}{4}''$  long).



If the distance is  $3 \frac{7}{8}'' - 4 \frac{3}{8}''$ , select the two "B" sleeves ( $7\text{-}8''$  long).



If the distance is  $4 \frac{3}{8}''$ , select the two "C" sleeves ( $1\text{-}2''$  long).

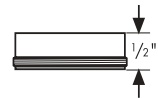

- Screw the escutcheon retainers to the ends of the two sleeves.

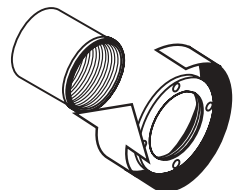

- Measure the distance from the outside surface of the finished wall to the spout port ("X"). Add 5/8" to X.

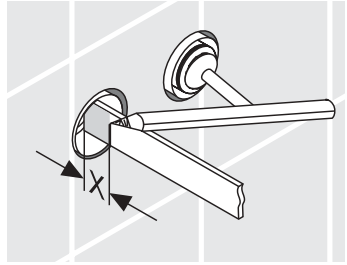

- Measure the threaded end of the spout. Using proper tools and safety practices, cut the spout so that the threaded portion is  $X + 5/8$ " long.

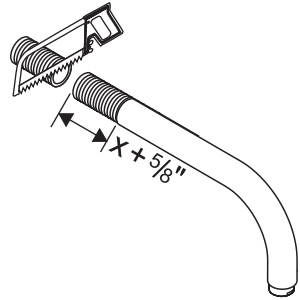

- Place the plate against the wall. Screw the sleeve/escutcheon retainer assemblies through the plate and into the rough.

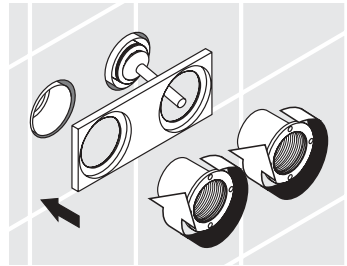

- Use the service key to tighten the escutcheon retainers against the plate.

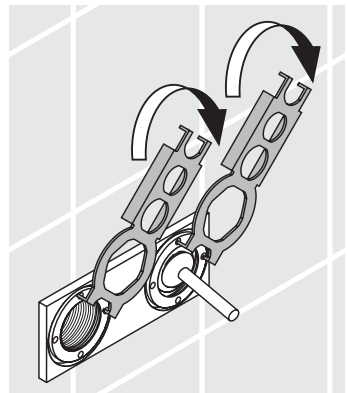

- Lightly coat the threads on the escutcheons with the included lubricant. Screw the escutcheons onto the retainers.

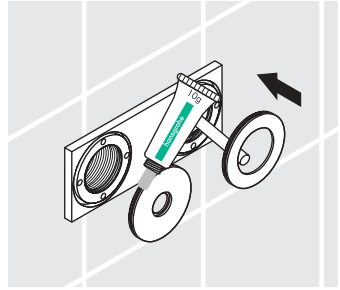

- Wrap the threads on the spout with several layers of a good quality Teflon™ tape. Screw the spout into the rough.
- Push the cap over the handle assembly.

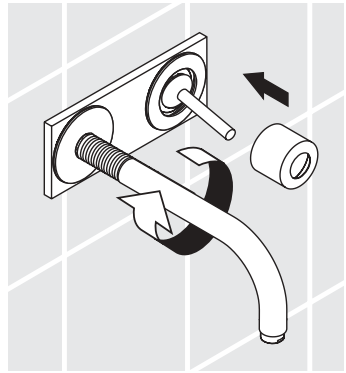

## User Instructions

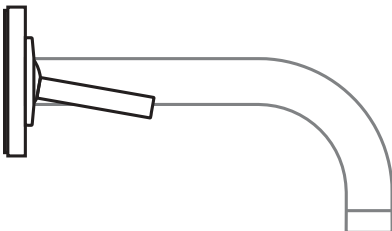

Pivot the handle up to turn the faucet on, down to turn it off.

Pivot the handle to the left for warmer water, to the right for cooler water.

# Replacement Parts

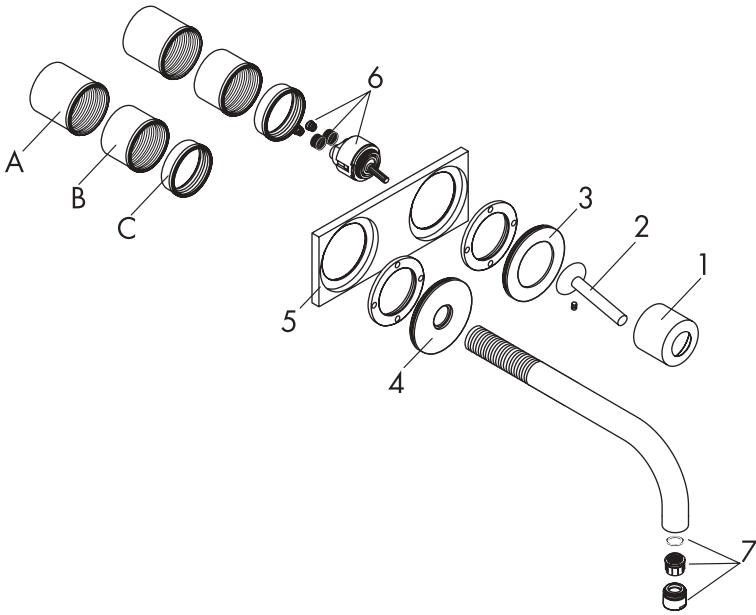

1	Cap	96908XXX
2	Handle	10092XXX
3	Handle Escutcheon	96912XXX
4	Spout Escutcheon	96913XXX
5	Plate	96914XXX
6	Cartridge	96339000
7	Aerator	96911XXX

XXX = Color Code  
 001 Chrome  
 811 Satinox

# Uno Wall-mount lavatory trim kit 38118XX1

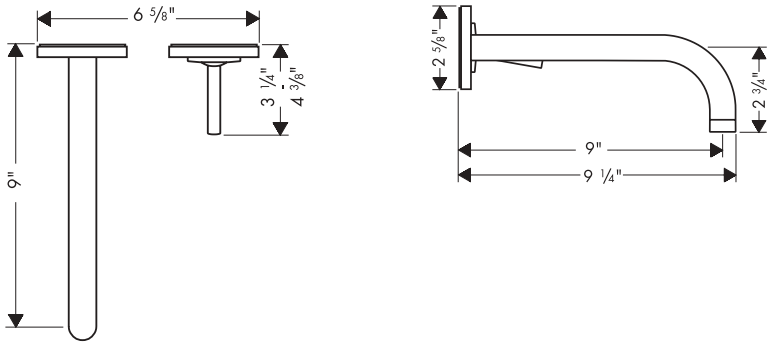

## Technical Data

Flow Rate	max. 2.2 gpm
Recommended pressure	14.5 - 75 psi
Recommended hot water temp.	120° - 140°F*
Hot and cold inlet ports	1/2" NPT (female)

\*Many municipalities have codes limiting the maximum hot water temperature to 120°F or below. Please know and follow all applicable local codes when setting the temperature on the water heater.

## Special Tools Recommended for Installation (not included)

17 mm deep socket wrench  
27 mm deep socket wrench

## Installation Considerations

**Save time and frustration: plan the installation of both the faucet and the lavatory carefully.**

Rough-in 38111181 must be installed, and the finished wall complete prior to installation of this trim kit.

For best results, Hansgrohe recommends that this unit be installed by a licensed, professional plumber.

**A drain is not included with this trim kit.** The manufacturer of the lavatory can provide recommendations as to suitable drains.



# Installation Instructions

TURN OFF THE WATER AT THE SUPPLY BEFORE BEGINNING THE INSTALLATION.

- Remove the caps from the plaster shields. Cut the plaster shields 1/16" from the surface of the finished wall. Seal around the plaster shields with a suitable, non-staining, water-proof bathroom sealant.

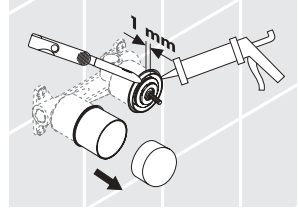

- Use a 27 mm deep socket wrench to remove the old cartridge assembly, cup washers, and springs. Discard the old cup washers and springs.
- Use a 17 mm deep socket wrench to remove the plug from the spout port.

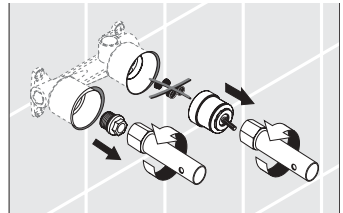

- Remove the cartridge housing and the rear guard from the old cartridge assembly. Install the cartridge housing and rear guard on the new cartridge, included with the trim kit. Discard the old cartridge.

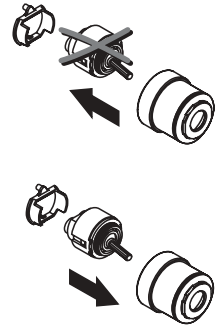

- Install the new springs and cup washers in the valve body. Install the cartridge assembly.

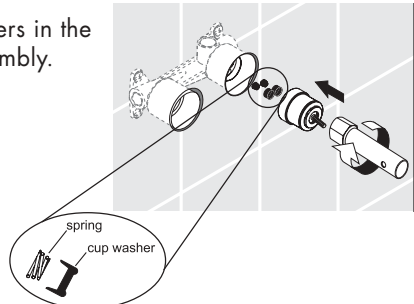

- Install the handle. Tighten the set screw using the enclosed 2 mm allen wrench.

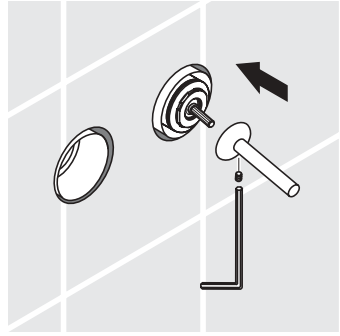

- Measure the distance from the surface of the finished wall to the end of the handle.

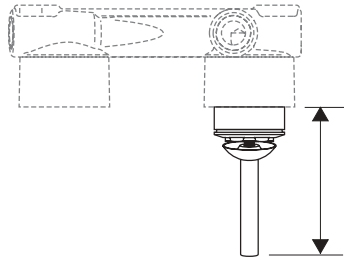

If the distance is  $3 \frac{1}{4}'' - 3 \frac{7}{8}''$ , select the "A" sleeve ( $1\text{-}1\frac{1}{4}''$  long).



If the distance is  $3 \frac{7}{8}'' - 4 \frac{3}{8}''$ , select the "B" sleeve ( $7\text{/}8''$  long)



If the distance is  $4 \frac{3}{8}''$ , select the "C" sleeve ( $1\text{/}2''$  long)

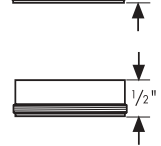

- Place a gasket in the handle escutcheon. Screw the handle escutcheon to the end of the sleeve.

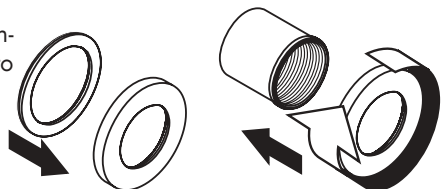

- Install the handle escutcheon / sleeve to the valve.

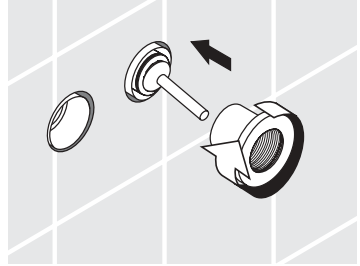

- Install the handle cap.

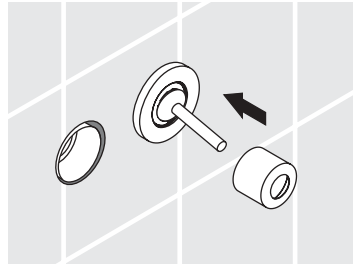

- Measure the distance from the outside surface of the finished wall to the spout port ("X"). Add 5/8" to X.

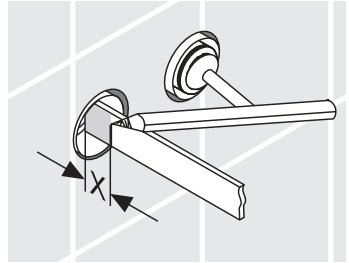

- Measure the threaded end of the spout. Using proper tools and safety practices, cut the spout so that the threaded portion is  $X + 5/8$ " long.

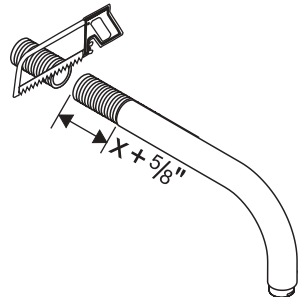

- Install the spout escutcheon and gasket to the spout.

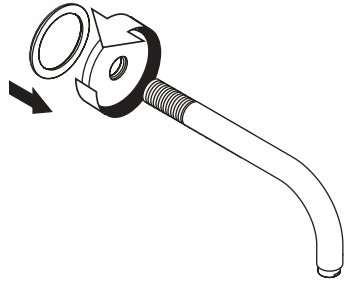

- Wrap the threads with several layers of good quality Teflon™ tape. Install the spout.

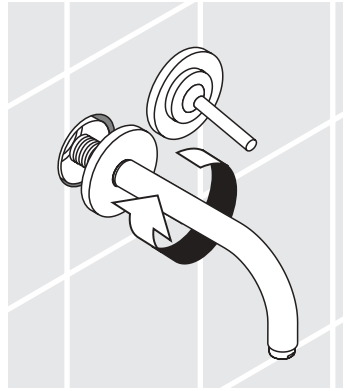

## User Instructions

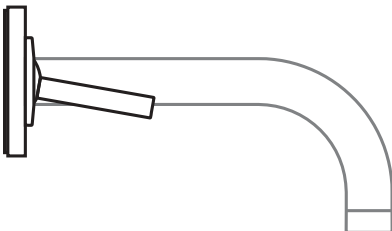

Pivot the handle up to turn the faucet on, down to turn it off.

Pivot the handle to the left for warmer water, to the right for cooler water.

# Replacement Parts

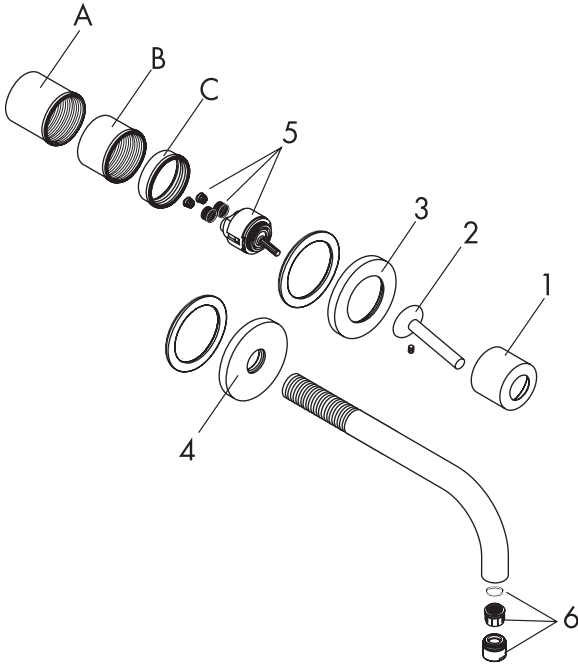

1	Cap	96908XXX
2	Handle	10092XXX
3	Handle Escutcheon	96909XXX
4	Spout Escutcheon	96910XXX
5	Cartridge	96339000
6	Aerator	96911XXX

XXX = Color Code  
001 Chrome  
811 Satinox

## **Cleaning Recommendation for Hansgrohe Products**

Modern faucetry and shower products utilize a combination of materials to comply with the needs of the market with regard to design and functionality.

To avoid damage, it is necessary to use some caution when cleaning. Damage caused by improper treatment is not covered under the Hansgrohe warranty.

### **Cleaning Materials for Faucets and Showers**

- To remove lime scale, use only products made specifically for that purpose. Always follow the manufacturer's instructions when using.
- Do not use cleaners that contain hydrochloric, formic, acetic, or phosphoric acids, as these will cause considerable damage to finishes and to plastic components.
- Never mix cleaning materials.
- Never use cleaners containing abrasives. Do not use abrasive cleaning cloths, pads, or sponges.

### **Cleaning Procedures**

- Clean your faucets and shower products as and when required. Regular cleaning will prevent scale buildup and water spotting.
- Follow the label instructions. Do not allow any cleaner to remain on the product for longer than necessary.
- When using spray cleaners, spray first onto a sponge or cloth – do not spray directly onto the product.
- After cleaning, rinse thoroughly with clear water to remove any cleaner residue.

### **Important**

- Soap and shampoo residue can also cause damage to the product. Rinse well with clean water after use.
- If the surface is already damaged, harsh cleaning materials will cause further damage.

## **Limited Lifetime Consumer Warranty**

This product has been manufactured and tested to the highest quality standards by Hansgrohe, Inc. ("Hansgrohe"). This warranty is limited to Hansgrohe products which are purchased by a consumer in the United States after March 1, 1996, and installed in either the United States or Canada.

### **WHO IS COVERED BY THE WARRANTY**

This warranty extends to the original consumer purchaser only.

### **WHAT IS COVERED BY THE WARRANTY**

This warranty covers only your Hansgrohe manufactured product. Hansgrohe warrants this product against defects in material or workmanship as follows: Hansgrohe will repair at no charge for parts only or, at its option, replace any product or part of the product which proves defective because of improper workmanship and/or material, under normal installation, use, service and maintenance. If Hansgrohe is unable to provide a replacement and repair is not practical or cannot be timely made, Hansgrohe may elect to refund the purchase price in exchange for the return of the product.

### **LENGTH OF WARRANTY**

Replacement or repaired parts of products will be covered for the term of this warranty as stated in the following two sentences. If you are a consumer who purchased the product for use primarily for personal, family, or household purposes, this warranty extends for as long as you own the product and the home in which the product is installed. If you purchased the product for use primarily for any other purpose, including, without limitation, a commercial purpose, this warranty extends only (i) for 1 year, with respect to Interaktiv and Retroaktiv products, and (ii) for 5 years, with respect to AXOR, ShowerPower and Pharo products.

**THIS WARRANTY DOES NOT COVER, AND HANSGROHE WILL NOT PAY FOR:**

- A. Conditions, malfunctions or damage not resulting from defects in material or workmanship.
- B. Conditions, malfunctions or damage resulting from (1) improper installation, improper maintenance, misuse, abuse, negligence, accident or alteration, or (2) the use of abrasive or caustic cleaning agents or "no rinse" cleaning products, or the use of the product in any manner contrary to the product instructions.
- C. Labor or other expenses for the disconnection or return of the product for warranty service, or for installation or reinstallation of the product.
- D. Accessories or related products not manufactured by Hansgrohe.

**TO OBTAIN WARRANTY SERVICE**

Contact your Hansgrohe retailer, or write to Technical Service at:

Hansgrohe Inc.  
1492 Bluegrass Lakes Parkway  
Alpharetta GA 30004

Or, call Hansgrohe toll-free at (800) 334-0455.

In requesting warranty service, you will need to provide

- 1. The sales receipt or other evidence of the date and place of purchase.
- 2. A description of the problem.
- 3. Delivery of the product or the defective part, postage prepaid and carefully packed and insured, to Hansgrohe Inc. 1492 Bluegrass Lakes Parkway, Alpharetta, Georgia 30004, Attention: Technical Service, if required by Hansgrohe.

When warranty service is completed, any repaired or replacement product or part will be returned to you postage prepaid.

**EXCLUSIONS AND LIMITATIONS**

**REPAIR OR REPLACEMENT (OR, IN LIMITED CIRCUMSTANCES, REFUND OF THE PURCHASE PRICE) AS PROVIDED UNDER THIS WARRANTY IS THE EXCLUSIVE REMEDY OF THE PURCHASER. HANSGROHE NEITHER ASSUMES NOR AUTHORIZES ANY PERSON TO CREATE FOR IT ANY OBLIGATION OR LIABILITY IN CONNECTION WITH THIS PRODUCT.**

**HANSGROHE SHALL NOT BE LIABLE TO PURCHASER OR ANY PERSON FOR ANY INCIDENTAL, SPECIAL, OR CONSEQUENTIAL DAMAGES, ARISING OUT OF BREACH OF THIS WARRANTY OR ANY IMPLIED WARRANTY (INCLUDING MERCHANTABILITY).**

Some States do not allow the exclusion or limitation of incidental or consequential damages, so the above limitation or exclusion may not apply to you.

This warranty gives you specific legal rights, and you may have other rights which vary from State to State.

You may be required by law to give us a reasonable opportunity to correct or cure any failure to comply before you can bring any action in court against us under the Magnuson-Moss Warranty Act.

**PRODUCT INSTRUCTIONS AND QUESTIONS**

Upon purchase or prior to installation, please carefully inspect your Hansgrohe product for any damage or visible defect. Prior to installing, always carefully study the enclosed instructions on the proper installation and the care and maintenance of the product. If you have questions at any time about the use, installation, or performance of your Hansgrohe product, or this warranty, please call or write to us at the toll-free number and address printed above.

**Hansgrohe Inc.**  
1490 Bluegrass Lakes Parkway  
Alpharetta GA 30004  
770 360 9880  
website: [www.hansgrohe-USA.com](http://www.hansgrohe-USA.com)