

BC4013R0TX-ESPRESSO
BC401400TX-WHITE
BC401500TX-BLACK
"CHELMSFORD" SHOE BENCH
Assembly Instructions



For assistance with assembly contact:
Southern Enterprises, Inc.
Customer Service 1-800-633-5096
service@seidal.com
www.seidal.com

PO#11545

Max seat load: 250 lb.

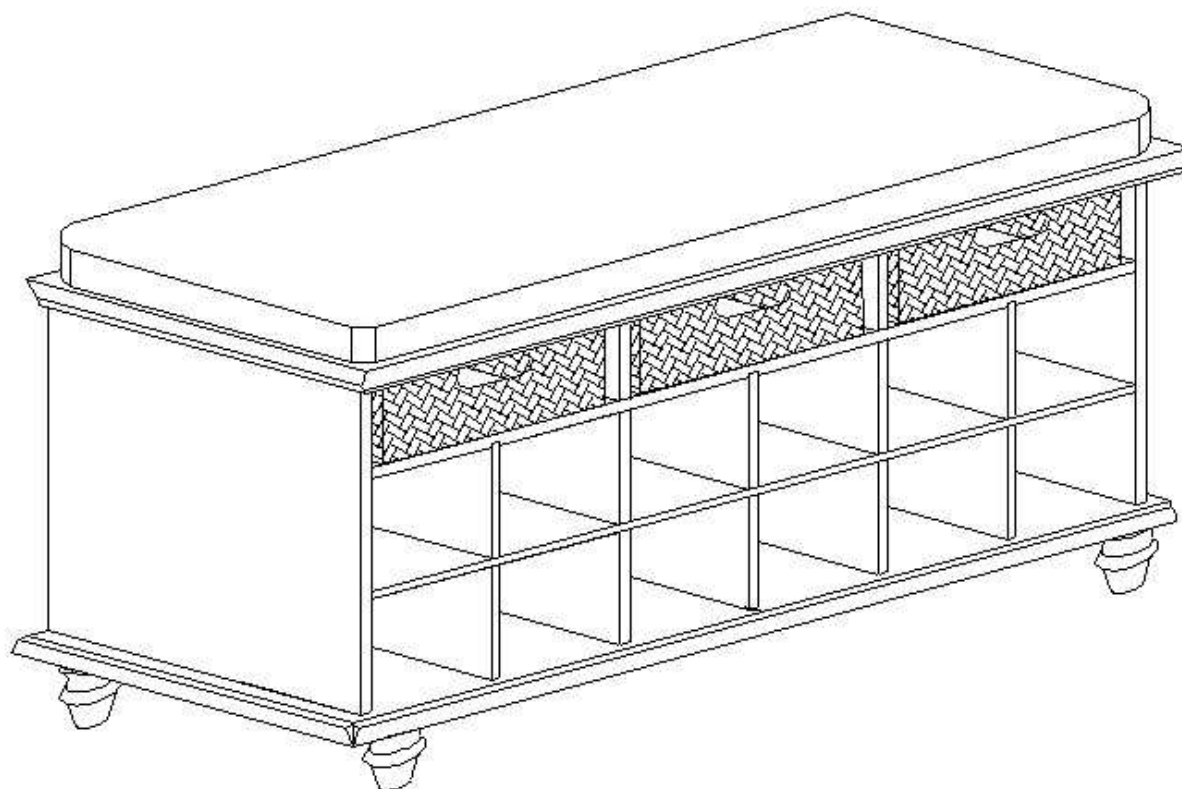

"CHELMSFORD" SHOE BENCH

Parts List

Please review all parts and hardware before disposing of any packaging. Call Customer Service if missing hardware. Do not return to store/retailer. Using a screw that is too long will cause damage. Before beginning assembly, separate each type of screw. Carefully study the screw diagrams below. You may receive extra hardware with your unit.

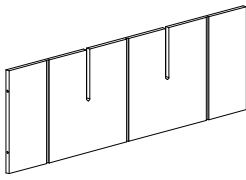
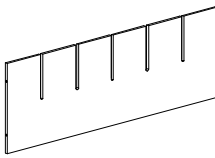
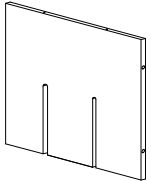
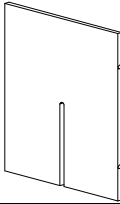
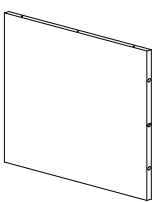
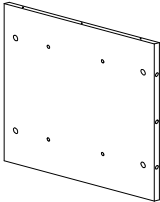
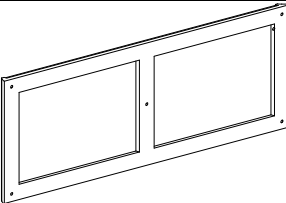
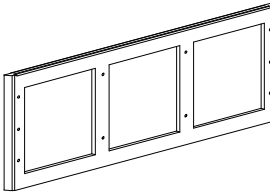
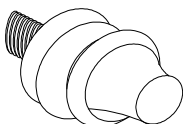
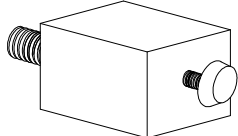
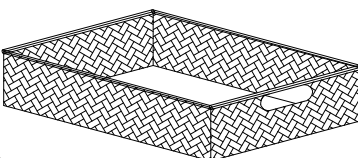
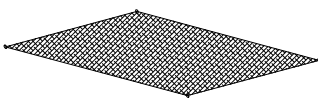
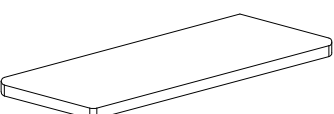
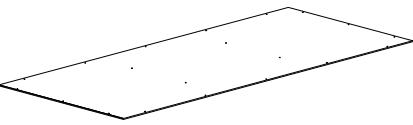
<p>A</p>  <p>Quantity of 1</p> <p>First Shelf Panel</p>	<p>B</p>  <p>Quantity of 1</p> <p>Second Shelf Panel</p>
<p>C</p>  <p>Quantity of 2</p> <p>Big Divider Panel</p>	<p>D</p>  <p>Quantity of 3</p> <p>Small Divider Panel</p>
<p>E</p>  <p>Quantity of 1</p> <p>Right Side Panel</p>	<p>F</p>  <p>Quantity of 1</p> <p>Left Side Panel</p>
<p>G</p>  <p>Quantity of 1</p> <p>Bottom Panel</p>	<p>H</p>  <p>Quantity of 1</p> <p>Top Panel</p>
<p>I</p>  <p>Quantity of 4</p> <p>Leg</p>	<p>J</p>  <p>Quantity of 1</p> <p>Center Support Leg</p>
<p>K</p>  <p>Quantity of 3</p> <p>Basket Frame</p>	<p>L</p>  <p>Quantity of 3</p> <p>Basket Bottom</p>
<p>M</p>  <p>Quantity of 1</p> <p>Cushion</p>	<p>N</p>  <p>Quantity of 1</p> <p>Back Panel</p>
<p>Care and Cleaning Instructions: Before using, wipe with a clean, dry cloth. Periodically apply furniture wax to renew the finish. Avoid rubbing or scratching the surface with rough or abrasive objects.</p>	<p>For replacement parts or questions, please Call Customer Service at 1-800-633-5096 Do not return product to store, please call Manufacturer for assistance, questions or Parts.</p>

Assembly Tool Required
No.2 Phillips Screwdriver (Not Included)

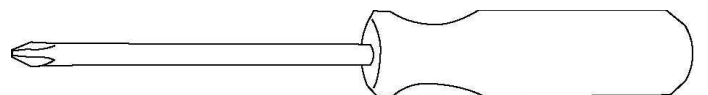

"CHELMSFORD" SHOE BENCH

Parts List

Please review all parts and hardware before disposing of any packaging. Call Customer Service if missing hardware. Do not return to store/retailer. Using a screw that is too long will cause damage. Before beginning assembly, separate each type of screw. Carefully study the screw diagrams below. You may receive extra hardware with your unit.

1 Quantity of 8



Cam Bolt

2 Quantity of 8

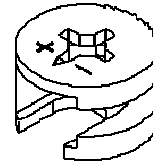

Cam Lock

3 Quantity of 26

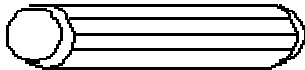

Wood Dowel (Ø5*30mm)

4 Quantity of 20

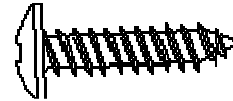

Wood Screw (Ø3*12MM)

5 Quantity Of 8



COTTON MAT

Care and Cleaning Instructions:

Before using, wipe with a clean, dry cloth. Periodically apply furniture wax to renew the finish. Avoid rubbing or scratching the surface with rough or abrasive objects.

For replacement parts or questions, please Call Customer Service at 1-800-633-5096 Do not return product to store, please call Manufacturer for assistance, questions or Parts.

Assembly Tool Required
No.2 Phillips Screwdriver (Not Included)

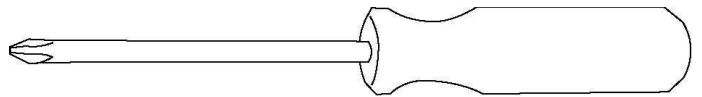

"CHELMSFORD" SHOE BENCH Assembly Instructions

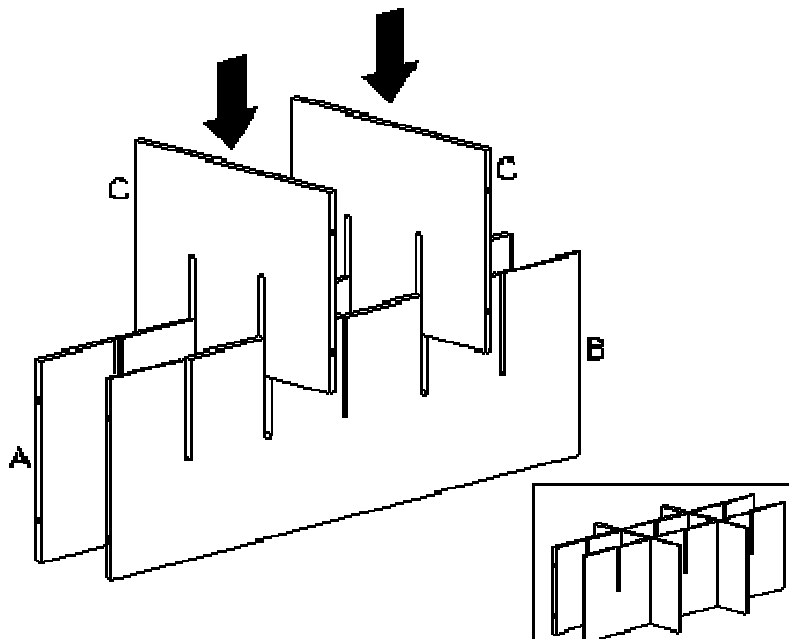

Figure 1

Assembly Instructions:
Wood may scratch easily, Be careful when assembling. Do not scratch.

Step 1 Unpack and lay parts on clean, padded surface like carpet or blanket. Check that you have all parts indicated on the front page.

Step 2 Attach the big divider Panels(C) to the Shelf Panels(A,B) as shown in Figure 1.

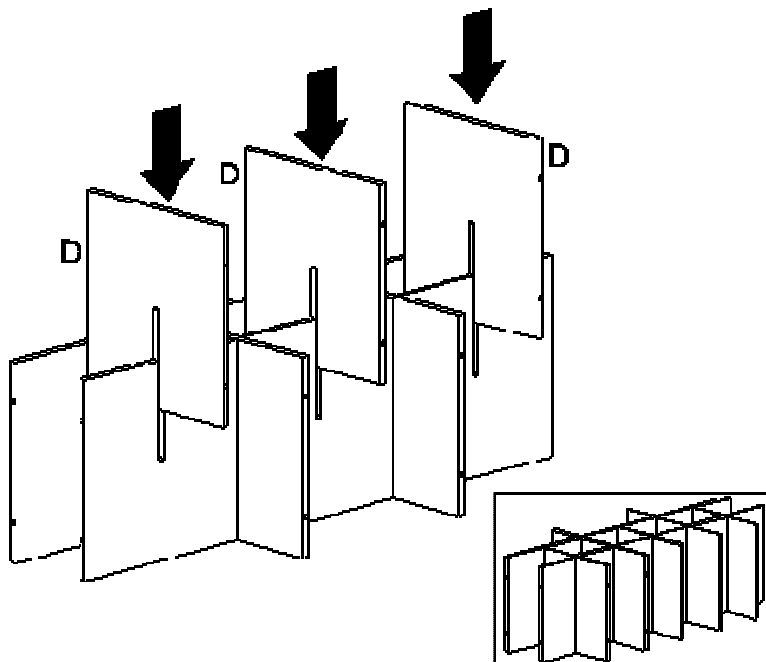

Figure 2

Attach the Small Divider Panels(D) to the Shelf Panels(A,B) as shown in Figure 2.

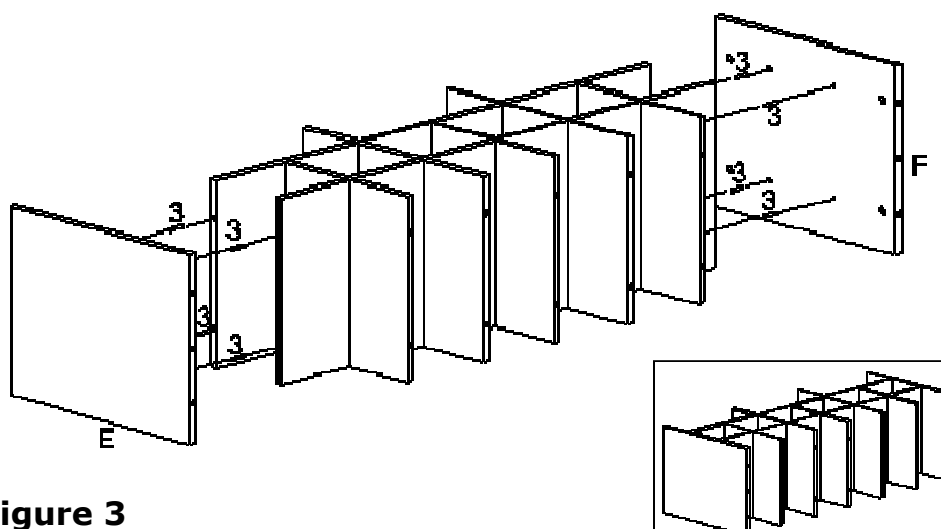
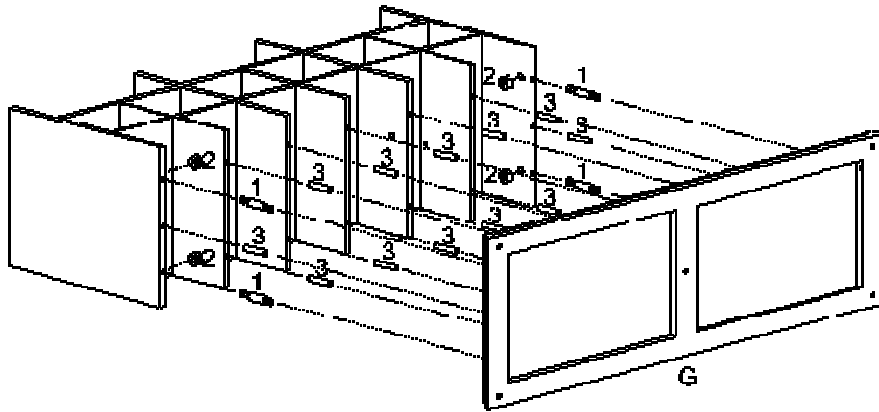

Figure 3

Connect the Right and Left Side Panels(E,F) using 8pcs Wood Dowels(3).

"CHELMSFORD" SHOE BENCH Assembly Instructions



Connect the Bottom Panel(G), using 12pcs Wood Dowels(3), 4pcs Cam Bolts(1) and 4pcs Cam Locks(2).

Figure 4

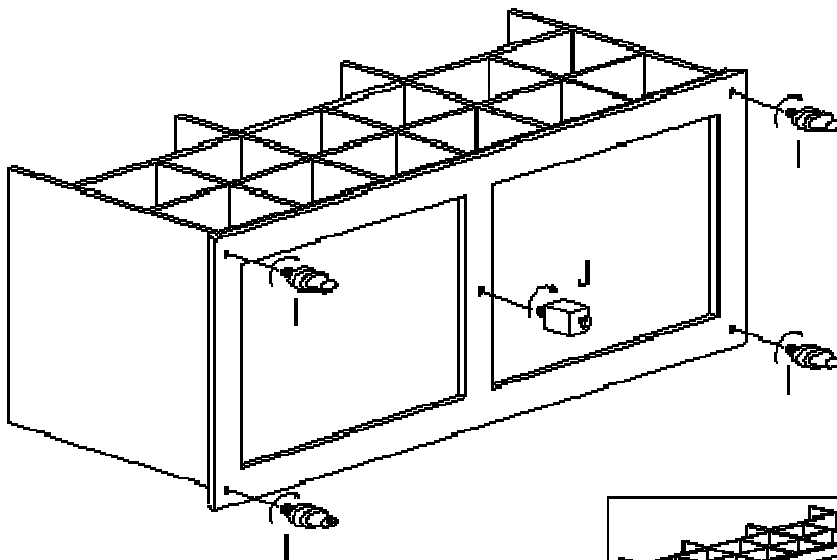

Attach the four Legs(I) and Center Support Leg(J) to the Bottom Frame(G).

Figure 5

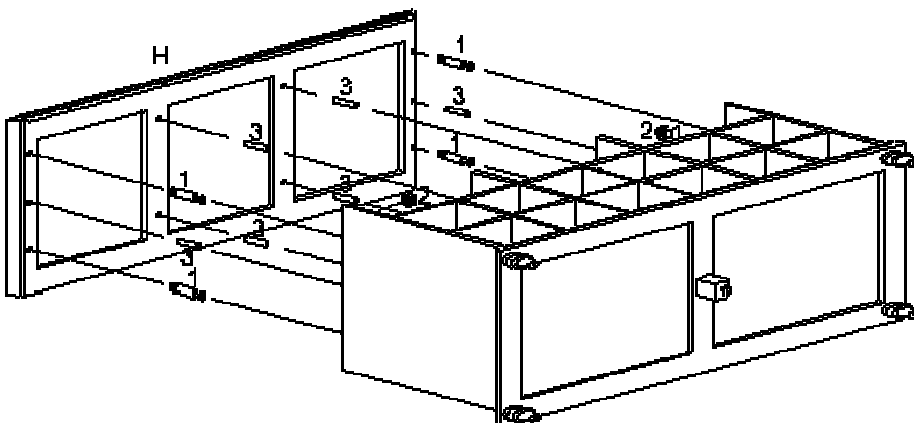

Connect the Top Panel(H) to the assembled unit using 6pcs Wood Dowels(3), 4pcs Cam Bolts(1) and 4pcs Cam Locks(2).

Figure 6

"CHELMSFORD" SHOE BENCH Assembly Instructions

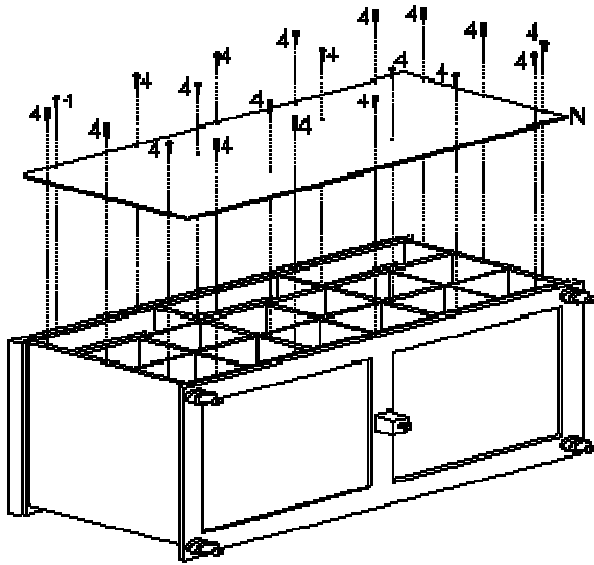

Figure 7

Connect the Back Panel (N) to the assembled unit using 20pcs Wood Screws(4).

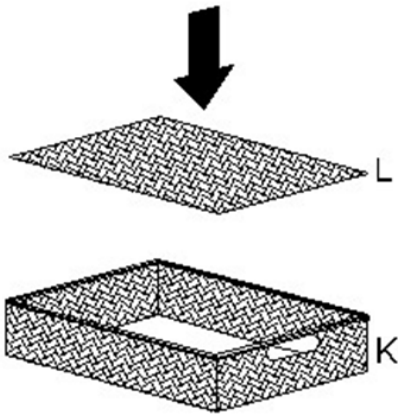

Figure 8

Insert Basket Bottoms(L) into Basket Frames(K).

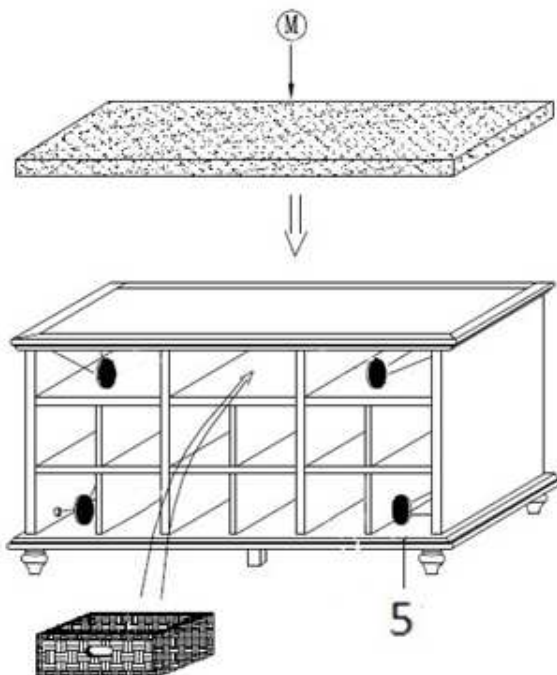

Figure 9

Cover Cam Locks(2) with eight Cotton Mats(5).

Insert wicker baskets.

Put the Cushion(M) on top of assembled bench.

Parts Replacement Form

Customer Information

Name _____

Address _____

City/State/Zip Code _____

Phone Number _____

Please indicate where you purchased this item: Store/Website/Catalog

Please indicate color/size/style number:

Style No	Parts Letter	Parts Description	Quantity Needed
_____	_____	_____	_____
_____	_____	_____	_____
_____	_____	_____	_____

Please immediately examine this product carefully. Any request for missing parts or damage replacement must be received within 90 days of your receipt of the product. Replacement, if available, will be honored within this time frame. Parts will not be available for items arriving fully assembled. We do not recommend modifying product(s) and we are not responsible for any damages due to product modification(s). If damages or missing parts are not reported within 90 days of your receipt, we are under no obligation to provide parts or replacement merchandise.

Please contact Southern Enterprises at 800-633-5096 or in Dallas 972-869-0111/ 9am – 4pm Mon-Fri Central time if you have product issues or email us at service@seidal.com. Please ask for customer service representative for issues involving damages or replacement parts. Please ask for technical assistance representative for any issues with product and assembly/construction.

Please contact the retailer that you purchased from for returns.



Customer Service 1-800-633-5096
service@seidal.com
Southern Enterprises, Inc.
600 Freeport Parkway, Suite 200
Coppell, Texas 75019