

**VELUX®**

---

**FHLC/FHLD  
FHCC/FHCD**



VAS 453787-2014-07

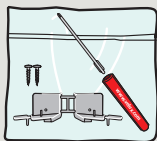
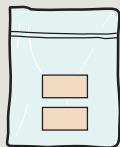
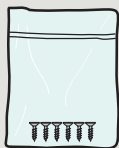
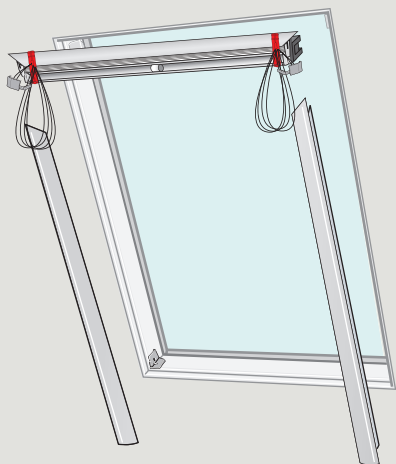

  
Ø 1/16" / 1.5 mm

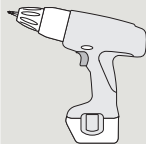

1

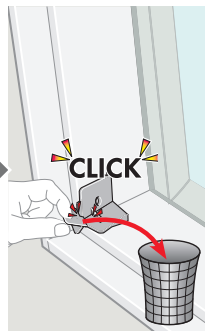
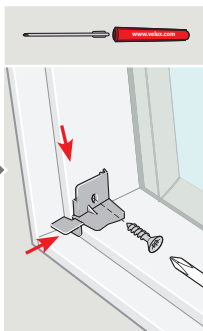
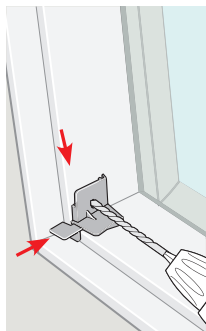
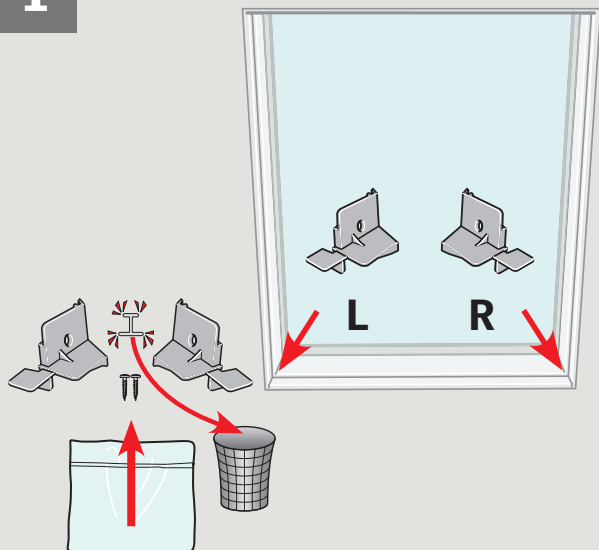

**ENGLISH:** Installation of the blind can be done in two ways:

- A** With most skylights, the top part and the sides of the blind are installed individually – see pages 6-7.
- B** With skylight **FS** in the sizes listed, the blind must be partially assembled before installation in the skylight – see pages 8-9.

**ESPAÑOL:** La instalación de la persiana puede hacerse de dos maneras:

- A** Con la mayoría de los tragaluces, la parte superior y los lados de la persiana se instalan de manera individual. Consulte las páginas 6-7.
- B** Con el tragaluz **FS** en los tamaños mencionados, la persiana debe ensamblarse parcialmente antes de instalarla en el tragaluz. Consulte las páginas 8-9.

**FRANÇAIS :** Installation du store peut être effectué de deux manières :

- A** Pour la plupart des puits de lumières, la partie supérieur et les côtés de store sont installés individuellement – voir pages 6-7.
- B** Pour le puits de lumière **FS** dans les tailles indiquées, le store doit être partiellement assemblé avant l'installation dans le puits de lumière – voir pages 8-9.

**日本語:** ブラインドの取り付けには以下の2方式があります。

- A** ほとんどの天窓では、ブラインド本体と左右のレールを別々に取り付けます。 - 6-7ページ参照。
- B** FSフィックスタイプで表のサイズの場合は、ブラインド本体と左右のレールを、図のように仮組をしてから取り付けます。 - 8-9ページ参照。

# A

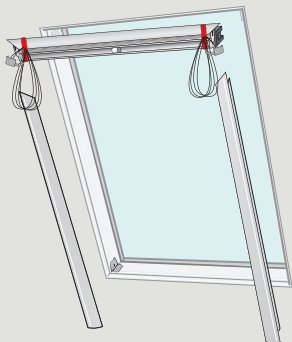

Pages  
6-7

# B

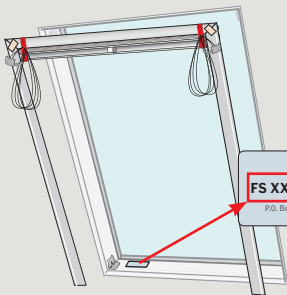

**VELUX®**  
FS XXX XXXX XXXXXXXX  
P.O. Box 5001, Greenwood, SC 29648  
Made in U.S.A.

FS A06  
FS C01  
FS D26  
FS M25  
FS S25  
FS S01



Pages  
8-9

2A

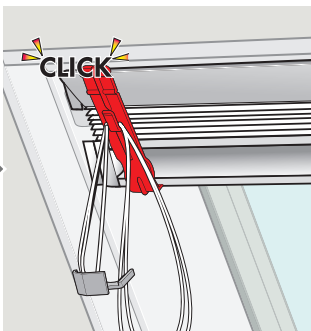
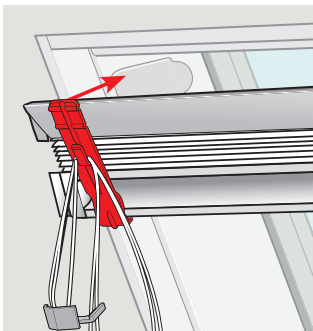
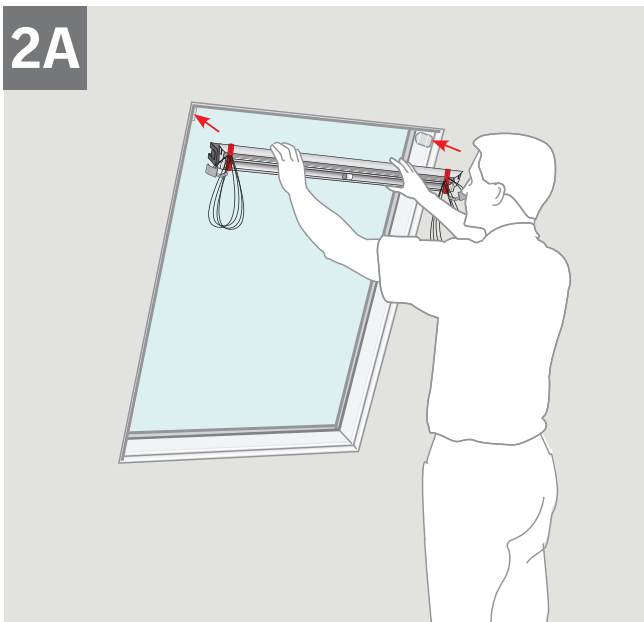

# 3A

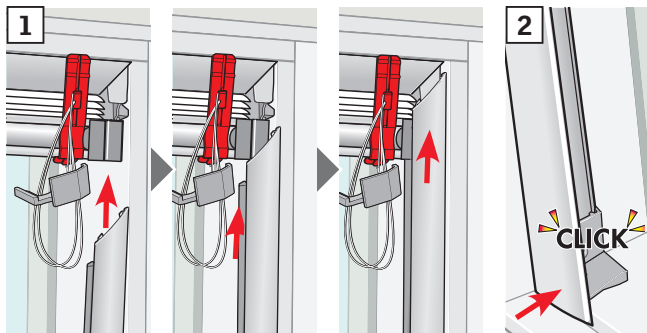
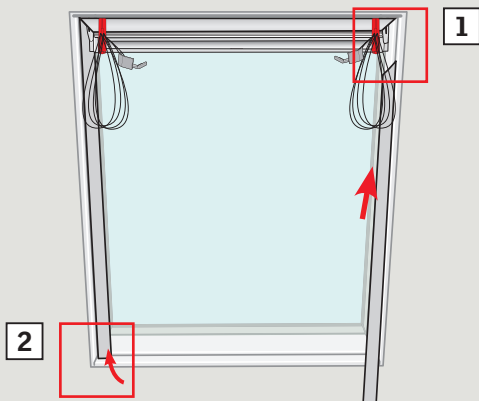

# 2B

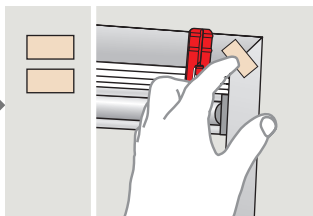
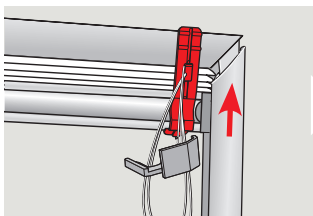
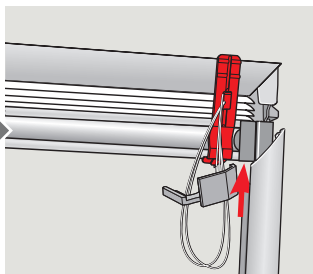
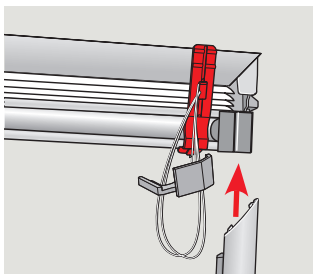
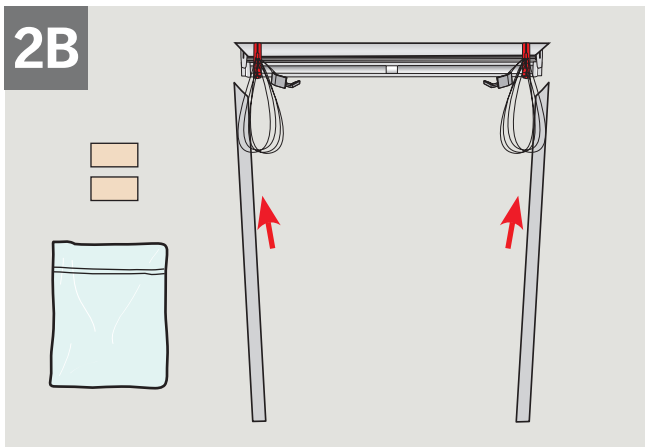



**3B**

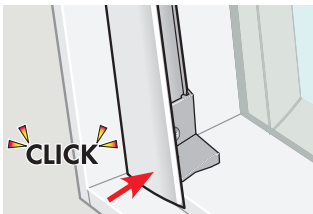
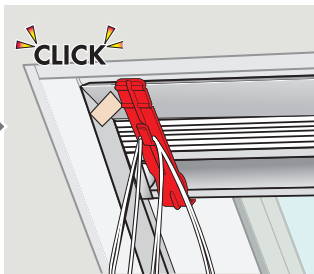
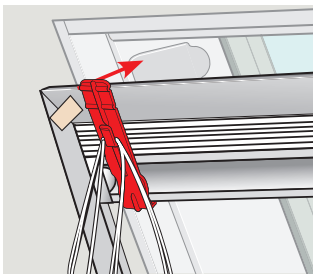
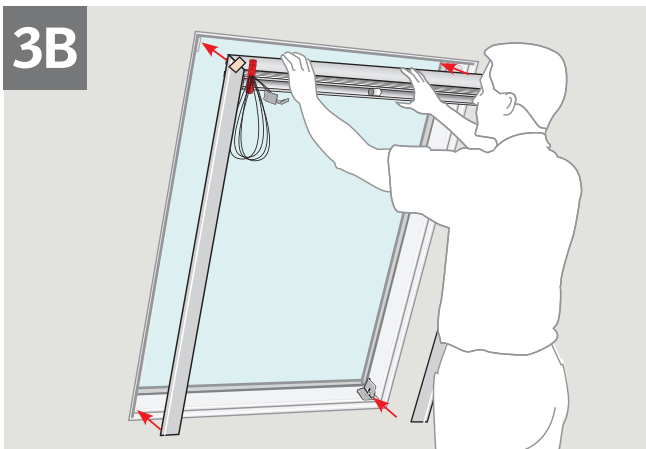

4

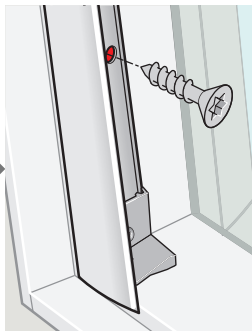
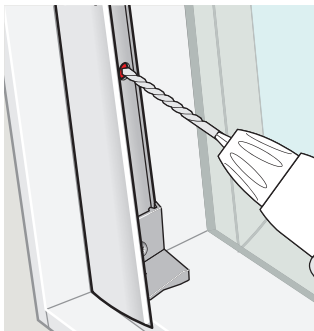
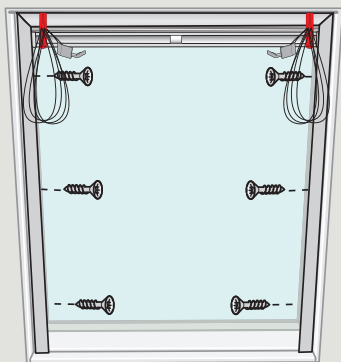
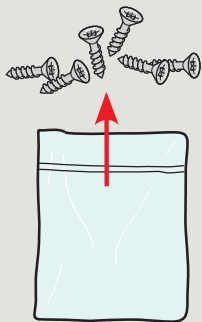

5

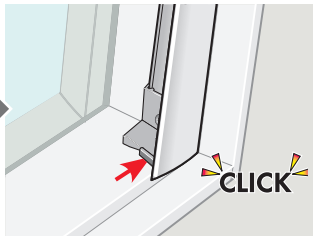
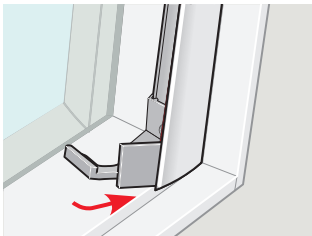
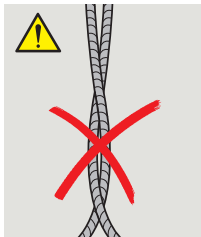
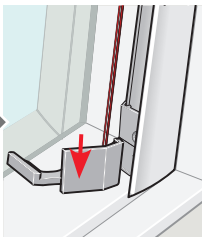
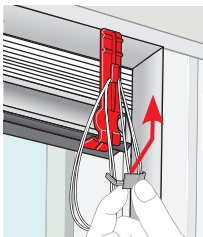
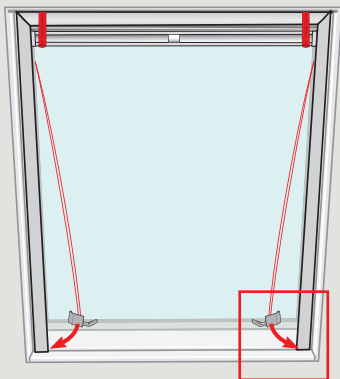

6

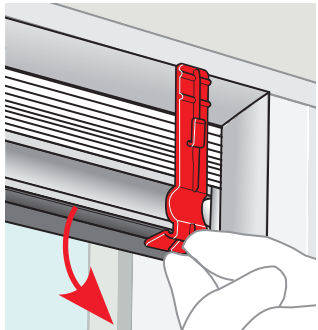
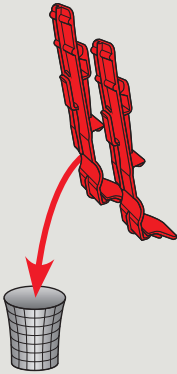
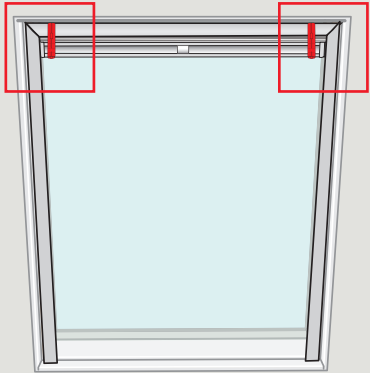





**ZXT 200**

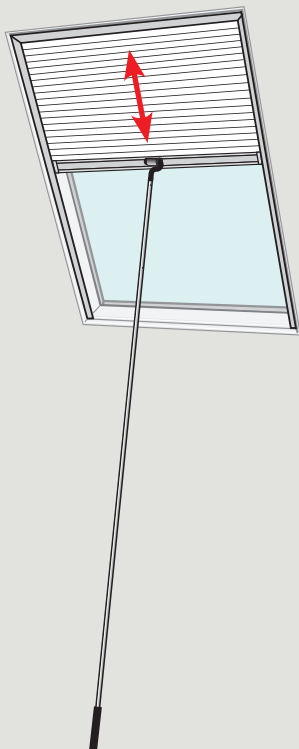

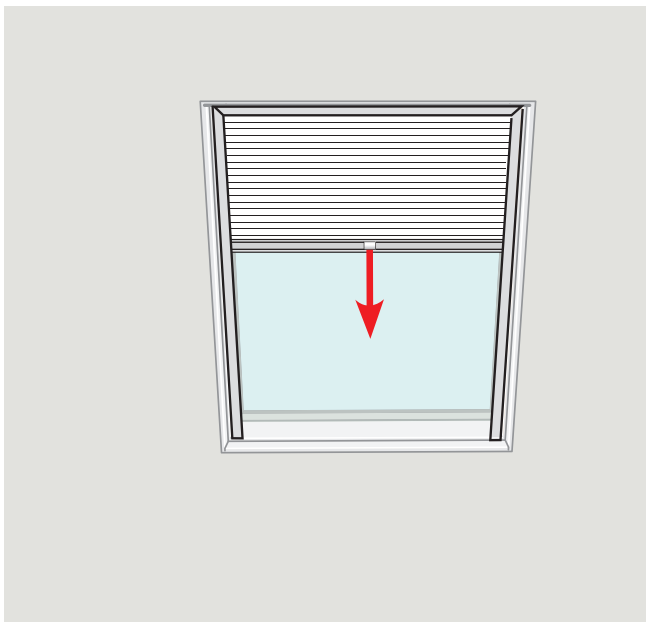

The logo consists of the word "VELUX" in a bold, white, sans-serif font, with a registered trademark symbol (®) to its upper right. The text is centered within a solid red rectangular background.

- US:** VELUX America Inc.  
1-800-88-VELUX
- CD:** VELUX Canada Inc.  
1 800 88-VELUX (888-3589)
- AU:** VELUX Australia Pty. Ltd  
1300 859 856
- NZ:** VELUX New Zealand Ltd.  
0800 650 445
- JP:** VELUX-Japan Ltd.  
0570-00-8145

[www.velux.com](http://www.velux.com)