

WYNDHAM COLLECTION

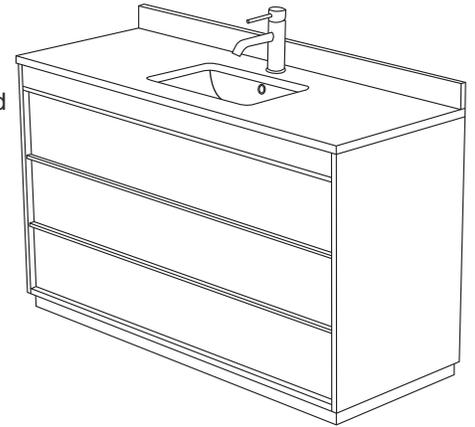
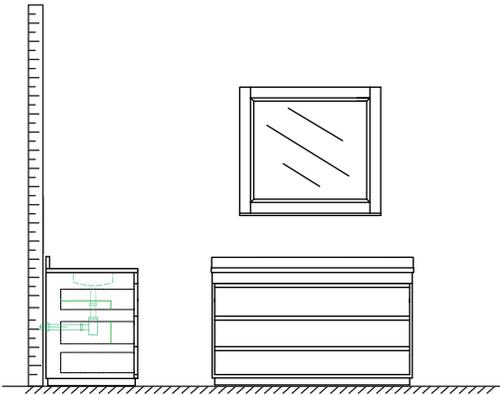

- Prior to installation please check received items against the "Packing List". Please report any missing items to your retailer immediately.
- Protect all surfaces from sharp objects, high heat sources, direct prolonged sunlight and chemical hazards.
- Professional installation recommended.

PACKING LIST

(Not all components may be included, depending on your purchase)

OPTIONAL

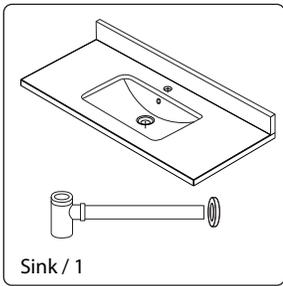

OPTIONAL

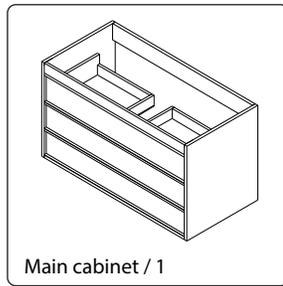

OPTIONAL

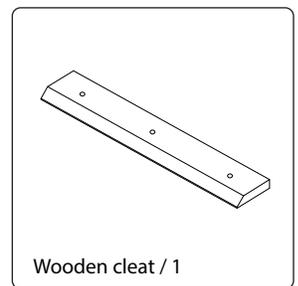

OPTIONAL

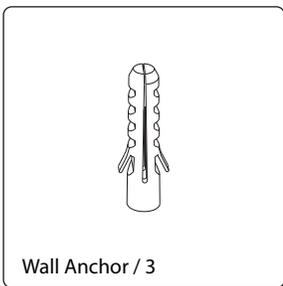

OPTIONAL

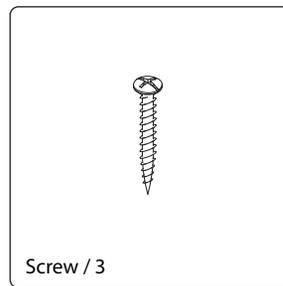

OPTIONAL

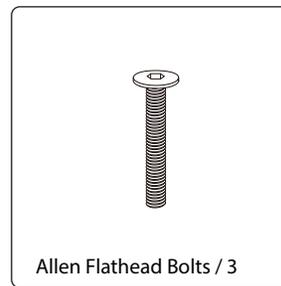

REQUIRED TOOLS NOT IN BOX

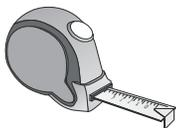

Tape Measure



Pencil



Electric Drill

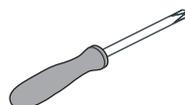

Phillips Screwdriver



Allen Key (5-32)



Spirit Level



Silicone Sealant

WC-1818-48
INSTALLATION-GUIDE

WYNDHAM COLLECTION

INSTALLATION INSTRUCTIONS

- ① Attach counter to cabinet with silicone sealant applied to top of front and side cabinet edges. Do not over apply. Allow to dry for 24 hours for proper curing.

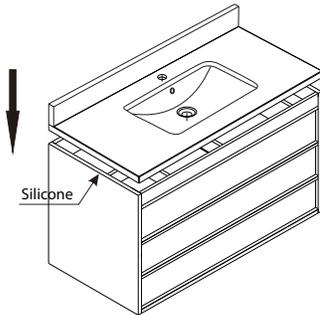

- ② Licensed professional installation recommended. Other installation techniques may require a licensed professional.

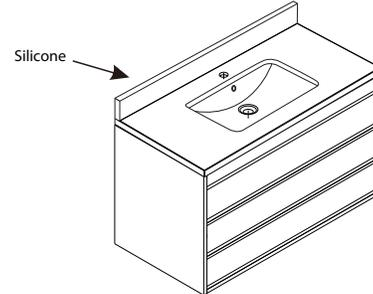

- ③ Place flathead bolts through existing holes on mirror shelf. Attach to bottom of mirror frame and use Allen key to tighten bolts until shelf is securely fastened to mirror frame.

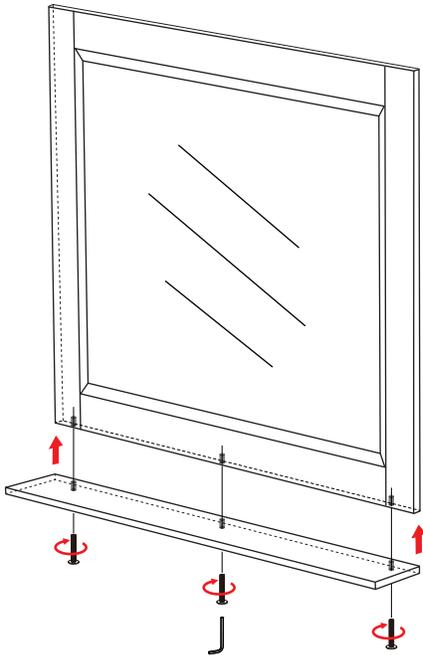

- ④ Drill holes in wall and gently tap anchors into the holes.

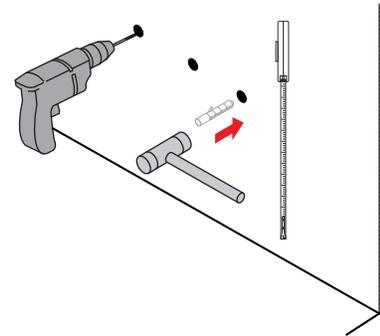

- ⑤ Place wooden cleat flat onto wall, carefully lining it up with the holes. Next, use the screws provided to fasten cleat onto the wall.

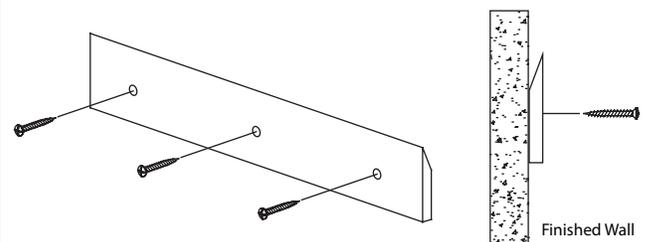

WC-1818-48
INSTALLATION-GUIDE

WYNDHAM COLLECTION

MIRROR INSTALLATION INSTRUCTIONS

- ⑥ Hang mirror by placing top rail/cleat directly onto the wall cleat, matching the angle of the slant.

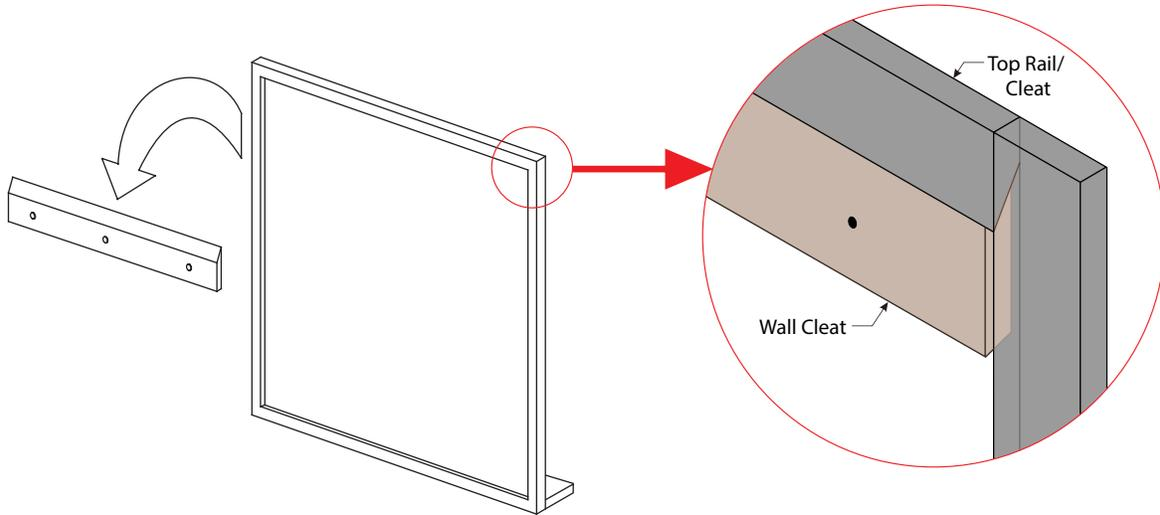

WC-1818-48
INSTALLATION-GUIDE