



HardieShingle® Siding

SINGLE FAMILY INSTALLATION REQUIREMENTS

EFFECTIVE APRIL 2018

IMPORTANT: FAILURE TO FOLLOW JAMES HARDIE WRITTEN INSTALLATION INSTRUCTIONS AND COMPLY WITH APPLICABLE BUILDING CODES MAY VIOLATE LOCAL LAWS, AFFECT BUILDING ENVELOPE PERFORMANCE AND MAY AFFECT WARRANTY COVERAGE. FAILURE TO COMPLY WITH ALL HEALTH AND SAFETY REGULATIONS WHEN CUTTING AND INSTALLING THIS PRODUCT MAY RESULT IN PERSONAL INJURY. BEFORE INSTALLATION, CONFIRM YOU ARE USING THE CORRECT HARDIEZONE® PRODUCT INSTRUCTIONS BY VISITING HARDIEZONE.COM OR CALL 1-866-942-7343 (866-9-HARDIE)

STORAGE & HANDLING:

Store flat and keep dry and covered prior to installation. Installing siding wet or saturated may result in shrinkage at butt joints. Carry planks on edge. Protect edges and corners from breakage. James Hardie is not responsible for damage caused by improper storage and handling of the product.

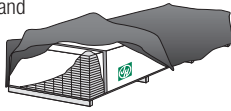

CUTTING INSTRUCTIONS

OUTDOORS

1. Position cutting station so that airflow blows dust away from the user and others near the cutting area.
2. Cut using one of the following methods:
 - a. Best: Circular saw equipped with a HardieBlade® saw blade and attached vacuum dust collection system. Shears (manual, pneumatic or electric) may also be used, not recommended for products thicker than 7/16 in.
 - b. Better: Circular saw equipped with a dust collection feature (e.g. Roan® saw) and a HardieBlade saw blade.
 - c. Good: Circular saw equipped with a HardieBlade saw blade.

INDOORS

DO NOT grind or cut with a power saw indoors. Cut using shears (manual, pneumatic or electric) or the score and snap method, not recommended for products thicker than 7/16 in.

- DO NOT dry sweep dust; use wet dust suppression or vacuum to collect dust.
- For maximum dust reduction, James Hardie recommends using the "Best" cutting practices. Always follow the equipment manufacturer's instructions for proper operation.
- For best performance when cutting with a circular saw, James Hardie recommends using HardieBlade® saw blades.
- Go to jameshardiepros.com for additional cutting and dust control recommendations.

IMPORTANT: The Occupational Safety and Health Administration (OSHA) regulates workplace exposure to silica dust. For construction sites, OSHA has deemed that cutting fiber cement with a circular saw having a blade diameter less than 8 inches and connected to a commercially available dust collection system per manufacturer's instructions results in exposures below the OSHA Permissible Exposure Limit (PEL) for respirable crystalline silica, without the need for additional respiratory protection.

If you are unsure about how to comply with OSHA silica dust regulations, consult a qualified industrial hygienist or safety professional, or contact your James Hardie technical sales representative for assistance. James Hardie makes no representation or warranty that adopting a particular cutting practice will assure your compliance with OSHA rules or other applicable laws and safety requirements.

GENERAL REQUIREMENTS:

- HardieShingle panels can be installed over braced wood or steel studs, 20 gauge (33 mils) minimum to 16 gauge (54 mils) maximum, spaced a maximum of 24 in o.c. or directly to minimum 7/16 in thick OSB sheathing. See General Fastening Requirements. Irregularities in framing and sheathing can mirror through the finished application. Correct irregularities before installing siding.
- Information on installing James Hardie products over non-nailable substrates such as gypsum, foam, etc. can be located in JH Tech Bulletin 19 at www.jamehardie.com
- A water-resistive barrier is required in accordance with local building code requirements. The water-resistive barrier must be appropriately installed with penetration and junction flashing in accordance with local building code requirements. James Hardie will assume no responsibility for water infiltration. James Hardie does manufacture HardieWrap® Weather Barrier, a non-woven non-perforated housewrap¹, which complies with building code requirements.
- When installing James Hardie® products all clearance details in figs. 1 thru 14 must be followed.
- Adjacent finished grade must slope away from the building in accordance with local building codes - typically a minimum of 6 in in the first 10ft.
- Do not install James Hardie products, such that they may remain in contact with standing water.
- HardieShingle panels may be installed on vertical wall applications only.
- DO NOT use stain, oil/alkyd base paint, or powder coating on James Hardie® Products.
- James Hardie Building Products provides installation/wind load information for buildings with a maximum mean roof height of 85 feet. For information on installations above 60 feet, please contact JH technical support.



¹For additional information on HardieWrap® Weather Barrier, consult James Hardie at 1-866-4Hardie or www.hardiewrap.com





CLEARANCE AND FLASHING REQUIREMENTS

Figure 1
Roof to Wall

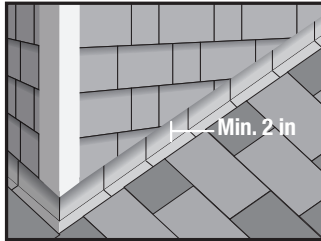

Figure 2
Horizontal Flashing

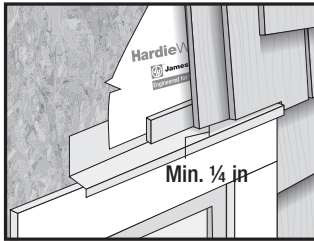

Figure 3
Kickout Flashing

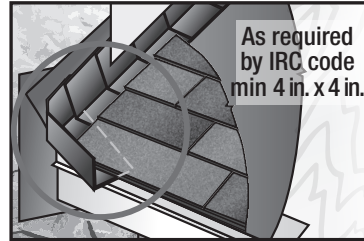

Figure 4
Slabs, Paths, Steps to Siding

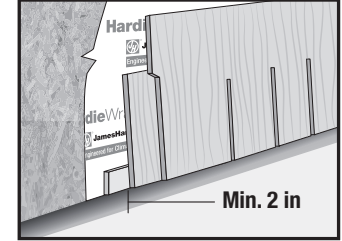

Figure 7
Deck to Wall

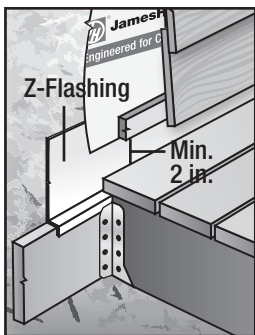

Figure 8
Ground to Siding

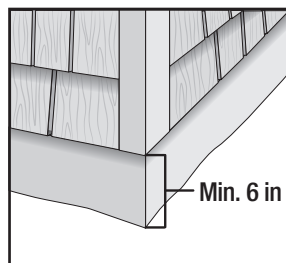

Figure 9
Gutter to Siding

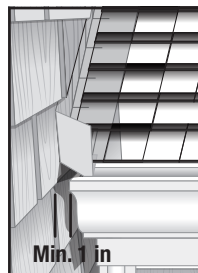

Figure 10
Sheltered Areas

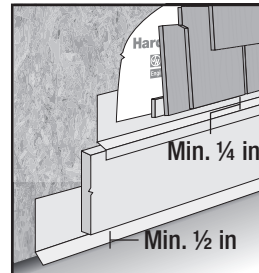

Figure 11
Mortar/Masonry

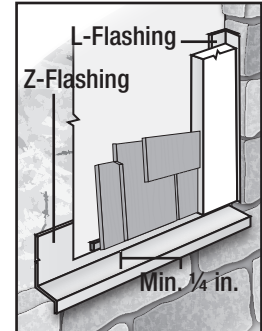

Figure 12
Drip Edge

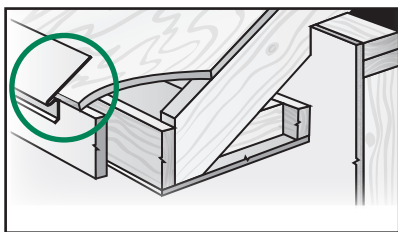

Figure 13
Block Penetration

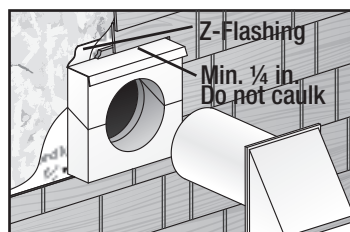

Figure 14
Valley/Shingle Extension

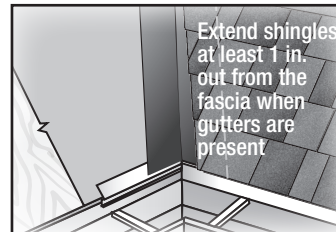

Figure 15A

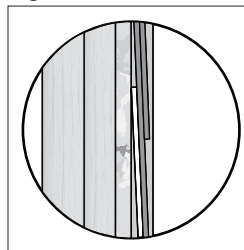

Figure 15B

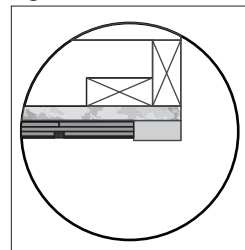

Figure 15C

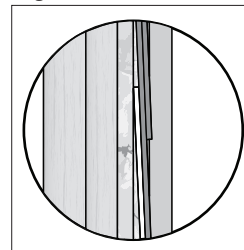
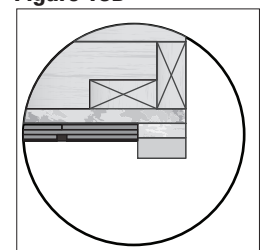

Figure 15D



TRIM CONSIDERATION:

Minimum 1 in trim thickness is needed as Panels stack at a depth of roughly 15/16 in for the 7 in reveal. If additional trim depth is desired, you can place a spacer under the trim (Fig. 15C & 15D). DO NOT install trim over HardieShingle.

GABLE INSTALLATION:

Installation over sheathing is recommended (Required for Individuals) for gables.*

- 1) Find the center stud of your of your Gable and snap a chalk line down
- 2) Measure out 16 in* to both the left and the right of the center line and snap a chalk line
- 3) Measure up 2 in if you are off a roof line or ¼ in if you are starting above a band board
- 4) Set the bottom of your 1 ¼ in starter strip at that line
- 5) Place your 8 ¼ in Starter Course -bottom level with the bottom of the starter strip
- 6) Set your first row of Shingle - starting the first piece at the vertical line left of center
(If you are using staggered edged shingles Trim down the first row to the shortest shingle length)
- 7) Drive nails approximately ¼ in above Key ways 5 per full panel Center Nail can be either one of the keyways.
(Stay by keyway to avoid shiners) (EX1) Blue Dots show nail placement
- 8) Measure up 7 in with straight and 6 in with Staggered edge and snap a chalk line to get your proper exposure
- 9) The second row will start at the center line
- 10) The Third row will start at the line right of center
- 11) As you work your way up the gable make sure you Keep your Cut Pieces you will use the pieces on the edges of the gable (EX2)
- 12) Edges Gable butting into trim leave a 1/8 in Gap (for house movement and Caulking)
- 13) Make sure to sure siding nails on the small pieces on the edges (Do not use a trim nail to install!)

Figure 16

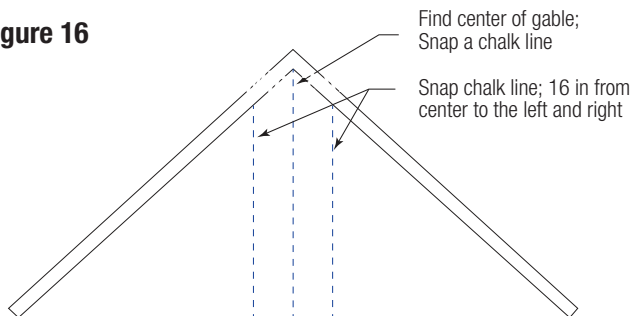

Figure 17

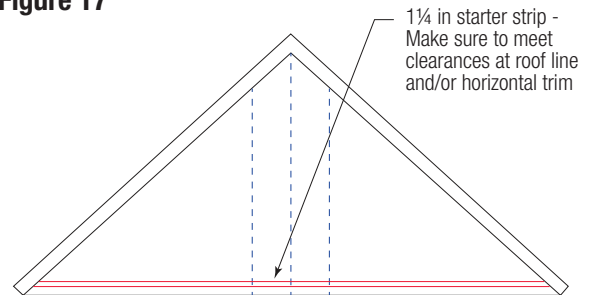

Figure 18

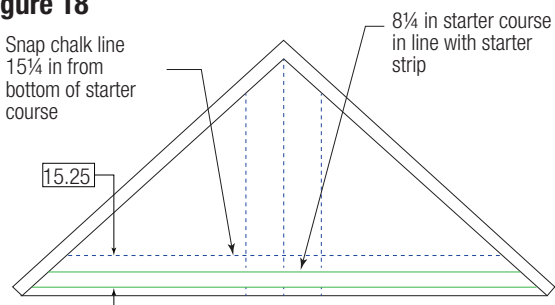

Figure 19

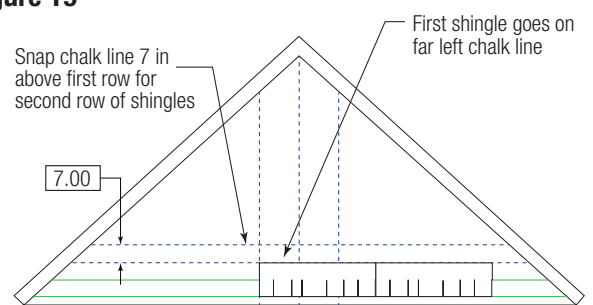

Figure 20

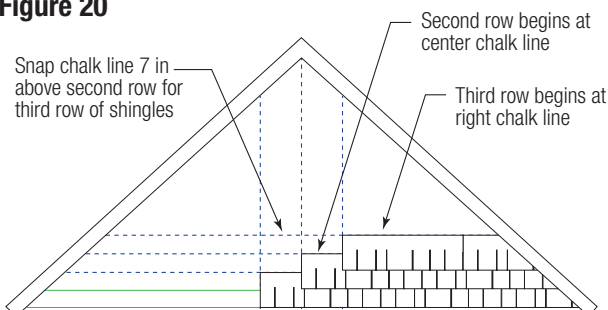
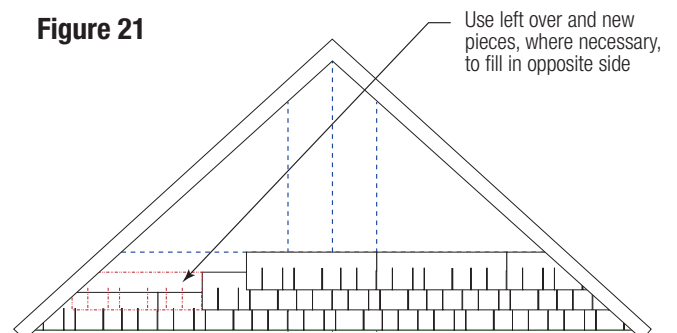

Figure 21



*Panels can also be installed direct to stud up to 24 in OC.

Note: Snapped chalk lines help guide installation, when installing straight edge panels or Individual shingles use a straight edge on bottom edges if uniform straight edge is desired.



HARDIESHINGLE STAGGERED EDGE PANELS INSTALLATION

Fastener Requirements

0.083 in x 0.187 in HD x 1 1/2 in long ringshank nails are used for fastening HardieShingle® Staggered Edge Panels to both framing and to 7/16 in thick APA rated sheathing.

HardieShingle® Staggered Edge Panel Installation

Install HardieShingle® panels with joints butted in moderate contact. Due to overlapping of the joints, caulk is not required except where panels abut trim boards. (fig. 22 & 24). Ensure keyways do not line up on subsequent courses.

- 1) Install a 1-1/4 in starter strip, then install a 8-1/4 in wide HardiePlank® lap siding starter course.
- 2) Place first panel so that panel end centers over stud. Trim panel as needed. Butt the cut end into trim as shown (figs 22 & 24). When installing over a band board or any horizontal surface, leave 1/4 in gap between bottom of siding and flashing.
- 3) Secure panel, leaving 1/8 in gap for caulk at trim and continue the course along the wall.
- 4) Start the second course, by removing the equivalent of one full stud cavity (16 in or 24 in OC), again abutting the cut end into the trim (figs 22 & 24). This is to prevent pattern repetition. Repeat step 3.
- 5) Start the third course, by removing the equivalent of two full stud cavities (figs 22 & 24) and repeat step 3.
- 6) Continue up the wall repeating steps 2 through 6 until desired height is reached.

Note: For aesthetic purposes you may trim the bottom of the panel to create a straight edge. If doing so, ensure all cuts ends are properly sealed and painted (fig 23)

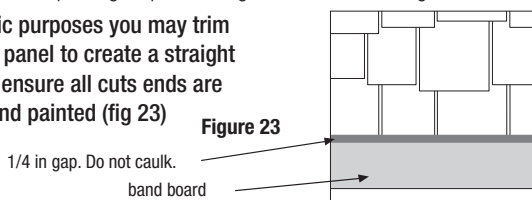
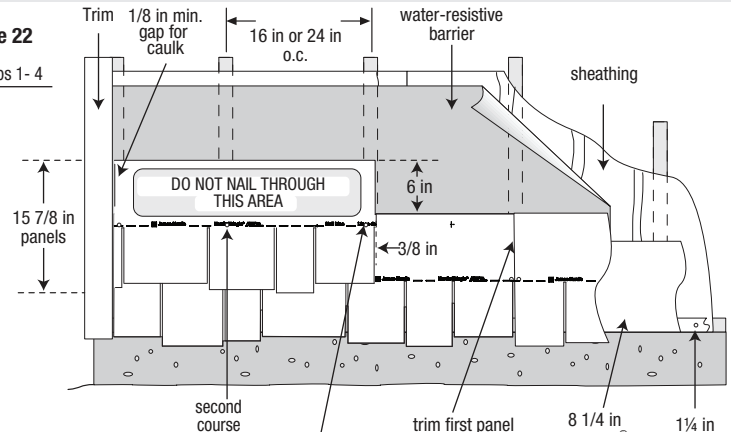

Figure 23

Figure 22

Steps 1-4



position nails on nail line and secure into framing. Only when application is to minimum 7/16 in thick APA rated sheathing, position nails on nail line spaced a maximum of 13 3/4 in o.c. Allow 3/8 in from panel edges.

Steps 5 & 6

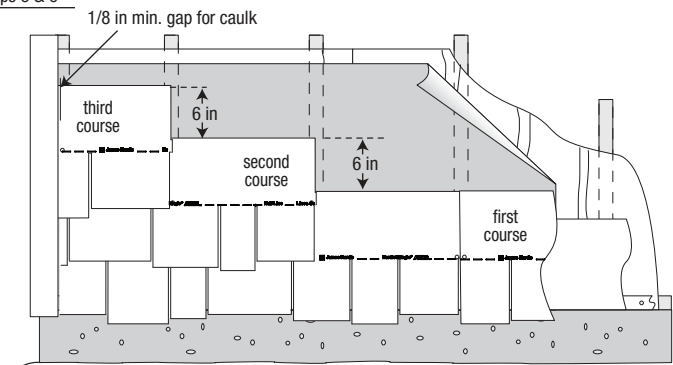

HARDIESHINGLE STAGGERED EDGE PANEL COVERAGE

Panels for sidewall applications are available in 48 in lengths. Pieces needed for one square (100sq.ft.) of product coverage = approximately 50, based on a maximum 6 in exposure from the top edge of HardieShingle panels in subsequent courses (refer to Figure 22).

7 IN EXPOSURE HARDIESHINGLE STRAIGHT EDGE PANELS INSTALLATION (For 5 in exposure product please go to page 7)

Maximum Exposure of 7 in

REFER TO STAGGERED EDGE INSTRUCTIONS ABOVE

Steps 1 - 4

Figure 24

Steps 5 & 6

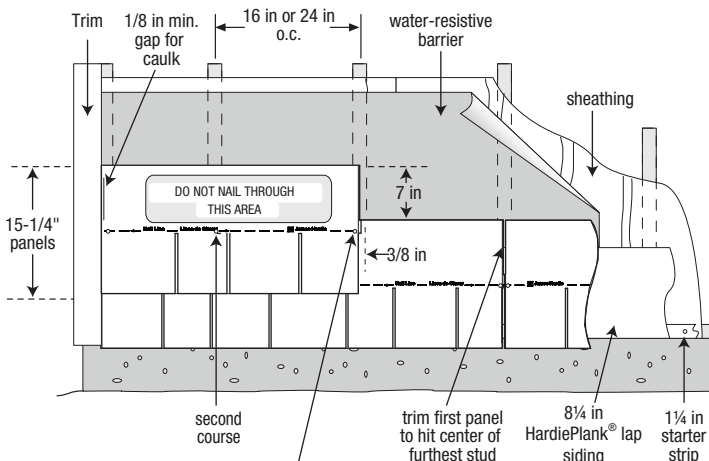

position nails on nail line and secure into framing. Only when application is to minimum 7/16 in thick APA rated sheathing, position nails on nail line spaced a maximum of 13 3/4 in o.c. Allow 3/8 in from panel edges.

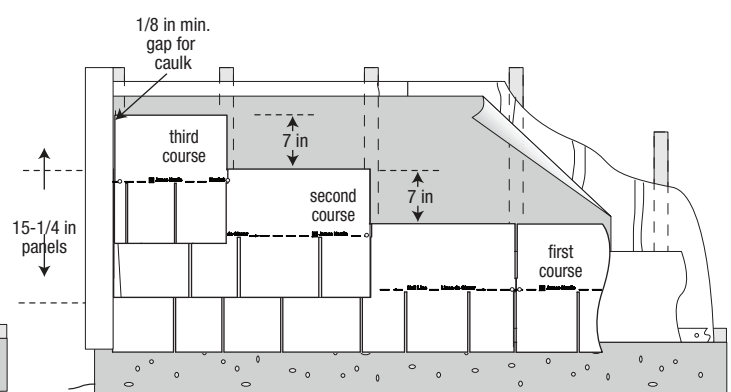

HARDIESHINGLE STRAIGHT EDGE PANEL COVERAGE

Panels for sidewall applications are available in 48 in lengths. Pieces needed for one square (100sq.ft.) of product coverage = approximately 43, based on maximum 7 in exposure.



HARDIESHINGLE INDIVIDUAL SHINGLE INSTALLATION

HardieShingle Individual Shingles must be installed with the widest part of the shingle placed downwards and directly to minimum 7/16 in thick sheathing.

Fastener Requirements

0.091 in x 0.221 in HD x 1 1/2 in or 0.121 in x 0.371 in HD x 1 1/4 in long corrosion resistant siding nails are used for fixing HardieShingle siding to 7/16 in thick APA rated sheathing.

HardieShingle Individual Shingle Installation

Due to overlapping of the joints, caulk is not required except where panels butt trim boards. Space shingles a maximum 1/4 in apart and leave a minimum lap of 1 1/2 in between successive courses (fig. 26).

- 1) Install 1 1/4 in starter strip and a 8 1/4 in wide HardiePlank siding starter course.
- 2) Install first shingle from the end abutting trim. Install widest part of shingle placed downwards. (fig. 25).
- 3) Secure shingle, leaving a 1/8 in gap for caulk at trim and continue the course along the wall.
- 4) Start the second course, leaving a minimum lap of 1 1/2 in between successive courses, again from the end abutting the trim. Repeat step 3.
- 5) Continue up the wall repeating steps 2 through 5 until desired height is reached.

Figure 25

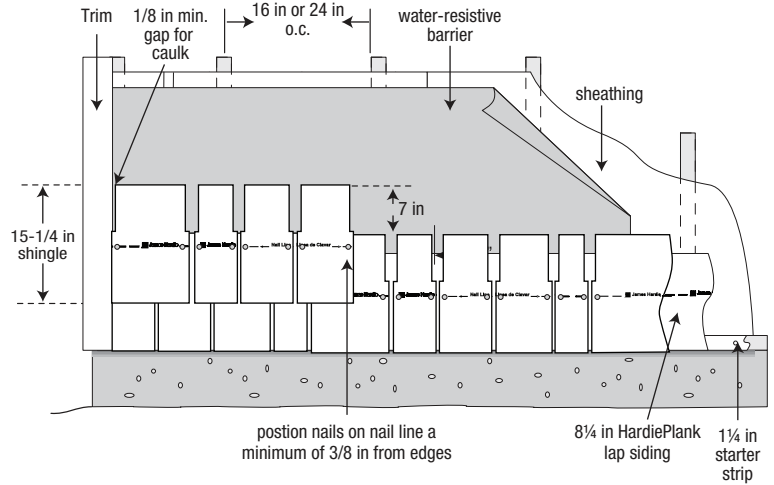
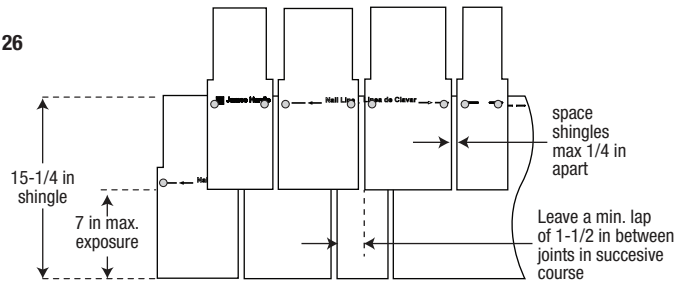

Figure 26



! Install with the widest part of the shingle placed downwards

HARDIESHINGLE INDIVIDUAL SHINGLE COVERAGE

Individual Shingles for sidewall applications are available in assorted widths as listed below. Bundles needed for one square (100 sq. ft.) of product coverage:

Shingle Width	Number of Bundles	Pieces per Bundle
4-3/16 in	3	15
5-1/2 in	6	15
6-3/4 in	3	15
7-1/4 in	6	15
10 in	3	15

HARDIESHINGLE HALF-ROUND PANELS INSTALLATION

Fastener Requirements

0.083 in x 0.187 in HD x 1 1/2 in long ringshank nails are used for fastening HardieShingle Half-Round Panels to both framing and to 7/16 in thick APA rated sheathing.

HardieShingle Half-Round Panel Installation

Install HardieShingle panels with joints butted in moderate contact. Due to overlapping of the joints, caulk is not required except where panels abutt trim boards. (fig. 27). Ensure keyways do not line up on subsequent courses.

- 1) Install a 1-1/4 in starter strip, then install a 8-1/4 in wide HardiePlank lap siding starter course.
- 2) Place first panel so that panel end centers over stud. Trim panel as needed. Butt the cut end into trim as shown (figs 27). When installing over a band board or any horizontal surface, leave 1/4 in gap between bottom of siding and flashing.
- 3) Secure panel, leaving 1/8 in gap for caulk at trim and continue the course along the wall.
- 4) Start the second course, by removing the equivalent of one full stud cavity (16 in or 24 in OC), again abutting the cut end into the trim (fig 27). This is to prevent pattern repetition. Repeat step 3.
- 5) Start the third course, by removing the equivalent of two full stud cavities (figs 28 & 30) and repeat step 3.
- 6) Continue up the wall repeating steps 2 through 6 until desired height is reached.

Figure 27

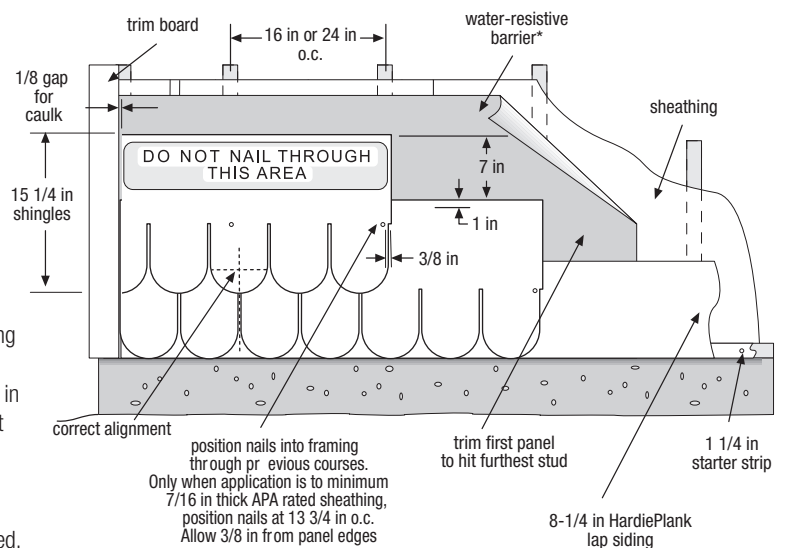

HARDIESHINGLE HALF-ROUND PANEL COVERAGE

Panels for sidewall applications are available in 48 in lengths. Pieces needed for one square (100 sq. ft.) of product coverage=43 pieces with 7 in exposure.



CORNER DETAILS

- A. Panels butted against corner boards.
- B. Panels butted against square wood strip on inside corner, flashing behind.
- C. Laced outside corner.
- D. Laced inside corner.

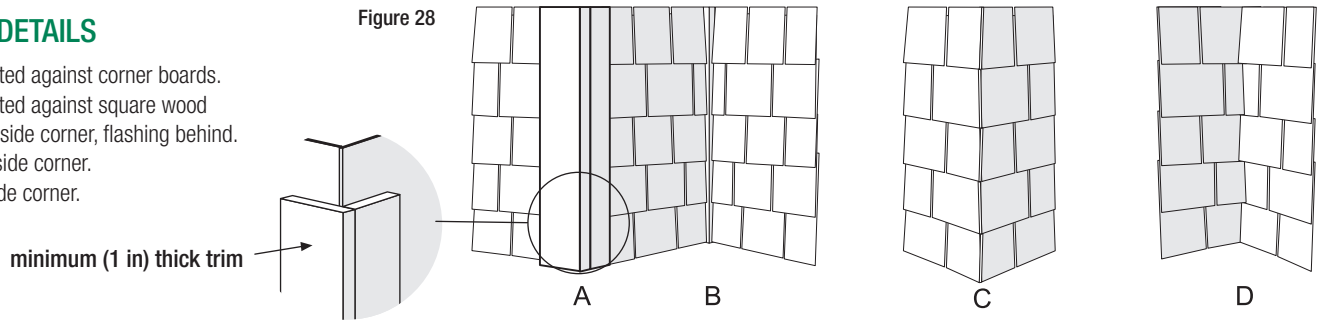

WINDOWS AND DOORS

Building wall components such as windows, doors and other exterior wall penetrations shall be installed in accordance with the component manufacturer's written installation instructions and local building codes. Where windows or doors are installed, continue the application of siding as if the wall is complete. Trimming for the opening and using the resulting piece may throw off the spacing above the break.

GENERAL FASTENING REQUIREMENTS

Fasteners must be corrosion resistant, galvanized, or stainless steel. Electro-galvanized are acceptable but may exhibit premature corrosion. James Hardie recommends the use of quality, hot-dipped galvanized nails. James Hardie is not responsible for the corrosion resistance of fasteners. Stainless steel fasteners are recommended when installing James Hardie® products near the ocean, large bodies of water, or in very humid climates.

Manufacturers of ACQ and CA preservative-treated wood recommend spacer materials or other physical barriers to prevent direct contact of ACQ or CA preservative-treated wood and aluminum products. Fasteners used to attach HardieTrim Tabs to preservative-treated wood shall be of hot dipped zinc-coated galvanized steel or stainless steel and in accordance to 2009 IRC R317.3 or 2009 IBC 2304.9.5

- Consult applicable product evaluation or listing for correct fasteners type and placement to achieve specified design wind loads.
- NOTE: Published wind loads may not be applicable to all areas where Local Building Codes have specific jurisdiction. Consult James Hardie Technical Services if you are unsure of applicable compliance documentation.
- Drive fasteners perpendicular to siding and framing.
- Fastener heads should fit snug against siding (no air space).
- NOTE: Whenever a structural member is present, HardiePlank should be fastened with even spacing to the structural member. The tables allowing direct to OSB or plywood should only be used when traditional framing is not available.

PNEUMATIC FASTENING

James Hardie products can be hand nailed or fastened with a pneumatic tool. Pneumatic fastening is highly recommended. Set air pressure so that the fastener is driven snug with the surface of the siding. A flush mount attachment on the pneumatic tool is recommended. This will help control the depth the nail is driven. If setting the nail depth proves difficult, choose a setting that under drives the nail. (Drive under driven nails snug with a smooth faced hammer - Does not apply for installation to steel framing).

 SNUG	 FLUSH	<p>DO NOT</p> UNDER DRIVE	<p>DO NOT</p> OVER DRIVE	 SLANT	<p>DO NOT USE</p> ALUMINUM FASTENERS
<p>IF, THEN</p> <p>WOOD FRAME</p> HAMMER FLUSH		<p>IF, THEN ADDITIONAL NAIL</p> <p>STEEL FRAME</p> FACE NAIL COUNTERSINK & FILL	<p>DO NOT USE</p> CLIPPED HEAD NAILS		
		<p>DO NOT USE</p> STAPLES			



CUT EDGE TREATMENT

Caulk, paint or prime all field cut edges. James Hardie touch-up kits are required to touch-up ColorPlus products.

CAULKING

For best results use an Elastomeric Joint Sealant complying with ASTM C920 Grade NS, Class 25 or higher or a Latex Joint Sealant complying with ASTM C834. Caulking/Sealant must be applied in accordance with the caulking/sealant manufacturer's written instructions.

Note: some caulking manufacturers do not allow "tooling".

COLORPLUS® TECHNOLOGY CAULKING, TOUCH-UP & LAMINATE

- Care should be taken when handling and cutting James Hardie® ColorPlus® products. During installation use a wet soft cloth or soft brush to gently wipe off any residue or construction dust left on the product, then rinse with a garden hose.
- Touch up nicks, scrapes and nail heads using the ColorPlus® Technology touch-up applicator. Touch-up should be used sparingly. If large areas require touch-up, replace the damaged area with new HardiePlank® lap siding with ColorPlus® Technology.
- Laminate sheet must be removed immediately after installation of each course.
- Terminate non-factory cut edges into trim where possible, and caulk. Color matched caulks are available from your ColorPlus® product dealer.
- Treat all other non-factory cut edges using the ColorPlus Technology edge coat, available from your ColorPlus product dealer.

Note: James Hardie does not warrant the usage of third party touch-up or paints used as touch-up on James Hardie ColorPlus products.

Problems with appearance or performance arising from use of third party touch-up paints or paints used as touch-up that are not James Hardie touch-up will not be covered under the James Hardie ColorPlus Limited Finish Warranty.

PAINTING JAMES HARDIE® SIDING AND TRIM PRODUCTS WITH COLORPLUS® TECHNOLOGY

When repainting ColorPlus products, James Hardie recommends the following regarding surface preparation and topcoat application:

- Ensure the surface is clean, dry, and free of any dust, dirt, or mildew
- Repriming is normally not necessary
- 100% acrylic topcoats are recommended
- DO NOT use stain, oil/alkyd base paint, or powder coating on James Hardie® Products.
- Apply finish coat in accordance with paint manufacturers written instructions regarding coverage, application methods, and application temperature
- DO NOT caulk nail heads when using ColorPlus products, refer to the ColorPlus touch-up section

5 IN EXPOSURE HARDIESHINGLE® STRAIGHT EDGE PANELS INSTALLATION (For 7 in exposure product please go to page 4)

Maximum Exposure of 5 in

REFER TO STAGGERED EDGE INSTRUCTIONS ON PAGE 3

Steps 1 - 4

Figure 29

Steps 5 & 6

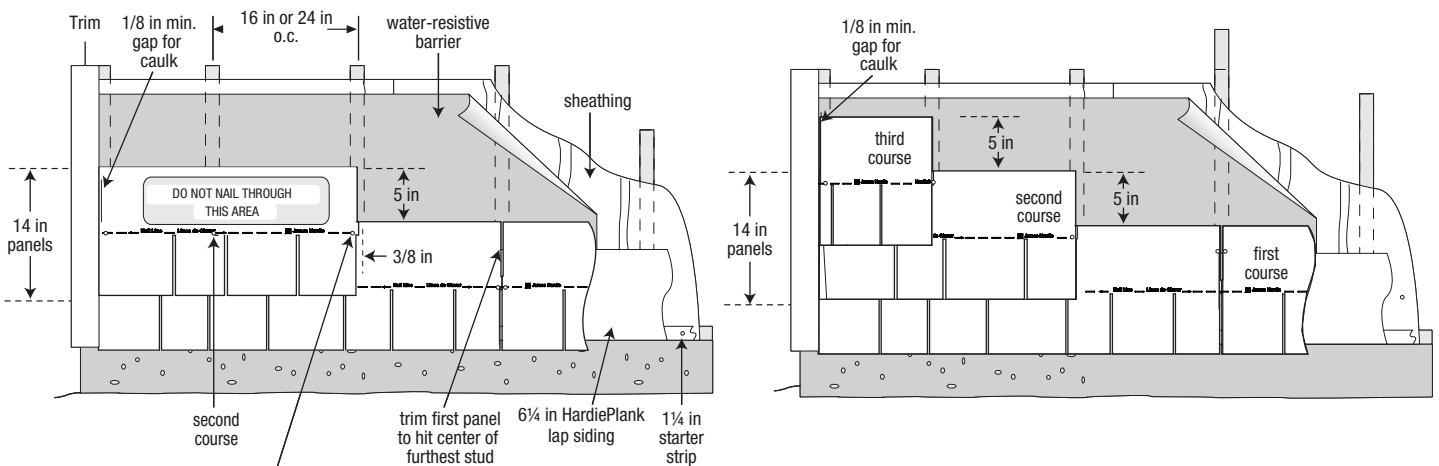

position nails on nail line and secure into framing. Only when application is to minimum 7/16 in thick APA rated sheathing, position nails on nail line spaced a maximum of 13 3/4 in o.c. Allow 3/8 in from panel edges.

HARDIESHINGLE® STRAIGHT EDGE PANEL COVERAGE

Panels for sidewall applications are available in 48 in lengths. Pieces needed for one square (100sq.ft.) of product coverage = approximately 60, based on maximum 5 in exposure.



HARDIESHINGLE® INDIVIDUAL SHINGLE INSTALLATION

HardieShingle Individual Shingles must be installed with the widest part of the shingle placed downwards and directly to minimum 7/16 in thick sheathing.

Fastener Requirements

0.091 in x 0.221 in HD x 1 1/2 in or 0.121 in x 0.371 in HD x 1 1/4 in long corrosion resistant siding nails are used for fixing HardieShingle siding to 7/16 in thick APA rated sheathing.

HardieShingle Individual Shingle Installation

Due to overlapping of the joints, caulk is not required except where panels butt trim boards. Space shingles a maximum 1/4 in apart and leave a min. lap of 1 1/2 in between successive courses (fig. 31).

- 1) Install 1 1/4 in starter strip and a 6 1/4 in wide HardiePlank siding starter course.
- 2) Install first shingle from the end abutting trim. Install widest part of shingle placed downwards. (fig. 30).
- 3) Secure shingle, leaving a 1/8 in gap for caulk at trim and continue the course along the wall.
- 4) Start the second course, leaving a minimum lap of 1 1/2 in between successive courses, again from the end abutting the trim. Repeat step 3.
- 5) Continue up the wall repeating steps 2 through 5 until desired height is reached.

Figure 30

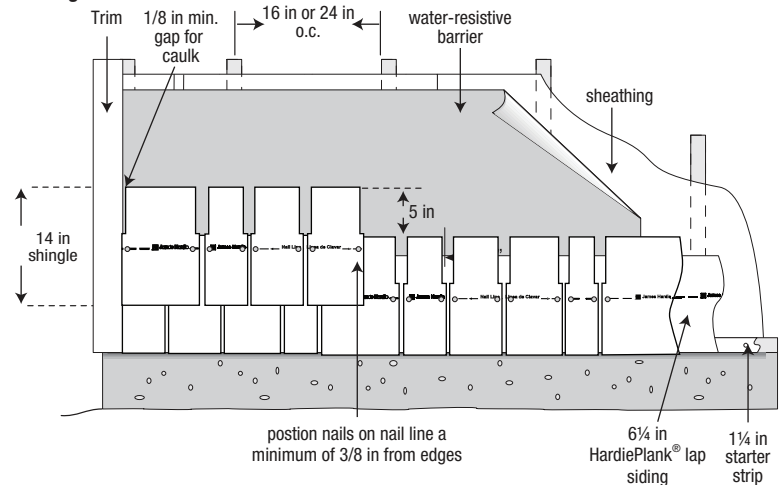

5 IN EXPOSURE HARDIESHINGLE® INDIVIDUAL SHINGLE COVERAGE

Individual Shingles for sidewall applications are available in assorted widths as listed below. Bundles needed for one square (100 sq. ft.) of product coverage:

Shingle Width	Number of Bundles	Pieces per Bundle
3-1/2 in	3	20
4-1/2 in	6	20
5-1/2 in	6	20
7 in	6	20
8-3/4 in	3	20

Figure 31

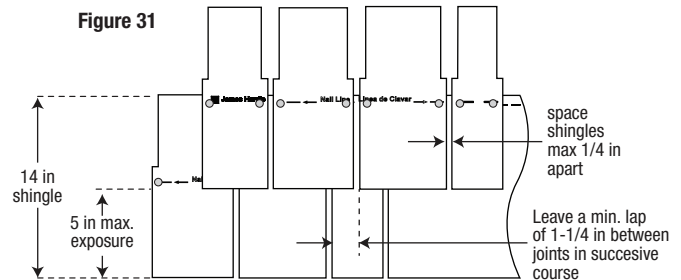

! Install with the widest part of the shingle placed downwards

HS1067 P/8/ 04/18

SILICA WARNING

DANGER: May cause cancer if dust from product is inhaled. Causes damage to lungs and respiratory system through prolonged or repeated inhalation of dust from product. Refer to the current product Safety Data Sheet before use. The hazard associated with fiber cement arises from crystalline silica present in the dust generated by activities such as cutting, machining, drilling, routing, sawing, crushing, or otherwise abrading fiber cement, and when cleaning up, disposing of or moving the dust. When doing any of these activities in a manner that generates dust you must (1) comply with the OSHA standard for silica dust and/or other applicable law, (2) follow James Hardie cutting instructions to reduce or limit the release of dust; (3) warn others in the area to avoid breathing the dust; (4) when using mechanical saw or high speed cutting tools, work outdoors and use dust collection equipment; and (5) if no other dust controls are available, wear a dust mask or respirator that meets NIOSH requirements (e.g. N-95 dust mask). During clean-up, use a well maintained vacuum and filter appropriate for capturing fine (respirable) dust or use wet clean-up methods - never dry sweep.

! **WARNING:** This product can expose you to chemicals including respirable crystalline silica, which is known to the State of California to cause cancer. For more information go to P65Warnings.ca.gov.

RECOGNITION: In accordance with ICC-ES Evaluation Report ESR-2290, HardiePlank® lap siding is recognized as a suitable alternate to that specified in: the 2006, 2009, & 2012 International Residential Code for One- and Two-Family Dwellings, and the 2006, 2009, & 2012 International Building Code. HardiePlank lap siding is also recognized for application in the following: City of Los Angeles Research Report No. 24862, State of Florida listing FL#889, Dade County, Florida NOA No. 02-0729.02, U.S. Dept. of HUD Materials Release 1263c, Texas Department of Insurance Product Evaluation EC-23, City of New York MEA 223-93-M, and California DSA PA-019. These documents should also be consulted for additional information concerning the suitability of this product for specific applications.