



Thank you for selecting JELD-WEN products. Attached are JELD-WEN's recommended installation instructions for vinyl windows without a nailing fin (including finless, flush fin and flange). **Read these instructions thoroughly before beginning. They are designed to work in most existing applications, however, existing conditions may require changes to these instructions. If changes are needed, they are made at the installer's risk, however, approved methods will not typically affect warranty coverage. See the appropriate warranty for details. For installations other than indicated in these instructions, contact a building professional.**

Newer construction methods have led to an increase in air and water tightness in buildings. This frequently leads to negative air pressure inside the house, which can draw water through very small openings. Our installation method creates an air seal on the interior, integrating the window with the rough opening.

### IMPORTANT INFORMATION AND GLOSSARY

Not all window types may be installed into every wall condition in all areas. Consult your local building code official for applicable building codes and regulations. Local building code requirements supersede recommended installation instructions. Areas such as Florida and the Texas TDI region have different anchoring requirements based on product certification. For information on specific products, visit [www.floridabuilding.org](http://www.floridabuilding.org) or [www.tdi.texas.gov](http://www.tdi.texas.gov) and follow the anchoring schedule given in the drawings for the product instead of the anchoring schedule in this document.

**Note!** Installations where the sill is higher than 35 feet above ground level, or any product installation into a wall condition not specifically addressed in these instructions, must be designed by an architect or structural engineer. Failure to install windows into square, level, and plumb openings could result in denial of warranty claims for operational or performance problems.

**Note to Installer:** Provide a copy of these instructions to the building owner. By installing this product, you acknowledge the terms and conditions of the limited warranty as part of the terms of the sale.

#### GLOSSARY

##### Backer Rod (backing material)

A material (e.g. foam rod), placed into a joint primarily to control the depth of the sealant.

##### Buck

A wood framework attached to the masonry inside a window or patio door rough opening.

##### Finless Window

A window without a nailing fin commonly referred to as finless, replacement, block frame, box frame, or pocket.

##### Flush Fin Window

A window without a nailing fin that has a face flange (trim only). Flush fin windows may also be known as flange, stucco flange or Florida flange windows.

##### Head Expander

A vinyl accessory used to cover the head of the window in some retrofit applications.

##### Installation Clip

A vinyl accessory that snaps into the accessory groove of some fixed windows, used to secure the window to the rough opening.

##### Precast Sill

A pre-formed concrete block placed in a masonry/block wall to support a window.

##### Shiplap

The layering method in which each layer overlaps the layer below it so that water runs down the outside.

##### Sill Adapter

A replacement frame component attached to the sill of a finless window being installed into an existing window frame with a sloped sill. The component cancels out the sloped sill of the existing double-hung, helping to support the front edge of the window sill.

##### Stop

The trim pieces on the frame that retain the sashes.

##### Weep Hole (weep channel)

The visible exit or entry part of a water drainage system used to direct and drain water out of a window.

Estimated Install Time for New Construction	<input type="checkbox"/> First Time: 2 hrs
	<input type="checkbox"/> Experienced: 1.5 hrs
	<input type="checkbox"/> Professional: 1 hr



### ROUGH OPENINGS

#### THESE INSTRUCTIONS SPECIFICALLY ADDRESS:

**Note!** For installation conditions other than indicated in these instructions, contact a building professional.

- Installation of a flush fin window into an existing aluminum window frame or masonry wall. It is assumed there is a minimum 3/8" wide flat surface for the flush fin to seal against. This flat surface should be flush with or protrude past the exterior wall surface. This is intended to be a secondary weather barrier with the interior air seal the primary barrier.
- Installation of a finless window into an existing wood or aluminum window frame.
- Installation of a finless window into a masonry or stud framed wall.

#### INSTALLATION INTO AN EXISTING WINDOW FRAME

A finless window used as a replacement product installed into an existing wood or aluminum window frame after the old sash(es) and hardware have been removed. The existing window frame must be watertight within the structure. Correct pre-existing water leaks before installation. Any damaged portions of the existing sloped sill must be repaired and sealed to be waterproof.

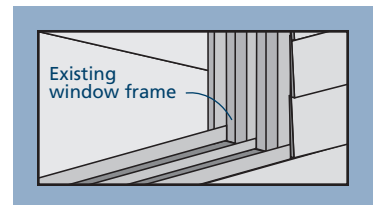

Flush fin windows must be installed onto a surface with at least a 3/8" wide exterior face. This face must be flush with or protrude past the exterior wall surface.

**ROUGH OPENINGS - CONTINUED**

**MASONRY/BLOCK WALL CONSTRUCTION**

This installation assumes that a building professional has already properly fastened and sealed a framework of studs (often called a buck) to the concrete/masonry wall. If using a precast sill, the buck will be installed only on the head and jambs.

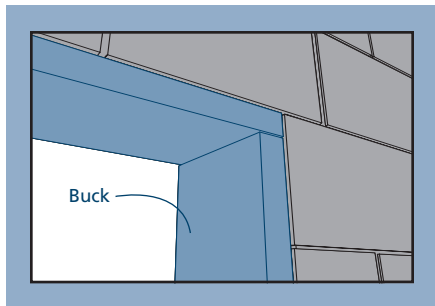

**FULLY SHEATHED STUD-FRAMED WALL CONSTRUCTION**

The wall is covered by sheathing and the window will be mounted inside of the rough opening. This installation assumes building wrap is properly installed prior to installation.

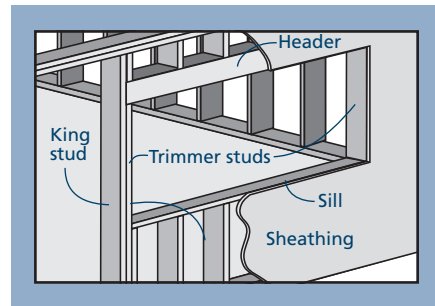

**OPEN STUD WALL CONSTRUCTION**

The window will be mounted inside of the rough opening. This installation assumes building wrap is properly installed prior to installation.

**SAFETY AND HANDLING**

**SAFETY**

- Read and fully understand ALL manufacturers' instructions before beginning. Failure to follow proper installation instructions may result in the denial of warranty claims for operational or performance problems.
- Do not work alone. Two or more people are required. Use safe lifting techniques.
- Use caution when handling glass. Broken or cracked glass can cause serious injury.
- Wear protective gear (e.g. safety glasses, gloves, ear protection, etc.).
- Operate hand/power tools safely and follow manufacturer's operating instructions.
- Use caution when working at elevated heights.
- If disturbing existing paint, take proper precautions if lead paint is suspected (commonly used before 1979). Your regional EPA ([www.epa.gov/lead](http://www.epa.gov/lead)) or Consumer Product Safety Commission offices provide information regarding regulations and lead protection.

**MATERIALS AND WINDOW HANDLING**

- Make sure operable windows are locked prior to installation.
- Heed material manufacturers' handling and application instructions.
- Protect adhesive surfaces from dirt, moisture, direct sunlight and folding over onto themselves.
- Handle in vertical position; do not carry flat or drag on floor.
- Do not put stress on joints, corners or frames.
- Store window in dry, well-ventilated area in vertical, leaning position to allow air circulation; do not stack horizontally.
- Protect from exposure to direct sunlight during storage.
- Install only into vertical walls and when conditions and sheathing are dry.

**IF INJURY OCCURS, IMMEDIATELY SEEK MEDICAL ATTENTION!**

**MATERIALS AND TOOLS**

**PROVIDED MATERIALS (INCLUDED WHEN ORDERED)**

- Double Hung windows have two jamb adjuster screws.
- Dust plugs to cover installation screws.
- Jamb installation clips only provided for Fixed, Stationary Awning/Casement windows.

**NEEDED MATERIALS**

**Note! Follow all material manufacturers' instructions for proper use and compatibility. When using flashing, spray adhesive/primer, sealant and foam products, we recommend using the same manufacturer and verifying compatibility. It is the End User's responsibility to determine if dissimilar materials are compatible to the substrates in the application.**

- #8 x 1 1/4" corrosion-resistant pan head screws. Screws must penetrate at least 1" into framing (or as required by local code).
- For securing the sill in masonry applications, 3/16" x 1 1/4" minimum self-tapping concrete screws (gasketed head optional) (or as required by local code).
- Sealant: For sill fasteners and if left exposed use 100% silicone. If painted we recommend OSI® QUAD® Max Sealant or equivalent. This can be used in any application and can be painted or ordered in a color matched product, if desired.
- Backer rod 1/8" larger than the widest portion of the gap (used in conjunction with sealant bead).
- Non-Compressible or non-water degradable shims.
- Polyurethane low expansion Window and Door foam: We recommend OSI® QUAD® Foam or equivalent).

- 4", 6", or 9" (as required by local code and window configuration) wide self-adhesive flashing: We recommend OSI® Butyl Flash or equivalent.

**Additional Materials Needed if Installing into an Existing Window Frame**

- Composite or solid wood (cedar or redwood recommended) or exterior grade plywood for continuous support.
- If installing into an aluminum window, dimensions should be 1/2" shorter than the length of the sill track and 1/4" taller than the depth of the track.
- If installing into a wood window, dimensions should be 1/4" thick, length of the existing frame sill minus 1" and the width of the new vinyl window side jamb minus 1/4".

**Additional Materials Needed if Installing into a Masonry Wall**

- Liquid applied flashing (Protecto Wrap LWM 200 or equivalent)
- Composite or solid wood (cedar or redwood recommended) or exterior grade plywood for continuous support.

**NEEDED TOOLS**

- Tape measure
- Utility knife
- Level (4' minimum recommended)
- J-roller
- Screwdriver
- Hacksaw
- Putty knife
- Caulking gun
- Drill with bits
- Hammer

# 1 REMOVE PACKAGING AND INSPECT WINDOW

## REMOVE PACKAGING

Remove shipping materials such as corner covers, shipping blocks or pads. If there is a protective film on the glass, do not remove it until installation and construction are complete.

## INSPECT WINDOW

- Cosmetic damage.
- Product squareness (diagonal measurements not more than 1/8" different).

- Correct product (size, color, grid pattern, glass type, energy-efficiency requirements, etc.).
- Cracked frame welds or other frame damage.

If any of the above conditions represent a concern, or if you expect environmental conditions to exceed the window's performance rating, do not install the window. Contact your dealer or distributor for recommendations.

# 2 INSPECT ROUGH OPENING

- Verify the width and height of the window are each 1/2" smaller than the rough opening width and height.
- Verify the rough opening is square. The (A) and (B) measurements above should be the same. Maximum allowable deviation from square for windows over 20 sq. ft. is 1/4" and for windows under 20 sq. ft. is 1/8".

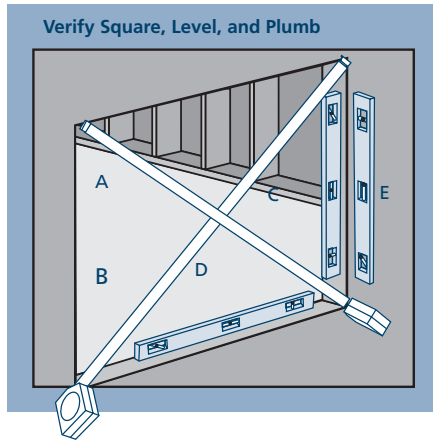

- Verify the rough opening is level and plumb (C) and (D). The maximum allowable deviation is 1/8".
- The rough opening sill must not be crowned or sagged (D), but rather level or sloped (positive slope) to the exterior.
- Verify the exterior face of the rough opening is a single plane (E) with less than 1/8" twist from corner to corner.
- Verify the rough opening is structurally sound.
- Correct any deviations before installing the window.

# 3 PREPARE WINDOW OPENING

## PREPARE EXISTING WINDOW FRAME

1. Remove the sashes and/or glass in the existing window.
2. Remove all hardware and window components not a part of the frame (meeting stile, jamb liners, locking mechanisms or other hardware etc.).

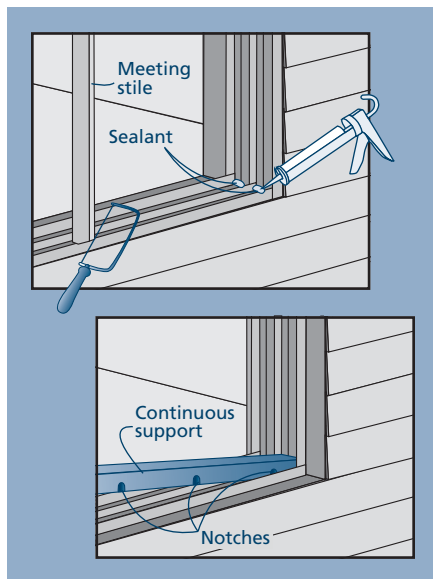

## IF INSTALLING INTO AN ALUMINUM WINDOW FRAME:

1. Seal all four corners of the window frame as shown.
2. Notch grooves across the bottom of the continuous support (see materials list) to allow for water drainage through the weep holes. Set the continuous support into the exterior sill track, creating a level surface at the sill.

**END of Aluminum Frame Instructions, SKIP to section 4, "INSTALL WINDOW."**

## IF INSTALLING INTO A WOOD WINDOW FRAME:

- 1a. If installing from the interior, remove any trim on the inside face of the wood frame. Do not remove the exterior stops.
- 1b. If installing from the exterior, remove any trim on the outside face of the wood frame. Do not remove the interior stops.

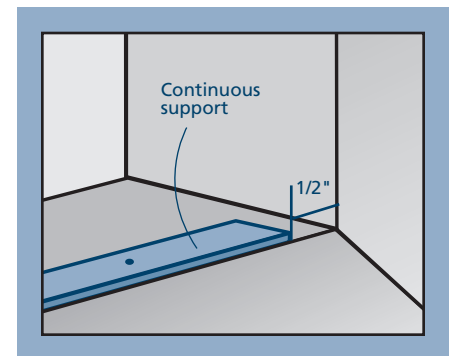

- Note! Steps 2 and 3 are not applicable if installing into an existing double-hung with sloped sill.**
2. Apply enough sealant to the bottom of the continuous support to cover the entire surface.
  3. Center the continuous support (see materials list) on the sill of the existing frame, flush to the exterior edge and leaving a 1/2" gap at the ends. Secure with nails.

**END of Existing Window Frame Instructions, SKIP to section 4, "INSTALL WINDOW."**

**3 PREPARE WINDOW OPENING - CONTINUED**

**PREPARE MASONRY OPENING WITH BUCK**

1. Seal any joint larger than 1/16" in the buck and between the buck and the concrete/masonry with sealant.
2. Cover the buck and the surrounding concrete/masonry at the head and jambs with liquid applied flashing as shown.
3. If installing into a four-sided buck, seal the sill in a similar manner.

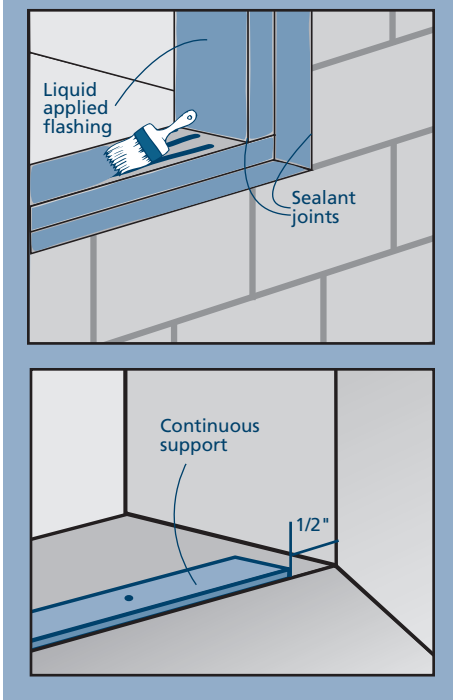

**Note!** Where the window will sit on the sill, shim to provide continuous support to the sill. This shimming must be 1/2" shorter than the width of the window frame, be 1/4" narrower than the depth of the window frame sill, should level the rough opening sill and be no more than 1/4" thick.

4. Center the continuous support on the sill of the opening, flush to the exterior edge and leaving a 1/2" gap at the ends. Secure in place.

**END of Buck Instructions, SKIP to section 4, "INSTALL WINDOW."**

**PREPARE STUD-FRAMED WALL**

**PREPARE BUILDING WRAP**

Trim building wrap flush with the edges of the rough opening (or follow manufacturers' instructions for trimming).

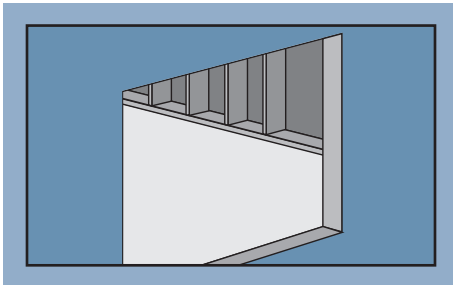

**PREPARE/SHIM THE SILL**

1. Use self adhesive flashing to waterproof the sill.
2. Flashing must have at least 1" of material wrapped below the sill onto the vertical wall. Flashing width must be at least frame width + 1".
3. Measure the width of the frame and subtract 1/4". Transfer this measurement from the outside edge of the rough opening sill and draw a line all along the rough opening sill. This is where the back of the flashing will sit.
4. Cut a piece of flashing the length of the sill plus 12".
5. Place flashing on rough opening sill, wrapping the flashing up 6" on each jamb as shown.
6. Pull release tape and set flashing into place.
7. Fold the flashing down onto the sheathing. Staple flashing to the wall, if needed, and seal the corner edges as shown.
8. Smooth out any bubbles or creases with a J-roller.
9. Install the continuous support as follows:

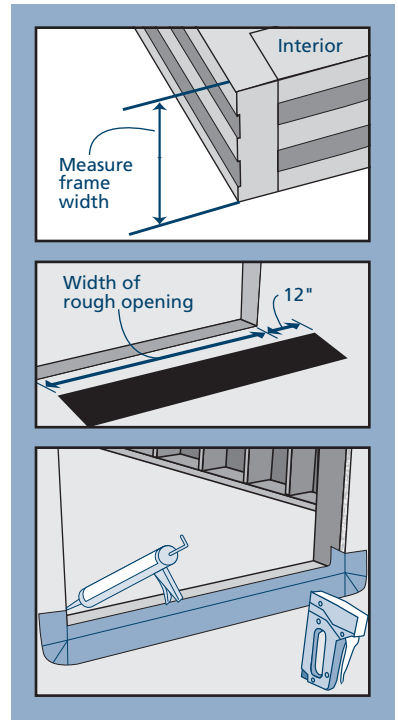

**Note!** Where the window will sit on the sill, shim to provide continuous support to the sill. This shimming must be 1/2" shorter than the width of the window frame, be 1/4" narrower than the depth of the window frame sill, should level the rough opening sill and be no more than 1/4" thick.

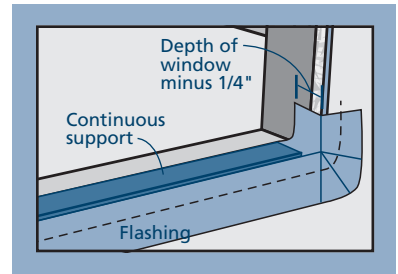

10. Align the shimming on the sill flush with the exterior and centered between the side jambs. If installing a mullied unit, leave gaps at the mull joint(s) so they don't sit on the shimming and tack into place or secure with sealant.

**4** INSTALL WINDOW

**Warning!** To avoid injury, use at least two people to install. Adequately support the window until fully installed.

**Note!** Areas such as Florida and the Texas TDI region have different anchoring requirements based on product certification. For information on specific products, visit [www.floridabuilding.org](http://www.floridabuilding.org) or [www.tdi.texas.gov](http://www.tdi.texas.gov) and follow the anchoring schedule given in the drawings for the product instead of the anchoring schedule in this document.

**FRAME PREPARATION**

- If the window has open tracks (most sliding and hung windows), remove track fillers if present. If installing a sliding window, remove the operating sash and the track for access to the sill pocket. Mark fastener locations within the frame track using the spacing given below in "Fastener Locations", or as required by local code.

- If the window does not have open tracks (awning, casement and fixed without open tracks), these windows can be fastened one of three ways:

1. Use installation clips (excludes windows with pre-applied extension jamb; provided or available through dealers). Snap a clip into the interior accessory groove according to the spacing given below in "Fastener Locations."
2. Through the frame (screws can be covered with dust plugs, provided or available through dealers) using the pattern in "Fastener Locations."
3. Stopped in place (excludes windows with pre-applied extension jamb) with trim or drywall (excludes impact). No fasteners are required through the frame.

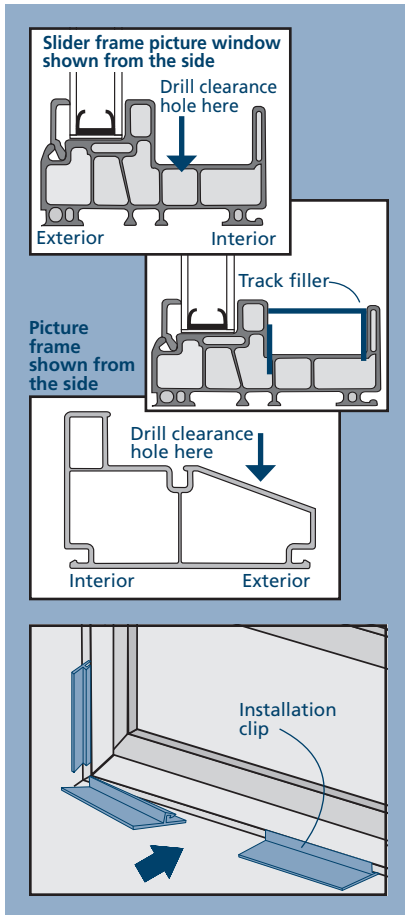

**FASTENER LOCATIONS**

Products are fastened according to performance rating (some holes may be pre-drilled). Performance rating is located on the purchase paperwork or gold AAMA label fixed somewhere on the frame, generally in the head jamb. Look for something like this example: R-PG20-122X76 (48X30)-HS. If this label is missing, use the PG50 and above fastener pattern.

PG20--3" – 6" from the corners and every 24" on center.

PG35--3" – 6" from each corner and every 18" on center.

PG50 and above--3" – 6" from each corner and every 12" on center.

<b>Mull Joints</b>	The first 8" beyond mull joints, on both sides, must be fastened through each nail fin hole.
<b>Continuous Head and Sill above PG35</b>	The first 4" from center, on both sides, must be fastened every 2"

**DRILL CLEARANCE HOLES**

At each fastener location, drill a 3/8" clearance hole through ONLY the first wall of the frame to allow the screw head to pass through. Do not drill through the outer wall of the window frame.

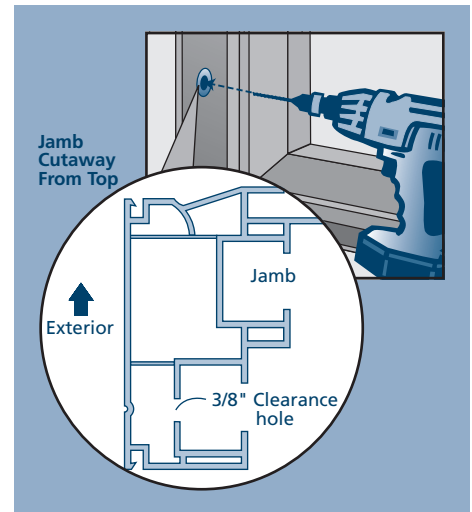

**IF INSTALLING A FLUSH FIN WINDOW**

1. If using an applied fin, apply a continuous bead of sealant on the interior around the window where the fin meets the frame.
2. Apply a 3/8" bead of sealant to the exterior face of the opening, leaving gaps at any weep holes if installing into an existing frame.
3. Place window in the opening, making sure the window rests on the shimming support and makes positive contact with the sealant.

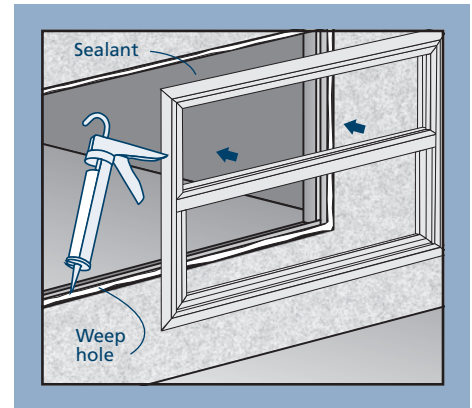

Continue with "All INSTALLATIONS."

**IF INSTALLING A FINLESS WINDOW**

If installing into an Existing Frame with a Sloped Sill:

1. If a detached sill adapter is used, cut to length, and snap into accessory groove at the sill.
2. Cut notches in the lower edge of the sill adapter to allow for water drainage; notches should be a minimum of 1/8" square and positioned under each weep hole of the window.
3. If the sill adapter covers weep holes, notch for proper drainage.

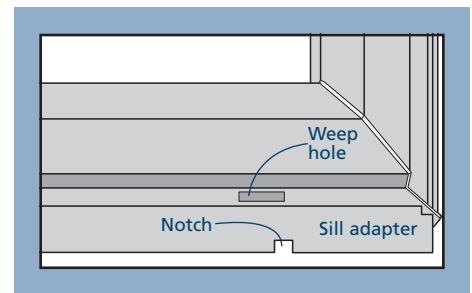

**4** INSTALL WINDOW - CONTINUED

4. Center the head expander (optional) over the head of the window as shown.

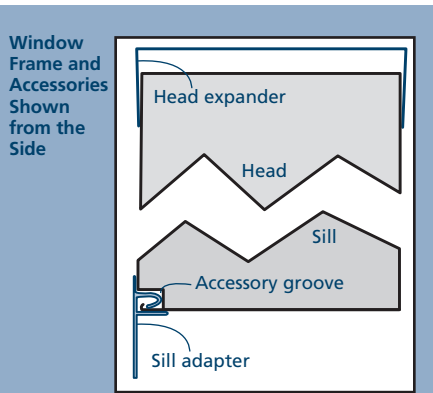

5. From the interior, apply sealant to the inside edge of the outside stop. Set window with a sill adapter fully against the outside stop. **Continue with "All Installations."**

**If installing into an Existing Frame or Rough Opening with a Flat Sill:** Center the head expander (optional) over the head of the window. Set new window into the existing window frame or rough opening. **Continue with "All Installations."**

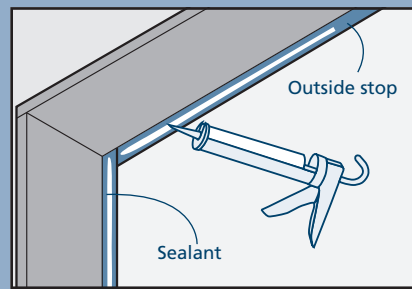

b. If installing a window with fasteners through the jambs, secure with a #8 screw until fully seated (without deforming vinyl).

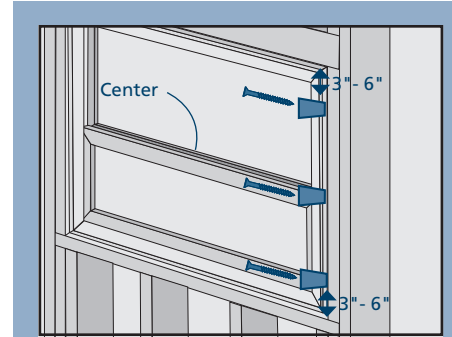

3. If installing a window using the stop in method, this installation assumes installation from the interior with exterior stops applied before window installation. All stops must overhang the window frame by a minimum of 1/8".

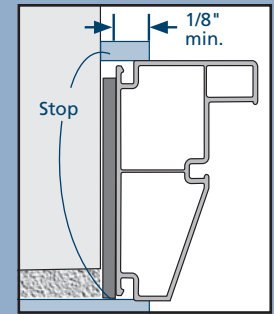

- Mill and install exterior stops in the desired location if necessary for the side and head jambs.
- Apply sealant to the interior side of the side and head jamb exterior stops and verify it is properly shimmed until square, level, and plumb.
- Apply backer rod and sealant or low expansion foam on the interior between the window frame and rough opening on all four sides.
- Install interior stops on all four sides.

**ALL INSTALLATIONS**

- Shim the side jambs between the rough opening or existing frame and the new window at each fastener location. Shims must be set 1/4" back from the interior of the window frame. Secure shims with sealant.
- Secure one upper corner as follows (skip to step 3 if using the stop in method):

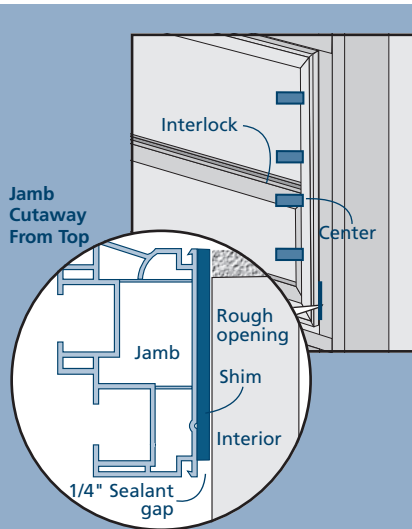

- If installing a window with installation clips, drive a screw through the clip until the screw head contacts the clip. Do not bend the clip toward the rough opening (applying a shim between clip and rough opening can be helpful to prevent bending the clip).

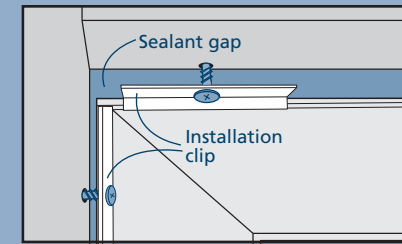

- Inspect window for square, level and plumb (adjust shims or remove and reinstall if necessary).
- Fasten window in a similar manner through the remaining corners, and then through the rest of the fastener locations. If installing fasteners in the sill, apply silicone sealant to the screw threads and the head of the screw in the window frame (use more sealant as necessary to completely seal the screw head to the frame), or use a gasketed head screw.
- Insert plugs into fastener holes not located in any operating track. Seal plugs in the sill with silicone. Replace track fillers if applicable.

- On some double hung operating units only, jamb adjuster hardware is mounted in the middle installation holes to allow for some jamb adjustment. Install jamb adjuster screws until captured (first 'click'), the screw may then be screwed in or out to adjust the jamb as needed. Replace lower sash.

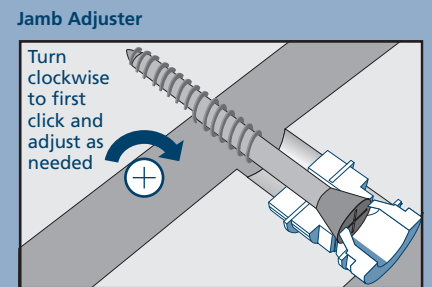

**5 COMPLETE INSTALLATION**

Create a continuous air seal on the interior by integrating the rough opening and the window frame with low expansion polyurethane foam or backer rod and sealant.

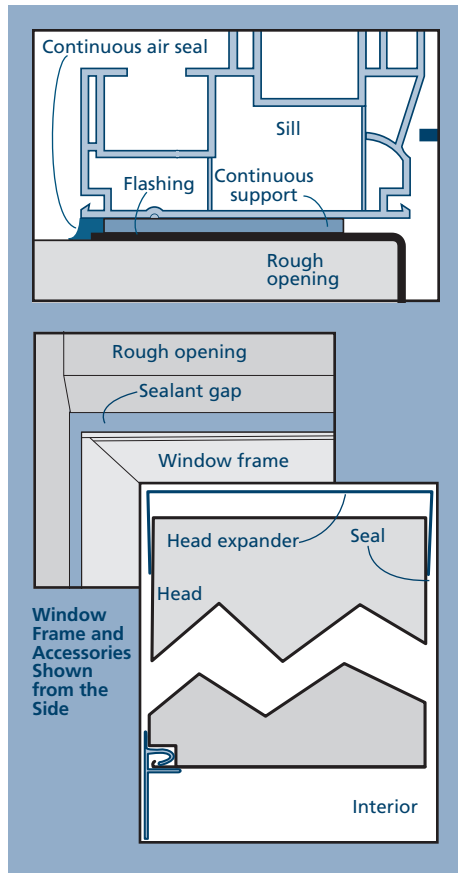

**FINISH INSTALLATION**

1. If installing a head expander, seal between the head expander and the window frame.
2. On the exterior, apply backer rod and sealant between the window frame and the rough opening.
3. If installing a sloped sill adapter, seal the joint between the existing sloped sill and sill adapter, leaving gaps at the weep holes.

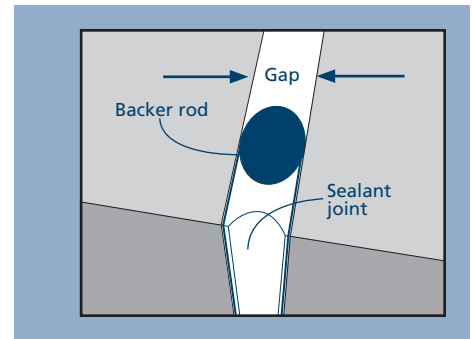

**AFTER INSTALLATION**

- Install exterior wall surface per manufactures' guidelines.
- Leave an expansion/contraction gap of approximately 3/8" between window frame and final exterior wall surface (siding, stucco, etc.). For a finished look and additional protection, seal this gap on the sides with backer rod and sealant. If sealant is applied above the drip cap ensure the sealant bead is discontinuous to allow for drainage.
- Ensure weep holes/channels are clear of debris for proper water drainage; do not seal weep holes/channels if present.
- If applicable, apply desired exterior vinyl trim.
- Protect recently installed units from damage from plaster, paint, etc. by covering the unit with plastic.

Please visit [jeld-wen.com](http://jeld-wen.com) for warranty and care and maintenance information.

Thank you for choosing

