



ITEM #0784791

LED MOTION-ACTIVATED BATTERY OPERATED SECURITY LIGHT

Utilitech & UT Design® and Grounded in Quality® are registered trademarks of LF, LLC. All Rights Reserved.

MODEL #SE1066-BP2-02LF0-U

Français p. 7

Español p. 13

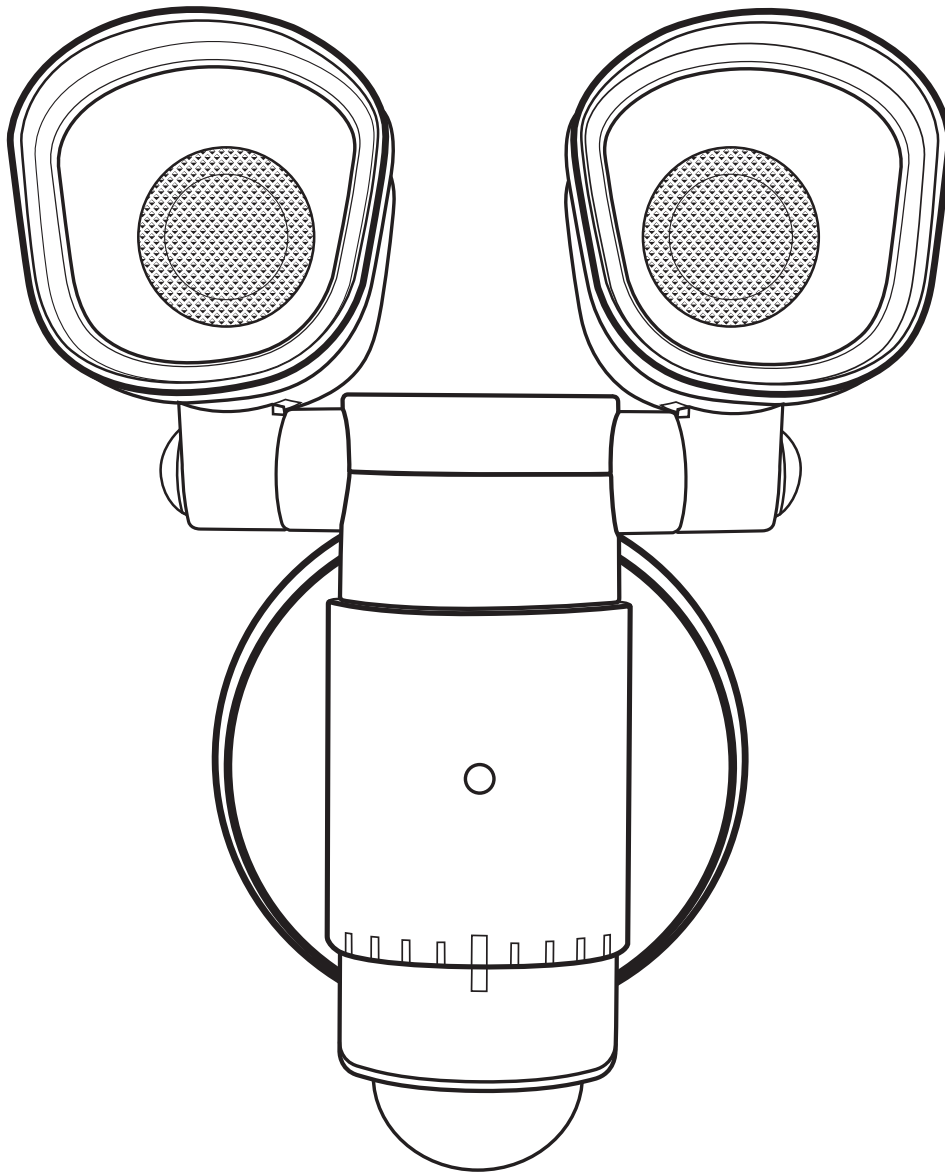

ATTACH YOUR RECEIPT HERE

Serial Number: _____ Purchase Date: _____



Questions, problems, missing parts? Contact the customer service department at 1-866-994-4148, 8 a.m. - 6 p.m., EST, Monday - Thursday, 8 a.m. - 5 p.m., EST, Friday.



PACKAGE CONTENTS

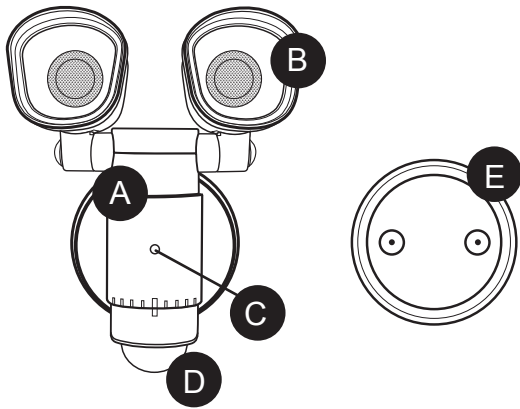

PART	DESCRIPTION	QUANTITY
A	Security Light	1
B	Light Head	2
C	Low Battery Indicator	1

PART	DESCRIPTION	QUANTITY
D	Motion Sensor	1
E	Mounting Base	1

HARDWARE CONTENTS (shown actual size)

AA

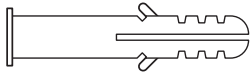

Anchors
Qty. 2

BB

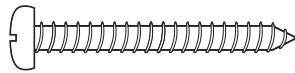

Wood Screws
Qty. 2

CC



Washers
Qty. 2

SAFETY INFORMATION

WARNING

- LEDs can be damaged by electrostatic discharge (ESD) shock. Before installation, discharge yourself by touching a grounded bare metal surface to remove this hazard. To avoid damage, do not remove the clear lens over the LED module.
- This device complies with Part 15 of the FCC rules. Operation is subject to the following two conditions: (1) This device may not cause harmful interference, and (2) this device must accept any interference received, including interference that may cause undesired operation.

PREPARATION

Before beginning assembly of product, make sure all parts are present. Compare parts with package contents list and hardware contents list. If any part is missing or damaged, do not attempt to assemble the product.

Estimated Assembly Time: 45 minutes

Tools Required for Assembly (not included):

Phillips Screwdriver, Safety Glasses, Drill, 3/16 in. Drill Bit, Step Ladder, and Soft Cloth

ASSEMBLY INSTRUCTIONS

1. Remove the mounting base (**E**) by turning counterclockwise until it comes loose. For mounting to concrete or masonry, install the anchors (**AA**) by drilling two 3/16-in. pilot holes into the mounting surface. Insert the anchors (**AA**) into the holes and tap them into place so they are flush with the surface. Place the mounting base (**E**), with the writing facing away from the wall, over the mounting location and secure the mounting base to the mounting surface with wood screws (**BB**).

Hardware Used

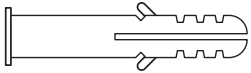
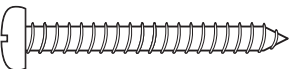
AA	Anchors		x 2
BB	Wood Screws		x 2

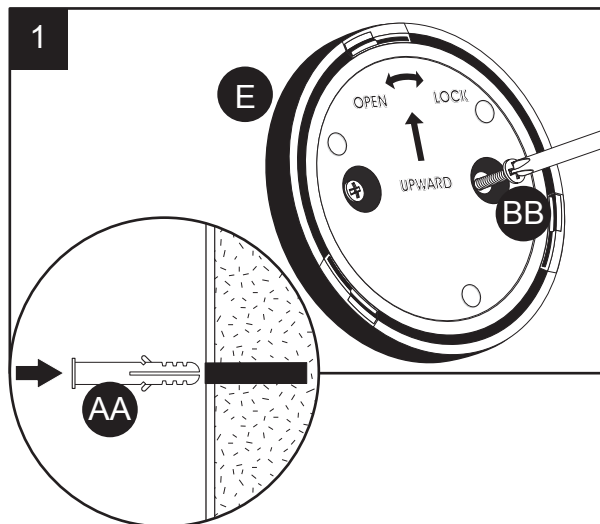

2. Remove the screw on the battery compartment cover. With your fingertip, pull up on the battery compartment catch and pull outward to remove the battery compartment cover.

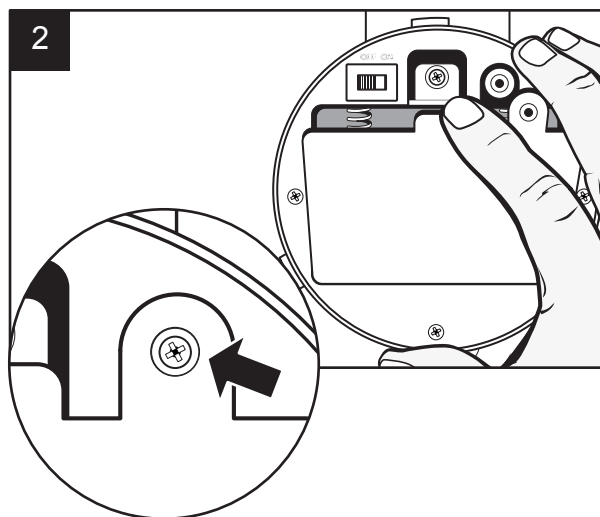

3. Insert 3 new alkaline C cell batteries (not included) into the battery compartment and orient them with the "+" and "-" markings on the back of the battery compartment. Re-attach the battery compartment cover by aligning the legs on the lower edge of the battery compartment cover onto the fixture body and close the cover until the catch at the top engages. Re-attach the screw. When ready to use, turn the switch, located above the battery compartment, to "ON". There will be an approximate 15 second delay for the fixture to light up, even if there is motion. This will occur every time the fixture is turned "OFF" and back "ON" at the switch or the batteries are changed. Do not mix old and new batteries. Cold weather may have a negative impact on battery life.

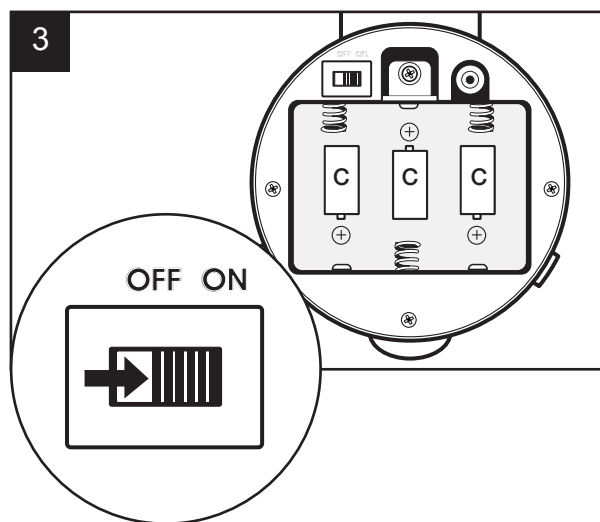

ASSEMBLY INSTRUCTIONS

4. Attach the security light (**A**) to the mounting base (**E**) by positioning the security light over the mounting base at an angle. Engage the security light into the grooves of the mounting base and secure by twisting clockwise until the security light is seated vertically.

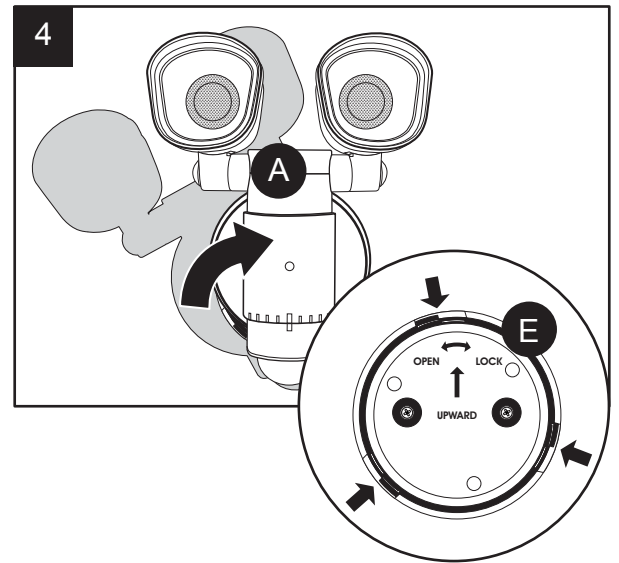

OPERATING INSTRUCTIONS

1. The individual light heads (**B**) can be adjusted side to side and up/down independently to aim the light heads in the direction desired.

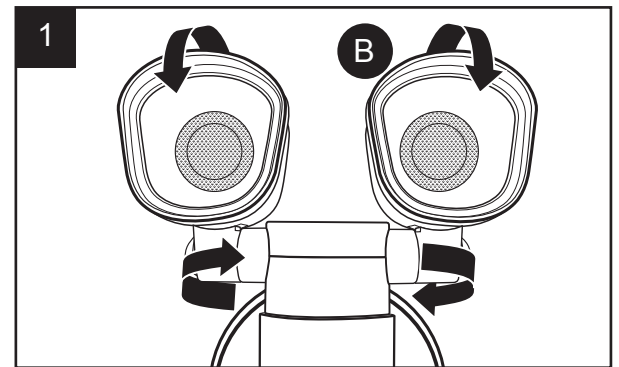

2. The motion sensor (**D**) can be rotated to position in the direction of an area to be covered. If the 2 tick marks are aligned, the motion sensor is focused straight ahead. The motion sensor can be rotated approximately 45° right or left of center. The motion sensor has a maximum detection field of 130° at a distance of 30 ft.

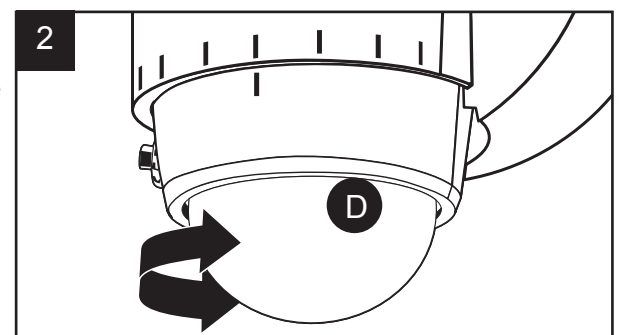

3. The control knobs for adjusting the operation of the security light (TIME, SENS and LUX) are located on the back side of the motion sensor (**D**). To gain access to these controls, rotate the sensor clockwise.

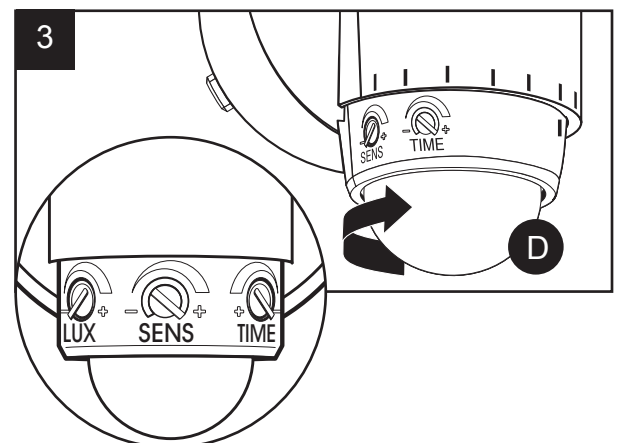

OPERATING INSTRUCTIONS

- The LUX control knob can be adjusted for the surrounding level of darkness needed to activate the sensor. This is quite variable. The far left position (-) sets for maximum level of darkness (or near full darkness). The far right position (+) sets for minimum level of darkness of darkness.



The SENS control knob can be adjusted to control the range of the sensor. The far left position (-) sets the sensor range to approximately 1 ft. The far right (+) sets the sensor range to approximately 30 ft.

The TIME control knob can be adjusted to control the length of time the light stays ON when triggered by the sensor. In the far left position (-), the duration time is approximately 10 seconds. In the far right position (+), the duration time is approximately 30 seconds.

BATTERY REPLACEMENT

- The red LED low battery indicator (**C**) on the front of the security light will light up when the batteries are low and need replacing. Alkaline batteries can last up to 300 days if the security light is activated for 10 seconds an average of 4 times per night.

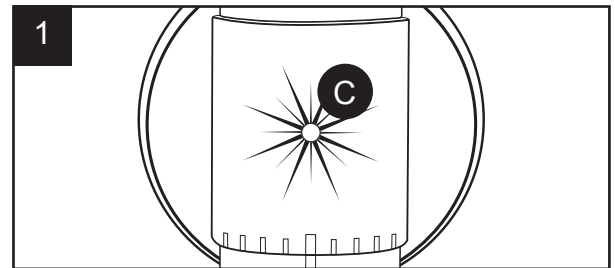

- Remove the security light (**A**) from the mounting base (**E**) by gripping the fixture and turning counterclockwise until the catches disengage from the mounting base.

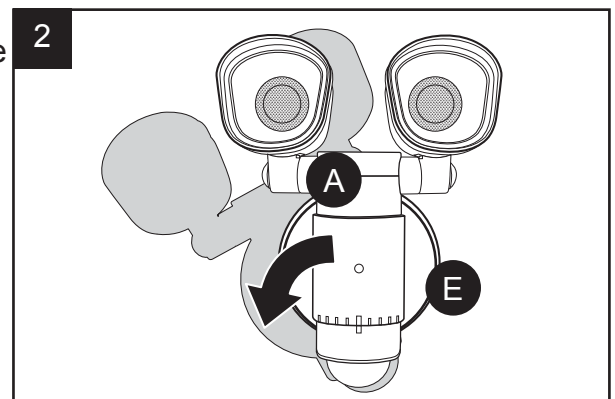

- Install new batteries into the fixture by following the instructions detailed in Steps 2 - 4 in the Assembly Instructions section.

CARE AND MAINTENANCE

Periodically clean the fixture using a mild, non-abrasive glass cleaner and soft cloth. Do NOT use solvents or cleaners containing abrasive agents. When cleaning the fixture, make sure the power is turned off. Do not spray liquid cleaner directly onto the LEDs, fixture, diffuser, or wiring.

This fixture uses LEDs (light emitting diodes) to provide light. LEDs do not burn out like traditional light bulbs and will last for 30 years or more (based on 3 hours of usage per day).

TROUBLESHOOTING

Extreme hot or cold weather could affect the performance of the built-in sensors that detect body heat. Certain winter clothing can shield a person's body heat from the sensor during extreme cold weather. During extreme hot weather, the sensor may not be able to distinguish the difference between normal body temperatures and the surrounding high temperatures. The sensor will begin working normally once weather conditions return to normal.

PROBLEM	POSSIBLE CAUSE	CORRECTIVE ACTION
Fixture doesn't light.	<ol style="list-style-type: none">1. ON/OFF switch is not set correctly.2. Batteries are defective.3. Batteries are installed wrong.4. Battery compartment cover is loose.	<ol style="list-style-type: none">1. Slide ON/OFF position.2. Replace the batteries.3. Install the batteries correctly.4. Check battery compartment cover.
Light flickers on and off.	<ol style="list-style-type: none">1. Photo sensor is picking up extraneous light.	<ol style="list-style-type: none">1. Remove batteries to reset photo sensor settings.
Fixtures stays on all night.	<ol style="list-style-type: none">1. Heat source/reflective body in detection area.	<ol style="list-style-type: none">1. Remove heat source/reflective body from detection zone or move fixture.
Motion sensor activates at random or for no reason.	<ol style="list-style-type: none">1. Momentary heat source or reflective body.2. Minor sensor problem.	<ol style="list-style-type: none">1. Turn sensor detection field away from source.2. Remove batteries to reset sensor.
Motion sensor does not activate at all.	<ol style="list-style-type: none">1. Batteries are depleted.2. ON/OFF switch is set to OFF.	<ol style="list-style-type: none">1. Check or replace batteries.2. Slide switch to ON position.
Detection range varies from day to day.	<ol style="list-style-type: none">1. Changes in meteorological conditions.	<ol style="list-style-type: none">1. Adjust the position of the sensor.

WARRANTY

The manufacturer warrants this lighting fixture to be free from defects in materials and workmanship for a period of (2) years from the date of original purchase by the consumer. The fixture is not warrantied for use in a commercial or retail application. The warranty is limited to use in a residential environment. We will repair or replace (at our option) the unit in the original color, and style if available, or in a similar color and style if the original item has been discontinued, without charge. Defective units must be properly packed and returned to the manufacturer with a letter of explanation and your original purchase receipt showing date of purchase. **Call 1-866-994-4148** to obtain a Return Authorization Number and an address where to ship your defective product. Note: C.O.D. shipments will NOT be accepted. The liability of the manufacturer is in any case limited to replacement of the defective light fixture product. The manufacturer will not be liable for any other loss, damage, labor costs or injury which is caused by the product. This limitation upon the liability of the manufacturer includes any loss, damage, or injury which is (I) to person or property or otherwise; (II) incidental or consequential in nature; (III) based upon theories of warranty, contract, negligence, strict liability, tort, or otherwise; or (IV) directly, or indirectly related to the sale, use, or repair of the product. This warranty gives you specific rights, and you may also have other rights which vary from state to state.

Printed in China

Utilitech® and UT Design® and Grounded in Quality® are registered trademarks of LF, LLC. All Rights Reserved.