

88171 Frameless Bottom Roll Sliding Door

Included in this package:

- 8 Long Screws
- 6 Short Screws
- 1 Top Track
- 1 Bottom Track
- 2 Sliding Mirror Doors
- 2 Mirror Pulls
- Bumper Pads

Tools Required

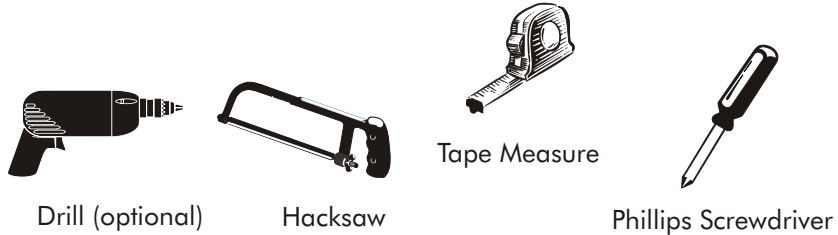

Step One

Trim Track to Fit Opening (if necessary)
Cut the Top "E" Channel and Bottom Track 1/16" (2mm) shorter than the opening width with a fine tooth hacksaw.

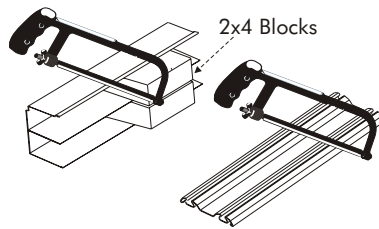

Step Two

Attach Top Track
Using the long screws, screw in "E" Channel to header, locating front edge 1/16" (2mm) back from jamb face as shown.

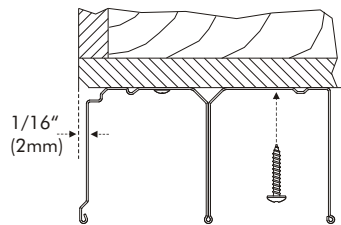

Step Three B

Attach Bottom Track (With Carpet):
Place 2" wide x length of bottom track x 1/8" thick (min) strip of plywood on top of carpet as shown.

Step Three A

Attach Bottom Track (Without Carpet):
Locate leading edge of floor track 7/8" (22mm) back from front face of jamb so doors hang plumb. Use the short screws for the bottom track.

Three A

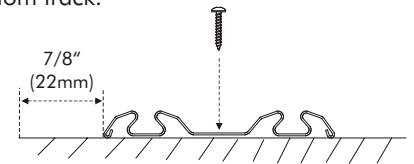

Three B

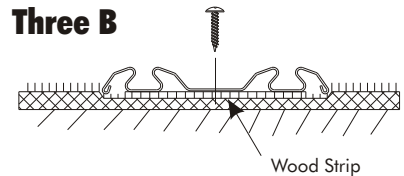

Step Four

Install Doors
To protect the bottom rail, extend the bottom rollers 1/2" (12mm) before installing (as shown in Step Five). Tilt the door at an angle, inserting the top of the door into the rear channel first. Snap the bottom rollers into the rear groove of the bottom track. Repeat for the front door.

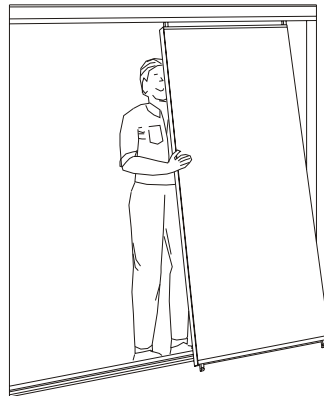

Step Five

Adjust Doors
For vertical adjustment and plumb doors, use a phillips screwdriver to adjust the bottom rollers as shown.

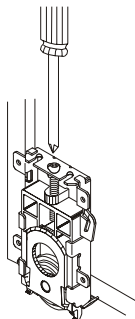

Step Six

Attach Mirror Pulls
Clean the mirror where the pull will be positioned, (approximately 40" (101 cm), 1/2" (1.3cm) in from the door's outside edge). Peel off the tape protection and press the pull firmly on the mirror. Once applied, the pull can not be re-positioned.

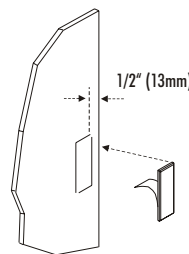

Cross Sectional Layout of Installed Doors

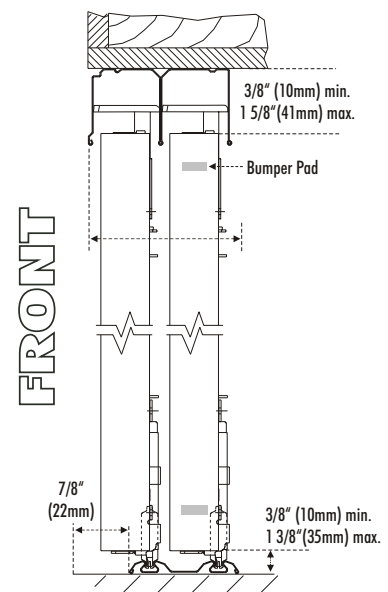

88171 Porte coulissante, à roulement inférieur sans cadre

Cet ensemble comprend:

- 8 vis longues
- 6 vis courtes
- 1 rail supérieur
- 1 rail inférieur
- 2 portes-miroirs coulissantes
- 2 poignées
- Tampons amortisseurs

Outils requis

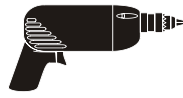

Perceuse (facultatif)



Scie à métaux



Ruban à mesurer



Tournevis Phillips

Étape un

Couper le rail selon l'embrasure (au besoin)
Couper les canal supérieur en "E" et le rail inférieur avec une scie à métaux à dents fines de façon qu'ils mesurent 1/16 po (2 mm) de moins que la largeur de l'embrasure.

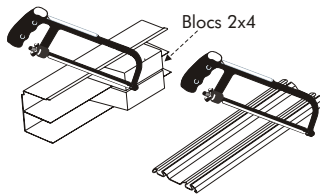

Étape deux

Poser le rail supérieur
Au moyen des vis longues, visser le canal en "E" à la tête, en plaçant le bord avant en retrait de 1/16 po (2 mm) à partir de la façade de l'encadrement, comme illustré.

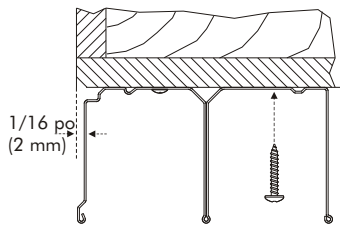

Étape quatre

Installer les portes

Pour protéger le rail inférieur, sortir les rouleaux du bas à 1/2 po (12 mm) avant d'installer (comme illustré à l'étape 3). Incliner la porte et insérer d'abord le haut dans le canal arrière. Enclencher les rouleaux du bas dans la rainure arrière du rail inférieur. Répéter pour la porte avant.



Étape cinq

Régler les portes

Pour mettre les portes à la verticale ou d'aplomb, utiliser un tournevis Phillips et régler les rouleaux du bas comme illustré.

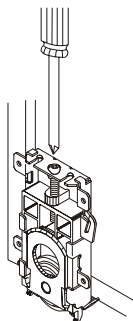

Étape six

Installer les poignées

Nettoyer la partie du miroir où sera posée la poignée (à environ 40 po (101 cm) de hauteur, à 1/2 po (1,3 cm) du bord extérieur de la porte) Peler le ruban protecteur et poser la poignée sur le miroir en appuyant fermement. La poignée ne peut être changée de place une fois qu'elle a été appliquée.

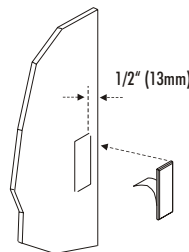

Étape trois A

Fixez le rail inférieur (pas de moquette):

Placez le côté extérieur du rail à fixer sur le plancher à 22mm (7/8 po) du cadre extérieur du montant de la porte de façon à ce que la porte soit bien montée à la verticale. Utilisez les vis courtes pour le rail inférieur.

Trois A

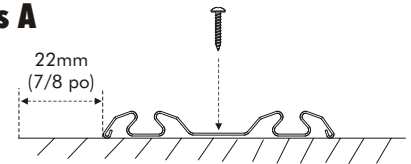

Trois B

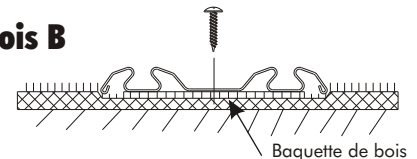

Plan transversal des portes installées

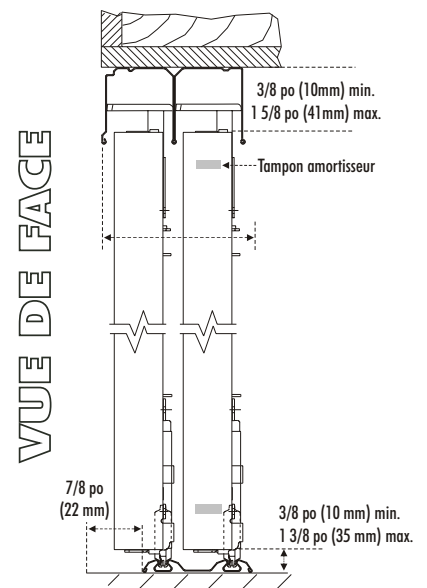

88171 Puerta corrediza, con rodillo inferior sin marco

Este paquete contiene

- 8 Tornillos largos
- 6 Tornillos cortos
- 1 Carril superior
- 1 Carril inferior
- 2 Puertas corredizas de espejo
- 2 Tiradores de espejo
- Tiras amortiguadoras

Herramientas Necesarias

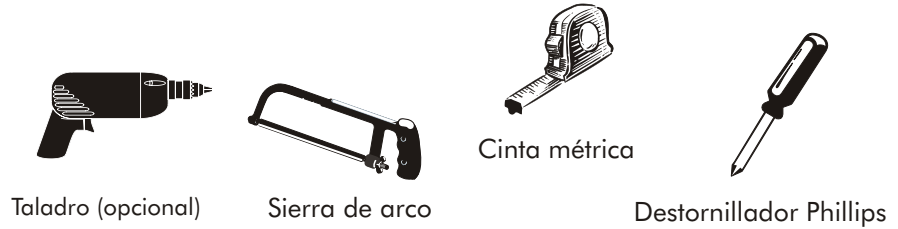

Paso uno

Recorte el carril para que encaje en la abertura (si fuera necesario)

Con una sierra de arco de dientes finos, corte el canal en "E" superior y el carril inferior 1/16" (2mm) más cortos que el ancho de la abertura.

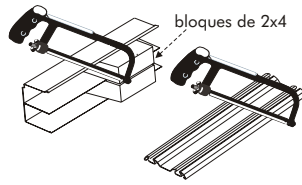

Paso tres A

Instale el carril inferior (sin alfombra):

Ubique el borde principal del carril del piso a 7/8" (22mm) de distancia de la cara frontal de la jamba, de modo que las puertas cuelguen perpendicularmente. Use los tornillos cortos para el carril inferior.

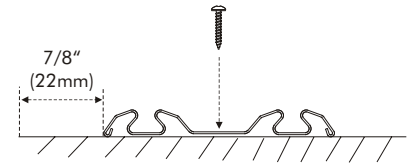

Paso dos

Instale el carril superior

Con los tornillos largos, antornille el canal en "E" al cabezal, ubicando el borde frontal 1/16" (2mm) más atrás de la cara de la jamba como se ilustra.

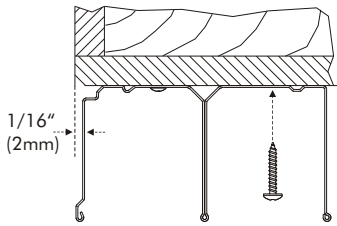

Paso tres B

Instale el carril inferior (con alfombra):

Coloque una tira de contrachapado que mida 2" de ancho x la longitud del carril inferior x 1/8" de grosor (mín.) Sobre la alfombra, como se ilustra.

Tres B

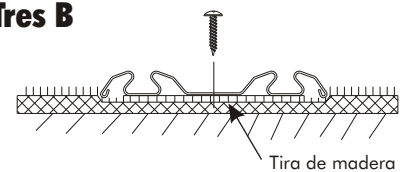

Paso cuatro

Instale las puertas

Para proteger el riel inferior, antes de la instalación, extienda los rodillos inferiores 1/2" (12mm) (como se ilustra en el paso tres). Incline la puerta en ángulo e introduzca primero la parte superior de la puerta en el canal posterior. Introduzca los rodillos inferiores dentro de las guías del carril inferior.

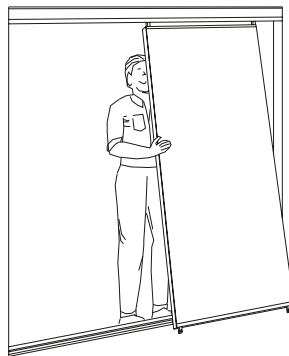

Paso cinco

Ajuste las puertas

Con el destornillador Phillips ajuste los rodillos inferiores como se ilustra, para ajustar verticalmente y aplomar las puertas.

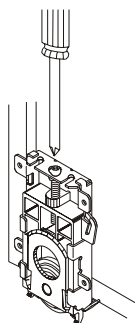

Paso seis

Pegue los tiradores de espejo

Limpie el área del espejo donde se quiere colocar el tirador (hacia dentro aproximadamente 40" (101 cm), 1/2" (1.3cm) desde el borde exterior de la puerta)

Despegue la cinta portectora y presione el tirador firmemente contra el espejo. Una vez que se haya aplicado, no se puede volver a colocar.



Diagrama del corte transversal de las puertas instaladas



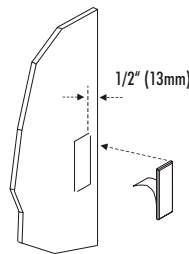
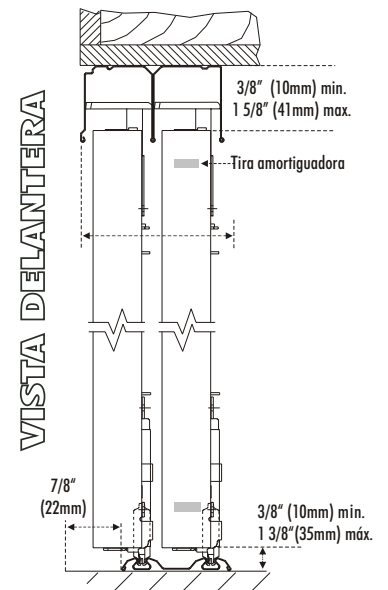

KingStar Products Inc.
3350 Langstaff Road, Concord, Ontario, Canada L4K 4Z6
Customer Service Direct: 1-800-493-5263

www.kingstar-inc.com

KINGSTAR PRODUCTS (WESTERN) INC.
1613 KEBET WAY, PORT COQUITLAM, BC, CANADA V3C 5W9
CUSTOMER SERVICE DIRECT: 1-800-421-6643