



Owner's Manual AQ-RO-3

Aquasana OptimH₂O™ Drinking Water System *Reverse Osmosis plus Claryum® Filtration Technology*

Welcome to the Aquasana experience. You are about to enjoy clean, clear water and the peace of mind that comes from knowing award winning filter technology is working for you.



System tested and certified by NSF International against NSF/ANSI Standard 42, 53 & 401 and conforms to NSF protocol P473 for reduction of claims specified on the Performance Data Sheet and at nsf.org.



The AQ-RO-3 system has been tested and certified by NSF International against NSF/ANSI Standard 58 for the reduction claims specified on the Performance Data Sheet as verified and substantiated by test data and at nsf.org.

REQUIRED TOOLS & MATERIALS

- Basic plumbing knowledge
- Tape Measure
- Utility Knife
- Screwdriver (Phillips)
- $\frac{1}{8}$ " & $\frac{3}{32}$ " Drill Bits/Drill
- Adjustable Wrench
- Bleach
- Safety Glasses
- Pencil
- Masking Tape
- Pan or Bucket



WHAT'S INCLUDED

- | | | |
|---|-------------------------------|--------------------------------|
| A System Manifold | H Water Storage Tank | P Tubing $\frac{1}{4}$ " White |
| B Carbon Filter Sump | I Eye Dropper | Q Tubing $\frac{3}{8}$ " White |
| C Membrane Filter Sump | J Tank Connector | R Tubing $\frac{3}{8}$ " Red |
| D Claryum Filter Sump | K Plumber's Tape | S Screws + Bracket |
| E Remineralizer | L Drain Connector | T Brass Tee |
| F Faucet | M Nuts & Bolts | U Carbon Filter Cartridge |
| G Gasket, Nut, Washer, Spacer, Quick Connector (for faucet) | N Foam Seal | V Claryum Filter Cartridge |
| | O Flow Restrictor & 90° Elbow | |

⚠️ WARNING: Using a qualified installer is recommended.

⚠️ **Proper installation is the responsibility of the installer.**

⚠️ **Product failure due to improper installation is not covered under the warranty.**

NOTE: Keep these instructions for future reference

PLAN FOR INSTALLATION

Prior to installation, we recommend you read the entire manual to familiarize yourself with the system, and help you determine the best location for installation. Please check and comply with all local plumbing codes.

PREPARE SITE FOR INSTALLATION

NOTE: If you have metal drain pipes, consult a plumber for installation of drain connection.

1. Prior to installation, close the cold water shut-off valve.

2. **Temporarily place system manifold, remineralizer, and tank into the under sink cabinet or desired location to ensure adequate space and proper positioning.**

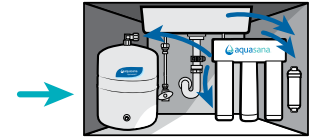

3. $\frac{3}{8}$ " white tubing will be used to connect manifold to tank, and from faucet stem to remineralizer. Measure out $\frac{3}{8}$ " white tubing from the top of the tank to the outlet side of the system manifold and mark $\frac{3}{8}$ " tubing. Then measure remaining length of $\frac{3}{8}$ " tubing from the remineralizer to the desired location of the faucet hole to ensure there will be enough $\frac{3}{8}$ " tubing available for both connections. Wait to cut tubing and follow instructions below.
4. Remove system, remineralizer, and tank from under your sink to begin installation.

INSTALLATION OVERVIEW

Step 1 - Install Brass Tee Fitting

Step 2 - Install RO System Manifold

Step 3 - Install Water Storage Tank

Step 4 - Install RO Faucet

Step 5 - Install RO Drain Connector

Step 6 - Connect Tubing

Step 7 - Stage 1-3 Filter Installation

Step 8 - Sanitize, Pressure Test, Purge System

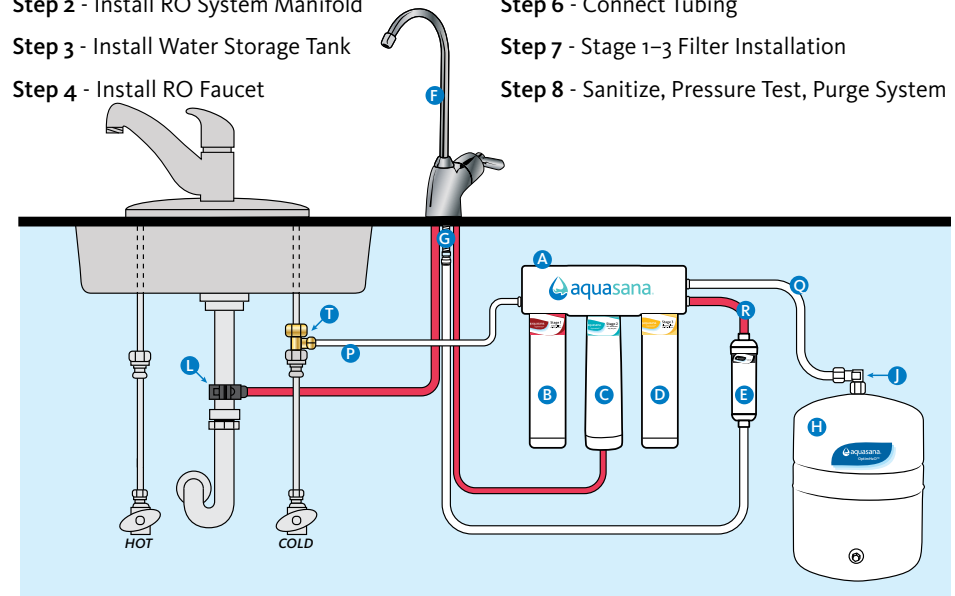

1 — INSTALL BRASS TEE FITTING

- 1 Turn off the cold water supply to the sink.
- 2 Turn on the kitchen faucet to release pressure and allow water to drain from the line.
- 3 Disconnect the cold water line from the ½" threaded stem on the bottom of the kitchen faucet. Attach threaded ends of supplied brass tee to the cold water supply line and shut-off valve; tighten using an adjustable wrench.
- 4 Attach ¼" white tube to the brass tee:

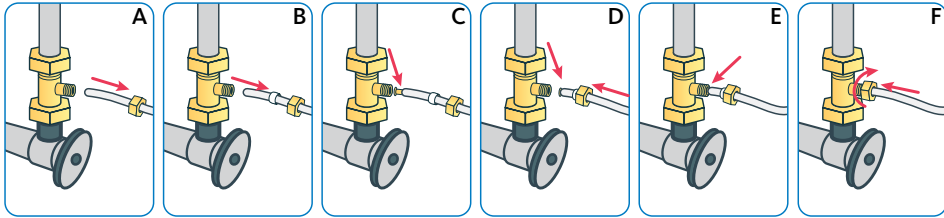

- A. Slide the compression nut onto the white tubing.
 - B. Slide the plastic sleeve onto the white tube.
 - C. Place brass insert into the opening of white tube.
 - D. Push the tip of the white tubing into the opening of the brass tee.
 - E. Slide the compression nut onto the threads of the brass tee.
 - F. While holding the white tube in place, tighten the compression nut to compress the plastic sleeve and create a seal. **NOTE: Use a wrench to ensure complete seal. Avoid over tightening.**
- 5 Do not connect the other end at this time.

2 — INSTALL SYSTEM MANIFOLD

- 1 Select an easily accessible area under the sink to mount system manifold and remineralizer holder. You want to allow at least a 4 to 6 inch clearance below the filters to the floor to allow ample space for filter changes. To help gauge the right location for your system manifold, insert first and third stage filter sumps into manifold. Insert sumps by aligning top connection points and push up and to the right until sumps are locked in.

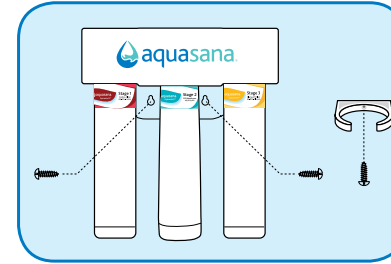
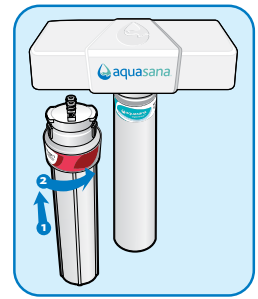

- 2 Mark wall placement for mounting screws using built-in bracket on back of manifold. Make sure holes are as level as possible. Mark screw placement of the remineralizer holder 1 or 2 inches from the third stage sump to the right of the manifold.
- 3 Drill two pilot holes for mounting brackets using ⅛" drill bit for the system manifold. **NOTE: Use caution not to drill into anything beyond the cabinet wall.**
- 4 Insert mounting screws into the wall leaving approximately ⅜" of each screw exposed.
- 5 Remove first and third filter sumps from manifold by turning each sump to the left and pulling down before hanging manifold on wall. Mount manifold on wall and screw in. Be careful not to over tighten.
- 6 Screw in remineralizer holder onto wall.

3 — INSTALL WATER STORAGE TANK



- 1 On the nipple on top of the tank, apply plumber's tape 4 or 5 times clockwise around in the same direction as the threads.
- 2 Hand tighten the tank connector onto the tank nipple until secure. **NOTE: Do not cross thread or over tighten.**
- 3 Using mount stand, place tank near the system manifold. Measure ⅜" white tubing to the outlet side of the system manifold and ensure you have enough tubing to connect tank and system manifold as well as enough left to attach faucet stem and remineralizer. Cut ⅜" white tubing.

- 4 Install the ⅜" white tubing to the tank:

- A. Push the tubing through the nut, collar and sleeve into the connector.
- B. Unscrew the compression nut from the tank connector to ensure that the tubing is connected all the way through the collar and sleeve.
- C. Slide the nut to the threads and tighten with a wrench. Avoid over tightening.

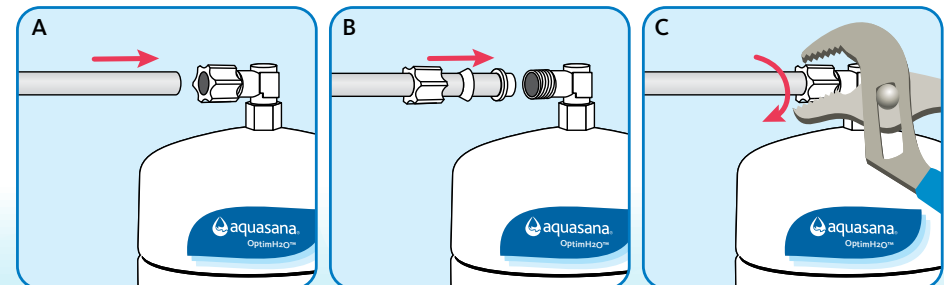

4 — INSTALL RO FAUCET

You will need a sink top hole 1" in diameter. If drilling a new hole, ensure faucet body will mount flat against surface and that there is sufficient tubing between faucet body and system manifold. **NOTE:** Drilling holes into solid surfaces or surfaces made of stone should only be performed by a qualified and certified installer.

- 1 Place the black rubber gasket into the groove of the faucet base and feed the tubing and faucet threads through the countertop hole.
- 2 Underneath counter, slide on the slotted washer, spacer and nut. Tighten with wrench.
- 3 Tighten the white quick connector onto the base of the faucet threads.
- 4 Attach $\frac{3}{8}$ " white tubing by inserting into quick connector approximately $\frac{5}{8}$ " until it stops. Gently tug on the tubing to ensure it is firmly seated in fitting.

NOTE: Do not connect $\frac{3}{8}$ " white tubing from tank to faucet.

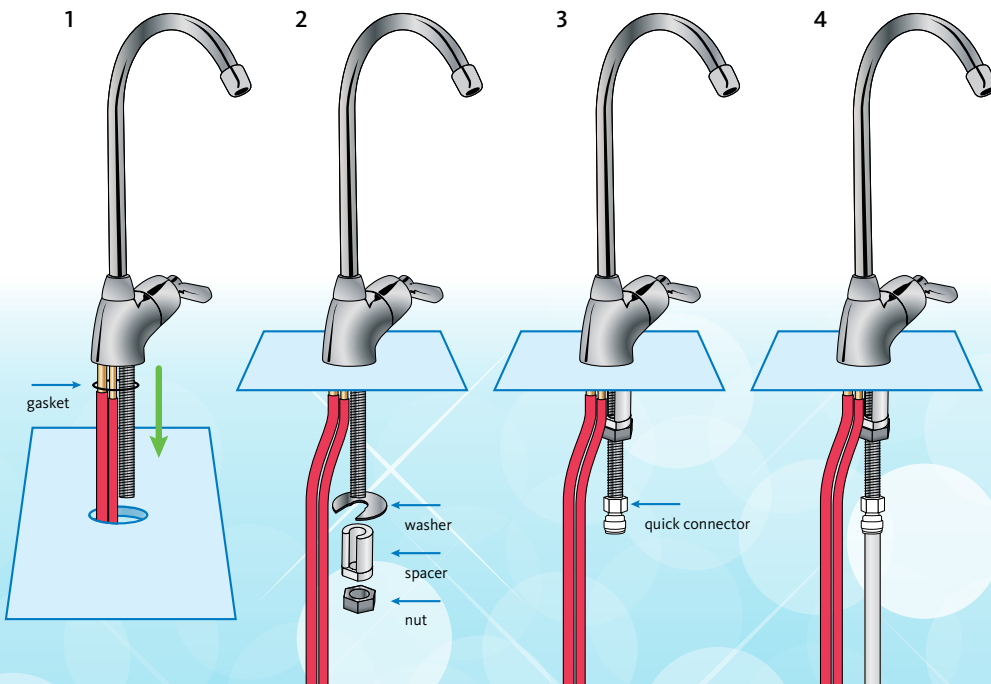

5 — INSTALL RO DRAIN CONNECTOR



WARNING

Be sure that all electrical appliances and outlets are turned off at the circuit breaker before working in the cabinet area.



CAUTION

Please wear safety glasses to protect eyes when drilling.

- 1 Identify drain outlet location. Do NOT install the drain connector onto the same drain pipe as the garbage disposal whenever possible.
- 2 Remove protective cover from back of foam seal.
- 3 Knock center hole out, align holes, and attach to front plate of drain connector.
- 4 Allowing room for drilling, position the drain connector on sink drain pipe above drain trap.
- 5 Securely tighten nuts and screws.
- 6 Using the drain connector port as a drill guide, drill a $\frac{7}{32}$ " hole into the drain pipe. Be sure not to penetrate opposite side of pipe, or to damage side of the drain port fitting.

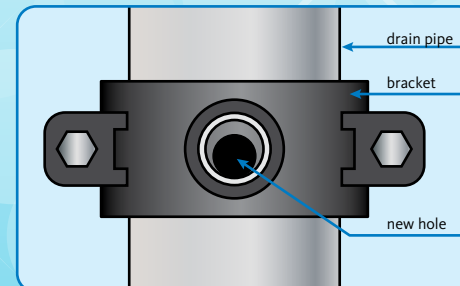
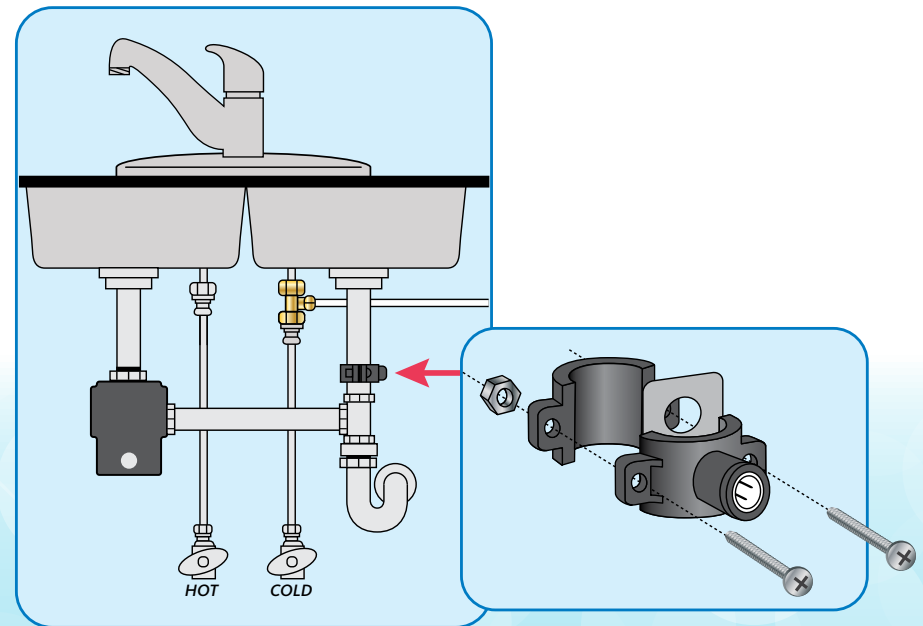

Pro Tip

If there is leakage from the drain bracket, loosen the bolts and slide the bracket up so the drilled hole is at the bottom of the drain connector port.

6 — CONNECT TUBING

Tube Marking Guide:

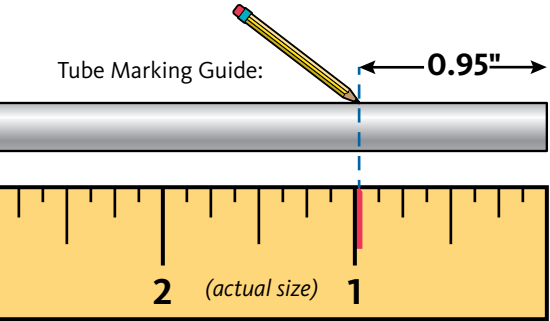

Tubing Do's

Insert tubing **ALL THE WAY IN** to prevent leaking. In most cases, up to nearly a full inch. Wet end of tubing to more easily insert into all inlets and outlets.
Cut excess tubing in order to prevent crimping, kinks, loops or folds.

Tubing Dont's

DO NOT cut tubing too short. Always double check measurements before cutting.
DO NOT bend or crimp or kink tubing.
DO NOT discard excess tubing.

I: Brass Tee to Manifold "INLET" (1/4" white tubing)

- 1 Take the white tubing leading from the brass tee and insert it into the manifold port labeled "INLET". Remember to push it all the way in until it stops.

II: Manifold to Remineralizer (3/8" red tubing included in packaging)

- 1 Insert one end into the manifold port labeled "FAUCET".
- 2 Insert the other end into the remineralizer port labeled "INLET".

III: Remineralizer to Faucet (3/8" white tubing already attached to faucet)

- 1 Insert the 3/8" white tubing (that was installed in step 4) from the faucet into the remineralizer port labeled "OUTLET".

IV: Manifold to Tank (3/8" white tubing already attached to tank)

- 1 Take the white tubing leading from the storage tank and insert it into the manifold port labeled "TANK". Remember to push it all the way in until it stops.

V: Air Gap to RO Membrane (1/4" red tubing from faucet)

- 1 Insert restrictor into the end of the red tubing.
- 2 Attach 1/4" red tubing to the 90° elbow until it stops.
- 3 Attach 1/4" 90° elbow to the membrane drain port.

VI: Faucet to Drain Connector (3/8" red tubing from faucet)

- 1 Take the 3/8" red tubing from faucet and insert it all the way into the drain connector.

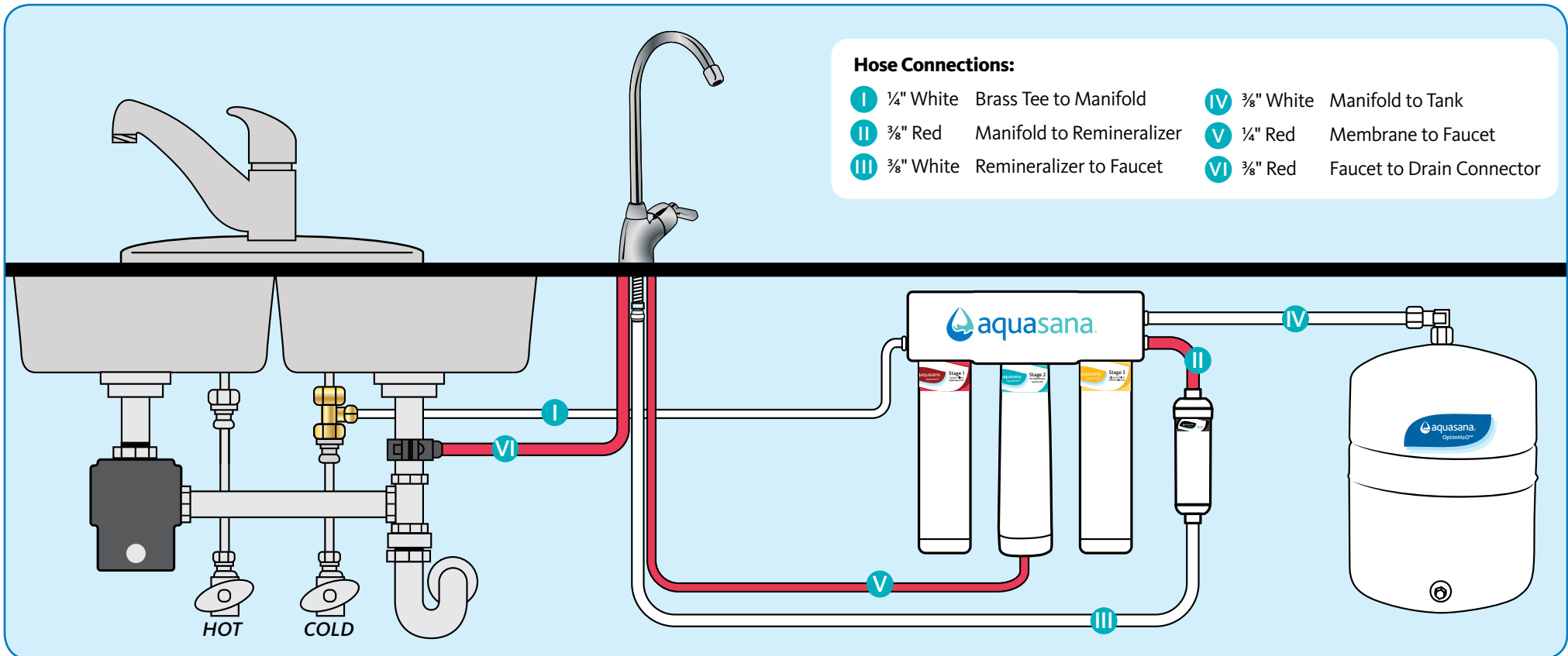
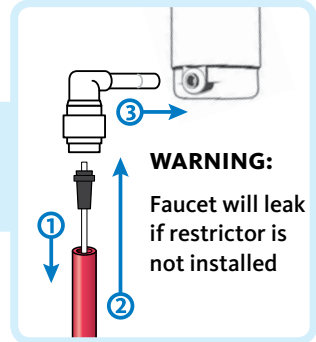

Hose Connections:

- | | | | |
|----------------|---------------------------|---------------|---------------------------|
| I 1/4" White | Brass Tee to Manifold | IV 3/8" White | Manifold to Tank |
| II 3/8" Red | Manifold to Remineralizer | V 1/4" Red | Membrane to Faucet |
| III 3/8" White | Remineralizer to Faucet | VI 3/8" Red | Faucet to Drain Connector |

7 — STEP 1-3 FILTER INSTALLATION

Before you begin: make sure the cold water valve is shut off and there is no pressure in the system. Carbon (red) and Claryum (yellow) filter cartridges will come pre-installed in their cartridge sumps.

- 1 Attach red carbon sump to the 1st stage position on the inlet side of the system manifold. Make sure all connection points are aligned and push the top of the sump up and into the system manifold. Turn it towards the right until it locks in.
- 2 Repeat step 1 for the 2nd Stage RO membrane that goes in the center, and for the yellow Claryum cartridge in the 3rd stage position on the outlet side of the system manifold.

Be sure to turn 2nd stage RO membrane all the way to the right, until drain port on cartridge is facing the rear of the system.

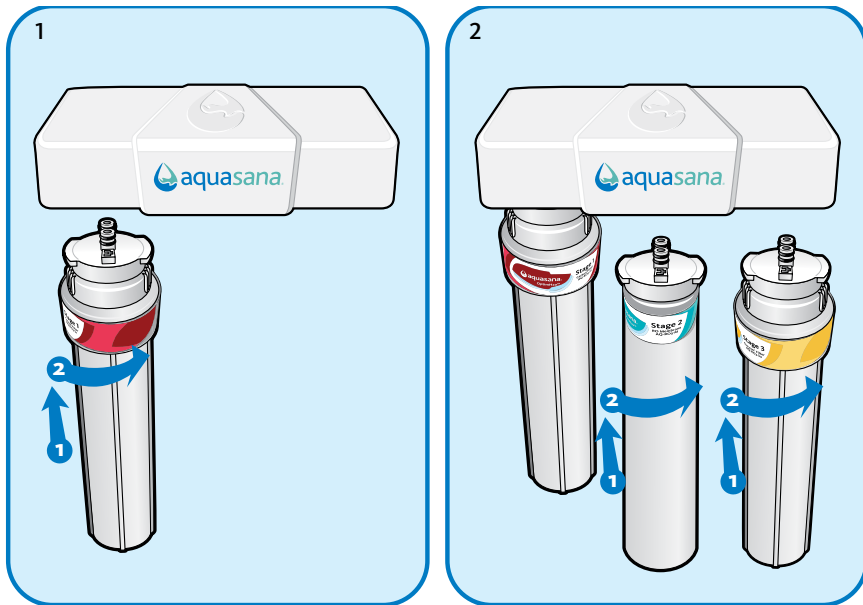

8 — SANITIZE, TEST & PURGE

Sanitize

Note: Sanitization is recommended immediately after RO Filter System installation and any inner-part servicing. The person sanitizing should have clean hands during this process.

- 1 Shut off water supply to RO system.
- 2 Open faucet. If tank is not empty, allow to drain until empty.
- 3 With included eyedropper and household bleach (5.25%), disconnect white tubing from the manifold outlet labeled "TANK".
Note: Bleach needs to be handled according to manufacturer's instructions.
- 4 Add 3ml bleach into open end of tank white tubing.
- 5 Reconnect the tank from the tube into the manifold outlet labeled "TANK". Be sure to push tubing in all the way.
- 6 Sanitization will be completed during the following pressure test and purge. Important: Bleach must be completely removed from system before drinking water. See Purge instructions below.

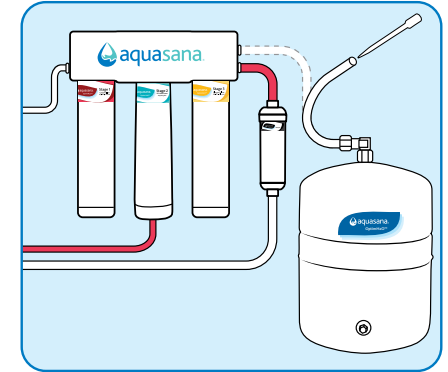

Pressure Test

Important: Complete sanitization prior to pressure test.

- 1 Open cold water supply valve to RO Filter System.
- 2 To purge air from the plumbing system, open kitchen faucet. Close faucet when water runs smooth.
- 3 Confirm RO faucet is closed.
- 4 Within approximately 2 hours, pressure will start to build in the RO Filter System. Carefully inspect all connections and fittings while this pressure buildup occurs.
- 5 Check for leaks. If leaks are found, fix by ensuring all tubing is cut squarely and fully inserted. Also confirm there are no scratches, dents or notches at tubing end. If there are, squarely cut 1" off and re-insert.

Note: When RO Filter System is first pressurized, water may project from faucet air gap hole until air is passed from RO Filter System.

Purge

- 1 Open RO faucet and let water flow through system for 24 hours.
Note: Flow rate will be slow during this time.

- 2 Close RO faucet after purge is complete.

Note: Your RO Filter System is ready for use when purge is complete, however, you will not have filtered water immediately. It takes 1-3 hours to completely fill the tank. The flow rate will be less than your kitchen faucet. Water will run to the drain while the RO Filter System is filtering water – even when not in use. This is normal. Water going to drain will stop automatically when tank is at capacity.

3-STAGE RO SYSTEM – MODEL AQ-RO-3		
	U.S.	Metric
Membrane Production ¹	35 gpd	132 lpd
Membrane TDS Reduction ¹	95% minimum	95% minimum
System Production ²	13.32 gpd	50.4 lpd
TDS Reduction ²	96.3%+ average	96.3%+ average
Maximum TDS	1000 ppm	1000 ppm
Maximum water hardness @ 6.9pH	10 gpg	2.64 gpL
Maximum Chlorine in water	3.0 ppm	3.0 ppm
Supply water pH limits	4-10	4-10
Drain (reject water) Flow	3-5 x product flow	3-5 x product flow
Empty Storage Tank Precharge	5-7 psi air	35-48 kPa air
Storage Tank Capacity ²	3.2 gallons	12.11 liters
Supply water pressure limits	40-100 psi	275-689 kPa
Supply water temperature limit	40-100° F	5-37° C
Efficiency ³	17.91%	17.91%
Recovery ⁴	29.43%	29.43%

Specifications – Qualified System Performance

Because the performance of a Reverse Osmosis Membrane is highly dependent upon pressure, temperature and TDS, the following should be used for comparison purposes only.

- 1 Industry standards measure RO Membranes performance with no back pressure on the product water, at 60 psig (414kPa) and 77°F (25°C). Further conditions on the above are 250 ppm TDS and a 30.6% recovery rate. Production rate and TDS reduction figures are for a new Membrane that has been rinsed for 24 hours. The production rate of a new Membrane can decrease by 10% per year or more, depending upon the scaling and fouling tendencies of the Feed Water.
- 2 Measured at 50 psi, 77°±2°F, and 717 mg/l TDS per NSF/ANSI Standard 58.
- 3 Efficiency rating means the percentage of the influent water to the system that is available to the user as reverse osmosis treated water. Under operating conditions that approximate typical daily usage.
- 4 Recovery rating means the percentage of the influent water to the membrane portion of the system that is available to the user as reverse osmosis treated water when the system is operated without a storage tank or when the storage tank is bypassed.

 Do not use with water that is microbiologically unsafe or of unknown water quality without adequate disinfection before or after the system. Systems certified for cyst reduction may be used on disinfected waters that may contain filterable cysts.

 Filter is only to be used with cold water. Systems certified for cyst reduction may be used on disinfected water that may contain filterable cysts.

Non-potable Water Sources:

Do not attempt to use this product to make safe drinking water from non-potable water sources. Do not use the system on microbiologically unsafe water, or water of unknown quality without adequate disinfection before or after the system. This system is certified for cyst reduction and may be used on disinfected water that may contain filterable cysts.

Arsenic Reduction:

Arsenic (abbreviated As) is found naturally in some well water. Arsenic in water has no color, taste, or odor. It must be measured by a laboratory test. Public water utilities must have their water tested for arsenic. You can get the results from your water utility. If you have your own well, you can have the water tested. The local health department or the state environmental health agency can provide a list of certified labs. The cost is typically \$15 to \$30. Information about arsenic in water can be found on the Internet at the U.S. Environmental Protection Agency website: www.epa.gov/safewater/arsenic.html.

There are two forms of arsenic: pentavalent arsenic (also called As(V), As(+5), and arsenate) and trivalent arsenic (also called As(III), As(+3), and arsenite). In well water, arsenic may be pentavalent, trivalent, or a combination of both. Special sampling procedures are needed for a lab to determine what type and how much of each type of arsenic is in the water. Check with the labs in your area to see if they can provide this type of service.

Reverse osmosis (RO) water treatment systems do not remove trivalent arsenic from water very well. RO systems are very effective at removing pentavalent arsenic. A free chlorine residual will rapidly convert trivalent arsenic to pentavalent arsenic. Other water treatment chemicals such as ozone and potassium permanganate will also change trivalent arsenic to pentavalent arsenic. A combined chlorine residual (also called chloramine) may not convert all the trivalent arsenic. If you get your water from a public water utility, contact the utility to find out if free chlorine or combined chlorine is used in the water system.

The AQ-RO-3 system is designed to remove pentavalent arsenic. It will not convert trivalent arsenic to pentavalent arsenic. The system was tested in a lab. Under testing conditions, the system reduced 0.3 mg/L (ppm) pentavalent arsenic to 0.010 mg/L (ppm) (the USEPA standard for drinking water) or less. The performance of the system may be different at your installation. Have the treated water tested for arsenic to check whether the system is working properly.

The RO component of the AQ-RO-3 system must be replaced every 1-3 years to ensure that the system will continue to remove pentavalent arsenic. The component identification and locations where you can purchase the component are listed in the installation/operation manual.

Nitrate/Nitrite Test Kit:

This system is acceptable for treatment of influent concentration of no more than 27mg/L nitrate and 3mg/L nitrite in combination measured as N.* This system is supplied with a nitrate/nitrite test kit. Product water should be monitored periodically according to the instructions provided with the test kit.

Installations in The Commonwealth of Massachusetts:

The Commonwealth of Massachusetts requires installation be performed by a licensed plumber and do not permit the use of saddle valves. Plumbing code 248—CMR of the Commonwealth of Massachusetts must be followed in these cases.

Carbon Pre-Filter & Claryum® Post-Filter - *Change every 6 months**

The carbon and Claryum filter cartridges are replaceable activated carbon cartridges located in stages 1 and 3. It is recommended replacing these cartridges at least every 6 months. You may need to replace more often with high water usage or high sediment level. Replacing these cartridges timely will protect the RO membrane from high levels of chlorine and/or sediment. As these filters build up with sediment, you may notice slower water output.

RO Membrane Cartridge - *Change every 12 months*

The RO membrane is located in stage 2. This membrane reduces the dissolved solids and organic matter. Most municipally treated water has a 7.0-7.5 pH, in this case you would need to replace your RO membrane every 12 months. Membrane life depends on pH and supply water hardness. Higher pH shortens membrane life by causing pin-hole leaks, and would shorten membrane life. When output and water quality and production rate decrease, it is time to replace the filter sump.

Remineralizer - *Change every 12 months**

Important: For the first 36 hours after the initial installation, make sure to periodically inspect for leaks while the system is running and while it is turned off. If a leak occurs, shut off the water supply, open up the filter faucet to release pressure from the system & contact Aquasana Technical Support 866.662.6885.

If you are adding the remineralizer to a system that has already been installed, shut off the filter faucet, turn on the water supply and allow the RO tank to fill up completely. Once the tank is completely filled, flush & saturate the remineralizer cartridge by opening up the filter faucet and allowing the purified water to run through the remineralizer for 3 minutes. The water may come out cloudy during the initial flush.

Flow rate and output are determined by 3 factors:

- 1 Incoming water temperature
- 2 Total dissolved solids (TDS) present in supply water
- 3 Incoming water pressure

Lower temperatures are directly proportional to slower flow rate. All membranes are tested at 77°F. Incoming water temperature should not exceed 100°F. The RO Filter System should also not be installed in a location susceptible to freezing. The more TDS in the supply water, greater filter time is required. Incoming TDS should not exceed 1000 ppm. Higher water pressure enables a higher flow rate. Pressure must be above 40 psi for proper system operation. You may consider installing a permeate pump or booster pump if your pressure is below 40 psi.

Drain Flow Restrictor

The restrictor is vital for proper operation of the RO membrane cartridge as it keeps water flowing through the membrane at the proper rate ensuring the water produced is the best quality. It is recommended the restrictor assembly be periodically inspected to be sure it is clean and unrestricted. If service is required on the drain flow assembly, disassemble and reassemble as outlined in Step Six.

**Filter life depends on water usage and water supply quality.
Faucet is not part of NSF Certification*



Pure Satisfaction

All Aquasana products offer a 90-day satisfaction guarantee. (A 2 year warranty is included, which covers defects in materials and workmanship.) If for any reason you are not satisfied with your purchase, simply call us, or the dealer you purchased from, for a Return Authorization Code and a full refund will be promptly issued upon return. Thank you for choosing Aquasana!

This filter system is designed and tested for use with genuine Aquasana parts including replacement filters and all hardware. Use of parts from other manufacturers may result in loss of contaminant reduction performance, system damage or failure. Use of parts from other manufacturers will also void your warranty. Please visit aquasana.com for all replacement parts.



Aquasana, Inc.

6310 Midway Road · Haltom City, Texas 76117
866.662.6885 USA · 877.332.7873 Canada
www.aquasana.com

For exclusive deals

 facebook.com/aquasana
 twitter.com/aquasana



System tested and certified by NSF International against NSF/ANSI Standard 42, 53 & 401 and conforms to NSF protocol P473 for reduction of claims specified on the Performance Data Sheet and at nsf.org.



The AQ-RO-3 system has been tested and certified by NSF International against NSF/ANSI Standard 58 for the reduction claims specified on the Performance Data Sheet as verified and substantiated by test data and at nsf.org.