

Mini Pendant Light

Model 7210

INSTALLATION MANUAL

TROUBLESHOOTING:

	Possible Cause	Corrective Action
Light will not turn on.	<ol style="list-style-type: none"> 1. Power is off. 2. Faulty switch. 3. Faulty wire connection. 	<ol style="list-style-type: none"> 1. Make sure power supply is on. 2. Test or replace switch. 3. Check wiring.
Fuse blows or circuit breaker trips when light is turned on.	<ol style="list-style-type: none"> 1. Crossed wires or power wire is grounding out. 	<ol style="list-style-type: none"> 1. Check wire connections.

PRODUCT MAINTENANCE:

1. To clean the outside of the fixture, use a dry or slightly dampened clean cloth (use clean water, never a solvent) to wipe the surface of the fixture.
2. To clean the inside of the fixture, first disconnect power to the fixture by turning off the circuit breaker or by removing the fuse at the fuse box. Next, use a dry or slightly dampened clean cloth (use clean water, never a solvent) to wipe the interior surface of the fixture.
3. Do not use any cleaners with chemicals, solvents or harsh abrasives. Use only a dry soft cloth to dust or wipe carefully.

LIMITED WARRANTY

The manufacturer warrants this lighting fixture to be free from defects in materials and workmanship for a period of two (2) years from date of purchase. This warranty applies only to the original consumer purchaser and only to products used in normal use and service. If this product is found to be defective, the manufacturer's only obligation, and your exclusive remedy, is the repair or replacement of the product at the manufacturer's discretion, provided that the product has not been damaged through misuse, abuse, accident, modifications, alterations, neglect or mishandling. This warranty shall not apply to any product that is found to have been improperly installed, set-up, or used in any way not in accordance with the instructions supplied with the product. This warranty shall not apply to a failure of the product as a result of an accident, misuse, abuse, negligence, alteration, or faulty installation, or any other failure not relating to faulty material or workmanship. This warranty shall not apply to the finish on any portion of the product, such as surface and/or weathering, as this is considered normal wear and tear. The manufacturer does not warrant and specially disclaims any warranty, whether expressed or implied, of fitness for a particular purpose, other than the warranty contained herein. The manufacturer specifically disclaims any liability and shall not be liable for any consequential or incidental loss or damage, including but not limited to any labor/expense costs involved in the replacement or repair of said product.

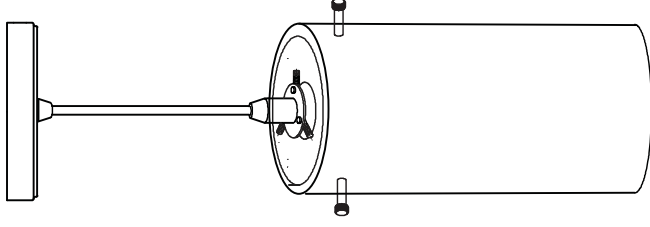



Installation

⚠ DANGER: Before installation, turn off the main power at the circuit breaker.

⚠ WARNING: Installation must be performed by a qualified licensed electrician.

TOOLS REQUIRED FOR INSTALLATION AND ASSEMBLY (not included):

- 

Phillips screwdriver
- 

Flathead screwdriver
- 

Wire cutters
- 

Wire strippers
- 

Safety goggles
- 

Electrical tape

1 Adjusting the cord length

- A. Remove the canopy housing screws (C) and canopy housing.
- B. Loosen the cord set screw (J).
- C. Pull the cord through the canopy housing (B) to the desired length.
- D. Pull the cord through the cord lock (F).
- E. Cut the excess cord.

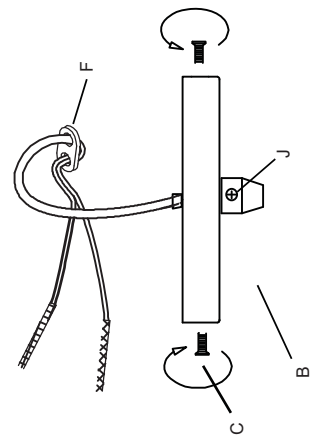

2 Removing the existing fixture

- A. Remove the existing fixture.

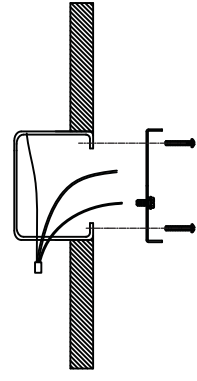

4 Installing the ceiling fixture

- A. Tuck the fixture wires into the ceiling box.
- B. Slide up the Canopy Housing bracket and secure with Canopy Housing screws (C).
- C. Check the fixture rod set screw (J) and tighten if necessary. Do not over tighten.
- D. Install the Glass Globe (D) with metal threaded decorative thumb screws (G) through the globe into the fixture housing. Do not over tighten. Install light bulb.

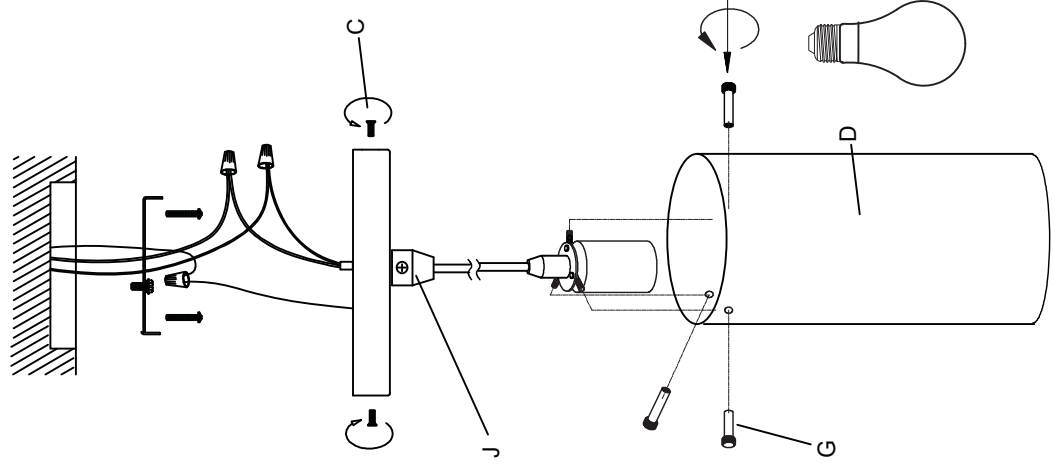

3 Connecting the wires

- A. Connect the white supply wire to the white fixture wire.
- B. Connect the black supply wire to the black fixture wire.
- C. Connect the ground supply wire to the ground fixture wire.
- D. Use wire nuts to secure all connections.

