

BLACK+ DECKER

FLEX™ VAC

INSTRUCTION MANUAL

CATALOG NUMBERS

BDH1220FL

BDH1620FL

BDH1620FLFH

BDH2020FLFH

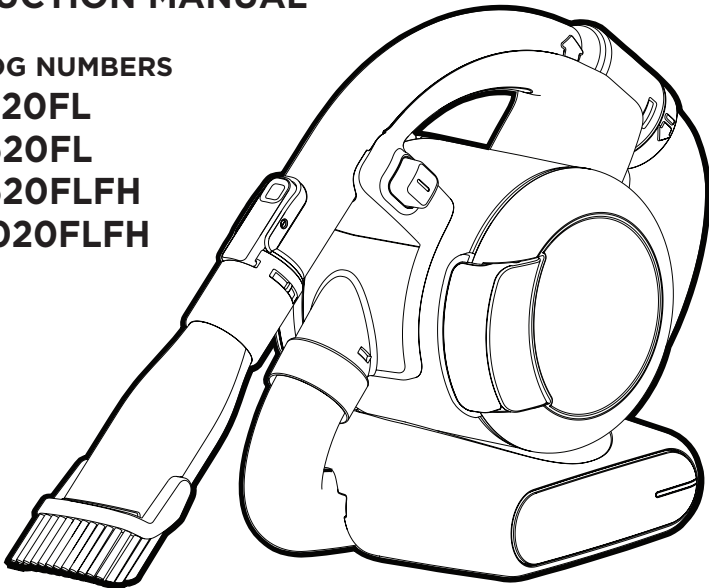

PLEASE READ BEFORE RETURNING THIS PRODUCT FOR ANY REASON.

If you have a question or experience a problem with your Black+Decker purchase, go to <http://www.blackanddecker.com/instantanswers>
If you can't find the answer or do not have access to the Internet, call 1-800-544-6986 from 8 a.m. to 5 p.m. EST Mon. - Fri. to speak with an agent. Please have the catalog number available when you call.

SAVE THIS MANUAL FOR FUTURE REFERENCE.

VEA EL ESPAÑOL EN LA CONTRAPORTADA.
INSTRUCTIVO DE OPERACIÓN, CENTROS DE SERVICIO Y PÓLIZA DE GARANTÍA.
ADVERTENCIA: LÉASE ESTE INSTRUCTIVO ANTES DE USAR EL PRODUCTO.

To register your new product, call 1-800-544-6986
or visit www.BlackandDecker.com/NewOwner

SAFETY GUIDELINES - DEFINITIONS

It is important for you to read and understand this manual.

The information it contains relates to protecting YOUR SAFETY and PREVENTING PROBLEMS. The symbols below are used to help you recognize this information.

⚠ DANGER: Indicates an imminently hazardous situation which, if not avoided, will result in death or serious injury.

⚠ WARNING: Indicates a potentially hazardous situation which, if not avoided, could result in death or serious injury.

⚠ CAUTION: Indicates a potentially hazardous situation which, if not avoided, may result in minor or moderate injury.

NOTICE: Used without the safety alert symbol indicates potentially hazardous situation which, if not avoided, may result in property damage.

IMPORTANT SAFETY INSTRUCTIONS

When using an electrical appliances, basic precautions should always be followed, including the following:

READ ALL INSTRUCTIONS BEFORE USING THE APPLIANCE.

⚠ WARNING: Read all safety warnings and all instructions. Failure to follow the warnings and instructions listed below may result in electric shock, fire and/or serious injury.

⚠ WARNING: Some household dust contains chemicals known to the State of California to cause cancer, birth defects or other reproductive harm such as asbestos and lead in lead based paint.

- ⚠ WARNING:** To reduce the risk of fire, electrical shock or injury:
- Close supervision is necessary when any appliance is used by or near children. Do not allow to be used as a toy.
 - **Shock Hazard.** To protect against risk of electrical shock, do not put unit or charging base in water or other liquid.
 - Do not use dry hand vacs to pick up liquids, toxic substances, flammable or combustible liquids such as gasoline or use in areas where they may be present.
 - Do not use wet/dry hand vacs to pick up toxic substances, flammable or combustible liquids such as gasoline or use in areas where they may be present.
 - Do not operate in the presence of explosives and/or flammable fumes or liquids.
 - **Shock Hazard.** Do not operate any appliance with a damaged cord or charger or after the appliance malfunctions, is left outdoors, dropped into water or is damaged in any manner. Return the appliance to any authorized service facility.
 - Do not use dry hand vacs outdoors or on wet surfaces.
 - Do not abuse the cord. Never carry the charger or base by the cord or yank to disconnect from an outlet; instead grasp the charger and pull to disconnect. Keep cord away from heated surfaces. Do not pull cord around sharp edges or corners.
 - Do not allow the cord to hang over the edge of a table or counter or touch hot surfaces. The unit should be placed or mounted away from sinks and hot surfaces.
 - Do not use an extension cord. Plug the charger directly into an electrical outlet.
 - Use the charger only in a standard electrical outlet (120V/60Hz).
 - Do not attempt to use the charger with any other product; do not attempt to charge this product with any other charger. Use only the charger supplied by the manufacturer to recharge.
 - Keep hair, loose clothing, and all parts of body away from openings and moving parts.
 - Do not insert accessories when unit is running.
 - **Shock Hazard.** Do not handle plug or appliance with wet hands.
 - Do not put any object into unit openings. Do not use with any openings blocked; keep free of dust, lint, hair, and anything that may reduce air flow.
 - **Fire Hazard.** Do not vacuum burning or smoking materials, such as lit cigarette butts, matches or hot ashes.
 - Do not charge the unit outdoors
 - Do not use on or near hot surfaces.
 - Use extra caution when cleaning on stairs.

- This appliance is intended for household use only and not for commercial or industrial use.
- Use only as described in this manual. Use only manufacturer's recommended attachments.
- Unplug the charger from outlet before any routine cleaning or maintenance.
- This product includes rechargeable Lithium Ion batteries. Do not incinerate batteries as they will explode at high temperatures.
- **If battery contents come into contact with the skin, immediately wash area with mild soap and water.** If battery liquid gets into the eye, rinse water over the open eye for 15 minutes or until irritation ceases. If medical attention is needed, the battery electrolyte for Lithium Ion batteries are composed of a mixture of liquid organic carbonates and lithium salts.

⚠ WARNING: Do not look into the air vents when the unit is switched on, as sometimes there is a possibility of small debris being discharged from the air vents, especially after cleaning / replacement of the filters as debris inside the unit can be disturbed.

- The charger supplied with this product is intended to be plugged in such that it is correctly orientated in a vertical or floor mount position.

SAFETY WARNINGS AND INSTRUCTIONS: BATTERIES

- Do not disassemble or open, drop (mechanical abuse), crush, bend or deform, puncture, or shred.
- Do not modify or remanufacture, attempt to insert foreign objects into the battery, immerse or expose to water or other liquids, or expose to fire, excessive heat including soldering irons, or put in microwave oven.
- Only use the battery / tool with a charging system specified by the manufacturer/supplier.
- Do not short-circuit a battery or allow metallic or conductive objects to contact both battery terminals simultaneously.
- Dispose of used batteries promptly according to the manufacturer/supplier's instructions.
- Improper battery use may result in a fire, explosion, or other hazard.
- Battery / tool usage by children should be supervised.

SAFETY WARNINGS AND INSTRUCTIONS: CHARGING

1. This manual contains important safety and operating instructions.
2. Before using battery charger, read all instructions and cautionary warnings on battery charger and product using battery. **⚠ CAUTION:** To reduce the risk of injury, use this charger only with this product. Batteries in other products may burst causing personal injury or damage.
3. Do not expose charger to rain or snow.
4. Use of an attachment not recommended or sold by Black+Decker may result in a risk of fire, electric shock, or injury to persons.
5. To reduce risk of damage to electric plug and cord, pull by plug rather than cord when disconnecting charger.
6. Make sure cord is located so that it will not be stepped on, tripped over, or otherwise subjected to damage or stress.
7. An extension cord should not be used unless absolutely necessary. Use of improper extension cord could result in a risk of fire, electric shock or electrocution.
8. Use only the supplied charger when charging your tool. The use of any other charger could damage the tool or create a hazardous condition.
9. Use only one charger when charging.
10. Do not attempt to open the charger. There are no customer serviceable parts inside. Return to any authorized Black+Decker service center.
11. **DO NOT** incinerate the tool or batteries even if they are severely damaged or completely worn out. The batteries can explode in a fire. Toxic fumes and materials are created when lithium ion battery packs are burned.
12. Do not charge or use battery in explosive atmospheres, such as in the presence of flammable liquids, gases or dust. Inserting or removing the battery from the charger may ignite the dust or fumes.
13. If battery contents come into contact with the skin, immediately wash area with mild soap and water. If battery liquid gets into the eye, rinse water over the open eye for three minutes or until irritation ceases. If medical attention is needed, the battery electrolyte is composed of a mixture of liquid organic carbonates and lithium salts.

⚠ WARNING: **Burn hazard.** Battery liquid may be flammable if exposed to spark or flame.

Symbols

- The label on your tool may include the following symbols. The symbols and their definitions are as follows:

V.....volts

Hz.....hertz

min.....minutes

== or DC ..direct current

Ⓛ.....Class I Construction
(grounded)

□.....Class II Construction
(double insulated)

A.....amperes

W.....watts

~ or AC.....alternating current

n_0no load speed

⊕.....earthing terminal

⚠.....safety alert symbol

.../min or rpm..revolutions or reciprocation
per minute

SAVE THESE INSTRUCTIONS

PRODUCT FEATURES (FIGURE A)

- On/off power switch
 - Removable handle
 - Locking ring
 - Hose
 - Dust container door
 - LED charging indicator
 - Battery housing
 - Door latch
 - Bowl release button
 - Removable bowl
 - Accessory clip
 - 2-in-1 nozzle accessory
 - Crevice tool
 - Pet hair tool (BDH2020FLFH, BDH1620FL ONLY)
 - Charging base
 - Accessory storage mounts
- BDH1620FLFH, BDH2020FLFH ONLY:**
- Floor head adapter
 - Floor head extensions
 - Extension connector
 - Floor head

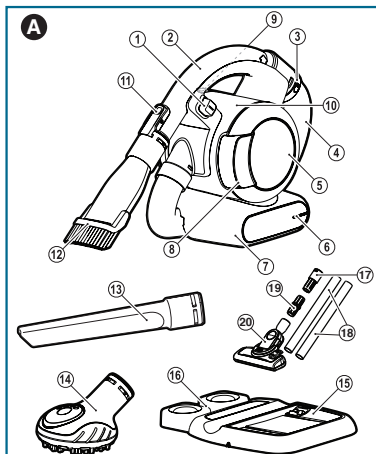

ASSEMBLY

ACCESSORY STORAGE MOUNTS

Snap accessory storage mounts (16) onto the side of the charging base (15) so the entire assembly appears as shown in **Figure A**. This allows for convenient storage of all accessories.

MOUNTING ACCESSORIES (FIGURES B - D)

The 2-in-1 nozzle / brush tool (12) has a brush that can be folded forward for dusting and upholstery cleaning. The pet hair cleaning tool (14) (BDH2020FLFH, BDH1620FL ONLY) is for use when vacuuming pet hair and/or ground-in debris from carpeted or upholstery surfaces.

⚠ WARNING: Injury to pets. Do not use pet hair cleaning tool directly on animals.

The crevice tool (13) allows for vacuuming in narrow and hard-to-reach places.

- To attach an accessory, press the accessory clip (11) and slide the accessory onto the handle (2).
- To remove an accessory, press the accessory clip (11) and remove the accessory.

To unwrap and extend the handle and hose:

The handle and hose can be unwrapped from the main appliance for extended reach when cleaning.

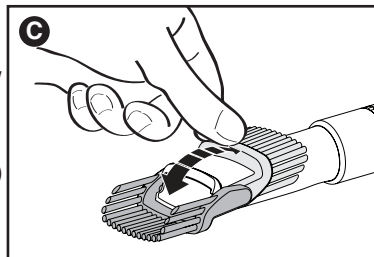
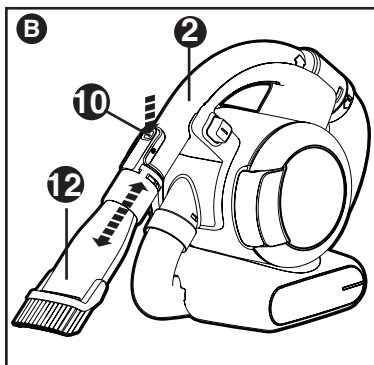

Grab the handle and lift upwards. Unwrap the handle and hose from the main appliance. The hose can extend up to approximately 4 feet (1.21m). To place the handle and hose back onto the main appliance, wrap the hose back underneath and around the vac making sure that the hose fits between the two "feet" of the appliance. Align the handle with its cradle and click back into place. The handle (2) can be removed from the hose allowing the accessories to be connected directly to the hose cuff (20) when desired.

To remove the handle:

- Unclip the handle (2) from the appliance.
- Rotate the locking ring (3) counterclockwise to release the clips.
- Pull the hose away from the handle.
- Fit the accessory directly to the hose cuff (20).

To refit the handle:

- Remove the accessory from the hose.
- Push the hose into the handle (2). Rotate locking ring (3) clockwise until it clicks into place.

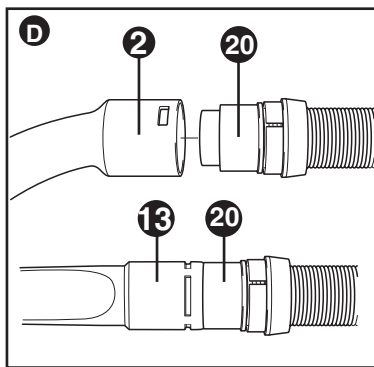

ASSEMBLING FLOOR HEAD (FIGURE E)

(BDH1620FLFH, BDH2020FLFH ONLY)

This vacuum is equipped with a floor head for wider floor cleaning.

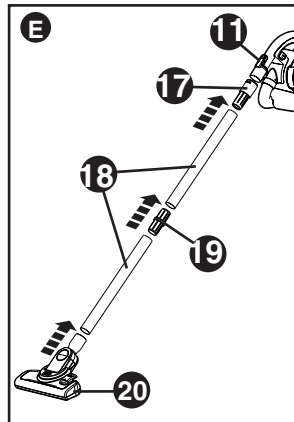

- Press and hold the accessory clip (11).
- Slide the floor head adapter (17) onto the handle (2).
- Connect the two floor head extensions (18), extension connector (19), and the floor head (20) to the end for the floor head adaptor.

NOTE: Ensure that all parts of the floor head assembly are securely connected.



CARPET / FLOORING SELECTOR SWITCH (FIGURE F)

The floor head's agitator brush can be used for light carpet cleaning and removing tough messes on hard floors. It can be activated by depressing the selector switch (21) located on the top of the floor head accessory.

- To engage the agitator brush, depress the side of the selector switch marked .
- To disengage the brush, depress the side of the selector switch marked .

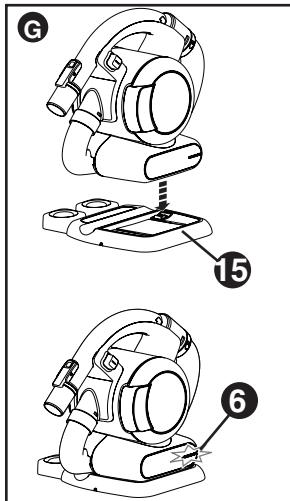
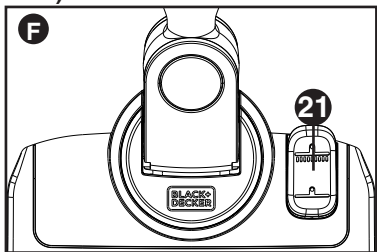

OPERATION

Before first use, the batteries must be charged for at least 4 hours.

- Connect the appliance to the charger for a minimum of 4 hours.
- Charge the batteries as described below.

CHARGING THE BATTERY (FIGURE G)

⚠ WARNING: Charge only at ambient temperatures between 50°F (10°C) and 104°F (40°C). The charger supplied with this product is intended to be plugged in such that it is correctly oriented in floor mount position.

To charge the appliance:

- Make sure the appliance is switched off. The battery will not be charged with the on/off power switch (1) in the on position.
- Plug the charging base (15) into a standard 120 Volt 60 Hz electrical outlet.
- Lower the appliance onto the charging base. The LED (6) in the base of the appliance will blink while charging.
- When charging is complete, the LED will turn off.

While charging, the charger may become warm. This is normal and does not indicate a problem. Leaving the appliance connected to the charger indefinitely will not damage the appliance's batteries or shorten its run time. The charger automatically reduces power consumption when charging is complete.

SWITCHING ON AND OFF (FIGURE H)

- To switch the appliance on, slide the on/off switch (1) to the right until it clicks into the on position.
- To switch the appliance off, slide the on/off switch to the left until it clicks into the off position.

VACUUMING

• When operating the appliance, make sure the hose is not trapped, twisted or blocked.

Two hose positions while vacuuming:

1. You can vacuum with the handle (2) and hose (4) wrapped around the main appliance. Cleaning in this mode is great for quick pick-ups because the vac is in its most compact form.
2. You can vacuum with the handle (2) and hose (4) unwrapped from the main appliance allowing you to reach up to approximately 4 feet (1.2 m) from the appliance.
 - With handle and hose unwrapped the appliance can be carried using the built-in handle on the main appliance.
 - The handle can also be removed from the hose so that you can connect an accessory directly to the hose cuff (17) when desired.

HINTS FOR OPTIMUM USE

- When vacuuming stairs, always start at the bottom and work your way up.
- Use the pet hair cleaning tool to agitate and suction up pet hair and ground-in debris from carpeted or upholstery surfaces.
- In order to keep the suction force optimized, the filters must be cleared regularly during use.

CLEANING AND MAINTENANCE

⚠ WARNING: Do not, under any circumstances, immerse the appliance in water. A damp cloth and soapy water should be used to clean the exterior of the appliance. Always make sure the appliance is completely dry before reuse or storage.

EMPTYING THE DUST CONTAINER (FIGURE I)

The dust container must be emptied regularly, preferably after every use.

- Pull the door latch (8) and open the dust container door (5).
- Tilt appliance to empty dirt.
- Tap the back end of appliance if debris does not fall out easily or remove filters for better access.

CLEANING FILTERS (FIGURES J - L)

Both the plastic pre-filter (22) and the pleated filter (23) are re-usable and should be cleaned regularly.

- Unwrap the hose (4) and handle (2) from the main part of the appliance.
- Pull the door latch (8) and open the dust container door (5) and empty contents into a waste basket.
- Push and hold the release button on the opposite side of the handle from the dust container door (5).
- Rotate the handle toward the back of the appliance as shown in figure J.
- Pull the dust container to the side, away from the base of the appliance.
- Remove the pleated filter from the pre-filter by pulling firmly

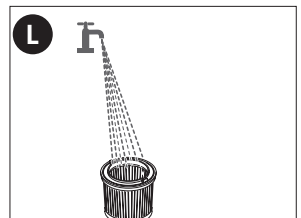
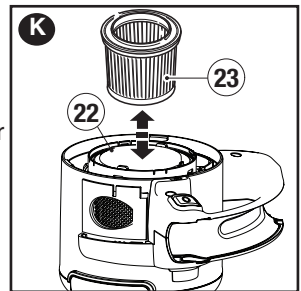
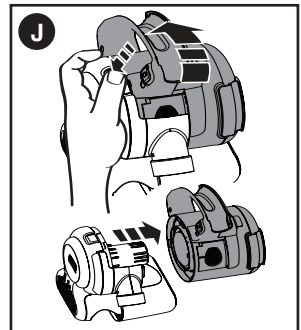
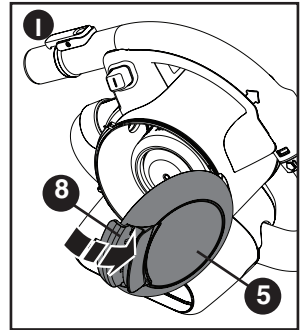

as shown in figure K.

- Tap the filters vigorously to remove loose dust.
- **If necessary, wash the filter (13) in warm, soapy water as shown in figure L.**
- **Make sure that the filter is dry before refitting it to the appliance.**
- Refit the pleated filter into the plastic pre-filter.

TO REPLACE THE DUST CONTAINER

- Slide the container back onto the base and rotate the handle toward the front of the appliance until an audible click is heard. Ensure that the container is fully fastened back onto the base.
- Close the container door and make sure it clicks into place.

CLEANING THE DUST CONTAINER (FIGURE M - N)

- Unwrap the hose (4) and handle (2) from the main part of the appliance.
- Push and hold the release button on the opposite side of the handle from the dust container door (5).
- Rotate the handle toward the back of the appliance as shown in figure M.
- Pull the dust container to the side, away from the base of the appliance.
- Remove the pre-filter (22) and filter (23) from the appliance by twisting the filter to the right and pulling it from the appliance.
- Once filters are removed, wipe the dust container (10) and pre-filter (23) with a damp cloth, or rinse with warm soapy water and allow to dry as shown in figure N.

TO REPLACE THE DUST CONTAINER

- Slide the container back onto the base and rotate the handle toward the front of the appliance until an audible click is heard. Ensure that the container is fully fastened back onto the base.

TROUBLESHOOTING

If the product does not work, check the following:

- The charger was correctly plugged in for recharge.
- The charger cord is not damaged and is correctly attached to the charging base.
- The charger is plugged into a working electrical outlet.
- The appliance was switched to the “off” position to charge. The battery will not be charged with the switch in the “on” position.
- One of the filters may be clogged. Pull the door latch and open the dust container door. Remove the pre-filter and the pleated filter. Brush any loose dust off the filters and wash them in warm, soapy water. Make sure the filters are dry before placing back in the vacuum.

For assistance with your product, visit our website www.blackanddecker.com for the location of the service center nearest you or call the BLACK+DECKER help line at 1-800-544-6986.

BATTERY REMOVAL AND DISPOSAL

This product uses Lithium Ion rechargeable and recyclable batteries. When the batteries no longer hold a charge, they should be removed from the Vac and recycled. They must not be incinerated or composted. The batteries can be taken for disposal to a Black+Decker, Company-Owned or Authorized Service Center. Some local retailers are also participating in a national recycling program (see “RBRC™ Seal”). Call your local retailer for details. If you bring the batteries to a Black+Decker Company-Owned or Authorized Service Center, the Center will arrange to recycle old batteries. Or, contact your local municipality for proper disposal instructions in your city/town.

TO REMOVE THE BATTERY PACK FOR DISPOSAL:

- 1.) Before attempting to disassemble the product, turn it on and leave it on until the motor completely stops, ensuring a complete discharge of the battery.
- 2.) Remove the dust container (10) as described in the “CLEANING THE DUST CONTAINER” section.
- 3.) Invert the appliance to gain access to the screws that attach the base.

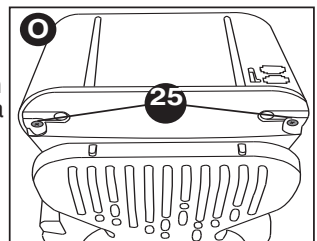
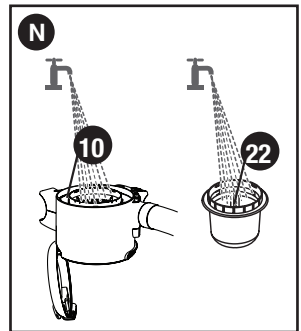
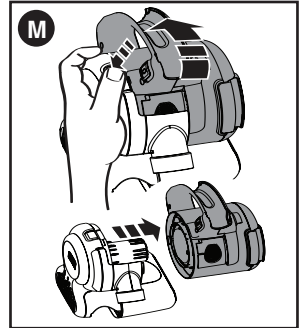

- 4.) Remove the two screws (25) shown in **(figure O)** and lift off the battery housing.
- 5.) Detach all lead connections from the battery pack.
- 6.) Remove battery pack and place in suitable packaging to prevent a short circuit of the battery terminals.
- 7.) Recycle of batteries as per recommended guidelines.

MAINTENANCE

Use only mild soap and damp cloth to clean the vac. Never let any liquid get inside the vac; never immerse the battery/motor housing in liquid.

WARNING: Make sure the vacuum is completely dry before using it.

IMPORTANT: To assure product SAFETY and RELIABILITY, repairs, maintenance and adjustment (other than those listed in this manual) should be performed by authorized service centers or other qualified service organizations, always using identical replacement parts.

THE RBRC™ SEAL

The RBRC™ (Rechargeable Battery Recycling Corporation) Seal on the LI-ION battery (or battery pack) indicates that the costs to recycle the battery (or battery pack) at the end of its useful life have already been paid by **Black+Decker**.

RBRC™ in cooperation with **Black+Decker** and other battery users, has established programs in the United States to facilitate the collection of spent LI-ION batteries. Help protect our environment and conserve natural resources by returning the spent LI-ION battery to an authorized **Black+Decker** service center or to your local retailer for recycling. You may also contact your local recycling center for information on where to drop off the spent battery. RBRC™ is a registered trademark of the *Rechargeable Battery Recycling Corporation*.



SERVICE INFORMATION

All Black+Decker Service Centers are staffed with trained personnel to provide customers with efficient and reliable power tool service. Whether you need technical advice, repair, or genuine factory replacement parts, contact the Black+Decker location nearest you. To find your local service location, call: **1-800-544-6986** or visit www.blackanddecker.com

TWO-YEAR LIMITED HOME USE WARRANTY

Black+Decker (U.S.) Inc. warrants this product for two years against any defects in material or workmanship. The defective product will be replaced or repaired at no charge in either of two ways.

The first, which will result in exchanges only, is to return the product to the retailer from whom it was purchased (provided that the store is a participating retailer). Returns should be made within the time period of the retailer's policy for exchanges (usually 30 to 90 days after the sale). Proof of purchase may be required. Please check with the retailer for their specific return policy regarding returns that are beyond the time set for exchanges.

The second option is to take or send the product (prepaid) to a Black+Decker owned or authorized Service Center for repair or replacement at our option. Proof of purchase may be required.

This warranty does not apply to accessories. This warranty gives you specific legal rights and you may have other rights which vary from state to state or province to province. Should you have any questions, contact the manager of your nearest Black+Decker Service Center. This product is not intended for commercial use.

FREE WARNING LABEL REPLACEMENT: If your warning labels become illegible or are missing, call **1-800-544-6986** for a free replacement.

LATIN AMERICA: This warranty does not apply to products sold in Latin America. For products sold in Latin America, check country specific warranty information contained in the packaging, call the local company or see the website for warranty information.

Imported by
Black & Decker (U.S.) Inc.,
701 E. Joppa Rd.
Towson, MD 21286 U.S.A.

