

23816-015



- Stainless steel ring
AISI 316 - CD Range
- Half frosted tempered glass
- 3 feet of silicone wire included
- Polypropilene housing for recess included
- Ready to be installed



5 YEAR WARRANTY

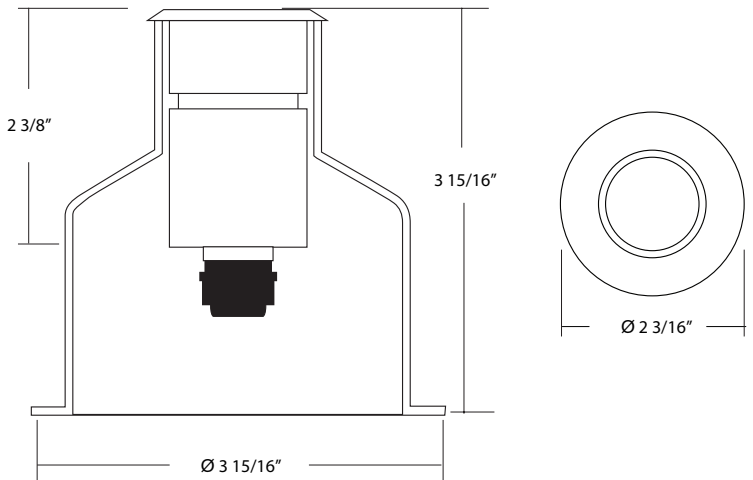

3 x 1 WATT CREE SUPER LED
 3000 KELVINS
 DRIVER NOT INCLUDED 350mA 12V
 IP67



SPOT 25°



NEW "CD" RING

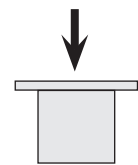

MAX 5.000 kg

