

American Standard

HERITAGE

SINGLE HANDLE PANTRY/BAR SINK FAUCET WITH BRASS GOOSENECK SPOUT



7100.271H Shown.

MODEL NUMBER:

- 7100.241H Pantry/Bar Sink Faucet
Metal Lever handle.
- 7100.251H Pantry/Bar Sink Faucet
Metal Cross handle.
- 7100.271H Pantry/Bar Sink Faucet
Brass Wrist Blade handle.

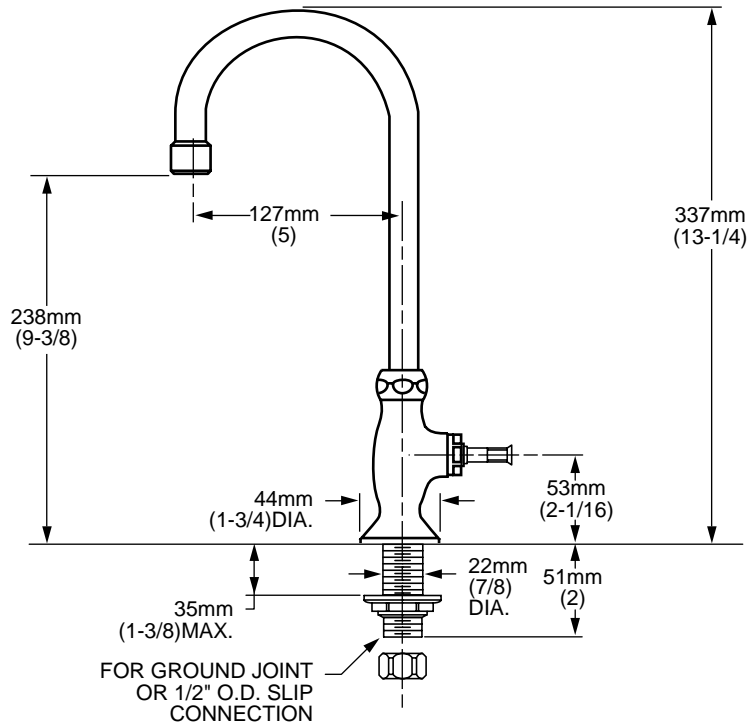
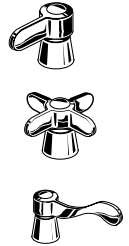

GENERAL DESCRIPTION:

Durable brass construction. Amaris 1/4 turn washerless ceramic disc valve cartridge. One-half inch male inlet shank with brass coupling nut and shank nut. Choice of wrist blade, lever or cross handle. Brass gooseneck swing spout. 2.2gpm/8.3L/min. maximum flow rate. For cold or tempered water.

PRODUCT FEATURES:

Brass Construction: Durable - Excellent in high use applications. Ideal for prolonged contact with water.

Ceramic Disc Valve Cartridge: Assures a lifetime of drip-free performance.

Low Lead: Meets NSF Standard 61/Section 9 & Prop 65 lead requirements.

SUGGESTED SPECIFICATION:

Single handle pantry/bar sink faucet shall feature cast brass construction. Shall feature all brass shank nut and coupling nut. Shall also feature 1/4 turn washerless ceramic disc valve cartridge. Fitting shall be American Standard Model # 7100.____.____.





SINGLE HANDLE PANTRY/BAR SINK FAUCET WITH BRASS GOOSENECK SPOUT

CODES AND STANDARDS

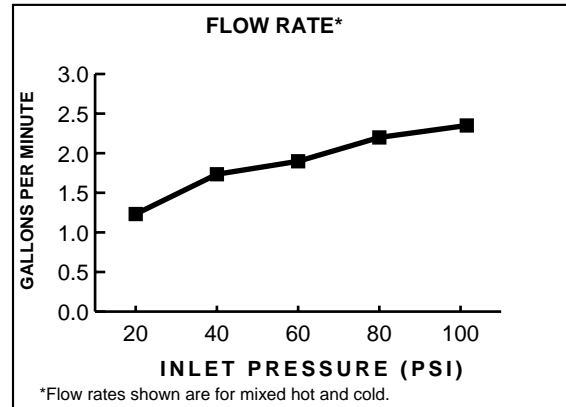
These products meet or exceed the following codes and standards:

ASME A112.18.1M
CSA B 125
NSF 61/Section 9



		Product Number	Description	Finish	
				Polished Chrome	PVD Satin
				002	295
		7100.241H	Pantry/Bar faucet. Metal Lever handle.		
		7100.251H	Pantry/Bar faucet. Metal Cross handle.		
		7100.271H	Pantry/Bar faucet. Brass Wrist Blade handle.		

 Meets the American Disabilities Act Guidelines and **ANSI A117.1** Requirements for the physically challenged.