

# Installation Instructions and Use & Care Guide

## ULTRA LOW NOX RESIDENTIAL GAS WATER HEATERS



NOT FOR USE IN MANUFACTURED (MOBILE) HOMES



**WARNING:** If the information in these instructions is not followed exactly, a fire or explosion may result causing property damage, personal injury or death.

- Do not store or use gasoline or other flammable vapors and liquids in the vicinity of this or any other appliance.
- WHAT TO DO IF YOU SMELL GAS:
  - Do not try to light any appliance.
  - Do not touch any electrical switch; do not use any phone in your building.
  - Immediately call your gas supplier from a neighbor's phone. Follow the gas supplier's instructions.
  - If you cannot reach your gas supplier, call the fire department.
- Installation and service must be performed by a qualified installer, service agency or the gas supplier.

	<b>⚠ WARNING</b>
	<p>Read and understand instruction manual and safety messages before installing, operating or servicing this water heater.</p> <p>Failure to follow instructions and safety messages could result in death or serious injury.</p> <p>Instruction manual must remain with water heater.</p>

**• For Your Safety •**  
AN ODORANT IS ADDED TO THE GAS USED BY THIS WATER HEATER.

**DO NOT RETURN THIS UNIT TO THE STORE.** To obtain technical, warranty, or service assistance during or after the installation of this water heater, visit our website at: [http:// www.AOSmithAtLowes.com](http://www.AOSmithAtLowes.com) or call toll free 1-877-817-6750.

**KEEP THIS MANUAL IN THE POCKET ON HEATER FOR FUTURE REFERENCE  
WHENEVER MAINTENANCE ADJUSTMENT OR SERVICE IS REQUIRED.**





# TABLE OF CONTENTS

SAFE INSTALLATION, USE AND SERVICE.....	3	Fresh Air Openings For Confined Spaces .....	13
GENERAL SAFETY INFORMATION.....	4	Outdoor Air Through Two Openings .....	13
Abbreviations Used.....	5	Outdoor Air Through Two Horizontal Ducts .....	14
Qualified Installer or Service Agency.....	5	Outdoor Air Through Two Vertical Ducts.....	14
Preparing For The Installation .....	5	Air From Other Indoor Spaces.....	14
INTRODUCTION .....	5	Venting.....	14
INSTALLATION CONSIDERATIONS .....	6	Gas Piping .....	16
Thermometers (Not Supplied) .....	7	Sediment Traps.....	17
Facts to Consider About the Location.....	7	TEMPERATURE REGULATION .....	19
High Altitude.....	8	Start Up Conditions.....	19
Clearances.....	8	Operational Conditions .....	20
Insulation Blankets.....	9	Venting System Inspection .....	21
Hard Water .....	9	Burner Inspection.....	21
Circulation Pumps.....	9	Burner Cleaning.....	21
Gas Supply Systems .....	10	Housekeeping.....	21
Gas Pressure Requirements .....	10	PERIODIC MAINTENANCE .....	21
Supply Gas Regulator.....	10	Anode Rod Inspection .....	22
Mixing Valves.....	10	Temperature-Pressure Relief Valve Test .....	22
INSTALLATION REQUIREMENTS .....	10	Draining And Flushing.....	23
Water Piping .....	11	Service.....	23
Closed Water Systems .....	11	REPLACING PARTS .....	24
Thermal Expansion.....	11	Replacement Parts .....	24
Temperature-Pressure Relief Valve .....	11	LEAKAGE CHECKPOINTS.....	27
Filling the Water Heater .....	12	REPAIR PARTS.....	28
Air Requirements.....	12	TROUBLESHOOTING GUIDELINES.....	29
Unconfined Space .....	13	NOTES .....	30
Confined Space .....	13		

# SAFE INSTALLATION, USE AND SERVICE

The proper installation, use and servicing of this water heater is extremely important to your safety and the safety of others. Many safety-related messages and instructions have been provided in this manual and on your own water heater to warn you and others of a potential injury hazard. Read and obey all safety messages and instructions throughout this manual. It is very important that the meaning of each safety message is understood by you and others who install, use, or service this water heater.

	<p>This is the safety alert symbol. It is used to alert you to potential personal injury hazards. Obey all safety messages that follow this symbol to avoid possible injury or death.</p>
---	---

	<p>DANGER indicates an imminently hazardous situation which, if not avoided, will result in injury or death.</p>
	<p>WARNING indicates a potentially hazardous situation which, if not avoided, could result in injury or death.</p>
	<p>CAUTION indicates a potentially hazardous situation which, if not avoided, could result in minor or moderate injury.</p>
	<p>CAUTION used without the safety alert symbol indicates a potentially hazardous situation which, if not avoided, could result in property damage.</p>

All safety messages will generally tell you about the type of hazard, what can happen if you do not follow the safety message, and how to avoid the risk of injury.

## APPROVALS



Low Lead Content

GAS-FIRED



LISTED

# GENERAL SAFETY INFORMATION



**⚠ WARNING**

Read and understand instruction manual and safety messages before installing, operating or servicing this water heater.

Failure to follow instructions and safety messages could result in death or serious injury.

Instruction manual must remain with water heater.



**⚠ WARNING**

**Fire Hazard**

For continued protection against risk of fire:

- Do not install water heater on carpeted floor.
- Do not operate water heater if any part has been exposed to flooding or water damage.

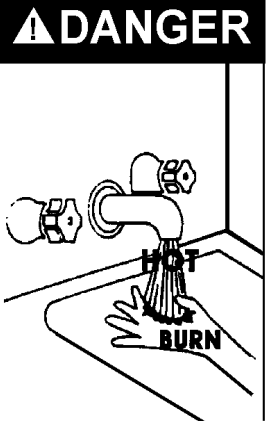

**⚠ DANGER**

Water temperature over 125°F (52°C) can cause severe burns instantly resulting in severe injury or death.

Children, the elderly, and the physically or mentally disabled are at highest risk for scald injury.

Feel water before bathing or showering.

Temperature limiting valves are available.

Read instruction manual for safe temperature setting.

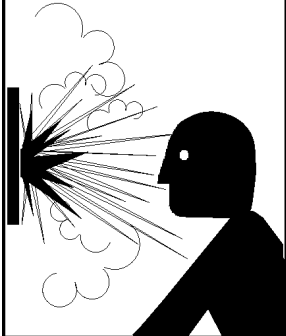

**⚠ WARNING**

**Explosion Hazard**

- Overheated water can cause watertank explosion.
- Properly sized temperature and pressure relief valve must be installed in opening provided.

**⚠ WARNING**

**Fire or Explosion Hazard**

- Avoid all ignition sources if you smell gas.
- Do not expose water heater control to excessive gas pressure.
- Use only gas shown on rating plate.
- Maintain required clearances to combustibles.
- Keep ignition sources away from faucets after extended period of non-use.

Read instruction manual before installing, using or servicing water heater.

**⚠ WARNING**

**Breathing Hazard - Carbon Monoxide Gas**

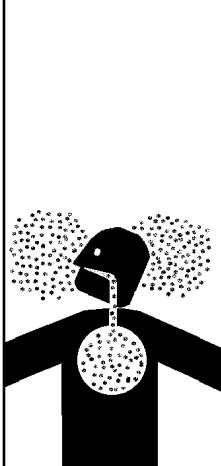

- Install vent system in accordance with codes.
- Do not operate water heater if any part has been exposed to flooding or water damage.
- High altitude orifice must be installed if a standard model is installed above 7,700 ft. (2,347 m).
- Do not operate if soot buildup.
- Do not obstruct water heater air intake with insulating jacket.
- Do not place chemical vapor emitting products near water heater.
- Gas and carbon monoxide detectors are available.

Breathing carbon monoxide can cause brain damage or death. Always read and understand instruction manual.

**⚠ DANGER**

**Fire or Explosion Hazard**

- Do not store or use gasoline or other flammable vapors and liquids in the vicinity of this or any other appliance.

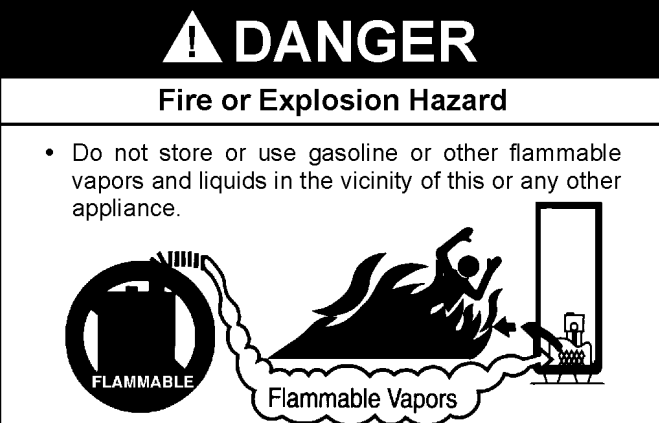

Flammable Vapors

**CAUTION**

**Improper installation and use may result in property damage.**

- Do not operate water heater if any part has been exposed to flooding or water damage.
- Inspect and replace anode rod as needed.
- Install in location with drainage.
- Fill tank with water before operation.
- Be alert for thermal expansion.

Refer to instruction manual for installation and service.

# INTRODUCTION

Thank You for purchasing this water heater. Properly installed and maintained, it should give you years of trouble free service.

## ABBREVIATIONS USED

Abbreviations Found In This Instruction Manual:

- UL - Underwriters Laboratories Inc.
- ANSI - American National Standards Institute
- NFPA - National Fire Protection Association
- ASME - American Society of Mechanical Engineers
- AHRI - Air-Conditioning, Heating and Refrigeration Institute
- EPACT - Energy Policy Act
- CSA - Canadian Standards Association

This gas-fired water heater is design certified by Underwriters Laboratories Inc. under American National Standard/CSA Standard for Gas Water Heaters ANSI Z21.10.3 • CSA 4.3 (current edition).

## QUALIFIED INSTALLER OR SERVICE AGENCY

Installation and service of this water heater requires ability equivalent to that of a Qualified Agency (as defined by ANSI below) in the field involved. Installation skills such as plumbing, air supply, venting, gas supply and electrical supply are required in addition to electrical testing skills when performing service.

ANSI Z223.1 2006 Sec. 3.3.83: "Qualified Agency" - "Any individual, firm, corporation or company that either in person or through a representative is engaged in and is responsible for (a) the installation, testing or replacement of gas piping or (b) the connection, installation, testing, repair or servicing of appliances and equipment; that is experienced in such work; that is familiar with all precautions required; and that has complied with all the requirements of the authority having jurisdiction."

If you are not qualified (as defined by ANSI above) and licensed or certified as required by the authority having jurisdiction to perform a given task do not attempt to perform any of the procedures described in this manual. If you do not understand the instructions given in this manual do not attempt to perform any procedures outlined in this manual.

## PREPARING FOR THE INSTALLATION

1. Read the General Safety Information section, page 4 of this manual first and then the entire manual carefully. If you don't follow the safety rules, the water heater will not operate

properly. It could cause DEATH, SERIOUS BODILY INJURY AND/OR PROPERTY DAMAGE.

This manual contains instructions for the installation, operation, and maintenance of the gas-fired water heater. It also contains warnings throughout the manual that you must read and be aware of. All warnings and all instructions are essential to the proper operation of the water heater and your safety. Since we cannot put everything on the first few pages, **READ THE ENTIRE MANUAL BEFORE ATTEMPTING TO INSTALL OR OPERATE THE WATER HEATER.**

2. The installation must conform with these instructions and the local code authority having jurisdiction. In the absence of local codes, the installation must comply with the current edition of the National Fuel Gas Code, ANSI Z223.1/NFPA 54. All documents are available from the Canadian Standards Association, 8501 East Pleasant Valley Road, Cleveland, OH 44131. NFPA documents are also available from the National Fire Protection Association, 1 Batterymarch Park, Quincy, MA 02269.
3. If after reading this manual you have any questions or do not understand any portion of the instructions, call the local gas utility or the manufacturer whose name appears on the rating plate.
4. Carefully plan the place where you are going to put the water heater. Correct combustion, vent action, and vent pipe installation are very important in preventing death from possible carbon monoxide poisoning and fires, see Figures 3 and 7.  
  
Examine the location to ensure the water heater complies with the Fact to Consider About The Location section in this manual.
5. For California installation this water heater must be braced, anchored, or strapped to avoid falling or moving during an earthquake. See instructions for correct installation procedures. Instructions may be obtained from California Office of the State Architect, 400 P Street, Sacramento, CA 95814.
6. Massachusetts Code requires this water heater to be installed in accordance with Massachusetts 248-CMR 2.00: State Plumbing Code and 248-CMR 5.00.
7. Complies with SCAQMD rule #1146.2 and districts having equivalent NOx requirements.

# INSTALLATION CONSIDERATIONS

## GET TO KNOW YOUR WATER HEATER - GAS MODELS

- |                             |                              |                                     |
|-----------------------------|------------------------------|-------------------------------------|
| A Vent Pipe                 | I Ground Joint Union         | Q Temperature-Pressure Relief Valve |
| B Draft Hood                | J Sediment Trap              | R Rating Plate                      |
| C Anode                     | K Inner Door                 | S Flue Baffle(s)                    |
| D Hot Water Outlet          | L Outer door                 | T Gas Control Valve/Thermostat      |
| E Outlet                    | M Union                      | U Drain Valve                       |
| F Insulation                | N Inlet Water Shut-off Valve | V Pilot and Main Burner             |
| G Gas Supply                | O Cold Water Inlet           | W Flue                              |
| H Manual Gas Shut-off Valve | P Inlet Dip Tube             | X Metal Drain Pan                   |

\* INSTALL IN ACCORDANCE WITH LOCAL CODES.

\* SEDIMENT TRAP AS REQUIRED BY LOCAL CODES.

\* ALL PIPING MATERIALS TO BE SUPPLIED BY CUSTOMERS.

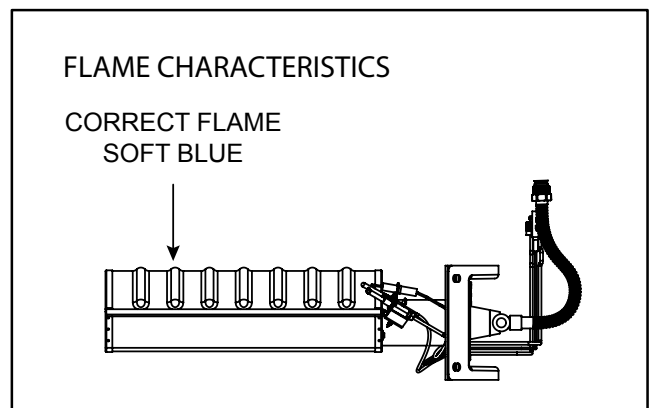
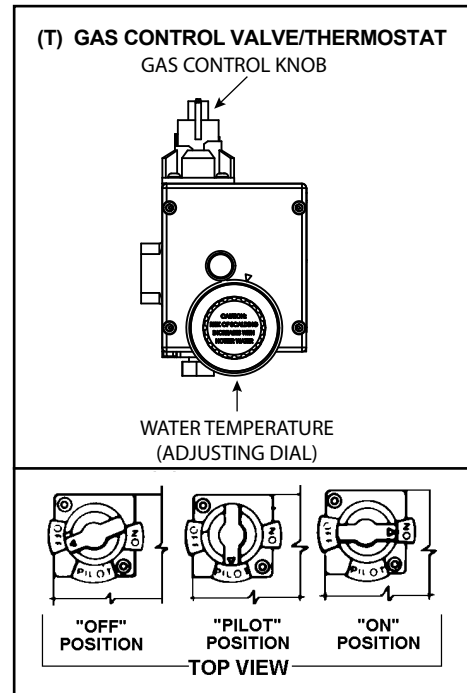
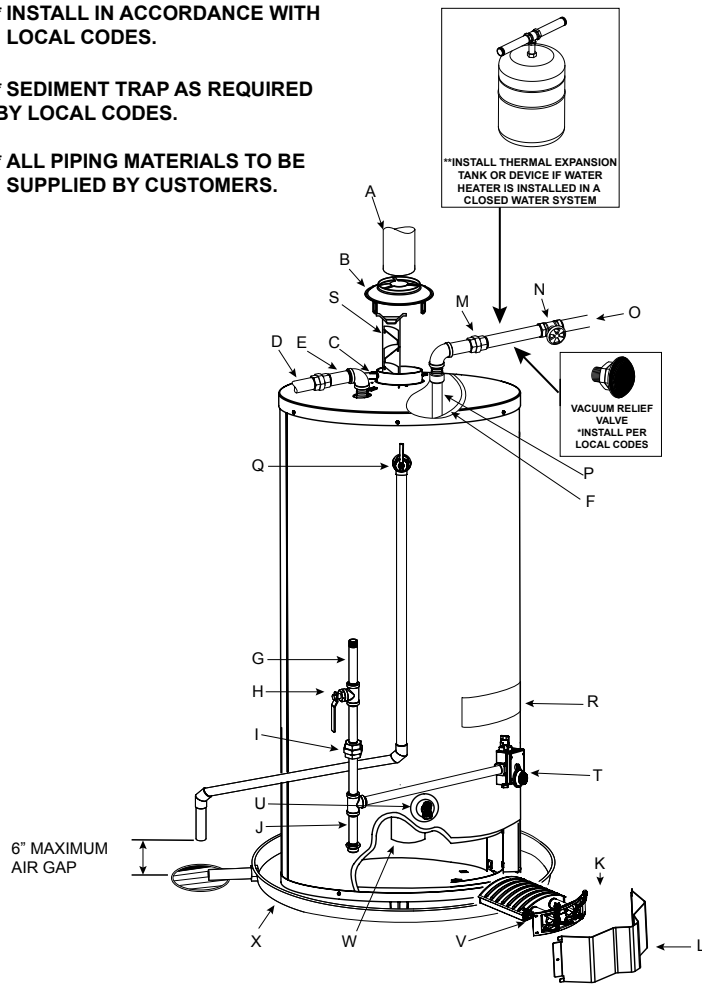

\*\*CLOSED WATER SYSTEMS ARE THOSE WITH BACK FLOW PREVENTION DEVICES INSTALLED IN THE WATER SERVICE LINE.

FIGURE 1.

## THERMOMETERS (NOT SUPPLIED)

Thermometers should be obtained and field installed.

Thermometers are installed in the system as a means of detecting the temperature of the outlet water supply.

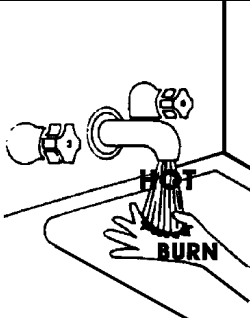
	<p><b>⚠ DANGER</b> Water temperature over 125°F (52°C) can cause severe burns instantly resulting in severe injury or death.</p> <p>Children, the elderly, and the physically or mentally disabled are at highest risk for scald injury.</p> <p>Feel water before bathing or showering.</p> <p>Temperature limiting valves are available.</p> <p>Read instruction manual for safe temperature setting.</p>
---	--

This Water Heater has been design certified as complying with ANSI Z21.10.3-CSA 4.3 current edition for water heaters and is considered suitable for:

Water (Potable) Heating and Space Heating: All models are considered suitable for water (potable) heating and space heating.

**HOTTER WATER CAN SCALD:**

Water heaters are intended to produce hot water. Water heated to a temperature which will satisfy space heating, clothes washing, dish washing, and other sanitizing needs can scald and permanently injure you upon contact. Some people are more likely to be permanently injured by hot water than others. These include the elderly, children, the infirm, or physically/mentally handicapped. If anyone using hot water in your home fits into one of these groups or if there is a local code requiring a certain temperature water at the hot water tap, then you must take special precautions. In addition to using the lowest possible temperature setting that satisfies your hot water needs, a means such as a \*Mixing Valve should be used at the hot water taps used by these people or at the water heater. Mixing valves are available at plumbing supply or hardware stores. Consult a qualified installer or service technician. Follow mixing valve manufacturer's instructions for installation of valves. Before changing the factory setting on the thermostat, read the "Temperature Regulation" section in this manual, see Figures 17 and 18.

## FACTS TO CONSIDER ABOUT THE LOCATION

Carefully choose an indoor location for the new water heater, because the placement is a very important consideration for the safety of the occupants in the building and for the most economical use of the water heater. This water heater is not for use in manufactured (mobile) homes or outdoor installation.

Whether replacing an old water heater or putting the water heater in a new location, the following critical points must be observed:

1. Select a location indoors as close as practical to the gas vent or chimney to which the water heater vent is going to be connected, and as centralized with the water piping system as possible.
2. Selected location must provide adequate clearances for servicing and proper operation of the water heater.

## CAUTION

### Property Damage Hazard

- All water heaters eventually leak
- Do not install without adequate drainage.

Installation of water heater must be accomplished in such a manner that if the tank or any connections should leak, flow will not cause damage to

the structure. For this reason, it is not advisable to install water heater in an attic or upper floor. When such locations cannot be avoided, a suitable metal drain pan should be installed under the water heater. Metal Drain pans are available at your local hardware store. Such a metal drain pan must have a minimum length and width of at least 2" (51 mm) greater than water heater dimensions and must be piped to an adequate drain. The pan must not restrict combustion air flow.

Water heater life depends upon water quality, water pressure and the environment in which the water heater is installed. Water heaters are sometimes installed in locations where leakage may result in property damage, even with the use of a drain pan piped to a drain. However, unanticipated damage can be reduced or prevented by a leak detector or water shut-off device used in conjunction with a piped drain pan. These devices are available from some plumbing supply wholesalers and retailers, and detect and react to leakage in various ways:

- Sensors mounted in the drain pan that trigger an alarm or turn off the incoming water to the water heater when leakage is detected.
- Sensors mounted in the drain pan that turn off the water supply to the entire home when water is detected in the drain pan.
- Water supply shut-off devices that activate based on the water pressure differential between the cold water and hot water pipes connected to the water heater.
- Devices that will turn off the gas supply to a gas water heater while at the same time shutting off its water supply.

## ⚠ WARNING

### Fire or Explosion Hazard

- Avoid all ignition sources if you smell gas.
- Do not expose water heater control to excessive gas pressure.
- Use only gas shown on rating plate.
- Maintain required clearances to combustibles.
- Keep ignition sources away from faucets after extended period of non-use.



Read instruction manual before installing, using or servicing water heater.



## ⚠ DANGER

### Fire or Explosion Hazard

- Do not store or use gasoline or other flammable vapors and liquids in the vicinity of this or any other appliance.



INSTALLATIONS IN AREAS WHERE FLAMMABLE LIQUIDS (VAPORS) ARE LIKELY TO BE PRESENT OR STORED (GARAGES, STORAGE AND UTILITY AREAS, ETC.): Flammable liquids (such as gasoline, solvents, propane [LP or butane, etc.] and other substances such as adhesives, etc.) emit flammable vapors which can be ignited by a gas water heater's pilot light or main burner. The resulting flashback and fire can cause death or serious burns to anyone in the area, as well as property damage. If installation in such areas is your only option, then installation must be accomplished in a way that the pilot flame and main burner flame are elevated from floor at least 18 inches. While this may reduce chances of flammable vapors, from a floor spill being ignited, gasoline and other flammable substances should never be stored or

used in the same room or area containing a gas water heater or other open flame or spark producing appliance. NOTE: Flammable vapors may be drawn by air currents from other areas of the structure to the appliance.

Also, the water heater must be located and/or protected so it is not subject to physical damage by a moving vehicle.

	<h2>! WARNING</h2> <h3>Fire Hazard</h3>
	<p>For continued protection against risk of fire:</p> <ul style="list-style-type: none"> <li>• Do not install water heater on carpeted floor.</li> <li>• Do not operate water heater if any part has been exposed to flooding or water damage.</li> </ul>

This water heater must not be installed directly on carpeting. Carpeting must be protected by metal or wood panel beneath the water heater extending beyond the full width and depth of the water heater by at least 3" (76.2 mm) in any direction, or if the water heater is installed in an alcove or closet, the entire floor must be covered by the panel. Failure to heed this warning may result in a fire hazard.

### High Altitude

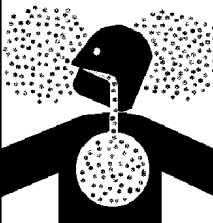
<h2>! WARNING</h2> <h3>Breathing Hazard - Carbon Monoxide Gas</h3>	
	<ul style="list-style-type: none"> <li>• High altitude orifice must be installed if a standard model is installed above 7,700 feet (2347m).</li> <li>• Contact your local supplier.</li> </ul>
	<p>Breathing carbon monoxide can cause brain damage or death. Always read and understand instruction manual.</p>

Water heaters covered in this manual have been tested and approved for installation at elevations up to 7,700 feet (2,347 m) above sea level. For installation above 7,700 feet (2,347 m), the water heater's Btu input should be reduced at the rate of 4 percent for each 1,000 feet (305 m) above sea level which requires replacement of the burner orifice in accordance with the National Fuel Gas Code ANSI Z223.1/NFPA 54. Contact your local gas supplier for further information.

Failure to replace the standard orifice with the proper high altitude orifice when installed at elevations above 7,700 feet (2,347 m) could result in improper and inefficient operation of the water heater, producing carbon monoxide gas in excess of the safe limits. This could result in serious injury or death. Contact your local gas supplier for any specific changes that may be required in your area.

<h2>! WARNING</h2> <h3>Fire or Explosion Hazard</h3>	
<p>Read instruction manual before installing, using or servicing water heater.</p>	
 <ul style="list-style-type: none"> <li>• Improper use may result in fire or explosion.</li> <li>• Maintain required clearances to combustibles.</li> </ul>	

### CLEARANCES

Minimum clearances between the water heater and combustible construction are 0 inch at the sides and rear, 4" (102 mm) for 100 gallon unit and 5" (127 mm) for 75 gallon unit at the front, and 6" (153 mm) from the vent pipe. Clearance from the top of the jacket is 12" (305 mm).

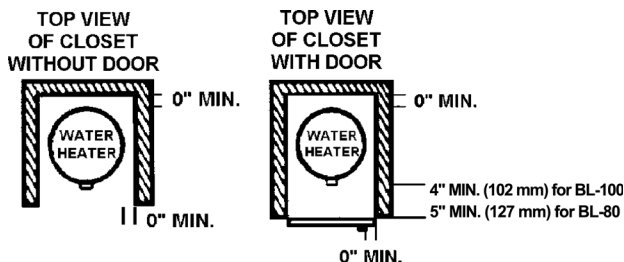
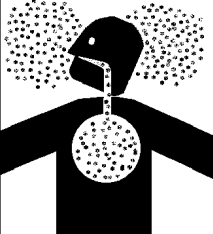

FIGURE 2.

<h2>! WARNING</h2> <h3>Breathing Hazard - Carbon Monoxide Gas</h3>	
	<ul style="list-style-type: none"> <li>• Install water heater in accordance with the instruction manual and NFPA54.</li> <li>• To avoid injury, combustion and ventilation air must be taken from outdoors.</li> <li>• Do not place chemical vapor emitting products near water heater.</li> </ul>
	<p>Breathing carbon monoxide can cause brain damage or death. Always read and understand instruction manual.</p>

A gas water heater cannot operate properly without the correct amount of air for combustion. Do not install in a confined area such as a closet, unless you provide air as shown in the Facts to Consider About The Location section. Never obstruct the flow of ventilation air. If you have any doubts or questions at all, call your gas supplier. Failure to provide the proper amount of combustion air can result in a fire or explosion and cause death, serious bodily injury, or property damage.

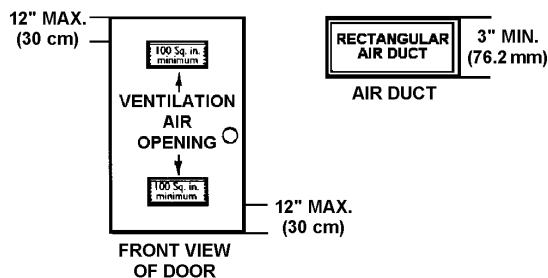

FIGURE 3.

If this water heater will be used in beauty shops, barber shops, cleaning establishments, or self-service laundries with dry cleaning equipment, it is imperative that the water heater or water heaters be installed so that combustion and ventilation air be taken from outside these areas.

Propellants of aerosol sprays and volatile compounds, (cleaners, chlorine based chemicals, refrigerants, etc.) in addition to being highly flammable in many cases, will also change to corrosive hydrochloric acid when exposed to the combustion products of the water heater. The results can be hazardous, and also cause product failure.



## INSULATION BLANKETS

# ⚠ WARNING

## Breathing Hazard - Carbon Monoxide Gas



- Do not obstruct water heater air intake with insulating blanket.
- Gas and carbon monoxide detectors are available.
- Install water heater in accordance with the instruction manual.

Breathing carbon monoxide can cause brain damage or death. Always read and understand instruction manual.

Insulation blankets are available to the general public for external use on gas water heaters but are not necessary with these products. The purpose of an insulation blanket is to reduce the standby heat loss encountered with storage tank heaters. The water heaters covered by this manual meet or exceed the Energy Policy Act standards with respect to insulation and standby heat loss requirements, making an insulation blanket unnecessary.

Should you choose to apply an insulation blanket to this heater, you should follow these instructions. See the Installation Considerations section of this manual for identification of components mentioned below. Failure to follow these instructions can restrict the air flow required for proper combustion, potentially resulting in fire, asphyxiation, serious personal injury or death.

- DO NOT** apply insulation to the top of the water heater, as this will interfere with safe operation of the draft hood.
- DO NOT** cover the thermostat or the Temperature-Pressure Relief Valve.
- DO NOT** allow the insulation to come within 2 inches (5 cm) of the floor to prevent blockage of combustion air flow to the burner.
- DO NOT** cover the instruction manual. Keep it on the side of the water heater or nearby for future reference.
- DO** obtain new warning and instruction labels from the manufacturer for placement on the blanket directly over the existing labels.
- DO** inspect the insulation blanket frequently to make certain it does not sag, thereby obstructing the combustion air flow.

## HARD WATER

Where hard water conditions exist, water softening or the threshold type of water treatment is recommended. This will protect the dishwashers, coffee urns, water heaters, water piping and other equipment. See the Maintenance Section in this manual for sediment and lime scale removal procedures.

## CIRCULATION PUMPS

A circulating pump is used when a system requires a circulating loop or there is a storage tank used in conjunction with the water heater. See Water Piping Diagrams in this manual for installation location of circulating pumps.

See the Circulation Pump Wiring Diagrams below for electrical hookup information. Install in accordance with the current edition of the National Electrical Code, NFPA 70.

All bronze or stainless steel circulating pumps are recommended for used with commercial water heaters.

Some circulating pumps are manufactured with sealed bearings and do not require further lubrication. Some circulating pumps must be periodically oiled. Refer to the pump manufacturer's instructions for lubrication requirements.

CIRCULATING PUMP WIRING DIAGRAM  
STORAGE TANK OR BUILDING RECIRCULATION

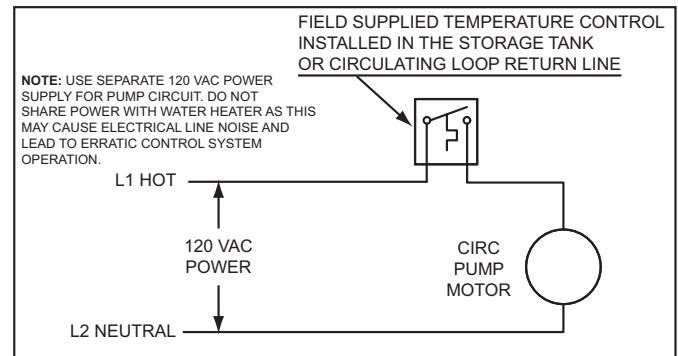

FIGURE 4.

CIRCULATING PUMP WIRING DIAGRAM  
DISHWASHER LOOP WITH TOGGLE SWITCH

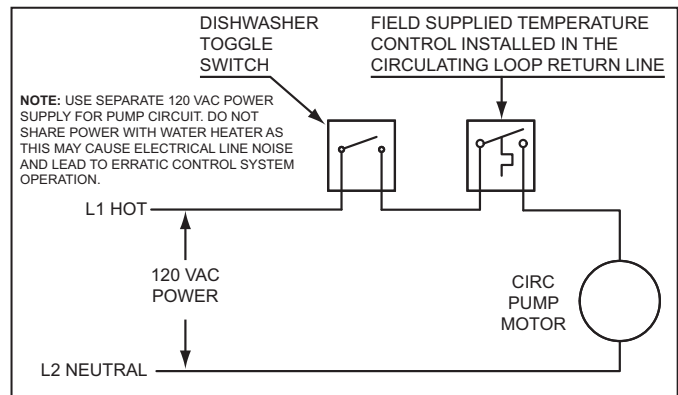

FIGURE 5.

# INSTALLATION REQUIREMENTS

## GAS SUPPLY SYSTEMS

Low pressure building gas supply systems are defined as those systems that cannot under any circumstances exceed 14" W.C. (1/2 PSI Gauge). These systems do not require pressure regulation. Measurements should be taken to insure that gas pressures are stable and fall within the requirements stated on the water heater rating plate. readings should be taken with all gas burning equipment off (static pressure) and with all gas burning equipment running at maximum rate (dynamic pressure). The gas supply pressure must be stable within 1.5" W.C. from static to dynamic pressure to provide good performance. Pressure drops that exceed 1.5" W.C. may cause rough starting, noisy combustion or nuisance outages. Increases or spikes in static pressure during off cycles may cause failure to ignite or in severe cases damage to appliance gas valves. If your low pressure system does not meet these requirements, the installer is responsible for the corrections.

High Pressure building supply systems use pressures that exceed 14" W.C. (1/2 PSI Gauge). These systems must use field supplied regulators to lower the gas pressure to less than 14" W.C. (1/2 PSI Gauge). Appliances require gas regulators that are properly sized for the water heater input and deliver the rating plate specified pressures. Gas supply systems where pressure exceeds 5 PSI often require multiple regulators to achieve desired pressures. Systems in excess of 5 PSI building pressure should be designed by gas delivery professionals for best performance. Water heaters connected to gas supply systems that exceed 14" W.C. (1/2 PSI Gauge) at any time must be equipped with a gas supply regulator.

## GAS PRESSURE REQUIREMENTS

100 gallon natural gas model requires a minimum gas supply pressure of 5" w.c. (1.25 kPa); 75 gallon natural gas model requires a minimum gas supply pressure of 6" w.c. (1.49 kPa). The minimum supply pressure is measured while gas is flowing (dynamic pressure). The supply pressure (dynamic) should never fall below the specified minimum supply pressure. The supply pressure should be measured with all gas fired appliances connected to the common main firing at full capacity. If the supply pressure drops more than 1.5" W.C. (0.37 kPa) as gas begins to flow to the water heater then the supply gas system including the gas line and/or the gas regulator may be restricted or undersized. See Supply Gas regulator section and Gas Piping section of this manual. The gas valve on all models has a maximum gas supply pressure limit of 14" W.C. (3.48 kPa) The maximum supply pressure is measured while gas is not flowing (static pressure).

## SUPPLY GAS REGULATOR

The maximum allowable gas supply pressure for this water heater is 14.0 inches W.C. (3.48 kPa). Install a positive lock-up gas pressure regulator in the gas supply line if inlet gas pressure can exceed 14.0 inches W.C. (3.48 kPa) at any time. regulators must be sized/used according to manufacturer's specifications.

If a positive lock-up regulator is required follow these instructions:

1. Positive lock-up gas pressure regulators must be rated at or above the input Btu/hr rating of the water heater they supply.
2. Positive lock-up gas pressure regulator(s) should be installed no closer than 3 feet (1 meter) and no farther than 8 feet (2.4 meters) of equivalent length from the water heater's inlet gas connection.
3. After installing the positive lock-up gas pressure regulator(s) an initial nominal supply pressure setting of 7.0" W.C. while the water heater is operating is recommended and will generally provide good water heater operation. Some additional adjustment maybe required later to maintain a steady gas supply pressure.
4. When installing multiple water heaters in the same gas supply system it is recommended that individual positive lock-up gas pressure regulators be installed at each unit.

## MIXING VALVES

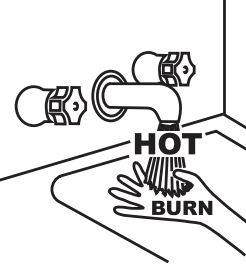

**⚠ DANGER** Water temperature over 125°F (52°C) can cause severe burns instantly resulting in severe injury or death.

Children, the elderly and the physically or mentally disabled are at highest risk for scald injury.

Feel water before bathing or showering.

Temperature limiting devices such as mixing valves must be installed when required by codes and to ensure safe temperatures at fixtures.

Water heated to a temperature which will satisfy clothes washing, dish washing, and other sanitizing needs can scald and cause permanent injury upon contact. Short repeated heating cycles caused by small hot water uses can cause temperatures at the point of use to exceed the water heater's temperature setting by up to 20°F (11°C).

Some people are more likely to be permanently injured by hot water than others. These include the elderly, children, the infirm and the physically/mentally disabled. Table 2 shows the approximate time-to-burn relationship for normal adult skin. If anyone using hot water provided by the water heater being installed fits into one of these groups or if there is a local code or state law requiring a certain water temperature at the point of use, then special precautions must be taken.

In addition to using the lowest possible temperature setting that satisfies demand of the application a Mixing Valve should be installed at the water heater or at hot water taps to further reduce system water temperature. See Figure 6.

Mixing valves are available at plumbing supply stores. Consult a Qualified Installer or Service Technician. Follow mixing valve manufacturer's instructions for installation of the valves.

TABLE 2.

Water Temperature °F	Time for 1st Degree Burn (Less Severe Burns)	Time for Permanent Burns 2nd & 3rd Degree (Most Severe Burns)
110	(normal shower temp.)	
116	(pain threshold)	
116	35 minutes	45 minutes
122	1 minute	5 minutes
131	5 seconds	25 seconds
140	2 seconds	5 seconds
149	1 second	2 seconds
154	instantaneous	1 second

(U.S. Government Memorandum, C.P.S.C., Peter L. Armstrong, Sept. 15, 1978)

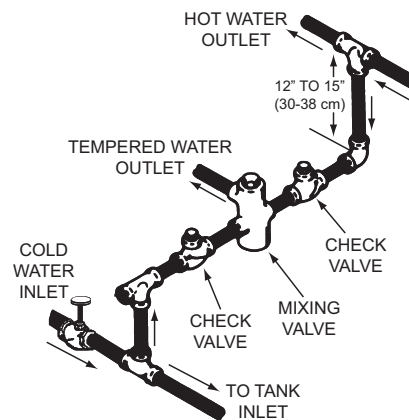

FIGURE 6.

## WATER PIPING

### WATER (POTABLE) HEATING AND SPACE HEATING

# ⚠ WARNING

## Toxic Chemical Hazard

- Do not connect to non-potable water system.

This water heater shall not be connected to any heating systems or component(s) used with a non-potable water heating appliance.

All piping components connected to this unit for space heating applications shall be suitable for use with potable water.

Toxic chemicals, such as those used for boiler treatment shall not be introduced into this system.

When the system requires water for space heating at temperatures higher than required for domestic water purposes, a mixing valve must be installed. Please refer to Figure 6 for suggested piping arrangement.

These water heaters cannot be used in space heating applications only.

### CLOSED WATER SYSTEMS

Water supply systems may, because of code requirements or such conditions as high line pressure, among others, have installed devices such as pressure reducing valves, check valves, and back flow preventers. Devices such as these cause the water system to be a closed system.

### THERMAL EXPANSION

As water is heated, it expands (thermal expansion). In a closed system the volume of water will grow when it is heated. As the volume of water grows there will be a corresponding increase in water pressure due to thermal expansion. Thermal expansion can cause premature tank failure (leakage). This type of failure is not covered under the limited warranty. Thermal expansion can also cause intermittent Temperature-Pressure Relief Valve operation: water discharged from the valve due to excessive pressure build up. This condition is not covered under the limited warranty. The Temperature-Pressure Relief Valve is not intended for the constant relief of thermal expansion.

A properly sized thermal expansion tank must be installed on all closed systems to control the harmful effects of thermal expansion. Contact a local plumbing service technician to have a thermal expansion tank installed.

# CAUTION

## Property Damage Hazard

- Avoid water heater damage.
- Install thermal expansion tank if necessary.
- Do not apply heat to cold water inlet.
- Contact qualified installer or service agency.

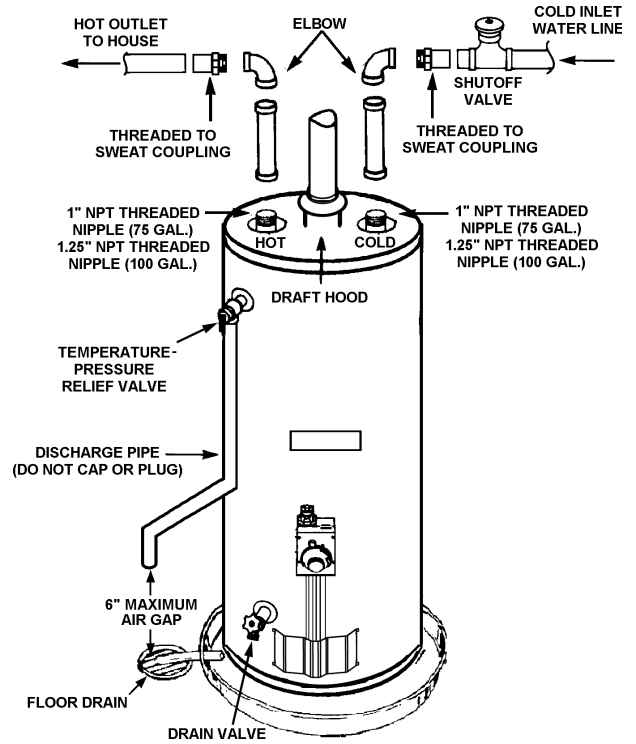

FIGURE 7.

**NOTE:** To protect against untimely corrosion of hot and cold water fittings, it is strongly recommended that di-electric unions or couplings be installed on this water heater when connected to copper pipe.

Figure 7 shows the typical attachment of the water piping to the water heater.

### TEMPERATURE-PRESSURE RELIEF VALVE

# ⚠ WARNING

## Explosion Hazard

- Temperature-Pressure Relief Valve must comply with ANSI Z21.22- CSA 4.4 and ASME code.
- Properly sized temperature-pressure relief valve must be installed in opening provided.
- Can result in overheating and excessive tank pressure.
- Can cause serious injury or death.

This water heater is provided with a properly rated/sized and certified combination Temperature-Pressure Relief Valve (T&P valve) by the manufacturer. The valve is certified by a nationally recognized testing laboratory that maintains periodic inspection of production of listed equipment of materials as meeting the requirements for Relief Valves for Hot Water Supply Systems, ANSI Z21.22 • CSA 4.4, and the code requirements of ASME.

If replaced, the new T&P valve must meet the requirements of local codes, but not less than a combination Temperature-Pressure Relief Valve rated/sized and certified as indicated in the above paragraph. The new valve must be marked with a maximum set pressure not to exceed the marked hydrostatic working pressure of the water heater (150 psi = 1,035 kPa) and a discharge capacity not less than the water heater Btu/hr or kW input rate as shown on the water heater's model rating label.

**NOTE:** In addition to the factory installed Temperature-Pressure Relief Valve on the water heater, each remote storage tank that may be installed and piped to a water heating appliance must also have its own properly sized, rated and approved Temperature-Pressure Relief Valve installed. Call the toll free technical support phone number listed on the back cover of this manual for technical assistance in sizing a Temperature-Pressure Relief Valve for remote storage tanks.

For safe operation of the water heater, the Temperature-Pressure Relief Valve must not be removed from its designated opening nor plugged. The Temperature-Pressure Relief Valve must be installed directly into the fitting of the water heater designed for the relief valve. Install discharge piping so that any discharge will exit the pipe within 6 inches (15.2 cm) above an adequate floor drain, or external to the building. In cold climates it is recommended that it be terminated at an adequate drain inside the building. Be certain that no contact is made with any live electrical part. The discharge opening must not be blocked or reduced in size under any circumstances. Excessive length, over 30 feet (9.14 m), or use of more than four elbows can cause restriction and reduce the discharge capacity of the valve.

No valve or other obstruction is to be placed between the Temperature-Pressure Relief Valve and the tank. Do not connect discharge piping directly to the drain unless a 6" (15.2 cm) air gap is provided. To prevent bodily injury, hazard to life, or property damage, the relief valve must be allowed to discharge water in adequate quantities should circumstances demand. If the discharge pipe is not connected to a drain or other suitable means, the water flow may cause property damage.

<b>CAUTION</b>
<b>Water Damage Hazard</b>
<ul style="list-style-type: none"> <li>• Temperature -Pressure Relief Valve discharge pipe must terminate at adequate drain.</li> </ul>

**T&P Valve Discharge Pipe Requirements:**

- Shall not be smaller in size than the outlet pipe size of the valve, or have any reducing couplings or other restrictions.
- Shall not be plugged or blocked.
- Shall not be exposed to freezing temperatures.
- Shall be of material listed for hot water distribution.
- Shall be installed so as to allow complete drainage of both the Temperature-Pressure Relief Valve and the discharge pipe.
- Must terminate a maximum of six inches above a floor drain or external to building. In cold climates, it is recommended that discharge pipe be terminated at an adequate drain inside building.
- Shall not have any valve or other obstruction between the relief valve and the drain.

<b>⚠ DANGER</b>	<ul style="list-style-type: none"> <li>• Burn hazard.</li> <li>• Hot water discharge.</li> <li>• Keep clear of Temperature-Pressure Relief Valve discharge outlet.</li> </ul>

The Temperature-Pressure Relief Valve must be manually operated at least twice a year. Caution should be taken to ensure that (1) no one is in front of or around the outlet of the Temperature-Pressure Relief Valve discharge line, and (2) the water manually discharged will not cause any bodily injury or property damage because the water may be extremely hot. If after manually operating the valve, it fails to completely reset and continues to release water, immediately close the cold water inlet to the water heater, follow the draining instructions in this manual, and replace the Temperature-Pressure Relief Valve with a properly rated/sized new one.

**NOTE:** The purpose of a Temperature-Pressure Relief Valve is to prevent excessive temperatures and pressures in the storage tank. The T&P valve is not intended for the constant relief of thermal expansion. A properly sized thermal expansion tank must be installed on all closed systems to control thermal expansion, see Closed Water Systems and Thermal Expansion on page 11.

If you do not understand these instructions or have any questions regarding the Temperature-Pressure Relief Valve call the toll free number listed on the back cover of this manual for technical assistance.

**FILLING THE WATER HEATER**

<b>CAUTION</b>
<b>Property Damage Hazard</b>
<ul style="list-style-type: none"> <li>• Avoid water heater damage.</li> <li>• Fill tank with water before operating.</li> </ul>

Never use this water heater unless it is completely full of water. To prevent damage to the tank, the tank must be filled with water. Water must flow from the hot water faucet before turning "ON" gas to the water heater.

To fill the water heater with water:

1. Close the water heater drain valve by turning the handle to the right (clockwise). The drain valve is on the lower front of the water heater.
2. Open the cold water supply valve to the water heater. **NOTE:** The cold water supply valve must be left open when the water heater is in use.
3. To insure complete filling of the tank, allow air to exit by opening the nearest hot water faucet. Allow water to run until a constant flow is obtained. This will let air out of the water heater and the piping.
4. Check all water piping and connections for leaks. Repair as needed.

**AIR REQUIREMENTS**

<b>⚠ WARNING</b>	
<b>Breathing Hazard - Carbon Monoxide Gas</b>	
	<ul style="list-style-type: none"> <li>• Install water heater in accordance with the Instruction Manual and NFPA 54.</li> <li>• To avoid injury, combustion and ventilation air must be taken from outdoors.</li> <li>• Do not place chemical vapor emitting products near water heater.</li> </ul>
Breathing carbon monoxide can cause brain damage or death. Always read and understand instruction manual.	

For safe operation an adequate supply of fresh uncontaminated air for combustion and ventilation must be provided.

An insufficient supply of air can cause recirculation of combustion products resulting in contamination that may be hazardous to life. Such a condition often will result in a yellow, luminous burner flame, causing sooting of the combustion chamber, burners and flue tubes and creates a risk of asphyxiation.

Do not install the water heater in a confined space unless an adequate supply of air for combustion and ventilation is brought in to that space using the methods described in the Confined Space section that follows.

Never obstruct the flow of ventilation air. If you have any doubts or questions at all, call your gas supplier. Failure to provide the proper

amount of combustion air can result in a fire or explosion and cause property damage, serious bodily injury or death.

## UNCONFINED SPACE

An Unconfined Space is one whose volume is not less than 50 cubic feet per 1,000 Btu/hr (4.8 cubic meters per kW) of the total input rating of all appliances installed in the space. Rooms communicating directly with the space, in which the appliances are installed, through openings not furnished with doors, are considered a part of the unconfined space.

Makeup air requirements for the operation of exhaust fans, kitchen ventilation systems, clothes dryers and fireplaces shall also be considered in determining the adequacy of a space to provide combustion, ventilation and dilution air.

## UNUSUALLY TIGHT CONSTRUCTION

In unconfined spaces in buildings, infiltration may be adequate to provide air for combustion, ventilation and dilution of flue gases. However, in buildings of unusually tight construction (for example, weather stripping, heavily insulated, caulked, vapor barrier, etc.) additional air must be provided using the methods described in the Confined Space section that follows.

## CONFINED SPACE

A Confined Space is one whose volume is less than 50 cubic feet per 1,000 Btu/hr (4.8 cubic meters per kW) of the total input rating of all appliances installed in the space.

Openings must be installed to provide fresh air for combustion, ventilation and dilution in confined spaces. The required size for the openings is dependent on the method used to provide fresh air to the confined space and the total Btu/hr input rating of all appliances installed in the space.

## DIRECT VENT APPLIANCES

Appliances installed in a Direct Vent configuration that derive all air for combustion from the outdoor atmosphere through sealed intake air piping are not factored in the total appliance input Btu/hr calculations used to determine the size of openings providing fresh air into confined spaces.

## EXHAUST FANS

Where exhaust fans are installed, additional air shall be provided to replace the exhausted air. When an exhaust fan is installed in the same space with a water heater, sufficient openings to provide fresh air must be provided that accommodate the requirements for all appliances in the room and the exhaust fan. Undersized openings will cause air to be drawn into the room through the water heater's vent system causing poor combustion. Sooting, serious damage to the water heater and the risk of fire or explosion may result. It can also create a risk of asphyxiation.

## LOUVERS AND GRILLES

The free areas of the fresh air openings in the instructions that follow do not take in to account the presence of louvers, grilles or screens in the openings.

The required size of openings for combustion, ventilation and dilution air shall be based on the "net free area" of each opening. Where the free area through a design of louver or grille or screen is known, it shall be used in calculating the size of opening required to provide the free area specified. Where the louver and grille design and free area are not known, it shall be assumed that wood louvers will have 25% free area and metal louvers and grilles will have 75% free area. Non motorized louvers and grilles shall be fixed in the open position.

## FRESH AIR OPENINGS FOR CONFINED SPACES

The following instructions shall be used to calculate the size, number and placement of openings providing fresh air for combustion, ventilation and dilution in confined spaces. The illustrations shown in this section of the manual are a reference for the openings that provide fresh air into confined spaces only. Do not refer to these illustrations for the purpose of vent installation. See Venting Installation on page 14 for complete venting installation instructions.

## OUTDOOR AIR THROUGH TWO OPENINGS

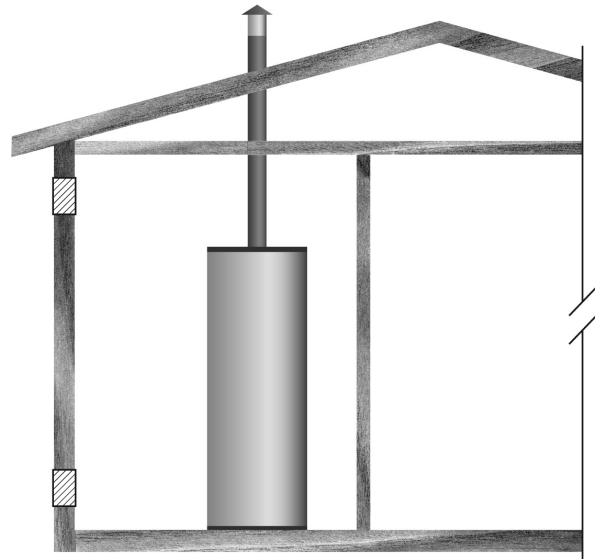

FIGURE 8.

The confined space shall be provided with two permanent openings, one commencing within 12 inches (300 mm) of the top and one commencing within 12 inches (300 mm) of the bottom of the enclosure. The openings shall communicate directly with the outdoors. See Figure 8.

Each opening shall have a minimum free area of 1 square inch per 4,000 Btu/hr (550 mm<sup>2</sup> per kW) of the aggregate input rating of all appliances installed in the enclosure. Each opening shall not be less than 100 square inches (645 cm<sup>2</sup>).

## OUTDOOR AIR THROUGH ONE OPENING

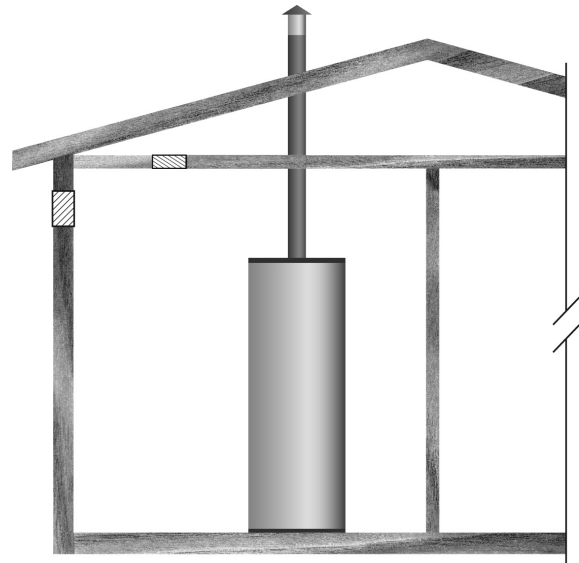

FIGURE 9.

Alternatively a single permanent opening, commencing within 12 inches (300 mm) of the top of the enclosure, shall be provided. See Figure 9. The water heater shall have clearances of at least 1 inch (25 mm) from the sides and back and 6 inches (150 mm) from the front of the appliance. The opening shall directly communicate with the outdoors or shall communicate through a vertical or horizontal duct to the outdoors or spaces that freely communicate with the outdoors and shall have a minimum free area of the following:

- 1 square inch per 3000 Btu/hr (733 mm<sup>2</sup> per kW) of the total input rating of all appliances located in the enclosure, and
- Not less than the sum of the areas of all vent connectors in the space.

## OUTDOOR AIR THROUGH TWO HORIZONTAL DUCTS

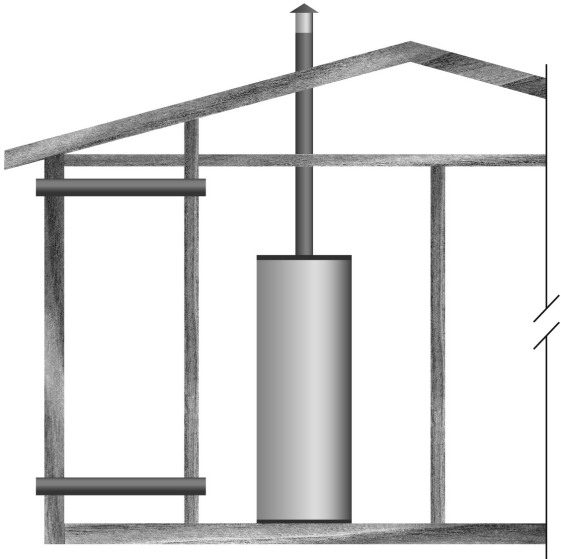

FIGURE 10.

The confined space shall be provided with two permanent horizontal ducts, one commencing within 12 inches (300 mm) of the top and one commencing within 12 inches (300 mm) of the bottom of the enclosure. The horizontal ducts shall communicate directly with the outdoors. See Figure 10.

Each duct opening shall have a minimum free area of 1 square inch per 2,000 Btu/hr (1100 mm<sup>2</sup> per kW) of the aggregate input rating of all appliances installed in the enclosure.

When ducts are used, they shall be of the same cross sectional area as the free area of the openings to which they connect. The minimum dimension of rectangular air ducts shall be not less than 3 inches.

## OUTDOOR AIR THROUGH TWO VERTICAL DUCTS

The illustrations shown in this section of the manual are a reference for the openings that provide fresh air into confined spaces only.

**DO NOT** refer to these illustrations for the purpose of vent installation. See Venting Installation on page 14 for complete venting installation instructions.

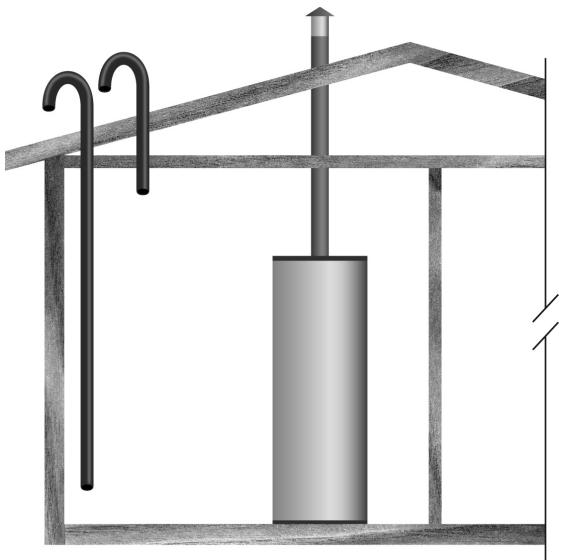

FIGURE 11.

The confined space shall be provided with two permanent vertical ducts, one commencing within 12 inches (300 mm) of the top and one commencing within 12 inches (300 mm) of the bottom of the

enclosure. The vertical ducts shall communicate directly with the outdoors. See Figure 11.

Each duct opening shall have a minimum free area of 1 square inch per 4,000 Btu/hr (550 mm<sup>2</sup> per kW) of the aggregate input rating of all appliances installed in the enclosure.

When ducts are used, they shall be of the same cross sectional area as the free area of the openings to which they connect. The minimum dimension of rectangular air ducts shall be not less than 3 inches.

## AIR FROM OTHER INDOOR SPACES

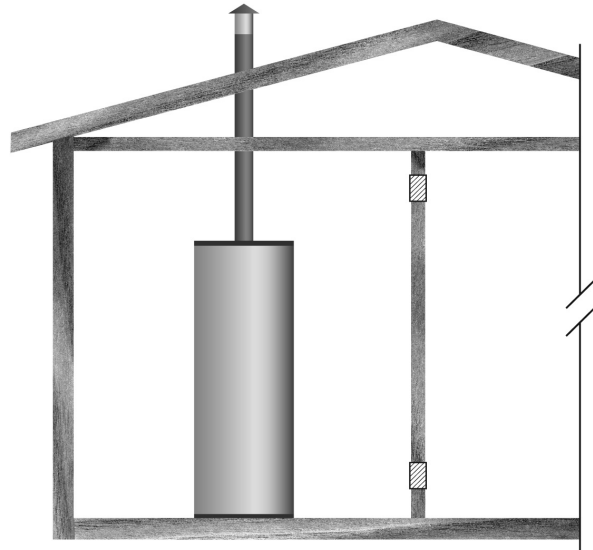

FIGURE 12.

The confined space shall be provided with two permanent openings, one commencing within 12 inches (300 mm) of the top and one commencing within 12 inches (300 mm) of the bottom of the enclosure. See Figure 12.

Each opening shall communicate directly with an additional room(s) of sufficient volume so that the combined volume of all spaces meets the criteria for an Unconfined Space.

Each opening shall have a minimum free area of 1 square inch per 1,000 Btu/hr (2200 mm<sup>2</sup> per kW) of the aggregate input rating of all appliances installed in the enclosure. Each opening shall not be less than 100 square inches (645 cm<sup>2</sup>).

## VENTING

<b>⚠ WARNING</b>	
<b>Breathing Hazard - Carbon Monoxide Gas</b>	
	<ul style="list-style-type: none"> <li>• Vent dampers must be certified in accordance with ANSI Z21.66/CGA 6.14.</li> <li>• Vent damper must permit proper drafting of water heater.</li> <li>• Install properly sized venting.</li> <li>• Do not install without venting outdoors.</li> <li>• Do not install without drafthood.</li> <li>• If common vented install in accordance with NFPA 54.</li> <li>• Be alert for obstructed or deteriorated vent system to avoid serious injury or death.</li> </ul>
<p>Breathing carbon monoxide can cause brain damage or death. Always read and understand instruction manual.</p>	

If the water heater is being installed as a replacement for an existing heater in pre-existing venting, a thorough inspection of existing venting system must be performed prior to any installation work.

**VENT DAMPERS** - Any vent damper, whether it is operated thermally or otherwise must be removed if its use inhibits proper drafting of the water heater.

**Thermally Operated Vent Dampers:** this gas-fired water heater has a thermal efficiency at or above 80% which may produce a relatively low flue gas temperature. Such temperatures may not be high enough to properly open thermally operated vent dampers. This would cause spillage of the flue gases and may cause carbon monoxide poisoning. Vent dampers must bear evidence of certification as complying with the current edition of the American National Standard ANSI Z21.66 CGA 6.14 (covering electrically and mechanically actuated vent dampers). Before installation of any vent damper, consult the local gas utility for further information.

To insure proper venting of this gas-fired water heater, the correct vent pipe diameter must be utilized. Any additions or deletions of other gas appliances on a common vent with this water heater may adversely affect the operation of the water heater. Consult your gas supplier if any such changes are planned.

For proper venting in certain installations, a larger diameter vent pipe may be necessary. Consult your gas supplier to aid you in determining the proper venting for your water heater from the vent tables in the current edition of the National Fuel Gas Code ANSI Z223.1/NFPA 54.

Periodically check the venting system for signs of obstruction or deterioration and replace if needed.

The combustion and ventilation air flow must not be obstructed.

The water heater with draft hood installed must be connected to a chimney or listed vent pipe system, which terminates to the outdoors. Never operate the water heater unless it is vented to the outdoors and has adequate air supply to avoid risks of improper operation, explosion or asphyxiation.

Align the legs of the draft hood with the holes provided. Insert the legs and secure the draft hood to the water heater's top with the four screws provided as shown in Figure 13. Do not alter the draft hood in any way. If you are replacing an existing water heater, be sure to use the new draft hood supplied with the water heater.

Obstructed or deteriorated vent systems may present serious health risk or asphyxiation.

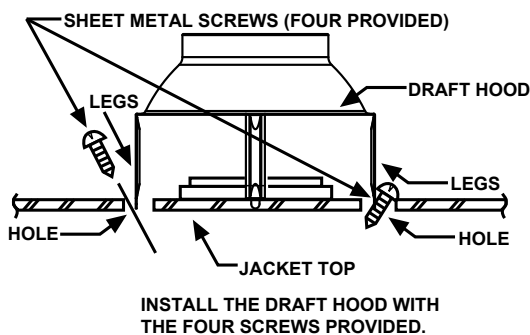
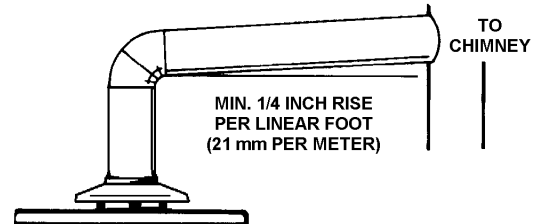

**FIGURE 13.**

The vent pipe from the water heater must be no less than the diameter of the draft hood outlet on the water heater and must slope upward at least 1/4 inch per linear foot (21 mm per meter). See Figure 14.

All vent gases must be completely vented to the outdoors of the structure (dwelling). Install only the draft hood provided with the new water heater and no other draft hood.

Vent pipes must be secured at each joint with sheet metal screws.



**FIGURE 14.**

There must be a minimum of 6" (153 mm) clearance between single wall vent pipe and any combustible material. Fill and seal any clearance between single wall vent pipe and combustible material with mortar mix, cement, or other noncombustible substance. For other than single wall, follow vent pipe manufacturer's clearance specifications. To insure a tight fit of the vent pipe in a brick chimney, seal around the vent pipe with mortar mix cement.

Failure to have required clearances between vent piping and combustible material will result in a fire hazard.

Be sure vent pipe is properly connected to prevent escape of dangerous flue gases which could cause deadly asphyxiation.

<b>⚠ WARNING</b>	
<b>Breathing Hazard - Carbon Monoxide Gas</b>	
	<ul style="list-style-type: none"> <li>• Flue gases may escape if vent pipe is not connected.</li> <li>• Do not store corrosive chemicals in vicinity of water heater.</li> <li>• Chemical corrosion of flue and vent system can cause serious injury or death.</li> <li>• Contact a qualified installer or service agency.</li> </ul>
<p>Breathing carbon monoxide can cause brain damage or death. Always read and understand instruction manual.</p>	

Chemical vapor corrosion of the flue and vent system may occur if air for combustion contains certain chemical vapors. Spray can propellants, cleaning solvents, refrigerator and air conditioner refrigerants, swimming pool chemicals, calcium and sodium chloride, waxes, bleach and process chemicals are typical compounds which are potentially corrosive.

**GAS PIPING**

**TABLE 4.**

## ⚠ WARNING

### Fire and Explosion Hazard

- Do not use water heater with any gas other than the gas shown on the rating plate.
- Excessive pressure to gas control valve can cause serious injury or death.
- Turn off gas lines during installation.
- Contact qualified installer or service agency.

LENGTH IN METERS	NOMINAL IRON PIPE SIZES (INCHES) INPUT IN KW								
	1/2"	3/4"	1"	1 1/4"	1 1/2"	2"	2 1/2"	3"	4"
3	51	105	199	410	615	1160	1845	3221	6735
6	35	73	142	278	428	805	1277	2255	4626
9	28	59	110	225	346	644	1031	1830	3748
12	24	50	94	193	290	556	878	1552	3192
15	21	44	83	170	264	492	776	1391	2840
18	19	40	76	155	237	445	703	1259	2577
21	18	37	70	143	220	410	659	1142	2372
24	17	35	64	135	202	381	600	1083	2196
27	16	32	60	126	190	357	571	1010	2108
31	15	30	57	117	182	337	542	952	1962
38	13	27	51	105	161	299	483	864	1757
46	12	25	47	95	146	278	439	776	1610
53	11	23	42	88	135	249	401	717	1464
61	10	21	40	82	126	234	375	688	1347

Contact your local gas service company to ensure that adequate gas service is available and to review applicable installation codes for your area.

Size the main gas line in accordance with Table 3. The figures shown are for straight lengths of pipe at 0.5 in. W.C. pressure drop, which is considered normal for low pressure systems. Note: Fittings such as elbows, tees and line regulators will add to the pipe pressure drop. Also refer to the current edition of the National Fuel Gas Code (NFPA 54).

Make sure gas supplied is same type listed on model rating plate. The inlet gas pressure must not exceed 14 inch water column (2.6 kPa) for natural and propane (L.P.) gas. The minimum inlet gas pressure shown on rating plate is that which will permit firing at rated input.

If the gas control valve is subjected to pressures exceeding 1/2 pound per square inch (3.5 kPa), the damage to the gas control valve could result in a fire or explosion from leaking gas.

If the main gas line shut-off serving all gas appliances is used, also turn "off" the gas at each appliance. Leave all gas appliances shut "off" until the water heater installation is complete.

A gas line of sufficient size must be run to the water heater. Consult the current edition of National Fuel Gas Code ANSI Z223.1/NFPA 54 and your gas supplier concerning pipe size.

There must be:

- A readily accessible manual shut off valve in the gas supply line serving the water heater, and
- A sediment trap ahead of the gas control valve to help prevent dirt and foreign materials from entering the gas control valve.
- A flexible gas connector or a ground joint union between the shut off valve and control valve to permit servicing of the unit.

Be sure to check all the gas piping for leaks before lighting the water heater. Use a soapy water solution, not a match or open flame. Rinse off soapy solution and wipe dry.

The minimum inlet gas pressure shown on the rating plate is that which will permit firing at the rated input.

**TABLE 3. GAS SUPPLY LINE SIZES (IN INCHES)\*  
MAXIMUM CAPACITY OF PIPE IN CUBIC FEET PER HOUR**

LENGTH IN FEET	NOMINAL IRON PIPE SIZES (INCHES) INPUT IN THOUSANDS (BTU/HR)								
	1/2"	3/4"	1"	1 1/4"	1 1/2"	2"	2 1/2"	3"	4"
10	175	360	680	1400	2100	3960	6300	11000	23000
20	120	250	465	950	1460	2750	4360	7700	15800
30	97	200	375	770	1180	2200	3520	6250	12800
40	82	170	320	660	990	1900	3000	5300	10900
50	73	151	285	580	900	1680	2650	4750	9700
60	66	138	260	530	810	1520	2400	4300	8800
70	61	125	240	490	750	1400	2250	3900	8100
80	57	118	220	460	690	1300	2050	3700	7500
90	53	110	205	430	650	1220	1950	3450	7200
100	50	103	195	400	620	1150	1850	3250	6700
125	44	93	175	360	550	1020	1650	2950	6000
150	40	84	160	325	500	950	1500	2650	5500
175	37	77	145	300	460	850	1370	2450	5000
200	35	72	135	280	430	800	1280	2280	4600

## ⚠ WARNING

### Fire and Explosion Hazard

- Use joint compound or tape compatible with propane.
- Leak test before operating heater.
- Disconnect gas piping and shut-off valve before pressure testing system.

Use pipe joint compound or teflon tape marked as being resistant to the action of petroleum [Propane (L.P.)] gases.

The water heater and its gas connection must be leak tested before placing the water heater in operation.

The water heater and its individual shut-off valve shall be disconnected from the gas supply piping system during any pressure testing of that system at test pressures in excess of 1/2 pound per square inch (3.5 kPa). It shall be isolated from the gas supply piping system by closing its individual manual shut-off valve during any pressure testing of the gas supply piping system at test pressures equal to or less than 1/2 pound per square inch (3.5 kPa).

Connecting the gas piping to the gas control valve of the water heater can be accomplished by either of the two methods shown in Figures 15 and 16.

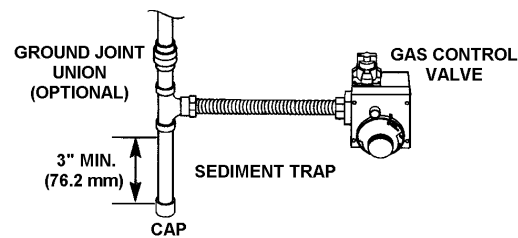

**FIGURE 15. GAS PIPING WITH FLEXIBLE CONNECTOR.**

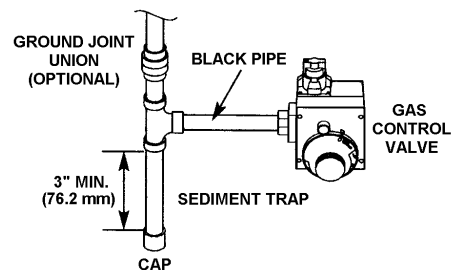

**FIGURE 16. GAS PIPING WITH ALL BLACK IRON PIPE TO GAS CONTROL.**



## SEDIMENT TRAPS

A sediment trap shall be installed as close to the inlet of the water heater as practical at the time of water heater installation. The sediment trap shall be either a tee fitting with a capped nipple in the bottom outlet or other device recognized as an effective sediment trap. If a tee fitting is used, it shall be installed in conformance with one of the methods of installation shown in the Figures 15 and 16.

Contaminants in the gas lines may cause improper operation of the gas control valve that may result in fire or explosion. Before attaching the gas line be sure that all gas pipe is clean on the inside. To trap any dirt or foreign material in the gas supply line, a sediment trap must be incorporated in the piping. The sediment trap must be readily accessible. Install in accordance with the "Gas Piping" section. Refer to the current edition of the National Fuel Gas Code, ANSI Z223.1/NFPA 54.

	<b>⚠ WARNING</b>
	<b>Fire and Explosion Hazard</b> <ul style="list-style-type: none"><li>• Contaminants in gas lines can cause fire or explosion.</li><li>• Clean all gas piping before installation.</li><li>• Install sediment trap in accordance with NFPA 54.</li></ul>

# FOR YOUR SAFETY READ BEFORE LIGHTING



**WARNING:** If you do not follow these instructions exactly, a fire or explosion may result causing property damage, personal injury or loss of life.



## BEFORE LIGHTING: ENTIRE SYSTEM MUST BE FILLED WITH WATER AND AIR PURGED FROM ALL LINES

- A. This appliance has a pilot which is lit by a piezo-electric spark gas ignition system. When lighting the pilot, follow these instructions exactly.
- B. BEFORE LIGHTING smell all around the appliance area for gas. Be sure to smell next to the floor because some gas is heavier than air and will settle on the floor.
- WHAT TO DO IF YOU SMELL GAS
- Do not try to light any appliance.
  - Do not touch any electric switch; do not use any phone in your building.
  - Immediately call your gas supplier from a neighbor's phone. Follow the gas supplier's instructions.
- If you cannot reach your gas supplier, call the fire department.
- C. Use only your hand to push down or turn the gas control knob. Never use tools. If the knob will not push down or turn by hand, don't try to repair it, call a qualified service technician. Force or attempted repair may result in fire or explosion.
- D. Do not use this appliance if any part has been under water. Immediately contact a qualified installer or service agency to replace a flooded water heater. Do not attempt to repair the unit! It must be replaced!

## LIGHTING INSTRUCTIONS

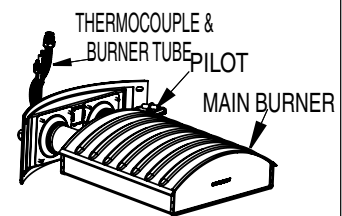
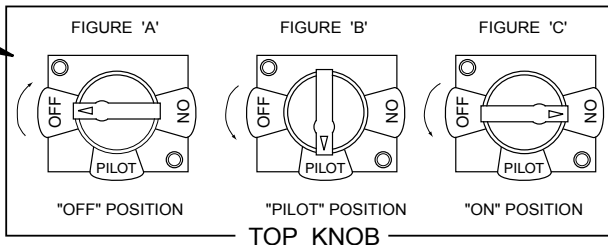
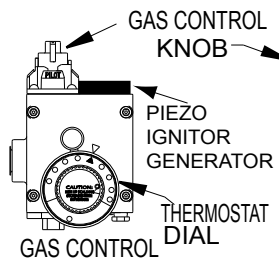

FIGURE "D"

1. **STOP!** Read the safety information above on this label.
  2. Set the thermostat to the lowest setting by turning thermostat dial fully clockwise until it stops.
  3. Push the gas control knob down slightly and turn clockwise to "OFF". SEE FIGURE 'A'.  
NOTE: Knob cannot be turned from "PILOT" to "OFF" unless knob is pushed down slightly. Do not force.
  4. Remove the outer door located below the gas control unit.
  5. Wait five (5) minutes to clear out any gas. If you then smell gas, **STOP!** Follow "B" in the safety information above on this label. If you do not smell gas, go to next step.
  6. This unit is equipped with a push button pilot ignitor, which is used to light the pilot. Locate the ignitor on the gas control.
  7. Turn gas control knob counterclockwise to "PILOT". SEE FIGURE 'B'.
  8. The pilot is located on the left front corner of the burner. It can be located by looking through the sight glass to the left while pressing the piezo ignitor button several times. Look for a spark at the pilot location.
  9. Once the pilot has been found, push the gas knob all the way down. Immediately press the pilot ignitor button rapidly (4) to (5) times. If the pilot does not light, repeat step (3) through (9).
  10. Continue to hold the gas control knob down for about one (1) minute after the pilot is lit. Release the gas control knob and it will pop back up. Pilot should remain lit. If it goes out, repeat step (3) through (9). It may take several minutes for air to clear the lines before the pilot will light.
    - If knob does not pop up when released, stop and immediately call your service technician or gas supplier.
    - If the pilot will not stay lit after several tries, turn the gas control knob clockwise to 'OFF' and call your service technician or gas supplier. SEE FIGURE 'A'
  11. Replace the outer door.
  12. At arm's length away, turn gas control knob counterclockwise to 'ON'. SEE FIGURE 'C'.
  13. Set thermostat to desired setting.
- ! DANGER: Hotter water increases the risk of scald injury. Consult the instruction manual before changing temperature.**

## TO TURN OFF GAS TO APPLIANCE

1. Set the thermostat to lowest setting.
2. Push gas control knob down slightly and turn clockwise to 'OFF'. Do not force. SEE FIGURE 'A'.

# TEMPERATURE REGULATION

Short repeated heating cycles caused by small hot water uses can cause temperatures at the point of use to exceed the thermostat setting by up to 30°F (16.7°C). If you experience this type of use you should consider using lower temperature settings to reduce scald hazards.

Any water heater's intended purpose is to heat water. Hot water is needed for cleansing, cleaning, and sanitizing (bodies, dishes, clothing). Untempered hot water can present a scald hazard. Depending on the time element, and the people involved (adults, children, elderly, infirm, etc.) scalding may occur at different temperatures.

▲ DANGER

Water temperature over 125°F (52°C) can cause severe burns instantly resulting in severe injury or death.

Children, the elderly, and the physically or mentally disabled are at highest risk for scald injury.

Feel water before bathing or showering.

Temperature limiting valves are available.

Read instruction manual for safe temperature setting.

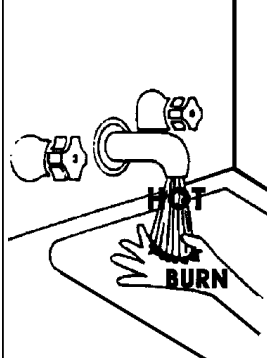

**HOTTER WATER CAN SCALD:** Water heaters are intended to produce hot water. Water heated to a temperature which will satisfy space heating, clothes washing, dish washing, and other sanitizing needs can scald and permanently injure you upon contact. Some people are more likely to be permanently injured by hot water than others. These include the elderly, children, the infirm, or physically/mentally handicapped. If anyone using hot water in your home fits into one of these groups or if there is a local code or state law requiring a certain temperature water at the hot water tap, then you must take special precautions. In addition to using the lowest possible temperature setting that satisfies your hot water needs, a means such as a mixing valve should be used at the hot water taps used by these people or at the water heater. Mixing valves are available at plumbing supply or hardware stores, see Figure 6. Follow manufacturer's instructions for installation of the valves. Before changing the factory setting on the thermostat, read the "Temperature Regulation" section in this manual, see Figures 17 and 18.

Never allow small children to use a hot water tap, or to draw their own bath water. Never leave a child or handicapped person unattended in a bathtub or shower.

**NOTE:** A water temperature range of 120°F-140°F (49°C-60°C) is recommended by most dishwasher manufacturers.

The thermostat of this water heater has been factory set at its lowest position (PILOT LIGHTING). It is adjustable and must be reset to the desired temperature setting to reduce the risk of scald injury. The mark (▲) indicative of approximately 120°F (49°C) is preferred starting point. Some States have a requirement for a lower setting.

Turn the water temperature dial clockwise (↻) to decrease the temperature, or counterclockwise (↺) to increase the temperature.

Should overheating occur or the gas supply fail to shut off, turn off the manual gas control valve to the water heater.

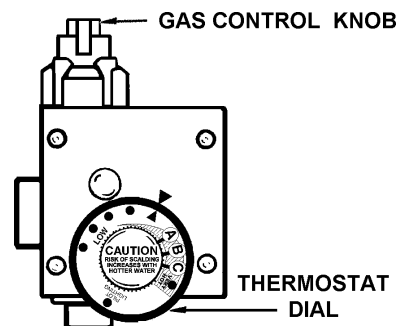

FIGURE 17.

Temperature Setting	Time to Produce 2nd & 3rd Degree Burns on Adult Skin
VERY HOT = APPROX. 160°F (71°C)	About 1/2 second
C = APPROX. 150°F (65°C)	About 1-1/2 seconds
B = APPROX. 140°F (60°C)	Less than 5 seconds
A = APPROX. 130°F (54°C)	About 30 seconds
▲ = APPROX. 120°F (49°C)	More than 5 minutes
LOW = APPROX. 90°F (32°C)	-----

FIGURE 18.

# FOR YOUR INFORMATION

## START UP CONDITIONS

### DRAFT HOOD OPERATION

Check draft hood operation by performing a worst case depressurization of the building. With all doors and windows closed, and with all air handling equipment and exhaust fans operating such as furnaces, clothes dryers, range hoods and bathroom fans, a match flame should still be drawn into the draft hood of the water heater with its burner firing. If the flame is not drawn toward the draft hood, shut off water heater and make necessary air supply changes to correct.

### CONDENSATION

Whenever the water heater is filled with cold water, some condensate will form while the burner is on. A water heater may

appear to be leaking when in fact the water is condensation. This usually happens when:

- A new water heater is filled with cold water for the first time.
- Burning gas produces water vapor in water heaters, particularly high efficiency models where flue temperatures are lower.
- Large amounts of hot water are used in a short time and the refill water in the tank is very cold.

Moisture from the products of combustion condense on the cooler tank surfaces and form drops of water which may fall onto the burner or other hot surfaces to produce a "sizzling" or "frying" noise.

Excessive condensation can cause pilot outage due to water running down the flue tube onto the main burner and putting out the pilot.

Because of the suddenness and amount of water, condensation water may be diagnosed as a “tank leak”. After the water in the tank warms up (about 1-2 hours), the condition should disappear.

Do not assume the water heater is leaking until there has been enough time for the water in the tank to warm up.

An undersized water heater will cause more condensation. The water heater must be sized properly to meet the family’s demands for hot water including dishwashers, washing machines and shower heads.

Excessive condensation may be noticed during the winter and early spring months when incoming water temperatures are at their lowest.

Good venting is essential for a gas fired water heater to operate properly as well as to carry away products of combustion and water vapor.

### SMOKE/ODOR

It is not uncommon to experience a small amount of smoke and odor during the initial start-up. This is due to burning off of oil from metal parts, and will disappear in a short while.

### STRANGE SOUNDS

Possible noises due to expansion and contraction of some metal parts during periods of heat-up and cool-down do not necessarily represent harmful or dangerous conditions.

Condensation causes sizzling and popping within the burner area during heating and cooling periods and should be considered normal. See “Condensation” in this section.

## OPERATIONAL CONDITIONS

---

### SMELLY WATER

In each water heater there is installed at least one anode rod for corrosion protection of the tank. Certain water conditions will cause a reaction between this rod and the water. The most common complaint associated with the anode rod is one of a “rotten egg smell” in the hot water. This odor is derived from hydrogen sulfide gas dissolved in the water. The smell is the result of four factors which must all be present for the odor to develop:

- a. A concentration of sulfate in the supply water.
- b. Little or no dissolved oxygen in the water.
- c. A sulfate reducing bacteria which has accumulated within the water heater (this harmless bacteria is nontoxic to humans).
- d. An excess of active hydrogen in the tank. This is caused by the corrosion protective action of the anode.

Smelly water may be eliminated or reduced in some water heater models by replacing the anode(s) with one of less active material, and then chlorinating the water heater tank and all hot water lines. Contact the local water heater supplier or service technician for further information concerning an Anode Replacement Kit and this chlorination treatment.

If the smelly water persists after the anode replacement and chlorination treatment, we can only suggest that chlorination or aeration of the water supply be considered to eliminate the water problem.

**Do not remove the anode leaving the tank unprotected. By doing so, all warranty on the water heater tank is voided.**

### “AIR” IN HOT WATER FAUCETS

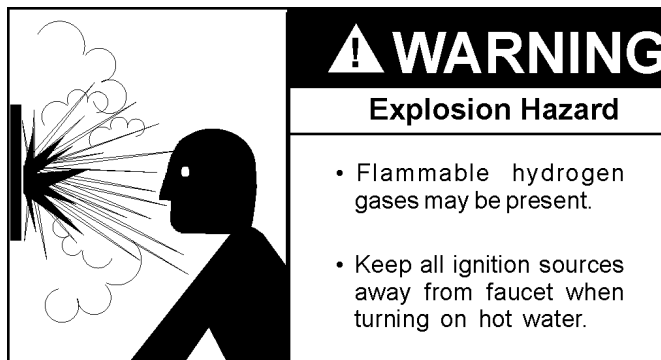

**HYDROGEN GAS:** Hydrogen gas can be produced in a hot water system that has not been used for a long period of time (generally two weeks or more). Hydrogen gas is extremely flammable and explosive. To prevent the possibility of injury under these conditions, we recommend the hot water faucet, located farthest away, be opened for several minutes before any electrical appliances which are connected to the hot water system are used (such as a dishwasher or washing machine). If hydrogen gas is present, there will probably be an unusual sound similar to air escaping through the pipe as the hot water faucet is opened. There must be no smoking or open flame near the faucet at the time it is open.

### HIGH WATER TEMPERATURE SHUT OFF SYSTEM

This water heater is equipped with an automatic gas Shut-off system. This system works when high water temperatures are present. The high temperature Shut-off is built into the gas control valve. It automatically resets when the temperature at thermostat level drops below 120 degrees Fahrenheit.

# PERIODIC MAINTENANCE

## VENTING SYSTEM INSPECTION

### ⚠ WARNING

#### Carbon Monoxide and Fire Hazard

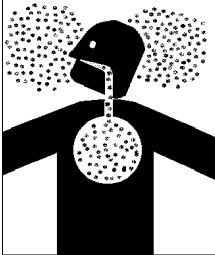

- Flue gases may escape if vent pipe is not connected.
- Be alert for obstructed, sooted or deteriorated vent system to avoid serious injury or death.
- Do not store corrosive chemicals in vicinity of water heater.
- Chemical corrosion of flue and vent system can cause serious injury or death.
- Contact a qualified installer or service agency.

Breathing carbon monoxide can cause brain damage or death. Always read and understand instruction manual.

At least once a year a visual inspection should be made of the venting system. You should look for:

1. Obstructions which could cause improper venting. The combustion and ventilation air flow must not be obstructed.
2. Damage or deterioration which could cause improper venting or leakage of combustion products.
3. Rusted flakes around top of water heater.

Be sure the vent piping is properly connected to prevent escape of dangerous flue gases which could cause deadly asphyxiation.

Obstructions and deteriorated vent systems may present serious health risk or asphyxiation.

Chemical vapor corrosion of the flue and vent system may occur if air for combustion contains certain chemical vapors. Spray can propellants, cleaning solvents, refrigerator and air conditioner refrigerants, swimming pool chemicals, calcium and sodium chloride, waxes, bleach and process chemicals are typical compounds which are potentially corrosive.

If after inspection of vent system you found sooting or deterioration, something is wrong. Call the local gas utility to correct problem and clean or replace the flue and venting before resuming operation of water heater.

## BURNER INSPECTION

Flood damage to a water heater may not be readily visible or immediately detectable. However, over a period of time a flooded water heater will create dangerous conditions which can cause DEATH, SERIOUS BODILY INJURY, OR PROPERTY DAMAGE. Contact a qualified installer or service technician to replace a flooded water heater. Do not attempt to repair the unit! It must be replaced!

At least once a year a visual inspection should be made of the main burner and pilot burner, see Figure 19. Inspect burner flames through viewport. Flames should be very small with a blue haze and small amounts of yellow or orange at the edges. After several minutes of operation the burner screen may glow red.

You should check for sooting. Soot is not normal and will impair proper combustion.

Soot build-up indicates a problem that requires correction before further use. Turn "OFF" gas to water heater and leave off until repairs are made, because failure to correct the cause of the

sooting can result in a fire causing death, serious injury, or property damage.

Flame Characteristics

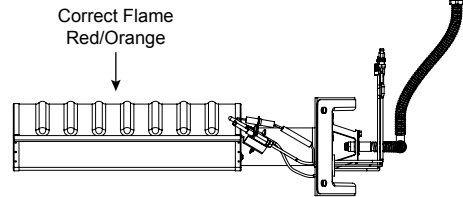

FIGURE 19.

Natural Gas (Low Nox)  
Burner Door Assembly

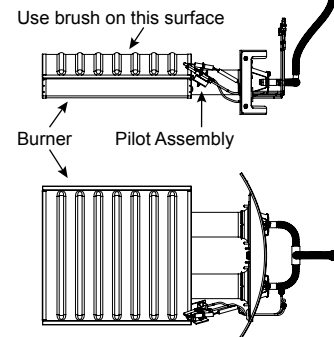

FIGURE 20.

## BURNER CLEANING

If inspection of the burner shows that cleaning is required, turn the gas control knob clockwise (↻) to the "OFF" position, depressing slightly.

**NOTE: The knob cannot be turned from "PILOT" to "OFF" unless knob is depressed slightly. DO NOT FORCE.**

Check the burner to see if it's dirty or clogged. The burner may be cleaned with a soft paint brush, see Figure 20. Do not use a wire brush or any tool that may damage the burner screen. Important: Do not use the burner if the burner screen is damaged. NOTE: Damage may be rips or holes in the burner screen. Discoloration is normal.

## HOUSEKEEPING



### ⚠ WARNING

#### Fire and Explosion Hazard

- Do not obstruct combustion air openings at the bottom of the water heater.
- Do not use or store flammable vapor products such as gasoline, solvents or adhesives in the same room or area near water heater or other appliance.
- Can cause serious injury or death.

Vacuum around base of water heater for dust, dirt, and lint on a regular basis.

INSTALLED IN SUITABLE AREA: To insure sufficient ventilation and combustion air supply, proper clearances from the water heater must be maintained. See Facts to Consider About The Location section. Combustible materials such as clothing, cleaning materials, or flammable liquids, etc. must not be placed against or adjacent to the water heater which can cause a fire.

## ANODE ROD INSPECTION

<b>CAUTION</b>
<b>Property Damage Hazard</b>
<ul style="list-style-type: none"> <li>• Avoid water heater damage.</li> <li>• Inspection and replacement of anode rod required.</li> </ul>

The anode rod is used to protect the tank from corrosion. Most hot water tanks are equipped with an anode rod. The submerged rod sacrifices itself to protect the tank. Instead of corroding the tank, water ions attack and eat away the anode rod. This does not affect water's taste or color. The rod must be maintained to keep the tank in operating condition.

Anode deterioration depends on water conductivity, not necessarily water condition. A corroded or pitted anode rod indicates high water conductivity and should be checked and/or replaced more often than an anode rod that appears to be intact. Replacement of a depleted anode rod can extend the life of your water heater. Inspection should be conducted by a qualified service technician, and at a minimum should be checked annually after the warranty period.

Artificially softened water is exceedingly corrosive because the process substitutes sodium ions for magnesium and calcium ions.

The use of a water softener may decrease the life of the water heater tank.

The anode rod should be inspected after a maximum of three years and annually thereafter until the condition of the anode rod dictates its replacement.

**NOTE:** Artificially softened water requires the anode rod to be inspected annually.

The following are typical (but not all) signs of a depleted anode rod:

- The majority of the rods diameter is less than 3/8".
- Significant sections of the support wire (approx. 1/3 or more of the anode rod's length) are visible.

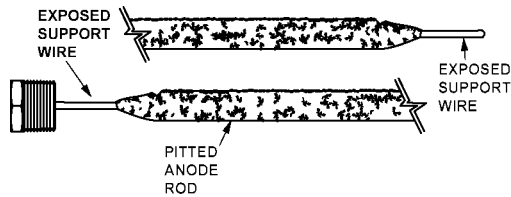

If the anode rod show signs of either or both it should be replaced.

**NOTE:** Whether re-installing or replacing the anode rod, check for any leaks and immediately correct if found.

In replacing the anode:

1. Turn off gas supply to the water heater.
2. Shut off the water supply and open a nearby hot water faucet to depressurize the water tank.
3. Drain approximately 5 gallons of water from tank. (Refer to "Draining and Flushing" for proper procedures). Close drain valve.
4. Remove old anode rod.
5. Use Teflon® tape or approved pipe sealant on threads and install new anode rod.
6. Turn on water supply and open a nearby hot water faucet to purge air from water system. Check for any leaks and immediately correct any if found.
7. Restart the water heater as directed in this manual. See the Repair Parts Illustration for anode rod location.

## TEMPERATURE-PRESSURE RELIEF VALVE TEST

<b>⚠ DANGER</b>	<ul style="list-style-type: none"> <li>• Burn hazard.</li> <li>• Hot water discharge.</li> <li>• Keep clear of Temperature-Pressure Relief Valve discharge outlet.</li> </ul>

It is recommended that the Temperature-Pressure Relief Valve should be checked to ensure that it is in operating condition every 6 months.

When checking the Temperature-Pressure Relief Valve operation, make sure that (1) no one is in front of or around the outlet of the Temperature-Pressure Relief Valve discharge line, and (2) that the water discharge will not cause any property damage, as the water may be extremely hot. Use care when operating valve as the valve may be hot.

To check the relief valve, lift the lever at the end of valve several times, see Figure 21. The valve should seat properly and operate freely.

If after manually operating the valve, it fails to completely reset and continues to release water, immediately close the cold water inlet to the water heater and drain the water heater, see Draining And Flushing on page 24. Replace the Temperature-Pressure Relief Valve with a properly rated/sized new one, see Temperature-Pressure Relief Valve on page 11 for instructions on replacement.

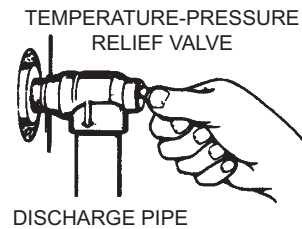

**FIGURE 21.**

If the Temperature-Pressure Relief Valve on the water heater weeps or discharges periodically, this may be due to thermal expansion.

**NOTE:** Excessive water pressure is the most common cause of Temperature-Pressure Relief Valve leakage. Excessive water system pressure is most often caused by "thermal expansion" in a "closed system." See Closed Water Systems and Thermal Expansion on page 11. The Temperature-Pressure Relief Valve is not intended for the constant relief of thermal expansion.

Temperature-Pressure Relief Valve leakage due to pressure build up in a closed system that does not have a thermal expansion tank installed is not covered under the limited warranty. Thermal expansion tanks must be installed on all closed water systems.

**DO NOT PLUG THE TEMPERATURE-PRESSURE RELIEF VALVE OPENING. THIS CAN CAUSE PROPERTY DAMAGE, SERIOUS INJURY OR DEATH.**

	<b>⚠ WARNING</b>
	<b>Explosion Hazard</b>
<ul style="list-style-type: none"> <li>• Temperature-Pressure Relief Valve must comply with ANSI Z21.22-CSA 4.4 and ASME code.</li> <li>• Properly sized temperature-pressure relief valve must be installed in opening provided.</li> <li>• Can result in overheating and excessive tank pressure.</li> <li>• Can cause serious injury or death.</li> </ul>	

## DRAINING AND FLUSHING

It is recommended that the water heater storage tank be drained and flushed every 6 months to reduce sediment buildup. The water heater should be drained if being shut down during freezing temperatures. See Installation Considerations in this manual for the location of the water heater components described below.

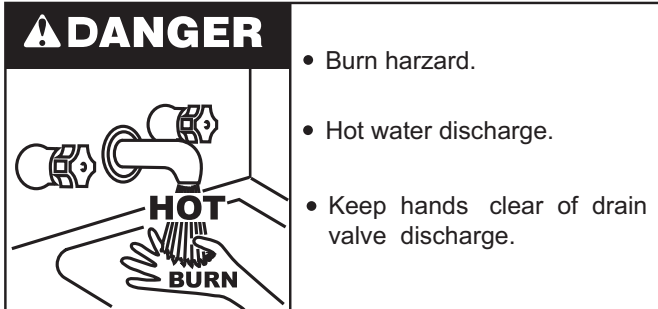

### TO DRAIN THE WATER HEATER STORAGE TANK:

1. Turn off the gas supply at the Main Gas Shutoff Valve if the water heater is going to be shut down for an extended period.
2. Ensure the cold water inlet valve is open.
3. Open a nearby hot water faucet and let the water run until the water is no longer hot.
4. Close the cold water inlet valve to the water heater.
5. Connect a hose to the water heater drain valve and terminate it to an adequate drain.
6. Open the water heater drain valve and allow all the water to drain from the storage tank.
7. Close the water heater drain valve when all water in the storage tank has drained.
8. Close the hot water faucet opened in Step 4.
9. If the water heater is going to be shut down for an extended period, the drain valve should be left open.

### TO FLUSH THE WATER HEATER STORAGE TANK:

1. Ensure the cold water inlet valve is open.
2. Open a nearby hot water faucet and let the water run until the water is no longer hot. Then close the hot water faucet.
3. Connect a hose to the drain valve and terminate it to an adequate drain.
4. Ensure the drain hose is secured before and during the entire flushing procedure. Flushing is performed with system water pressure applied to the water heater.
5. Open the water heater drain valve to flush the storage tank.
6. Flush the water heater storage tank to remove sediment and allow the water to flow until it runs clean.
7. Close the water heater drain valve when flushing is completed.
8. Remove the drain hose.
9. Fill the water heater - see Filling The Water Heater in this manual.
10. Turn on the gas supply to the water heater at the Main Gas Shutoff Valve.
11. Allow the water heater to complete several heating cycles to ensure it is operating properly.

### SERVICE

Before calling for repair service, read the "Start Up Conditions" and "Operational Conditions" found in the "For Your Information" section of this manual.

If a condition persists or you are uncertain about the operation of the water heater contact a service technician. If you are not thoroughly familiar with gas codes, your water heater, and safety practices, contact your gas supplier or qualified installer to check the water heater.

Use the "Leakage Checkpoints" guide to check a "Leaking" water heater. Many suspected "Leakers" are not leaking tanks. Often the source of the water can be found and corrected.

Read this manual first. Then before checking the water heater make sure the gas supply has been turned "OFF", and never turn the gas "ON" before the tank is completely full of water.

Never use this water heater unless it is completely filled with water. To prevent damage to the tank, the tank must be filled with water. Water must flow from the hot water faucet before turning "ON" gas to the water heater.

# REPLACING PARTS

## REPLACEMENT PARTS

**IMPORTANT:** The following maintenance procedures should be performed by a qualified person.

Replacement parts may be ordered through your plumber or the local distributor. Parts will be shipped at prevailing prices and billed accordingly. When ordering replacement parts, always have the following information ready:

1. model, serial and product number
2. item number
3. parts description

See "Repair Parts" section for a list of available repair parts.

## Removing the Burner Door Assembly

1. Turn off the gas to the water heater at the manual gas shut-off valve (Figure 1).
2. Turn the gas control knob on the combination gas control valve/thermostat clockwise to the off position.
3. Remove the outer door.
4. Disconnect the thermocouple (right-hand thread), pilot tube, the ignitor wire from the ignitor button, and manifold tube at the thermostat (Figure 21).
5. Remove the four screws at corners and the two sets of nuts and clips in the middle securing the burner door assembly to the combustion chamber (Figure 21.).
6. Grasp the manifold tube and push down slightly to free the manifold tube, pilot tube and thermocouple.
7. Carefully remove the burner door assembly from the combustion chamber. Be careful not to damage the burner screen or pilot assembly.

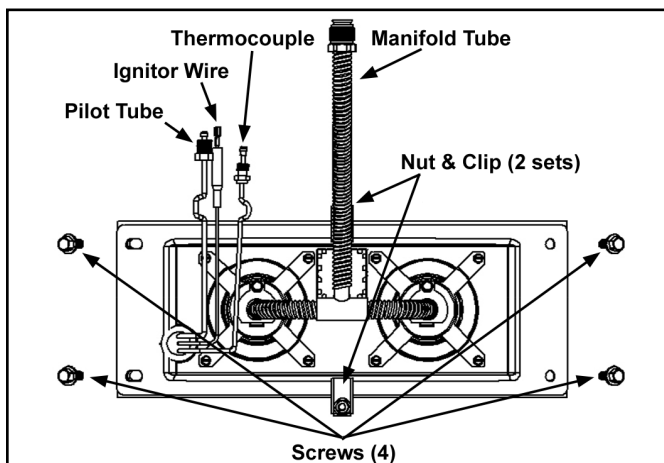

FIGURE 21

## Natural Gas Burner (Ultra Low Nox)

Check the burner screen to see if it is dirty or clogged. The burner screen may be cleaned with a soft paint brush. Do not use a wire brush or any tool that might damage the burner screen.

**!MPORTANT:** Do not use the burner if the burner screen is damaged.

**NOTE:** Damage would be rips or holes in the burner screen. Discoloration is normal.

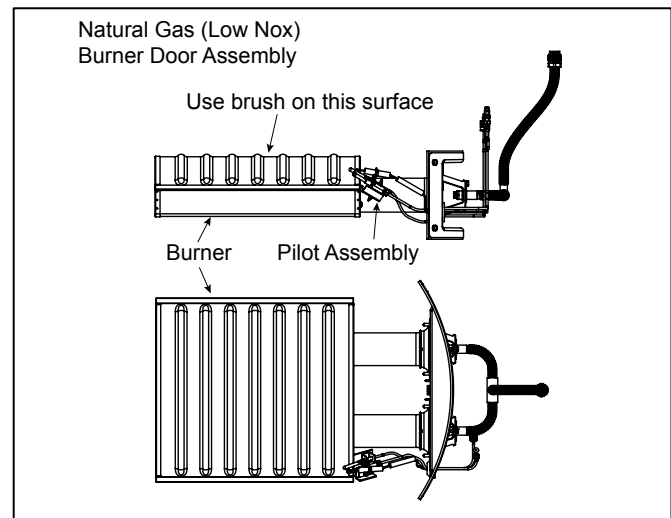

FIGURE 22

## Replacing the Pilot Assembly:

1. Follow the instructions in "Removing the Burner Door Assembly" section to remove the assembly.
2. Remove the screw securing the pilot assembly to the burner and keep it for reuse later.
3. Remove the old pilot assembly (including the ignitor wire) from the burner door assembly.
4. Use the screw removed previously step to secure the new pilot assembly to the burner.
5. Insert the ignitor wire, pilot tube and thermocouple through the hole in the burner door. Secure the grommet through the hole in the burner door and make sure good seal.
6. Follow the instructions in "Replacing the Burner Door Assembly" section to reinstall the assembly.



## Replacing the Burner Door Assembly

### **! WARNING**



#### **Explosion Hazard**

**Tighten burner door screws securely.**

**Remove any fiberglass between gasket and combustion chamber.**

**Replace viewport if glass is missing or damaged.**

**Replace manifold component block if missing or removed.**

**Replace door gasket if damaged.**

**Failure to follow these instructions can result in death, explosion, or fire.**

1. Check the door gasket for damage or imbedded debris prior to installation.
2. Inspect the viewport for damage and replace as required.
3. Insert the burner door assembly into the combustion chamber and slide it completely forward. Note: When inserting the burner door assembly, tip the burner end up slightly to ensure it engages with the burner bracket.
4. Inspect the door gasket and make sure there is no fiberglass insulation between the door gasket and the combustion chamber.
5. Replace the two sets of nuts and clips and the four screws securing the burner door assembly to the combustion chamber and tighten securely. Once the burner door assembly is tightened, visually inspect the door gasket between the burner door assembly and the combustion chamber for spaces or gaps that would prevent a seal. **IMPORTANT:** Do not operate the water heater if the door gasket does not create a seal between the burner door assembly and the combustion chamber.
6. Reconnect the manifold tubing, pilot tubing and thermocouple to the thermostat. Do not cross-thread or apply any thread sealant to these fittings. The thermocouple nut should be started and turned all the way by hand. An additional 1/2 - 3/4 turn with a 7/16" open end wrench will then be sufficient to seat the lockwasher.
7. Reconnect the igniter wire.
8. Turn the gas on and refer to the "Lighting Instructions"
9. Check for leaks by brushing on an approved leak detection solution. Bubbles will show a leak. Correct any leak found.
10. Replace the outer door.

## Piezoelectric Igniter System

The piezoelectric igniter system consists of the igniter button, electrode and wire. The pilot is ignited by an electric spark generated when the igniter button is pressed. The electrode should be centered between the pilot and thermocouple (Figure 23). Use only factory authorized piezoelectric igniter parts for replacement.

### Testing the Igniter System

Turn off the gas to the water heater at the manual gas shut-off valve. Watch the electrode tip while activating the igniter. A visible spark should jump from the electrode. To avoid shock, do not touch the burner or any metal part on the pilot or pilot assembly. If no spark is visible, check the wire connections and make sure the electrode is not broken. Replace the electrode if defective. Note: The electrode is part of the pilot assembly and cannot be replaced separately. Dirt and rust on the pilot or electrode tip can prevent the igniter spark. Wipe clean with a damp cloth and dry completely. Rust can be removed from the electrode tip and metal surfaces by lightly sanding with an emery cloth or fine grit sandpaper.

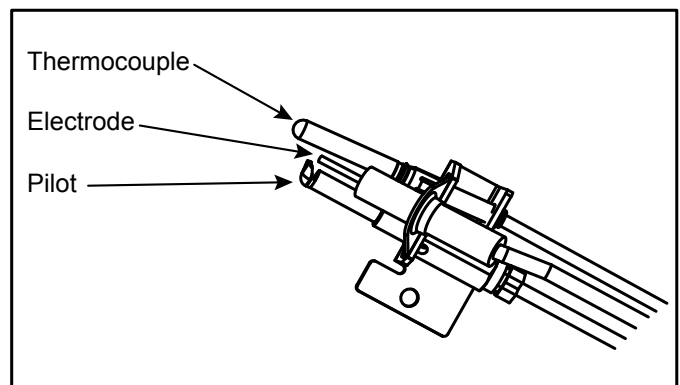

**FIGURE 23**

## Removing and Replacing the Gas Control Valve/Thermostat:

**IMPORTANT:** The gas control valve/thermostat is a standard valve with a right hand thread thermocouple. Use only factory authorized replacement parts.

### Removing the Gas Valve:

1. Turn the gas control knob on the combination gas control valve/thermostat clockwise to the "OFF" position. See "Lighting Instructions" on water heater.
2. Turn off the gas at the manual shut-off valve on the gas supply pipe (Figure 1).
3. Drain the water heater. Refer to the "Draining and Flushing" section and follow the procedure.
4. Disconnect the igniter wire from the igniter. Note: There are two types of igniters. If you have the round igniter, first remove the igniter from the bracket by depressing front and rear holding tabs and lift. Next remove igniter bracket from the gas valve. If you have the square igniter slide the igniter bracket backwards away from the gas valve to remove it. Disconnect the thermocouple (right-hand threads), pilot tube and manifold tube at the gas control valve/thermostat (Figure 21).
5. Refer to "Gas Piping" section (Figure 14) and disconnect the ground joint union in the gas piping. Disconnect the remaining pipe from the gas control valve/thermostat.

6. To remove the gas control valve/thermostat, thread a correctly sized pipe into the the inlet and use it to turn the gas valve (counterclockwise). Do not use a pipe wrench or equivalent to grip body. Damage may result causing leaks. Do not insert any sharp objects into the inlet or outlet connections. Damage to the gas control valve/thermostat may result.

### Replacing the Gas Valve:

To replace the gas control valve/thermostat, reassemble in reverse order. When replacing the gas control valve/thermostat, thread a correctly sized pipe into the inlet and use it to turn the gas control valve/thermostat (clockwise). **DO NOT OVERTIGHTEN**, damage may result.

- Be sure to use approved Teflon® tape or pipe joint compound on the gas piping connections and fitting on the back of the gas control valve/thermostat that screws into the tank.
- Be sure to remove the pilot ferrule nut from the new gas control valve/thermostat.
- Turn the gas supply on and check for leaks. Test all connections by brushing on an approved noncorrosive leak-detection solution. Bubbles will show a leak. Correct any leak found.
- Be sure tank is completely filled with water before lighting and activating the water heater. Follow the "Lighting Instructions".
- If additional information is required, contact the Service Department at: 1-877-817-6750

TEFLON® is a registered trademark of E.I. Du Pont De Nemours and Company.

## Operational Checklist

1. Burner door gasket properly sealed.
2. Viewport not damaged or cracked.
3. No leaks at pilot and manifold connection.
4. Burner door screws securely tightened.

## Flue Baffle Installation:

For 100 gallon unit, baffle tab extensions should be oriented toward the outside of the heater when installed correctly. Refer to Figure 24 for correct placement of baffles.

For 75 gallon unit, baffle tabs (one each near the top of each baffle) should be oriented toward the inside of the heater when installed correctly. Refer to Figure 25 for correct placement of baffles.

**NOTE:** Do not operate this water heater unless the baffles are installed correctly. Failure to do so can result in poor combustion and high flue gas temperatures.

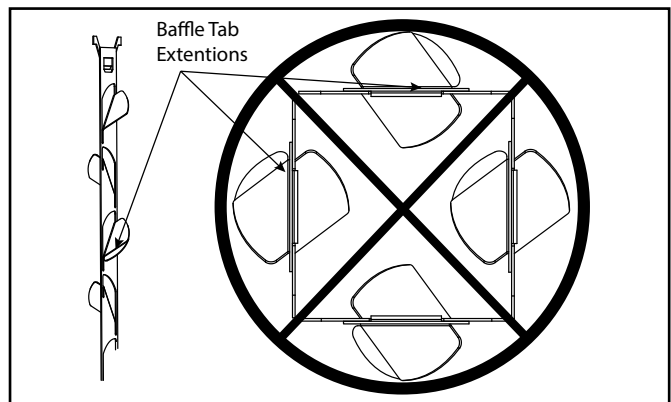

FIGURE 24

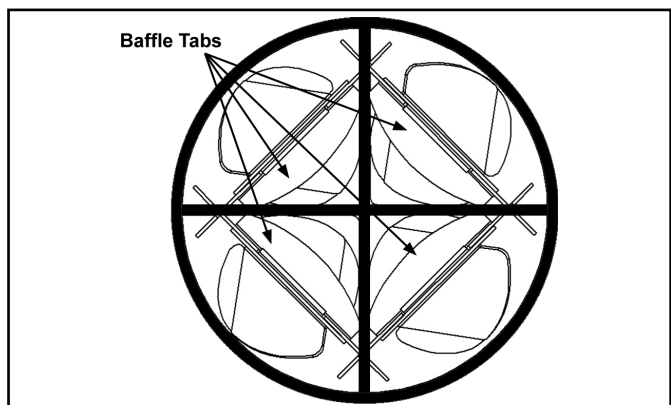
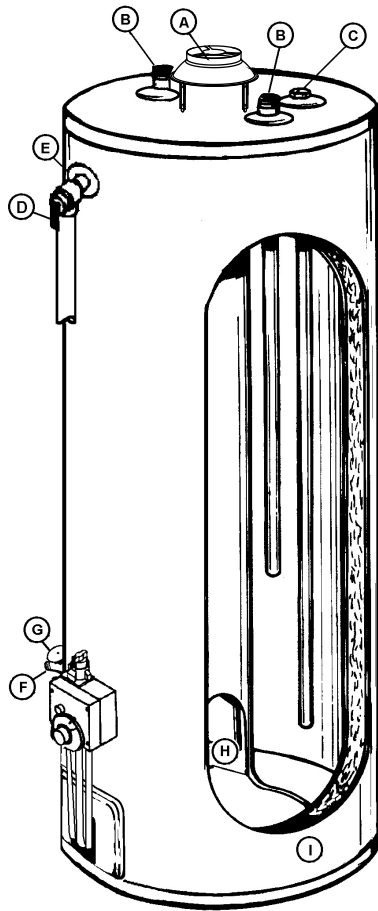

FIGURE 25

# LEAKAGE CHECKPOINTS



Read this manual first. Then before checking the water heater make sure the gas supply has been turned “OFF”, and never turn the gas “ON” before the tank is completely full of water.

Never use this water heater unless it is completely filled with water to prevent damage to the tank. Water must flow from the hot water faucet before turning “ON” gas to the water heater.

- A. Water at the draft hood is water vapor which has condensed out of the combustion products. This is caused by a problem in the vent. Contact a qualified service technician.
- B. \*Condensation may be seen on pipes in humid weather or pipe connections may be leaking.
- C. \*The anode rod fitting may be leaking.
- D. Small amounts of water from temperature-pressure relief valve may be due to thermal expansion or high water pressure in your area.
- E. \*The temperature-pressure relief valve may be leaking at the tank fitting.
- F. Water from a drain valve may be due to the valve being slightly opened.
- G. \*The drain valve may be leaking at the tank fitting.
- H. Combustion products contain water vapor which can condense on the cooler surfaces of the tank. Droplets form and drip onto the burner or run on the floor. This is common at the time of start-up after installation and when incoming water is cold.
- I. Water in the water heater bottom or on the floor may be from condensation, loose connections, or the relief valve. DO NOT replace the water heater until a full inspection of all possible water sources is made and necessary corrective steps taken.

Leakage from other appliances, water lines, or ground seepage should also be checked.

- \* To check where threaded portion enters tank, insert cotton swab between jacket opening and fitting. If cotton is wet, follow “Draining” instructions in the “Periodic Maintenance” section and then remove fitting. Put pipe dope or teflon tape on the threads and replace. Then follow “Filling the Water Heater” instructions in the “Installing the New Water Heater” section.



**⚠ WARNING**

Read and understand instruction manual and safety messages before installing, operating or servicing this water heater.

Failure to follow instructions and safety messages could result in death or serious injury.

Instruction Manual must remain with water heater.

# REPAIR PARTS

Key No.	Part Description
1	Pipe Nipple
2	Burner Tube
3	Burner Head
4	Thermocouple
5	Pilot
6	Draft Hood
7	Inlet Tube
8	Flue Baffle Assembly
9	Anode Rod
10	Outer Door
11	Gas Control Valve/Thermostat
12	T & P Relief Valve
13	Drain Valve
14	Pilot Tube
15	Orifices
*16	Metal Drain Pan
*17	Instruction Manual

\* Not Shown.

Now that you have purchased this water heater, should a need ever exist for repair parts or service, simply contact the company it was purchased from or direct from the manufacturer listed on the rating plate on the water heater.

Be sure to provide all pertinent facts when you call or visit.

**Selling prices will be furnished on request or parts will be shipped at prevailing prices and you will be billed accordingly.**

The model number of your Gas Water Heater will be found on the rating place located above the gas control valve.

WHEN ORDERING REPAIR PARTS, ALWAYS GIVE THE FOLLOWING INFORMATION:

- MODEL NUMBER
- TYPE GAS (NATURAL)
- SERIAL NUMBER
- PART DESCRIPTION

**THIS IS A REPAIR PARTS LIST, NOT A PACKING LIST.**

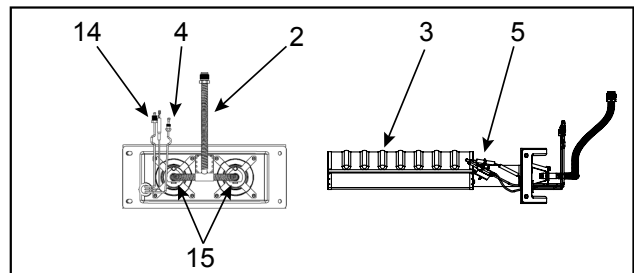
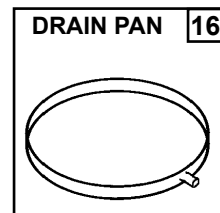
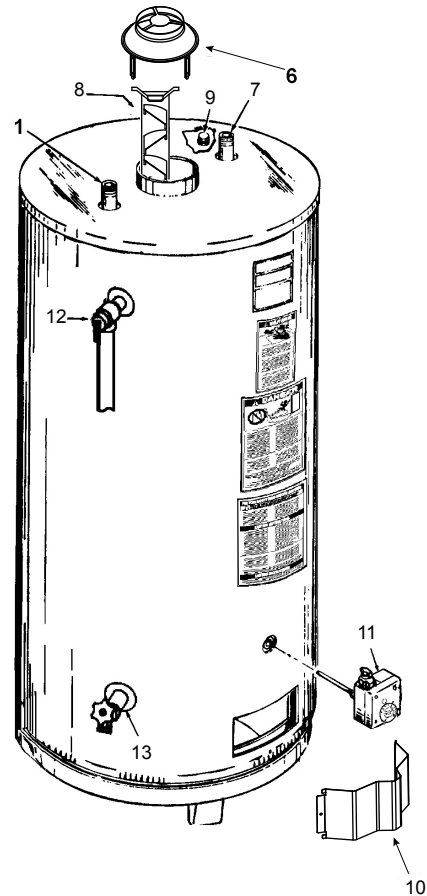

**3/4" T&P RELIEF VALVE**  
AUTOMATIC, SELF-CLOSING TYPES

<b>PRESS</b>	<b>A=</b>	<b>TEMP RELIEF</b>
<b>150 LBS.</b>	<b>2.13"</b>	<b>210°F</b>

# TROUBLESHOOTING GUIDELINES

These guidelines should be utilized by a qualified service agent.

Problem	Cause	Solution
<b>WATER LEAKS</b>	Improperly sealed, hot or cold supply connection, relief valve, or thermostat threads.	Tighten thread connections.
	Leakage from water lines.	Inspect water lines and connections.
	Condensation of flue products.	Refer to "Condensation" section.
<b>LEAKING T&amp;P VALVE</b>	Thermal expansion in closed water system.	Install thermal expansion tank (DO NOT plug T&P valve).
	Improperly seated valve.	Check relief valve for proper operation. Replace if necessary. (DO NOT plug T&P valve).
<b>SMELLY WATER</b>	High sulfate or mineral content in water supply.	Drain and flush water heater thoroughly, then refill.
	Bacteria in water supply.	Chlorinate or aerate water supply.
<b>PILOT WILL NOT LIGHT</b>	Gas control knob not positioned correctly.	Refer to "Lighting Instructions".
	Main gas supply off.	Turn off main gas shut-off valve.
	Ignitor wire not connected.	Check ignitor wire connection.
	Faulty ignitor.	Replace ignitor.
	Air in gas line	Bleed the air from the gas line
	Dirt in gas line	Notify utility-install dirt trap in gas line
	Pilot line or orifice clogged	Clean, locate source and correct
	Cold drafts	Locate source and correct
	Thermostat ECO switch open	Replace thermostat
	Low gas pressure	Check with gas utility company
	Combustion air obstructed	See maintenance section for inspection and cleaning of burner
	Pilot dirty	Clean pilot
	<b>BURNER WILL NOT STAY LIT</b>	Thermocouple malfunction.
Defective gas control.		Replace Gas Control
Pilot not lit		Light pilot
Thermostat set too low		Turn temp. dial to desired temperature
No gas		Check with gas utility company
Dirt in the gas lines		Notify utility-inatall trap in gas line
Pilot line clogged		Clean, locate source and correct
Main burner line clogged		Clean, locate source and correct
Non-functioning thermostat		Replace thermostat
Heater installed in a confined area		Provide fresh air ventilation
<b>PILOT OUTAGE</b>	Thermocouple tip is not in contact with pilot flame.	Insert thermocouple correctly.
	Dirty pilot burner.	Clean pilot assembly.
	Thermocouple malfunction.	Replace pilot assembly and/or thermocouple.
	Defective gas control.	Replace gas control.
<b>NO HOT WATER</b>	Pilot not lit or thermostat not on.	Refer to "Lighting Instructions".
<b>NOT ENOUGH HOT WATER</b>	Thermostat set too low.	Refer to "Temperature Regulation"
	Low gas pressure.	Contact your gas supplier.
	Incoming water is unusually cold.	Allow more time for water heater to re-heat.
	Leaking hot water pipes or fixtures.	Have plumber to check and repair leaks.
	High temperature limit switch activated.	Contact a service agency to determine cause.
	Heater undersized.	Reduce hot water usage.
<b>WATER TOO HOT</b>	Thermostat set too high.	Refer to "Temperature Regulation".
<b>WATER HEATER SOUNDS</b>	Condensation dripping on burner.	Refer to "Condensation".
<b>SIZZLING OR RUMBLING SOUND</b>	Sediment or calcium in bottom of tank.	Clean sediment from tank. Refer to "Draining" instructions in the maintenance section of manual.
<b>SOOTING</b>	Improper combustion.	No adjustment available. Contact a service agency to determine cause.
<b>VENT GAS ODORS</b>	Lack of sufficient supply air	Contact a qualified service agency to determine cause.
	Improperly installed vent piping.	
	Downdraft.	
	Poor combustion.	

# NOTES

# NOTES

**®Teflon is a registered trademark of E.I. Du Pont De Nemours and Company  
A.O. Smith Corporation. All Rights Reserved.  
Limited Warranty provided by Manufacturer.**