

# Mantis<sup>®</sup>

## Tiller/Cultivator



**MODEL 7920**

**MODEL 7924**

**MAN 430088**

Rev. B 9-16-14

**Operator's Manual and Safety Instructions for  
Tiller/Cultivator**

**OPERATOR'S/PARTS MANUAL**



# Welcome to the World of Mantis Gardening

Here's your new MANTIS Tiller . . . the lightweight wonder that's Changing the Way Americans Garden.®

Unlike big tillers, your MANTIS Tiller weighs only 20 lbs. (Model 7920) and 22.5 lbs. (Model 7924). So it lifts easily, handles smoothly, tills and weeds precisely. And, unlike other small tillers, it features serpentine tines that churn soil to ten inches deep. It creates a soft, smooth seed bed, even in problem soil.

Once you know how to use your tiller correctly, we guarantee you'll love it. So first, please read this manual. It shows, step by step, how to use your tiller safely.

**ATTENTION MANTIS PRODUCT OWNERS!**  
Get maintenance tips for your Mantis product on our web site at [www.mantis.com](http://www.mantis.com)

## IMPORTANT MESSAGE

Thank you for purchasing this Schiller Grounds Care, Inc. product. You have purchased a world class product, one of the best designed and built anywhere.

This machine comes with Operation and Safety instructions, Parts and Service instructions and Engine instructions. The useful life and good service you receive from this machine depends to a large extent on how well you read and understand these manuals. Treat your machine properly, lubricate and adjust it as instructed, and it will give you many years of reliable service.

Your safe use of this Schiller Grounds Care, Inc. product is one of our prime design objectives. Many safety features are built in, but we also rely on your good sense and care to achieve accident-free operation. For best protection, study the manuals thoroughly. Learn the proper operation of all controls. Observe all safety precautions. Follow all instructions and warnings completely. Do not remove or defeat any safety features. Make sure those who operate this machine are as well informed and careful in its use as you are.

See a Schiller Grounds Care, Inc. dealer for any service or parts needed. Schiller Grounds Care, Inc. service ensures that you continue to receive the best results possible from Schiller Grounds Care, Inc. products. You can trust Schiller Grounds Care, Inc. replacement parts because they are manufactured with the same high precision and quality as the original parts.

Schiller Grounds Care, Inc. designs and builds its equipment to serve many years in a safe and productive manner. For longest life, use this machine only as directed in the manuals, keep it in good repair and follow safety warnings and instructions. You'll always be glad you did.

**Schiller Grounds Care, Inc.**  
1028 Street Road  
Southampton, PA 18966-4217  
PHONE (800) 366-6268 • FAX (215) 956-3855

## TABLE OF CONTENTS

SAFETY RULES & WARNINGS	FUELING & STARTING
Special Safety Information..... 3	2-Cycle Fueling..... 10
Safety & Warnings ..... 3	2-Cycle Tiller Starting ..... 11-12
Safety Decal Information ..... 3	OPERATION..... 13-14
Warning Dos ..... 4	TRANSPORT ..... 15
Warning Don'ts ..... 5	STORAGE ..... 15
Engine/Fuel Warning Do's ..... 5	MAINTENANCE ..... 16-18
Engine/Fuel Warning Don'ts ..... 5	TROUBLESHOOTING ..... 19
ASSEMBLY ..... 6	MANTIS TILLER ASSEMBLIES ..... 20-24
Lower Handle ..... 7	CONTROL ..... 25
Upper Handle Assembly ..... 8	EPA..... 26
Tines ..... 8-9	LIMITED WARRANTY INFORMATION ..... BACK PAGE
Kickstand ..... 9	



This Operator's / Parts Manual is part of the machine. Suppliers of both new and second-hand machines must make sure that this manual is provided with the machine.

## Safety Rules & Warnings

You will notice throughout this Operator's Manual Safety Rules and Important Notes. Make sure you understand and obey these warnings for your own protection.

### I. SPECIAL SAFETY INFORMATION

**! WARNING**

Attention: This symbol points out our important safety instructions. When you see this symbol, **!** heed it's warning!! Stay alert!!

**! WARNING**

To reduce the potential for accidents, comply with the safety instructions in this manual. Failure to comply may result in serious personal injury, and/or equipment and property damage.

### II. SAFETY & WARNINGS

**! WARNING**

Improper use or care of this tiller or failure to wear proper protection can result in serious injury. Read and understand the rules for safe operation and all instructions in this manual. Wear hearing and eye protection.

**! WARNING**

The engine exhaust from this product contains chemicals known to the State of California to cause cancer, birth defects or other reproductive harm.

### III. SAFETY DECAL INFORMATION

An important part of the safety system incorporated in this tiller are the warning and information decals found on various parts of the tiller. These decals must be replaced in time due to abrasion, etc. It is your responsibility to replace these decals when they become hard to read.



P/N 400630



P/N 430057

**EMISSION CONTROL INFORMATION**  
 ENGINE FAMILY: Z49EHXS.0454KA DISPLACEMENT: 45.0cc  
 EMISSION COMPLIANCE PERIOD = 300 HOURS  
 THIS ENGINE MEETS U.S. EPA EXH/EVP REGS FOR MODEL YEAR 2022  
 REFER TO OWNER'S MANUAL FOR MAINTENANCE SPECIFICATIONS AND ADJUSTMENTS.  
**YAMABIKO CORP.**

An Emission Control Label is located on the engine (This is an EXAMPLE ONLY, information on label varies by engine FAMILY.)

**PRODUCT EMISSION DURABILITY**  
 The 300 hour emission durability compliance period is the time span selected by the manufacturer certifying the engine emissions output meets applicable emissions regulations, provided that approved maintenance procedures are followed as listed in the Maintenance Section of this manual.



Cutting hazard; keep feet and hands away from rotating tines.



Do not carry the tiller in this position.



Read operators manual before using tiller, or performing any repair or maintenance. Keep operators manual in a safe place.



Caution: when assembling the handles, make sure fuel tank faces operator. This is the rear of the tiller, refer to assembly instructions



Incorrect assembly.



Don't fuel, refuel, or check fuel while smoking, or near an open flame or other ignition source.



Wear ear and eye Protection.



Don't operate indoors



Mix unleaded gas with 2 cycle 50:1 oil.

## WARNING

If the tiller is used improperly or safety precautions are not followed, the users risk serious injury to themselves and others.  
Read and understand this manual before attempting to operate this tiller.

## WARNING

Operation of this equipment may create sparks that can start fires around dry vegetation. A spark arrestor is installed. The operator should contact local fire agencies for laws or regulations relating to fire prevention requirements.

### IV. WARNINGS - DOS

Read and understand the owner's manual. Pay particular attention to all sections regarding safety.

1. **Always** keep a firm grip on both handles while the tines are moving and/or the engine is running. **BE AWARE!!** The tines may coast after throttle trigger is released. Make sure tines have come to a complete stop and engine is off before letting go of the tiller.
2. **Always** maintain a firm footing and good balance. Do not overreach while operating the tiller. Before you start to use the tiller check the work area for obstacles that might cause you to lose your footing, balance or control of the machine.
3. **Thoroughly** inspect the area where equipment is to be used and remove all objects, which can be thrown by the machine.
4. **Always** keep area clear of children, pets, and bystanders.
5. **Always** stay alert. Watch what you are doing and use common sense. Do not operate unit when fatigued.
6. **Always** dress properly. Do not wear loose clothing or jewelry, they might get caught in moving parts. Use sturdy gloves. Gloves reduce the transmission of vibration to your hands. Prolonged exposure to vibration can cause numbness and other ailments.
7. **While working**, always wear substantial footwear and long trousers. Do not operate the equipment when barefoot or wearing open sandals.
8. **Always** wear ear and eye protection. Eye protection must meet applicable CE requirements. To avoid hearing damage, we recommend hearing protection be worn whenever using the equipment.
9. **To reduce fire hazard**, keep the engine, and petrol/gas storage area free of vegetative material and excessive grease.
10. **Start** the engine carefully, according to the manufacturer's instructions and with feet well away from tool(s).
11. **Keep** all nuts, bolts and screws tight to be sure the equipment is in safe working condition.
12. **Use extreme caution** when reversing or pulling the machine towards you.
13. **Work only** in daylight or good artificial light.
14. **Always** be sure of your footing on slopes.
15. **Exercise** extreme caution when changing direction on slopes.
16. **Always** keep a safe distance between two or more people when working together.
17. **Always** inspect your unit before each use. Keep all knobs, nuts, bolts and screws tight to be sure the equipment is in safe working condition.
18. **Always** visually inspect to see that the tools are not worn or damaged. Before using your tiller, replace worn or damaged elements and bolts in sets to preserve balance.
19. **Always** maintain and examine your Tiller with care. Follow maintenance instructions given in manual.
20. **Always** store tiller in a sheltered area (a dry place), not accessible to children. The tiller as well as fuel should not be stored in a house.
21. **Always** keep in mind that the operator or user is responsible for accidents or hazards occurring to other people or their property.

## Safety Rules & Warnings

### V. WARNINGS - DON'TS

**Don't** use tiller with one hand. Keep both hands on handles with fingers and thumbs encircling the handles, while tines are moving, and engine is running.

**Don't** run with the machine, walk.

**Don't** work on excessively steep slopes.

**Don't** attempt to clear tines while they are moving. Never try to remove jammed

material before switching the engine off and making sure the tines have stopped completely.

**Don't** allow children or people unfamiliar with these instructions to use the machine. Local regulations can restrict the age of operator.

**Don't** let others operate tiller without proper training.

**Don't** operate while under the influence of alcohol or drugs.

**Don't** attempt to repair this tiller. Have repairs made by a qualified dealer or repairman. See that only original Mantis parts are used.

**Don't** overreach. Keep a good footing at all times.

**Don't** stand in front of tiller when tines are rotating.

### WARNING

Handle fuel with care, it is highly flammable. Fueling a hot engine or near an ignition source can cause a fire and result in serious personal injury and/or property damage.

### VI. ENGINE/FUEL WARNINGS - DOS

**Always** use fresh gasoline in the fuel mixture. Stale gasoline can cause damage.

**Always** store fuel in containers specifically designed for this purpose.

**Always** add fuel before starting the engine.

**Always** replace all fuel tank and

container caps securely.

**Always** pull starter cord slowly until resistance is felt to avoid kickback and prevent arm or hand injury.

**Always** operate engine with spark arrestor installed and operating properly.

**Stop** the engine whenever you leave the machine and before refueling. Allow the engine to cool before storing in any enclosure. Replace worn or damaged parts for safety.

**If** the fuel tank needs to be drained, this should be done outdoors.

### VII. ENGINE/FUEL WARNINGS - DON'TS

**Never** pick up or carry a machine while the engine is running.

**Don't** fuel, refuel or check fuel while smoking, or near an open flame or other ignition source. Stop engine and be sure it is cool before refueling.

**Don't** leave the engine running while the tiller is unattended. Stop the engine when carrying out maintenance and cleaning operations, when changing tools and when being transported by means other than under its own power.

**Never** remove the cap of the fuel tank or add fuel while the engine is running or when the engine is hot.

**Don't** refuel, start or run this tiller indoors or in an improperly ventilated area.

**Don't** run engine when electrical system

causes spark outside the cylinder. During periodical checks of the spark plug, keep plug a safe distance from cylinder to avoid burning of evaporated fuel from cylinder.

**Don't** check for spark with spark plug or plug wire removed. Use an approved tester.

**Don't** crank engine with spark plug removed unless spark plug wire is disconnected. Sparks can ignite fumes.

**Don't** run engine when the odor of gasoline is present or other explosive conditions exist.

**Do not** attempt to start the engine if fuel is spilled, but move the machine away from the area of spillage and avoid creating any source of ignition until fuel vapors have dissipated.

**Don't** operate your tiller if there is an accumulation of debris around the muffler, and cooling fins. To reduce the fire hazard, keep the engine and fuel storage area free of vegetative material and excessive grease.

**Don't** touch hot mufflers, cylinders or cooling fins as contact may cause serious burns.

**Don't** change the engine governor setting or over speed the engine.

**Don't** attempt to remove spark plug while engine is hot. Removing a spark plug from a hot engine can cause irreparable damage to the engine and will void your warranty.

**Don't** use starter fluids as they will cause permanent engine damage.

# Assembly

Picture of Model 7920

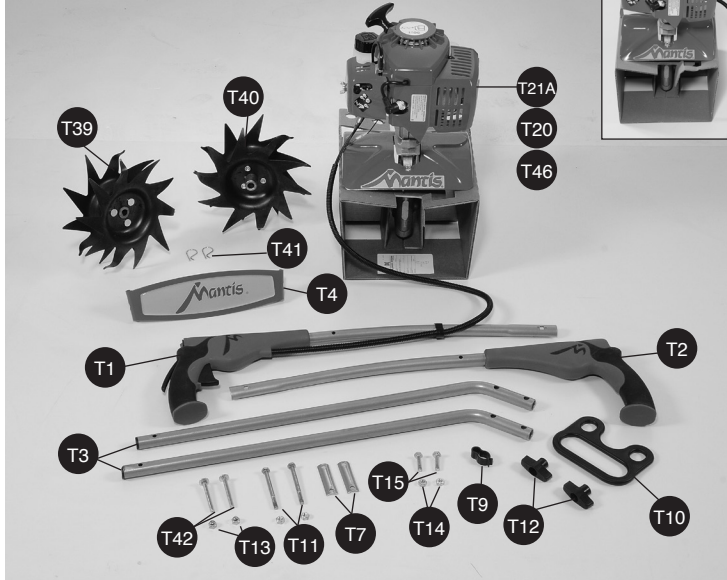

Picture of Model 7924

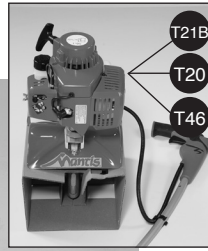

**⚠ WARNING**

Improper assembly of this tiller can result in serious injury. Make sure to follow all instructions carefully. If you have any questions, contact our factory at 1-800-366-6268 or an authorized Mantis dealer.

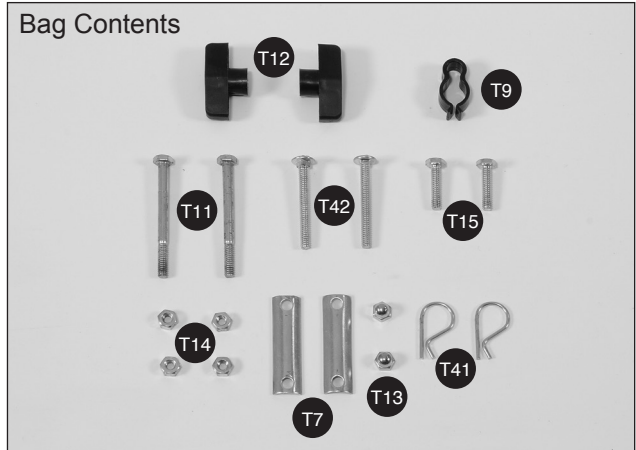

## WHAT COMES IN THE BOX

Key	Qty.	Part No.	Description
T1	1		Upper Handle Throttle Side Assembly
T2	1		Upper Handle Assembly, Left
T3	2		Lower Handles W/Plug
T4	1		Handle Brace Assembly
T10	1		Plastic Carrying Handle
T21A, T20, T46	1		Engine Assembly (includes Fender Guard & Worm Gear Transmission) (model 7920)
T21B, T20, T46	1		Engine Assembly (includes Fender Guard & Worm Gear Transmission) (model 7924)
T39/T40	1		Pair Tiller/Cultivator Tines
	1		Bag of Hardware Containing
T7	2		Handle Clamps
T9	1		Throttle Clip
T11	2		Bolts (3" long)
T12	2		Knobs
T13	2		Acorn Nuts
T14	4		Lock Nuts
T15	2		Cap Screws
T41	2		Tine Retaining Pins
T42	2		Carriage Bolts
T49	1		Kickstand, Stand Assembly (model 7924)
T50	1		Kickstand, Bracket and Hardware Bag (model 7924)
Not Shown	1	451	2-Cycle Oil



## WHAT YOU WILL NEED TO ASSEMBLE THE TILLER

Prior to removing the contents and assembling, it is important to:

- Have a clean work area.
- You will need two 7/16" wrenches
- Make sure all necessary tools are handy.
- A 3/8" wrench for kickstand assembly

## Assembly

### LET'S BEGIN

- With the box upright, open the box and remove the tine box and the loose parts that are at the top of the tiller box. Do not remove any other parts in the box.
- Lay the box on one side and open the bottom flaps.
- Return the box to an upright position (as shown) and pull the box straight up.
- Leave the engine and throttle handle in the cradle to assist in the assembly.
- Lay everything out so you can easily identify the parts (see parts image and list on page 6).



**NOTE:** Some of the photos in this manual do not represent your tiller engine. They are for assembly purposes only.

### LOWER HANDLE ASSEMBLY

To identify part numbers see page 6.



- For ease of assembly and stability it is important that you keep the engine assembly in its cardboard cradle.

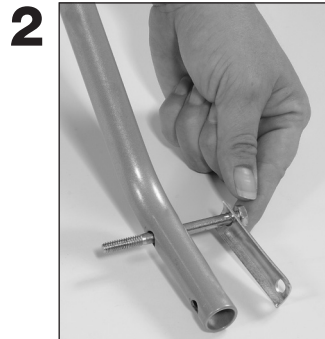

- Lay the handle parts within easy reach. You'll need one of the handle clamps (T7) and one of the lower handles (T3). Note that the lower handles have a short leg on one end.
- Fit the handle clamp along the outside of the short leg. Line up the holes on the clamp and the leg.



- Choose one of the two 3-inch bolts (T11). Slide it through the first set of holes — near the elbow where the lower handle curves. (Pictures 2 & 3)
- Now slide the other lower handle onto the 3-inch bolt. Fit the other clamp onto the other handle's short leg. Add a lock nut (T14) and tighten finger tight. (Picture 3)

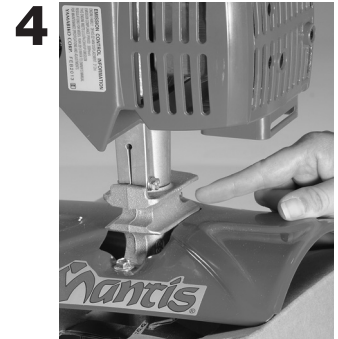

- Locate recessed channels below the engine.



- Take the lower handles that you've just put together. Slide them into the two recessed channels.
- Make sure you insert them from the rear of the tiller (**gasoline tank faces the operator**)... so that the bolt fits along the back of the housing.



- Slide the second 3-inch bolt (T11) through the second set of holes in the short legs. Add a lock nut (T14) and tighten finger tight until you've completed assembly.

**NOTE:** THE LOCK NUTS ARE STAMPED. FINGER TIGHT IS APPROXIMATELY 1/2 TO 1-1/2 TURNS UNTIL YOU'VE COMPLETED ASSEMBLY.

## Assembly (Continued)

### UPPER HANDLE ASSEMBLY



- Lightly squeeze the lower handles (T3) toward one another so that they line up with the two smaller holes on the carrying handle (T10). Then slide the carrying handle over and down the lower handles. It will rest about four to six inches above the fender.
- Gently pull the lower handles out to their original position.

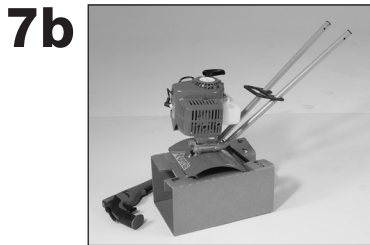

- Your Mantis Tiller will look like this when the lower handle assembly is complete.

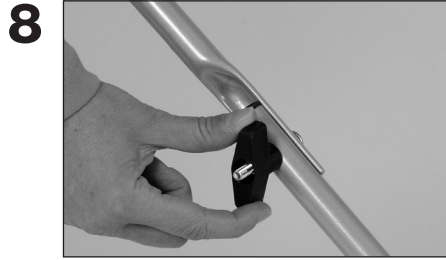

- Lift the upper handle until it lines up with the lower handle.
- Insert carriage bolt (T42) from outside in.
- Screw on knob (T12) and fully tighten the knob at the pivot point.

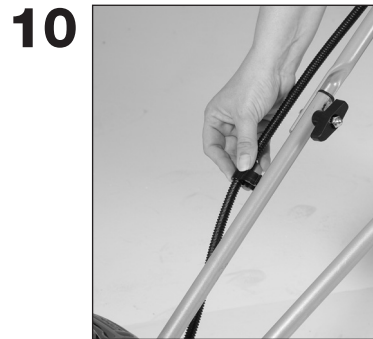

- Follow the same steps to install the other upper handle onto the other lower handle.
- Use the clip (T9) to secure the throttle cable and wire in place on the lower handle.



- Cap the exposed bolt with an acorn nut (T13) and tighten with your 7/16" wrench until snug. Do not over tighten.



- Now install the handle brace. Line it up with the holes on the upper handles. Then insert a cap screw (T15) and a lock nut (T14) on either side.
- Use a wrench to tighten cap screws and lock nuts.
- Now use wrench to tighten all nuts and bolts firmly and securely.

### TINE ASSEMBLY

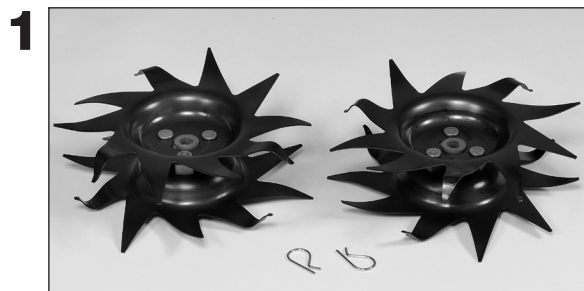

- You'll need the 2 Tines and the 2 retaining pins.

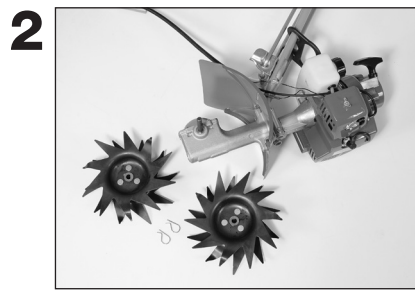

- Remove the unit from the cardboard cradle and lay the unit on its side.



- You will notice that one side of the Tine has a circular hole while the other has a "D" shaped hole.



### TINE ASSEMBLY (Continued)

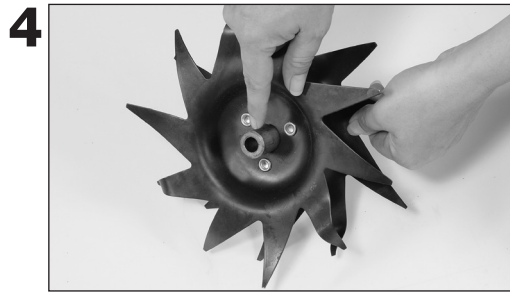

- Attach the Tine so that the circular hole slides onto the axle first.

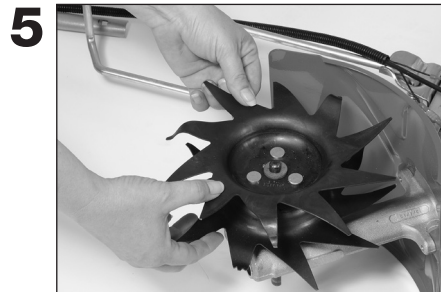

- When the axle protrudes from the other side it will line up perfectly with the "D" shaped hole.



- Slide a retaining pin (T41) through the hole in the axle to secure the Tine.
- Repeat steps for the other side.

### KICKSTAND ASSEMBLY (MODEL 7924 ONLY)

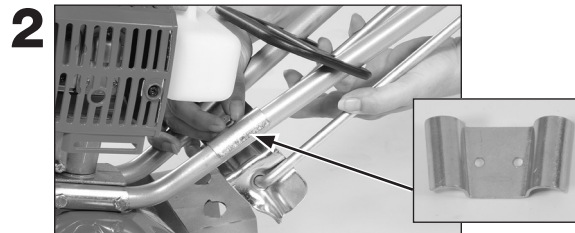

- Position the kickstand brace just above the bend of the lower handles.
- Position the kickstand under the lower handles, line up the holes and thread the kickstand brace bolts into the kickstand.
- Tighten with the 3/8" wrench.

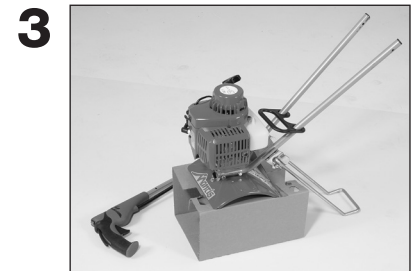

- Your Mantis tiller will look like this when lower handle assembly and kickstand is complete.



**IMPORTANT NOTE:**  
Make sure you have installed the handles properly. When you stand behind your tiller, holding the handles, the fender warning label should face you.

**IMPORTANT NOTE:**  
Before you use your MANTIS Tiller, read the Safety Rules & Warnings on pages 3-5

**IMPORTANT NOTE:**  
Be sure you have proper throttle movements and that the throttle cable is not wrapped or twisted around the handle bar. Hold down the lockout lever, fully squeeze the throttle trigger and let go. The throttle triangle must click in both directions. If there is any doubt, remove air filter and visually check that the throttle triangle hits both the idle screw and the full open stop. **THIS MUST BE DONE BEFORE STARTING THE ENGINE.**

**⚠ WARNING**  
Improper Throttle installation can cause tines to rotate unexpectedly.



## 2-Cycle Tiller Fueling

### 2-CYCLE TILLER FUELING

#### MIXING FUEL

Use a mixture of 50 parts unleaded regular gasoline and 1 part two-stroke MANTIS oil (50:1.) Use branded 89 octane (R+M+2) unleaded gasoline (maximum 10% ethanol, or 15% MTBE, no methyl alcohol.)



Here's how to mix the oil with the gas:

1. Pour 1/2 of the gasoline into a safe container. **Do not mix the fuel and oil in the engine fuel tank.**
2. Add 2.6 ounces of two-cycle engine oil to the gasoline and mix. The bottle is measured exactly to 2.6 ounces. Then add the rest of the gasoline.
3. Screw the cap onto the gasoline can. Then swirl the can to blend the oil and gas.
4. Carefully pour the fuel mix into the tiller's fuel tank. After putting the fuel tank's cap back on, wipe up any spilled fuel from tank and gasoline can.

**Need more pre-measured engine oil? You can order it directly from Mantis or your local authorized Mantis dealer. Just call toll free 1-800-366-6268 and ask for our Sales Dept.**

#### IMPORTANT:

Two stroke fuel separates and ages. Do not mix more than you will use in a month. Using old fuel can cause difficult starting or engine damage. Shake fuel container to thoroughly mix fuel before each use.

#### Remember ...

- **Never**, run your tiller on gasoline alone. This will ruin your engine and void all warranties.
- **Always** use a clean gas can and always use unleaded gas.
- **Never** try to mix the oil and gasoline in the engine fuel tank.
- **Always** mix oil and gas in the proper proportions: 2.6 ounces of two-cycle engine oil to one gallon of unleaded gasoline.

#### IMPORTANT NOTE:

**Do Not use old or stale oil/gasoline mixture.** Always use the proper oil/gasoline mixture. If you do not, your engine will suffer rapid, permanent damage. And you will void the engine warranty.

### ⚠ WARNING • DANGER ⚠

ALTERNATIVE FUELS, SUCH AS E-15 (15% ETHANOL), E-85 (85% ETHANOL) OR ANY FUELS NOT MEETING ECHO REQUIREMENTS ARE NOT APPROVED FOR USE IN ECHO 2-STROKE GASOLINE ENGINES. USE OF ALTERNATIVE FUELS MAY CAUSE PERFORMANCE PROBLEMS, LOSS OF POWER, OVERHEATING, FUEL VAPOR LOCK AND UNINTENDED MACHINE OPERATION, INCLUDING, BUT NOT LIMITED TO, IMPROPER CLUTCH ENGAGEMENT. ALTERNATIVE FUELS MAY ALSO CAUSE PREMATURE DETERIORATION OF FUEL LINES, GASKETS, CARBURETORS AND OTHER ENGINE COMPONENTS.

#### ⚠ WARNING

Do not operate the engine in a confined space where dangerous carbon monoxide fumes can collect.

#### ⚠ WARNING

Fuel is extremely flammable. Handle it with care. Keep away from ignition sources. Do not smoke while fueling your equipment

#### ⚠ WARNING

Avoid accidental blade engagement. Do not squeeze the throttle trigger when starting. Maintain proper idle speed adjustment (2500-3100 rpm)

## 2-Cycle Tiller Starting

### 2-CYCLE TILLER STARTING

1. Fill the fuel tank with the proper oil/gasoline mixture. (See previous section.)
2. Hand tighten the gasoline cap just until it's snug.
3. Place the O/I switch into the I "start/on" position. (Picture 1)
4. Pull the choke button all the way out, to completely close the choke. (Picture 2)
5. Locate the purge bulb on the upper right of the engine, in front of the fuel tank. (See Picture 3) It sends fuel into the carburetor, for easy starting. Press the purge bulb until you see fuel flow through the clear fuel return line. Since you're starting "cold," you may need to press six to eight times. As soon as fuel starts flowing through the clear fuel line, stop pressing!
6. Recoil pull starting (Different for each model)

Picture 1



Switch



Picture 2



Choke

Picture 3



**NOTE: Don't press the throttle trigger during the starting of the engine.**

#### FOR MODEL 7920:

Pull the recoil starter handle/rope (Picture 4A) with a controlled motion until resistance is felt. Then give the cord a few brisk pulls until the engine fires. During cold starting, you may need to try three or four times before the engine fires. Do not pull the rope out to end stop and do not let it snap back into the starter housing.



Picture 4A

#### FOR MODEL 7924 (Fast starting engine option):

Fast starting system significantly reduces the effort required to start the engine. Energy is stored in the starter spring each time the handle/rope is pulled.

Slowly pull the recoil starter handle/rope (Picture 4B) to wind up the spring. You will hear light clicking and then the sound of the released spring. Generally during cold starting, you may need two to four light pulls before the engine fires.

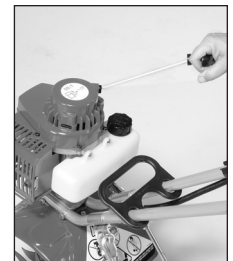

Picture 4B

**NOTE: DO NOT PULL THE CORD MORE THAN 4 TIMES WHEN THE CHOKE IS CLOSED. OVER PULLING MAY CAUSE ENGINE FLOODING!**

Bear in mind that, when the engine fires, it only coughs or sputters, and will not run on choke.

7. Push the choke button in, all the way, to open the choke.
8. Then pull the starter cord again until engine starts and runs.

Let the engine warm up two to three minutes before using

NOTE: If engine does not start with choke in "Run" position after 5 engine engagements, repeat Cold Start instructions.

### WARM STARTING

- To start a warm engine, follow the same procedure. The only exception is that you can leave the choke button in and you don't have to pump the primer bulb.
- Before using the tiller, let the engine idle for a minute to warm up. Before shutting it down, let the engine idle for two to three minutes to cool down.

**Never use starting fluids as they will cause permanent engine damage. Using them will void the warranty. Before you use the tiller, read the Safety & Warning rules on pages 5.**

## 2-Cycle Tiller Starting (Continued)

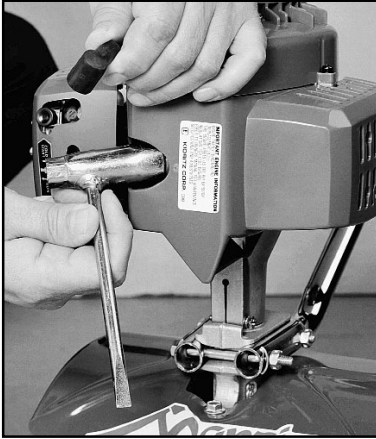

Picture 1



Picture 2

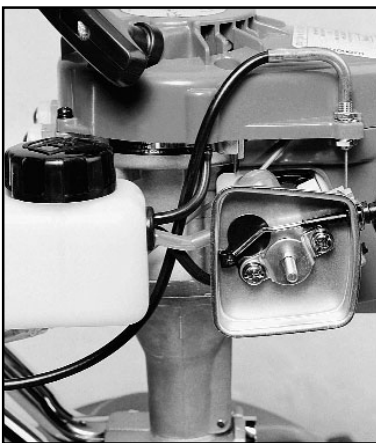

Picture 3

### WHAT TO DO JUST IN CASE

If you follow the normal starting procedure, you should have no problem starting your tiller. But, just in case you do have problems, here's what to do.

Make sure the **O/I** switch is on "I" (start). You'd be surprised how many people forget to push the switch into the "I" (start) position.

**If the switch was on "O" (stop) when you pulled the cord, you may have flooded the engine.**

- First, examine the spark plug. Use the special wrench that comes with our optional MANTIS Handy Item Kit (Item #8444) or a 3/4 inch spark plug wrench. (Picture 1)
- Remove the cap over the spark plug.
- Unscrew the spark plug. (Picture 2)

### **⚠ WARNING ⚠**

MAKE SURE THE START/STOP SWITCH IS IN THE STOP POSITION. KEEP PLUG WIRE AWAY FROM ENGINE TO AVOID UNINTENTIONAL SPARK.

### **IMPORTANT NOTE:**

**To avoid possible damage to the threads, do not try to remove the plug from a hot aluminum cylinder head.**

### STARTING A FLOODED ENGINE

If the end of the spark plug is wet, the engine may be flooded. **Make sure the switch is in the "O" (stop) position, disconnect spark plug wire and remove plug. Use a paper towel or a clean rag to dry the spark plug, then, with the spark plug out of the engine, pull the starter cord several times.** Next, replace the spark plug.

Use the wrench to tighten it and replace the cap. Then, put the switch in the "I" (start) position and pull the choke button out. Pull the starter cord three or four times until the engine coughs or sputters. Open the choke (push the choke button in) and pull the cord a few times. The engine should start and run.

### FUEL LINES CHECK

If the end of the spark plug is dry, check to see if the fuel line is blocked. First loosen the fuel cap to relieve the pressure in the tank. The fuel line runs from the fuel tank to the carburetor. Pull it off at the carburetor end. Fuel should drip slowly from the line. Wipe off any excess or spilled fuel.

If fuel does not drip from the line, check the line for any bends or pinches. (Picture 3). Kinks in the line restrict the flow of fuel to the engine. Just straighten out the line. Reconnect. Then follow the normal starting procedure.

If fuel drips too freely, the line may be disconnected from the fuel filter. You'll find the fuel filter inside the fuel tank. Just re-attach the line to the filter, and put the filter back in the tank. Then follow the normal starting procedure.

## 2-Cycle Tiller Operation

### **! WARNING**

If engine does not stop when switch is put in the stop position, release the throttle, allow engine to idle. Put the tiller down, and slide the choke lever to the cold start (closed) position. Have product serviced before using.

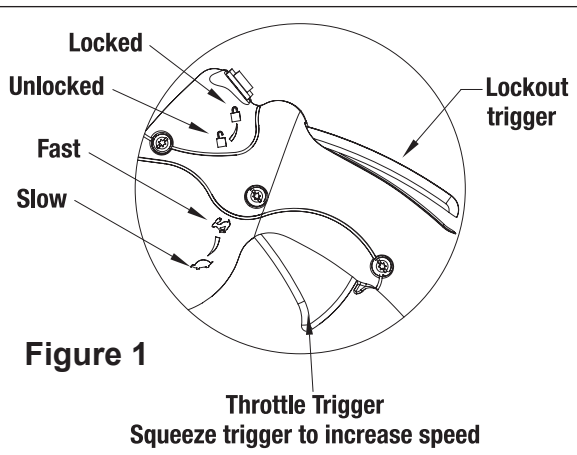

### A SPECIAL FEATURE

(With the idle set properly and the engine running)

Even when the engine is running, the tines won't turn unless you squeeze the throttle trigger on the handlebars. When you release the throttle trigger, the tines will stop.

### A TIP FOR EXTENDING YOUR ENGINE'S LIFE

After you start the engine, let your tiller warm up for two to three minutes before you use it. Then,

before you put your tiller away, let it idle for a minute to give the engine a chance to cool down.

### OPERATION

With engine running, and both hands on the handles, hold down the throttle lockout trigger (**Figure 1**), then squeeze the throttle trigger gradually to increase the engine speed and engage the tines.

**NOTE:** This step must be repeated each time your tiller trigger is released.

### **! WARNING**

Read the instructions carefully. Be familiar with the controls and the proper use of the equipment.

### NOW YOU'RE READY TO USE YOUR MANTIS TILLER.

If you've seen other tillers, your MANTIS Tiller may surprise you. It tills best when you pull it backward! You see, when you pull your MANTIS Tiller backward, you give extra resistance to the tines, so they dig deeper. (**Figure 2**)

In addition, when you go backward, you erase your footprints. So your soil stays light and fluffy. With other tillers, by contrast, you walk right over the soil you've just tilled, packing it down, so it's less plantable.

### RUN YOUR MANTIS TILLER LIKE A VACUUM CLEANER

Place your Tiller at the head of the row or area you want to till. Start it up. Then use an easy rocking motion. First, pull your Tiller backward. Then use an easy rocking motion. Again, pull your Tiller



backward. Then, let it move forward just a little bit. Then pull it backward again. This will help you till deeper.

Keep repeating these steps until you've tilled an entire row. Start again on the next row. It's much like running a vacuum cleaner! (**Figure 3**)

### You Can Even Control Depth.

#### For Deeper Tilling:

Move your Tiller slowly back and forth, as you would a vacuum cleaner. Work the same area over and over until you've dug to your desired depth. (**Figure 4**)

#### For Shallow Tilling:

Switch the tines to the cultivating position. (See page 14 to learn how.) Then move your Tiller quickly over your soil surface.

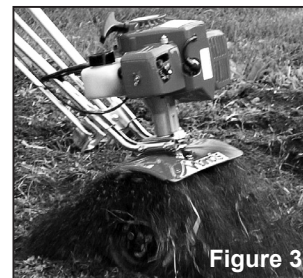

### For Big Weeds or Tough Roots:

Let your Tiller rock back and forth over the tough spot, until the tines slice through the weed or root.

### Your MANTIS Tiller Handles Special Tilling Projects:

Want to turn part of your lawn into a colorful flower border? Your MANTIS Tiller makes it easy! Just run your Tiller back and forth until the sod begins to break up. Then continue tilling. Your Tiller will chop the clumps of sod until they're fine. Then, it will work them into the soil. Pretty soon, you'll have a soft, fresh planting bed.

### **! WARNING !**

ALWAYS MAKE SURE THE HANDLE KNOBS ARE SECURE BEFORE STARTING YOUR MANTIS TILLER.

## 2-Cycle Tiller Operation (Continued)

### WARNING

If your tines get jammed or entangled, shut off the engine at once. Remove the obstruction while the engine is off. Never try to remove an obstruction while the engine is running. Serious injury can result.

### WARNING

The operator of this tiller is responsible for accidents or hazards occurring to himself, other people or their property.

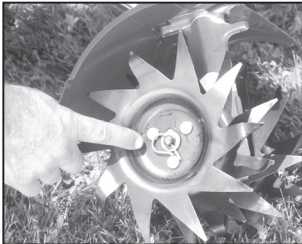

### YOUR MANTIS TILLER MAKES WEEDING A PLEASURE!

As a tiller, your MANTIS Tiller works the soil down to 10" (25.4 cm) deep. But, as a cultivator, it gently cultivates the surface, only 2" to 3" (5.09 cm to 7.62 cm) deep.

First, you must switch the tines to the weeding, cultivating position. This takes less than a minute.

Then, your MANTIS Tiller's sharp "tine teeth" will slice up those pesky weeds, burying them as you go along. And, since the tines in this position won't dig too deep, they won't hurt your plants' precious root systems.

The result? Your Tiller will cut your weeding time in half, and turn a tiresome chore into a pleasure.

### HOW TO SWITCH FROM TILLING TO CULTIVATING POSITION

1. Make sure your Tiller is off.
2. Remove the retaining pins from the tines.
3. Remove the tines from the axle.
4. Place the right-side tine onto the left-side axle. Place the left side tine onto the right-side axle. The "D" hole should be to the outside.
5. Reinsert the pins. **(Figure 1)**

#### Tilling

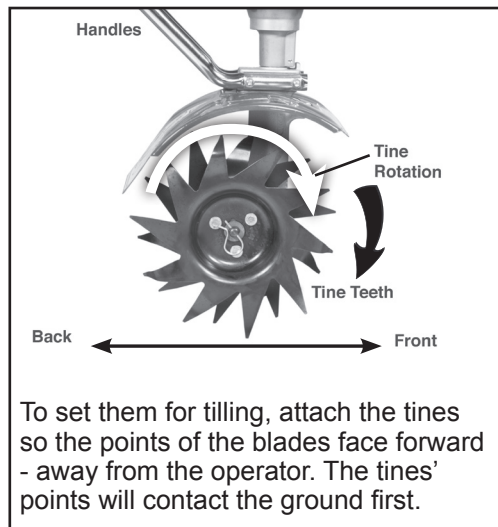

#### Cultivating

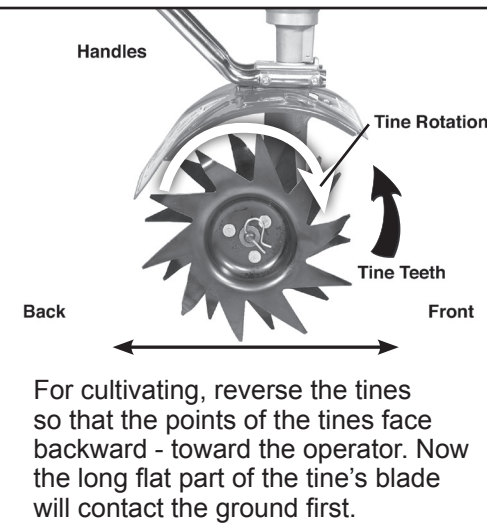

Figure 1

## 2-Cycle Tiller Transportation & Storage

### 2-CYCLE TILLER TRANSPORTATION

Transporting your Tiller is easy. It's light enough and easy to carry using the carrying handle as seen in **Figure 1**.

Or, with it running, you can walk it by gently squeezing the throttle until it moves at a comfortable pace.

Your tiller is easily transported in the back of a car or truck. Be sure to empty the fuel tank (This is crucial)! Then stow your tiller in the trunk of your car or truck.



Figure 1



Picture 1

**⚠ WARNING ⚠**  
 NEVER CARRY YOUR TILLER AS THE PERSON IN PICTURE 1 IS DOING. IF YOU DO, YOU WILL SUFFER SERIOUS INJURY.

### TILLER STORAGE

#### **⚠ WARNING**

**Never store the equipment with Fuel in the tank or in an area where fumes may accumulate and breach an open flame or spark**

Each fall, or before you store your Mantis Tiller for any long period, be sure to take these measures:

1. Do not store your Tiller with fuel still in it. Even under ideal conditions, stored fuel containing ethanol or MTBE can start to go stale in 30 days. And, since stale fuel has a high gum content, it can clog the carburetor, this, in turn, will restrict fuel flow. Therefore, **when you're ready to store your Tiller, or will not be using it for more than 2 weeks, drain the fuel tank completely.**
2. Next, restart the engine to make sure no fuel is left in the carburetor. Then, run the engine until it stops. This will prevent gum deposits, forming inside of the carburetor and possible engine damage.
3. Disconnect spark plug wire and remove the spark plug. Slowly pull the starter cord once.
4. Inspect the spark plug, and if necessary, clean it. If you need to replace it, buy a NGR-BPM8Y.
5. Install the spark plug, but leave the spark plug wire disconnected.
6. Wipe the tines with oil or spray them with WD-40, to prevent rusting.
7. Oil the throttle cable and all visible moving parts. (Do not remove the engine cover.)
8. Clean or replace the air filter.
9. Check or replace fuel filter.
10. Check the grease level in the worm gear housing. Add grease if needed.
11. Store your Tiller in an upright position in a clean, dry place. You can store with the handles in an extended position or folded down.  
 To fold the handles down, simply loosen the lower 2-pronged knobs until you can pivot the upper handles down. **(Figure 2)**  
 Or it can be hung using the handle brace.
12. Do you have fuel left over from last season? Dispose of it properly. Buy fresh oil and gasoline next season.
13. Remove Tilling Tines or attachments and lightly oil tine shaft at least once a year.

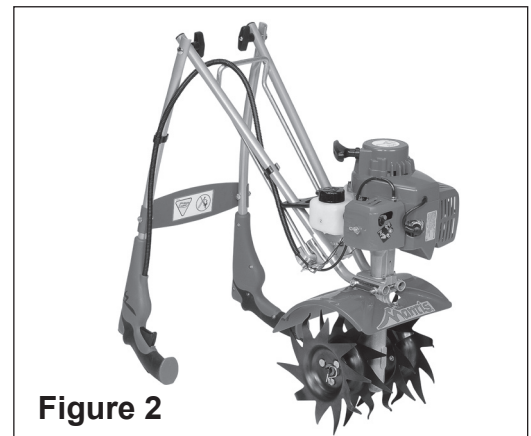

Figure 2

## 2-Cycle Tiller Maintenance

### HOW TO CHECK, CLEAN AND CHANGE THE AIR FILTER

1. Loosen the wing nut on the side of the air-cleaner cover. (Picture 1)
2. Take off the cover. Make sure to clear the choke button.
3. The air filter is the pad on the inside of the air-cleaner cover. Check whether it is soiled or moist.
4. If the air filter needs cleaning or no longer fits properly, remove it. Just lift an edge carefully and “peel” it out. (Picture 2)
5. Use a brush to remove debris from the pad.
6. If the air filter is so dirty that it won’t come clean, you must replace it or severe engine damage will occur. Order a new one directly from our Customer Service Dept. Call 1-800-366-6268.
7. Insert your clean filter inside the air-cleaner cover.

**IMPORTANT! Make sure filter is “seated” properly in the cover. The filter must fit snugly inside the rim that holds the filter in place.**

Installing the filter incorrectly will cause engine damage and void the warranty. Fit the cover back over the air cleaner. (Again, make sure to clear the choke button.)

8. Tighten the wing nut to secure the cover.

**Note:**

**Please check the lip on the Air Cleaner Cover. If the lip is chipped or cracked, it should be replaced. This will prevent dirt from being ingested through the carburetor into the inside of the engine.**



Picture 1

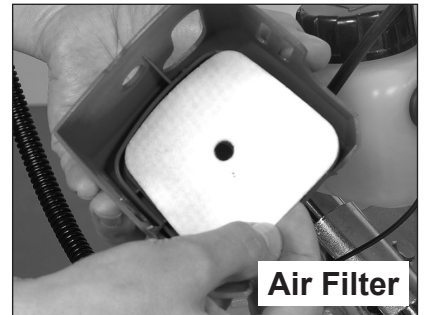

Picture 2

### FUEL FILTER REPLACEMENT

The fuel filter should be replaced every year. Open the fuel cap and using the cap retainer you can remove the fuel intake line. The filter is at the end.

Hold the fuel line and work the filter out. Then just push the new one back into the tube making sure the clamping wire is up high enough to engage with the stem of the filter.

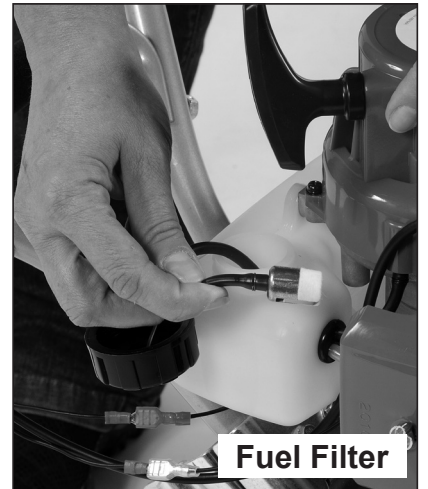



## 2-Cycle Tiller Maintenance

### **⚠ WARNING • DANGER ⚠**

REMOVE TINES BEFORE STARTING ENGINE AND MAKING ADJUSTMENTS

#### WHAT TO DO IF YOUR ENGINE IDLES TOO HIGH

What if your engine runs too fast ... or if the tines turn the instant you start the Tiller? You may need to adjust the idle screw right below the H and L screws. Gently turn it counter-clockwise. You'll know you've adjusted it correctly when the axles do not turn at low idle.

#### WHAT TO DO IF YOUR ENGINE RUNS "ROUGH" CARBURATOR ADJUSTMENT

If your engine runs "rough" or stalls, you may need to adjust the carburetor and idle screws.

If you remove the air-cleaner cover, you'll see the two carburetor, adjustment screws

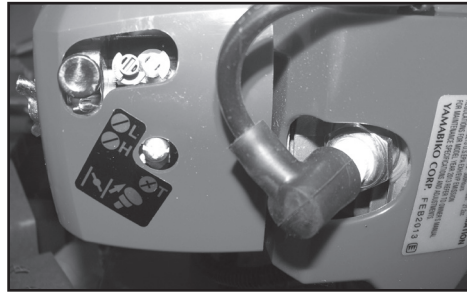

Picture 1

next to the choke button. (Picture 1)

The "RED" screw is the HIGH-speed adjustment...The "WHITE" screw is the low speed adjustment.

First, remove the tines from the axle. Then start engine. Let it run for two to three minutes. "FLASH" the choke several times during the warm-up by closing and opening it while engine runs in order to clear any air from the Fuel system.

Then stop the engine after it reaches operating temperature.

Now, turn the RED, high-speed screw counter-clockwise all the way to stop... Then turn the WHITE, low speed screw halfway between the counter-clockwise and clockwise stop positions.

Now restart the engine to finish the carburetor adjustment.

Run the engine at full speed two or three seconds to clear out any excess fuel. Then return to idle.

Now, accelerate the engine to full throttle several times to check for a smooth transition from idle to high speed.

If the engine hesitates turn the WHITE, low-speed screw counter-clockwise one-eighth of a turn. Then accelerate the engine.

Repeat the adjustment until you get a smooth transition to high speed.

#### HIGH ALTITUDE OPERATION

This engine has been factory adjusted to maintain satisfactory starting, emission, and durability performance up to 1,100 feet (96,0 kPa and above) mean sea level (MSL). To maintain proper engine operation above 1,100 feet (96,0 kPa and above) MSL the carburetor may need to be adjusted by an authorized ECHO service dealer.

#### IMPORTANT

If the engine is adjusted for operation above 1,100 feet MSL, the carburetor must be re-adjusted when operating the engine below 1,100 feet MSL, otherwise severe engine damage can result.

#### EXHAUST PORT/MUFFLER CLEANING

Tools required: 4mm Hex wrench, Wood or plastic scraper

Parts Required: As needed: Heat Shield

1. Remove spark plug lead from spark plug, and remove engine cover (2 screws).
2. Place piston at top dead center. Remove muffler (A) and heat shield (B).
3. Use a wood or plastic scraping tool to clean deposits from cylinder exhaust port.

#### IMPORTANT

Never use a metal tool to scrape carbon from the exhaust port. Do not scratch the cylinder or piston when cleaning the exhaust port. Do not allow carbon particles to enter the cylinder.

4. Inspect heat shield, and replace if damaged.
5. Install heat shield and muffler.

6. Tighten muffler mounting bolts (or nuts) to 80-95 in•lbf (90-110 kgf•cm).
7. Start engine, and warm to operating temperature.
8. Stop engine, and re-tighten mounting bolts (or nuts) to specifications.
9. Install engine cover and attach spark plug lead.

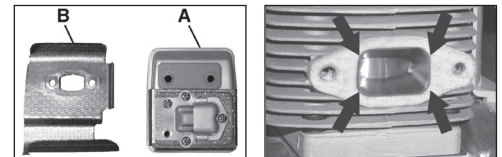

#### CLEANING THE MUFFLER SCREEN

1. Take out the spark plug.
2. Remove the red cylinder cover, (#D1) which is held on by 2 phillips-head screws, (#D2) and 1 hex-head screw, (#D3) which you will need an allen wrench to remove.
3. You will see the metal exhaust guide, held on by 3 more phillips-head screws. (#C1) Remove the exhaust guide.

4. Behind the exhaust guide (#C2) will be the muffler gasket (#C3) and muffler screen (#C4). The screen sits under the gasket.

5. If the screen (#C4) is clogged with deposits, it needs to be cleaned. Use carburetor cleaner, and any brush that is not metal. Brush the screen until you are able to see through it.

6. If the screen remains plugged after attempts at cleaning, it must be replaced.

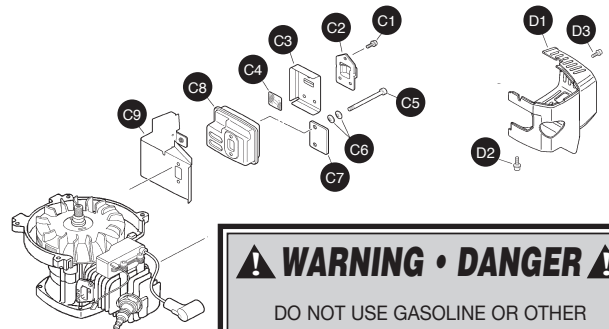

### **⚠ WARNING • DANGER ⚠**

DO NOT USE GASOLINE OR OTHER FLAMMABLE SUBSTANCE

## 2-Cycle Tiller Maintenance

### HOW TO RESEAT THE FLANGE

At some point, you may find that the tines won't turn when you press the throttle. This may mean the engine isn't sitting all the way down on the worm gear housing.

Perhaps you've been using your Tiller for several years. Or perhaps you've removed the engine for use with our hedge trimmer attachment, then replaced it. In either case, the flange bolt may have come loose and lifted the engine up.

If this happened you'll notice a gap between the bottom of the engine clutch case and the top of the worm gear housing. **(Figure 1)**

To fix this, loosen the flange bolt. Take the engine off the worm gear housing. Notice the hex head on top of the drive shaft. Inside the clutch case, you'll find the clutch drum. Make sure the hex head lines up with the clutch drum inside the clutch case.

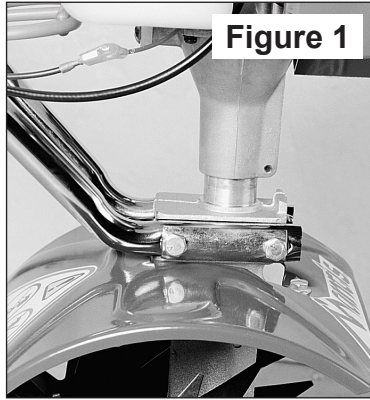

Note how the engine doesn't sit all the way down on the transmission.

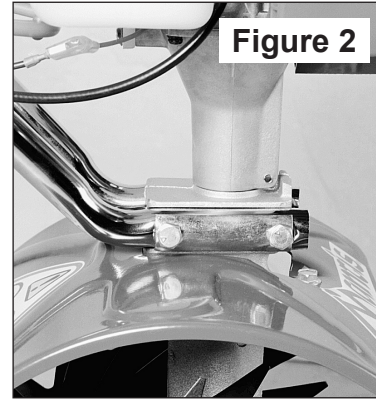

Note how the engine sits all the way down on the transmission.

Then put the engine back on the worm gear housing. Make sure the plastic carrying handle is not under the fuel tank.

If you've followed these steps properly, there will be no gap between the clutch

case and the worm gear housing. **(Figure 2)** Make sure you tighten the flange bolt!

### TRANSMISSION CARE

Check the transmission grease level after the first 10 hours of use, then check yearly.

With the tines off, remove the transmission plate **(Figure 3)** and gasket to see if the grease level is up to the plate flange **(Figure 4)**. If it is not, you will need to add lithium zero or lithium one grease.

Wipe off any excess grease, replace the transmission gasket and plate.

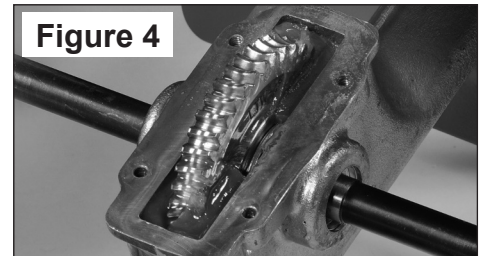

## Troubleshooting

Problem	Cause	Remedy
1. Tines don't turn when throttle is depressed	<ul style="list-style-type: none"> <li>Engine is not seated properly on the gear housing.</li> </ul>	<ul style="list-style-type: none"> <li>Re-install engine following the instructions on page 18 "How to reseat the flange".</li> </ul>
2. Engine fails to start	<ul style="list-style-type: none"> <li><b>O/I</b> switch is in "<b>O</b>" position.</li> <li>No fuel in tank.</li> <li>Fuel strainer clogged.</li> <li>Fuel line clogged.</li> <li>Spark plug shorted or fouled.</li> <li>Spark plug is broken (cracked porcelain or electrodes broken)</li> <li>Ignition lead wire shorted, broken or disconnected from spark plug.</li> <li>Ignition inoperative</li> </ul>	<ul style="list-style-type: none"> <li>Move switch to "<b>I</b>"</li> <li>Fill Tank.</li> <li>Replace Strainer.</li> <li>Clean fuel line.</li> <li>Install new spark plug.</li> <li>Replace spark plug.</li> <li>Replace lead wire or attach to spark plug.</li> <li>Contact your local authorized dealer.</li> </ul>
3. Engine hard to start.	<ul style="list-style-type: none"> <li>Water in gasoline or stale fuel mixture.</li> <li>Too much oil in fuel mixture.</li> <li>Engine under or over choked.</li> <li>Carburetor out of adjustment.</li> <li>Gasket leaks (carburetor or cylinder base gasket).</li> <li>Weak spark at spark plug.</li> </ul>	<ul style="list-style-type: none"> <li>Drain entire system and refill with fresh fuel.</li> <li>Drain and refill with correct mixture.</li> <li>If flooded by over choking, proceed according to instructions in operation section. If under choked, move choke lever to closed position and crank two or three times.</li> <li>See "Carburetor Adjustment."</li> <li>Replace gaskets.</li> <li>Contact your local authorized dealer.</li> </ul>
4. Engine continuously floods.	<ul style="list-style-type: none"> <li>Fuel tank vent line is not in an upright position.</li> </ul>	<ul style="list-style-type: none"> <li>Return the fuel tank vent line to the upright position and place it under the cylinder cover in the small "pocket" in the cylinder cover</li> </ul>
5. There is black smoke coming from exhaust	<ul style="list-style-type: none"> <li>The muffler screen is clogged</li> </ul>	<ul style="list-style-type: none"> <li>Clean carbon from muffler screen (page 17)</li> </ul>
6. Engine misses.	<ul style="list-style-type: none"> <li>Dirt in fuel line or carburetor.</li> <li>Carburetor improperly adjusted.</li> <li>Spark plug fouled, broken or incorrect gap setting.</li> <li>Weak or intermittent spark at spark plug.</li> </ul>	<ul style="list-style-type: none"> <li>Remove and clean.</li> <li>See "Carburetor Adjustment" (page 17)</li> <li>Clean or replace spark plug - set gap to .024-.028 in. (0.6-0.7 mm)</li> <li>Contact your local authorized dealer.</li> </ul>
7. Engine lacks power.	<ul style="list-style-type: none"> <li>Air filter clogged.</li> <li>Carburetor out of adjustment.</li> <li>Muffler clogged.</li> <li>Clogged exhaust ports.</li> <li>Spark Arrestor Clogged.</li> <li>Poor compression.</li> </ul>	<ul style="list-style-type: none"> <li>Clean or replace air filter.</li> <li>See "Carburetor Adjustment".</li> <li>Clean carbon from muffler.</li> <li>Remove muffler, rotate engine until the piston is at top of cylinder. With a wooden scraper or blunt tool, remove all carbon from exhaust ports. Be careful not to scratch or damage piston or cylinder walls. Blow out all loose carbon with compressed air. Install muffler and gasket.</li> <li>Clean muffler screen (page 17)</li> <li>Contact your local authorized dealer.</li> </ul>
8. Engine overheats.	<ul style="list-style-type: none"> <li>Insufficient oil in fuel mixture</li> <li>Air flow obstructed</li> </ul>	<ul style="list-style-type: none"> <li>Mix fuel as described in starting instructions.</li> <li>Clean flywheel cylinder fins and screen.</li> </ul>
9. Engine noisy or knocking.	<ul style="list-style-type: none"> <li>Spark plug in incorrect heat range.</li> <li>Bearings, piston ring or cylinder walls are worn.</li> </ul>	<ul style="list-style-type: none"> <li>Replace with plugs specified for engine.</li> <li>Contact your local authorized dealer.</li> </ul>
10. Engine stalls under load.	<ul style="list-style-type: none"> <li>Carburetor adjustment too "lean."</li> <li>Engine overheats.</li> </ul>	<ul style="list-style-type: none"> <li>See "Carburetor Adjustment." (page 17)</li> <li>Remove dust and dirt from between fins.</li> </ul>

## 2-Cycle Tiller Assembly

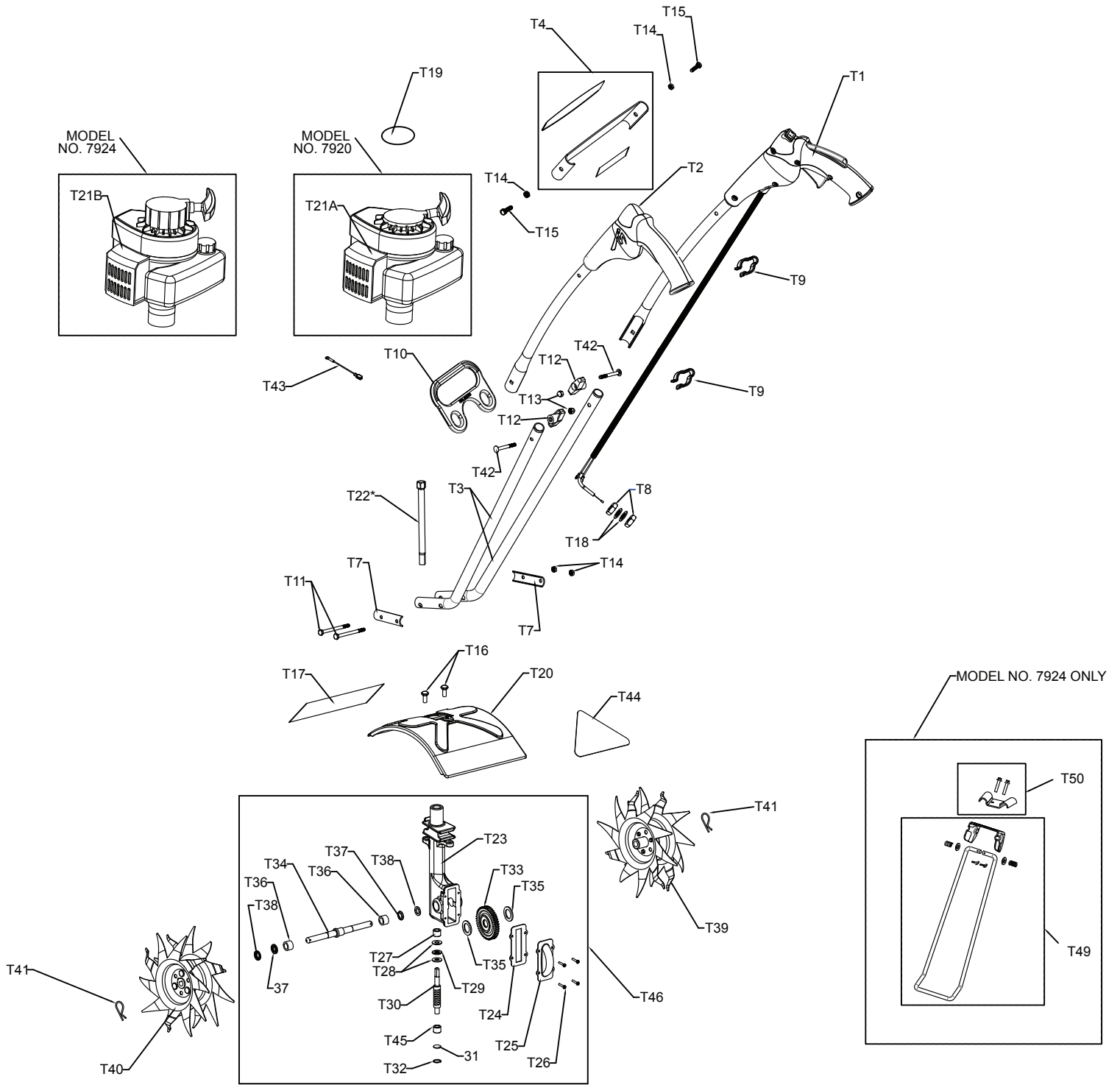

# Parts List

Key	Qty.	Part No.	Description
T26	4	651	#8 Self Tapping Screw
T27	1	423	Roller Bearing
T28	2	425	Worm Bearing Race
T29	1	424	Worm Thrust Bearing
T30	1	422	Worm Shaft
T31	1	426	Worm Disk
T32	1	428	Retaining Ring
T33	1	429	Worm Gear
T34	1	431	Tine Shaft
T35	2	430	Worm Gear Thrust Washer
T36	2	432	Worm Gear Bearing
T37	2	434	Bearing Seal
T38	2	435	Bearing Seal Retainer
T39	1	438RA	Tine Assembly, Right
T40	1	438LA	Tine Assembly, Left
T41	2	418-1	Tine Retaining Pin
T42	2	430039	Carriage Bolt 1/4-20 X 2.25"
T43	1	430042	Ground Wire Jumper, 2 Cycle Engine
T44	1	400630	Triangle Warning Label (2 Cycle Engine)
T45	1	458	Roller Bearing
T46	1	400010	Worm Gear Transmission Assembly
T49	1	410158	Kickstand, Stand Assembly (Model No. 7924)
T50	1	410113	Kickstand, Bracket And Hardware (Model No. 7924)

Key	Qty.	Part No.	Description
T1	1	430069	Upper Handle Throttle Side Assembly
T2	1	430071	Upper Handle Assembly, Left
T3	2	430082	Lower Handle W/Plug
T4	1	430084	Handle Brace Assembly
T7	2	377	Handle Clamp
T8	2	4078	M6 Jam Nut
T9	2	478	Throttle Clip
T10	1	400133	Carry Handle
T11	2	470	Bolt 1/4-20 X 3"
T12	2	400523	Knob, Two Prongs, Female
T13	2	395	Acorn Nut
T14	4	972	1/4-20 Two-Way Lock Nut
T15	2	144-2	1/4-20 X 1.125 Hex Head Cap Screw
T16	2	140	Bolt 1/4-20 X 3/8" Long
T17	1	430058	Mantis Logo Label
T18	2	4079	M6 Internal Lock Washer
T19	1	487MA	Engine Label
T20	1	465	Fender Guard
T21A	1	400908	Engine Assembly SV-5C/2 (Model No. 7920)
T21B	1	400904	Engine Assembly SV-5C/2 (Model No. 7924)
T22*	1	468	Drive Shaft
T23	1	466	Worm Gear Housing
T24	1	436	Gasket
T25	1	437A	Gear Housing Cover

\*Also in key T46



## Parts Assemblies

**Model 7920 | Model 7924**  
**SV-5C12 Engine | SV-5C12 Engine**

### Carburetor - C1U-K82 Explosion A

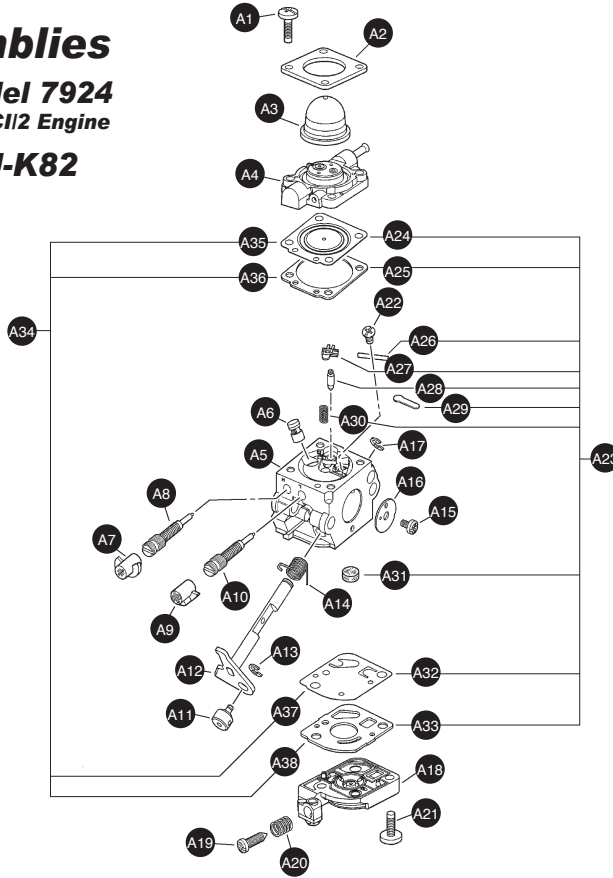

Key	Part No.	Qty.	Description
	A021001090	1	Carburetor - C1U-K82
A1	P005000980	4	Screw, Purge Bulb Retainer
A2	P005000620	1	Retainer, Purge Bulb
A3	12538108660	1	Bulb, Purge
A4	P005000970	1	Base, Purge
A5	-----	1	Body, Carburetor / Not Available Separately
A6	12537613120	1	Nozzle, Check Valve
A7	12532939030	1	Cap, Limiter
A8	12532013310	1	Needle - High Speed
A9	12532909860	1	Cap, Limiter
A10	12531813120	1	Needle - Low Speed
A11	12537242030	1	Swivel
A12	P005001070	1	Shaft, Throttle
A13	12532713930	1	Ring, Retaining
A14	12531342030	1	Spring, Return
A15	12531413930	1	Screw, Valve
A16	12531649030	1	Valve, Throttle
A17	12532715130	1	Ring, Retaining
A18	12532412820	1	Base, Purge
A19	12533406960	1	Screw, Idle Adjust
A20	12533306960	1	Spring, Idle Adjust
A21	12531012820	2	Screw, Pump Cover
A22	12533942030	1	Screw, Metering Lever Pin
A23	12530013120	1	Repair Kit / Includes Items 24-33
A24	-----	1	Diaphragm, Metering
A25	-----	1	Gasket, Metering Diaphragm
A26	-----	1	Pin, Metering Lever
A27	-----	1	Lever, Metering
A28	-----	1	Valve, Inlet Needle
A29	-----	1	Plug, Welch
A30	-----	1	Spring, Metering Lever
A31	-----	1	Strainer
A32	-----	1	Diaphragm, Pump
A33	-----	1	Gasket, Pump
A34	12530313120	1	Diaphragm/Gasket Kit / Includes Items 35-38
A35	-----	1	Diaphragm, Metering
A36	-----	1	Gasket, Metering
A37	-----	1	Diaphragm, Pump
A38	-----	1	Gasket, Pump

### Air Cleaner Explosion B

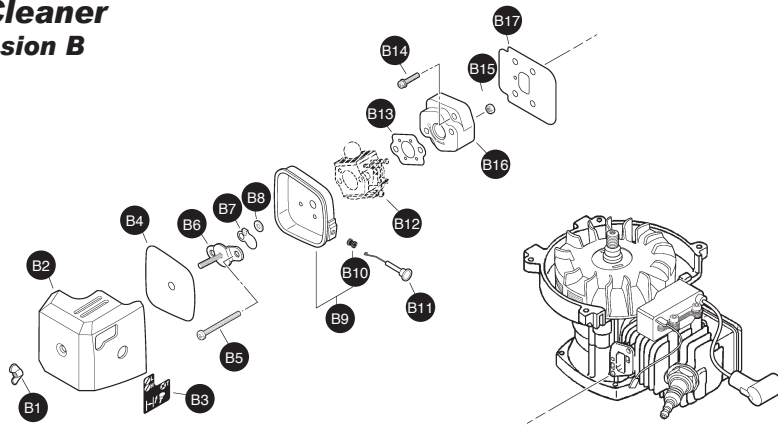

Key	Part No.	Qty.	Description
B1	90052800005	1	Wingnut - 6
B2	13032611522	1	Cover, Air Filter
B3	89012147530	1	Label - Choke
B4	13031004560	1	Filter, Air
B5	90024205057	2	Screw - 5X57
B6	13041005360	1	Plate, Prevent
B7	17851504560	1	Shutter, Choke
B8	17851600830	1	Washer - 5
B9	13030104560	1	Case, Air Filter Includes Item 10
B10	17881005230	1	Grommet
B11	17851004560	1	Rod, Choke
B12	-----	1	Carburetor <sup>1</sup>
B13	13001642031	1	Gasket, Intake
B14	90023805020	2	Screw - 5X20
B15	90050000005	2	Nut - 5
B16	13001742031	1	Insulator, Intake
B17	V103000490	1	Shield, Intake

<sup>1</sup>See Carburetor Diagram For Details

### Muffler Explosion C

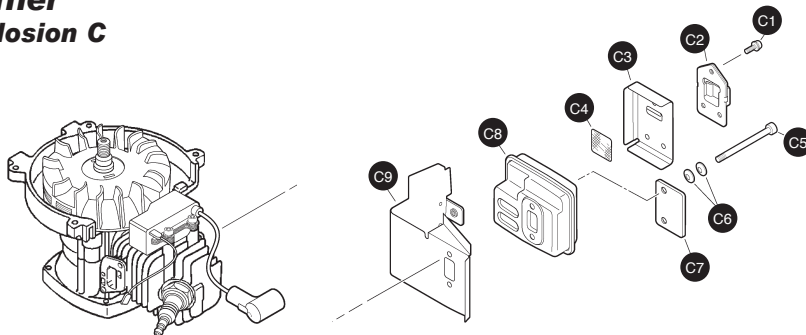

Key	Part No.	Qty.	Description
C1	9136704012	3	Screw - 4X12
C2	A313000700	1	Guide, Exhaust
C3	V104000072	1	Gasket, Exhaust/Included In Gasket Kit
C4	14586240630	1	Screen, Spark Arrestor
C5	90010505055	2	Screw - 5X55
C6	V347000000	1	Washer - Conical
C7	V150000371	1	Plate
C8	A300000521	1	Muffler
C9	V104000590	1	Shield Exhaust/Included In Gasket Kit

## Parts Assemblies

**Model 7920 | Model 7924**  
**SV-5C/2 Engine | SV-5CII/2 Engine**

**Engine Cover, Fancase,  
 Clutch Case & Clutch  
 Explosion D**

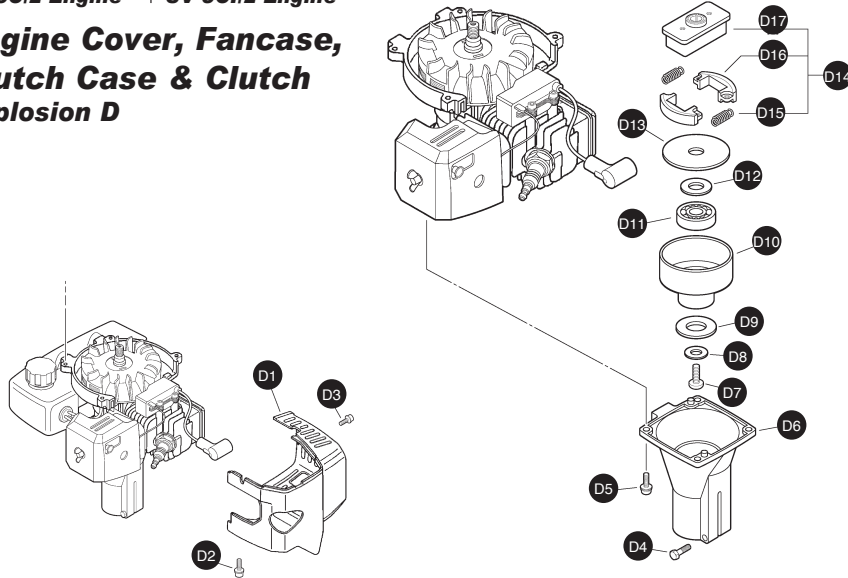

Key	Part No.	Qty.	Description
D1	A160000610	1	Cover, Engine
D2	90023804018	2	Screw - 4X18
D3	9110704008	1	Screw - 4X8
D4	13041611520	1	Bolt - 5X25
D5	90023804018	4	Screw - 4X18
D6	61022311520	1	Case, Clutch
D7	90023806012	1	Screw - 6X12
D8	17501411520	1	Washer, Clutch
D9	17504404630	1	Washer, Clutch
D10	17501004635	1	Drum, Clutch
D11	90080836000	1	Bearing, Ball - 6000
D12	90060000010	1	Washer - 10
D13	17501904630	1	Plate, Clutch
D14	17500007531	1	Clutch Asy
D15	17501805130	2	Spring, Clutch
D16	17500905131	2	Shoe, Clutch
D17	17501605020	1	Hub, Clutch

## Ignition, Engine & Short Block Explosion E

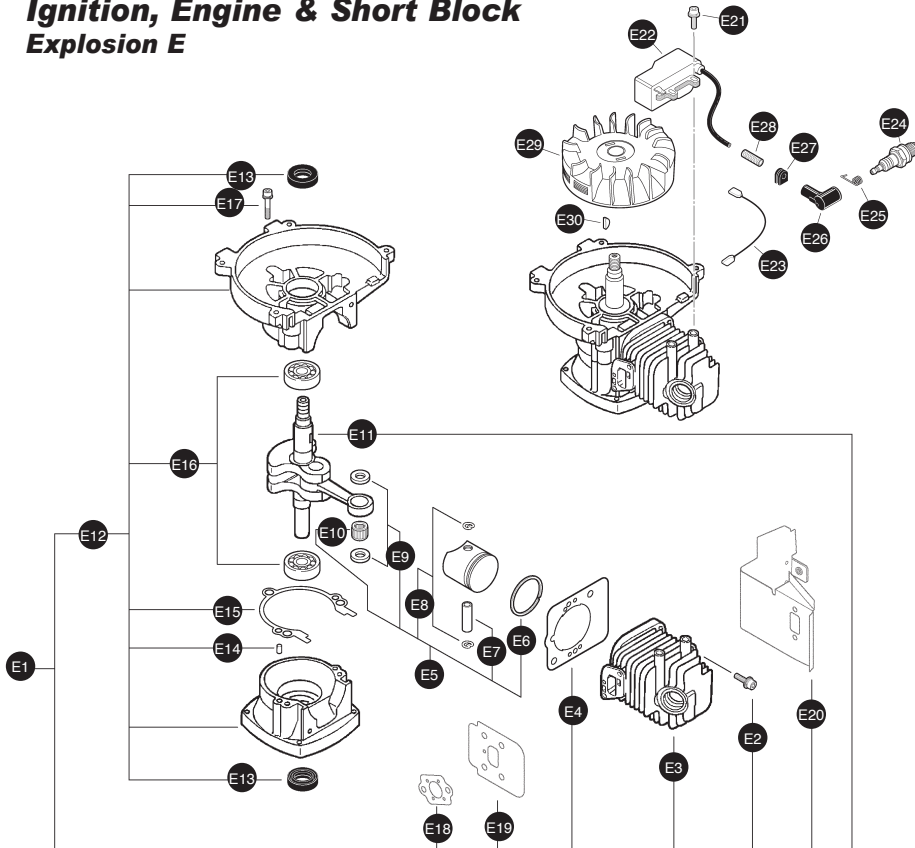

Key	Part No.	Qty.	Description
E1	SB1087	1	Short Block -- Sb1087 Includes Items 2-17
E2	90016205022	2	Screw - 5X22
E3	A130000550	1	Cylinder
E4	V100000160	1	Gasket, Cylinder Included In Gasket Kit
E5	P021007712	1	Piston Kit Includes Items 6-9
E6	A101000090	1	Ring, Piston
E7	10001311520	1	Pin, Piston
E8	10001504630	2	Ring, Retaining
E9	10001411520	2	Spacer, Piston
E10	A011000390	1	Crankshaft Asy Includes Item 11
E11	V553000060	1	Bearing, Needle - 8
E12	10020411521	1	Crankcase Kit Items 13-17
E13	10021242031	2	Seal, Oil
E14	V622000020	2	Pin, Locating
E15	10024242030	1	Gasket, Crankcase Included In Gasket Kit
E16	9403536201	2	Bearing, Ball - 6201
E17	90016205028	3	Screw - 5X28
E18	-----	1	Gasket, Intake Included In Gasket Kit
E19	-----	1	Shield, Intake Included In Gasket Kit
E20	-----	1	Shield, Exhaust Included In Gasket Kit
E21	9111304020	2	Screw - 4X20
E22	A411000220	1	Coil, Ignition
E23	16202152830	1	Lead - Ignition
E24	15901019830	1	Spark Plug -- BPM-8Y
E24	A425000000	1	Spark Plug -- BPMR-8Y Canada Models
E25	15901103432	1	Terminal, Spark Plug Cap
E26	15901201620	1	Cap, Spark Plug
E27	15611004920	1	Grommet
E28	V475002200	1	Tube, Insulator
E29	A409000150	1	Flywheel
E30	61032502730	1	Key, Woodruff

# Parts Assemblies

**Model 7920** | **Model 7924**  
 SV-5C12 Engine | SV-5C12 Engine

## Engine Starter Explosion F

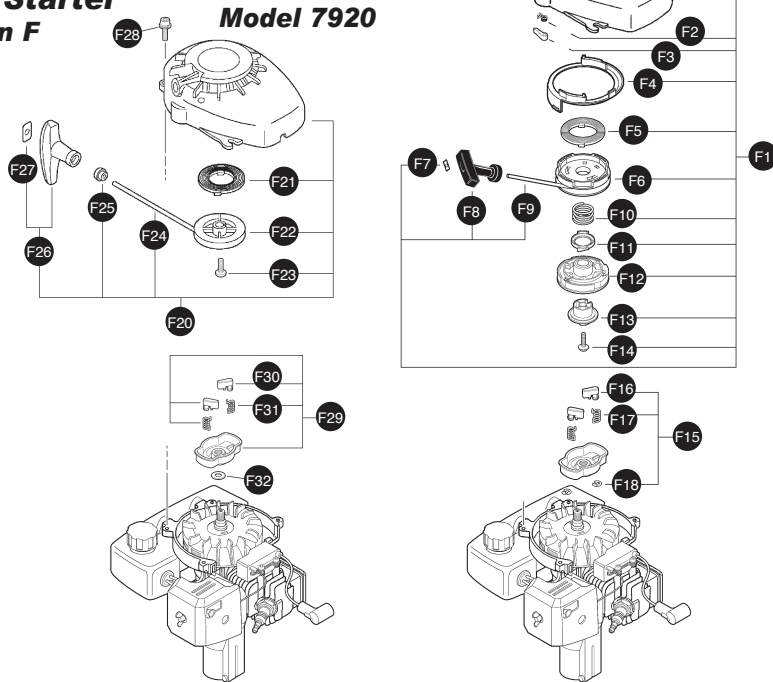

## Model 7924

Key	Part No.	Qty.	Description
F1	A051000640	1	Starter Assy Includes Items 2-8
F2	P022004610	2	Spring, Pawl Return
F3	P022004620	2	Pawl, Starter
F4	P022006500	1	Case, Starter
F5	P022004680	1	Spring, Rewind
F6	P022004690	1	Reel, Rope
F7	17724611120	1	Retainer, Rope
F8	P022004990	1	Grip, Starter
F9	P022004600	1	Rope, Starter - 3 X 800'
F10	P022004660	1	Spring, Return
F11	P022004670	1	Pawl
F12	P022004700	1	Spring Assy
F13	P022004640	1	Plate, Cam
F14	P022004630	1	Screw
F15	A052000150	1	Starter Pawl Assy Includes Items 16-18
F16	P022004740	2	Pawl, Starter
F17	17723412220	2	Spring, Return
F18	P022002100	2	Ring, Retaining - 4
F19	90016304016	4	Screw - 4 X 16

## Model 7920

Key	Part No.	Qty.	Description
F20	A051000950	4	Starter Assy Includes Items 2-8
F21	17722042030	1	Spring, Rewind
F22	17721544430	1	Reel, Rope
F23	17723644330	1	Screw
F24	17722605530	1	Rope, Starter - 3 X 890'
F25	17722742030	1	Guide, Rope
F26	17722811120	1	Starter Grip Assy Includes Item 8
F27	17724611120	1	Retainer, Rope
F28	90023804016	4	Screw - 4 X 16
F29	17720212220	1	Starter Pawl Assy Includes Items 11-12
F30	17721844330	2	Pawl, Starter
F31	17723412220	2	Spring, Return
F32	90060500008	1	Lockwasher - 8

<sup>1</sup>RePower BULK OPTION: 99944440000

## Fuel System Model 7920 Explosion G

### Gasket Kit

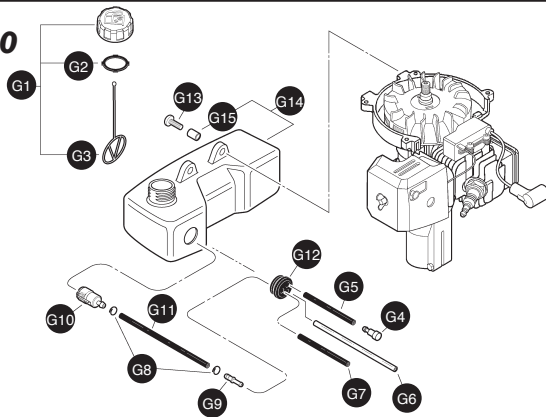

Key	Part No.	Qty.	Description
G1	P021034480	1	Cap Assy - Black Includes Item 2-3
G2	V107000150	1	Gasket, Cap
G3	13105156030	1	Connector, Cap
G4	A356000031	1	Vent, Fuel Tank
G5	V471001200	1	Pipe - 3 X 5 X 70 -- Black <sup>1</sup>
G6	13201006460	1	Pipe - 3 X 6 X 110 -- Clear <sup>2</sup>
G7	V471003720	1	Pipe - 3 X 5 X 70 -- Black <sup>3</sup>
G8	V490001240	2	Clip - 6
G9	V186000520	1	Connector, Fuel Pipe
G10	13120507320	1	Filter, Fuel
G11	V471003730	1	Pipe - 3X5x140 -- Black <sup>1</sup>
G12	13211546730	1	Grommet
G13	90027505015	2	Screw - 5X16 -- Tapping
G14	A350000300	1	Fuel tank Assy Includes Item 15
G15	13104528230	21	Sleeve
G16	P021009110	1	Gasket Kit

<sup>1</sup>RePower Bulk Option: 90014

<sup>2</sup>RePower Bulk Option: 90017

<sup>3</sup>RePower Bulk Option: N/A

## Fuel System Model 7924 Explosion H

### Gasket Kit

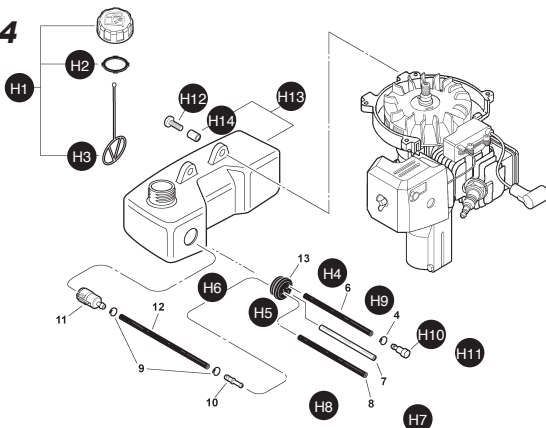

Key	Part No.	Qty.	Description
H1	P021034480	1	Cap Assy - Black Includes Items 2-3
H2	V107000150	1	Gasket, Cap
H3	13105156030	1	Connector, Cap
H4	13011100530	2	Clip - 5.5
H5	13130056431	1	Vent, Fuel Tank
H6	V471001200	1	Pipe - 3 X 5 X 70 -- Black <sup>1</sup>
H7	13201049030	1	Pipe - 3 X 6 X 50 -- Clear <sup>2</sup>
H8	V471003720	1	Pipe - 3 X 5 X 70 -- Black <sup>3</sup>
H9	V490001240	2	Clip - 6
H10	V186000520	1	Connector, Fuel Pipe
H11	13120507320	1	Filter, Fuel
H12	V471003730	1	Pipe - 3 X 5 X 140 -- Black <sup>1</sup>
H13	13211546730	1	Grommet
H14	90027505015	2	Screw - 5 X 16 -- Tapping
H15	A350001630	1	Fuel Tank Assy Includes Item 16
H16	13104528230	2	Sleeve
H17	P021009110	1	Gasket Kit

<sup>1</sup>RePower Bulk Option: 90014

<sup>2</sup>RePower Bulk Option: 90017

<sup>3</sup>RePower Bulk Option: N/A





## **ECHO INCORPORATED EMISSION CONTROL WARRANTY STATEMENT** **FOR ECHO AND SHINDAIWA BRANDS**

The Environmental Protection Agency (EPA) and the California Air Resources Board (C.A.R.B.) and ECHO Incorporated (ECHO Inc.) are pleased to explain the emission control system warranty on your 2010 and later equipment/small off-road engine (SORE). New equipment/SORE must be designed, built and equipped to meet stringent EPA and C.A.R.B. anti-smog standards. ECHO Inc. must warrant the emission control system on your equipment/SORE for the periods of time listed below, provided there has been no abuse, neglect or improper maintenance of your equipment/SORE. Your emission control system may include parts such as: carburetor, fuel-injection system, ignition system, catalytic converter/muffler, fuel tank, fuel feed lines, fuel cap assembly, spark plug, air filters, and other associated components. Where a warrantable condition exists, ECHO Inc will repair your equipment/SORE at no cost to you including diagnosis, parts and labor. The Emission Control System warranty is extended to the original owner including all subsequent owners.

### **MANUFACTURER'S WARRANTY COVERAGE:**

The emission control system is warranted for 2 years or the length of the ECHO Inc. warranty, whichever is longer. If any emission-related part on your equipment is defective, the part will be repaired or replaced by ECHO Inc. or its Authorized Service Representative.

### **OWNER'S WARRANTY RESPONSIBILITIES:**

As the equipment/SORE owner, you are responsible for the performance of the required maintenance listed in your Operator's Manual. ECHO Inc. recommends that you retain all receipts covering maintenance on your equipment/SORE however, ECHO Inc. cannot deny warranty solely for the lack of receipts or for your failure to ensure the performance of all scheduled maintenance. As the equipment/SORE owner, you should be aware that ECHO Inc. may deny you warranty coverage if your equipment/SORE or a part has failed due to abuse, neglect, improper maintenance or unapproved modifications.

You are responsible for presenting your equipment/SORE to an ECHO Inc. authorized service representative as soon as a problem exists. The warranty repairs should be completed in a reasonable amount of time, not to exceed 30 days. If a warrantable condition exists and there is no Authorized Dealer within 100 miles, ECHO Inc. will pay to ship the unit to the nearest authorized dealer. If you have questions regarding your warranty coverage, you should contact ECHO Inc. at 1-800-673-1558, web site WWW.ECHO-USA.COM or contact Shindaiwa at 1-877-986-7783, web site WWW.SHINDAIWA.COM.

### **WHAT DOES THIS WARRANTY COVER?**

ECHO Inc. warrants that your equipment/SORE was designed, built and equipped to conform with applicable EPA and C.A.R.B. emissions standards and that your equipment/SORE is free from defects in material and workmanship that would cause it to fail to conform with applicable requirements for 2 years or the length of the ECHO Inc. warranty, whichever is longer. The warranty period begins on the date the product is purchased by an end user..

### **HOW WILL A COVERED PART BE CORRECTED?**

If there is a defect in a part covered by this warranty, any ECHO Inc. Authorized Service Dealer will correct the defect. You will not have to pay anything to have the part adjusted, repaired or replaced. This includes any labor and diagnosis for warranted repairs performed by the dealer. In addition, engine parts not expressly covered under this warranty but whose failure is a result of a failure of a covered part will be warranted.

### **WHAT PARTS ARE COVERED?**

- Any applicable emission related part not scheduled for "required maintenance" will be repaired or replaced within the warranty period. The repaired or replaced part will be warranted for the remaining ECHO Inc. warranty period.
- Any warranted part that is scheduled only for regular inspection in the written instructions supplied is warranted for the warranty period stated above. Any such part repaired or replaced under warranty will be warranted for the remaining ECHO Inc. warranty period.
- Any emission related part scheduled for replacement during "required maintenance" is warranted for the period of time prior to the first scheduled replacement point for that part. Any such part repaired or replaced under warranty shall be warranted for the remainder of the period prior to the first scheduled replacement point for that part.
- Any manufacturer-approved replacement part may be used in the performance of any warranty maintenance or repairs on emission related parts, and must be provided without charge if the part is still under warranty.
- Any replacement part that is equivalent in performance and durability may be used in non-warranty maintenance or repairs, and shall not reduce the warranty obligations of the manufacturer.
- Throughout the equipment/SORE warranty period, ECHO Inc. will maintain a supply of warranted parts sufficient to meet the expected demand for such parts.

### **SPECIFIC EMISSION RELATED WARRANTED PARTS:**

- Electronic Ignition System
- Spark Plug
- Catalytic Converter / Muffler Assembly
- Carburetor (complete assembly or replaceable components)
- Choke
- Fuel-Injection Assembly (or replaceable components)
- Fuel Tank
- Fuel Cap Assembly
- Air Filter
- Fuel Feed Line (and associated clamps/connectors as applicable)

### **WHAT IS NOT COVERED?**

Any failure caused by abuse, neglect, improper maintenance, unapproved modifications, use of unapproved add-on parts/modified parts or unapproved accessories.

This Emission Control Warranty is valid only for the U.S.A., it's Territories, and Canada. 99922201033 01/2010

**Contact us at [www.mantis.com](http://www.mantis.com)**



## **EPA PHASE 2 / CALIFORNIA TIER III EMISSION CONTROL WARRANTY STATEMENT YOUR RIGHTS AND OBLIGATIONS**

The Environmental Protection Agency (EPA) and the California Air Resources Board (C.A.R.B.) and The Equipment Manufacturer are pleased to explain the emission control system warranty on your EPA Phase 2 / C.A.R.B. Tier III model year 2005 and later small off road engine (SOREs). New small off road engines must be designed, built and equipped to meet stringent EPA and C.A.R.B. anti-smog standards. Echo, Incorporated must warrant the emission control system on your small off road engine for the periods of time listed below provided there has been no abuse, neglect or improper maintenance of your small off road engine.

Your emission control system may include parts such as the carburetor or fuel injected system, and the ignition system and catalytic converter. Also included may be hoses, belts, connectors and other emission-related assemblies.

Where a warrantable condition exists, the Manufacturer will repair your small off road engine at no cost to you including diagnosis, parts and labor.

### **MANUFACTURER'S WARRANTY COVERAGE:**

The 1995 and later small off road engines are warranted for two years. If any emission-related part on your engine is defective, the part will be repaired or replaced by the Manufacturer.

### **OWNER'S WARRANTY RESPONSIBILITIES:**

- As the small off road engine owner, you are responsible for the performance of the required maintenance listed in your *Operator's Manual*. The Manufacturer recommends that you retain all receipts covering maintenance on your small off road engine, but the Manufacturer cannot deny warranty solely for the lack of receipts or for your failure to ensure the performance of all scheduled maintenance.
- As the small off road engine owner, you should however be aware that the Manufacturer may deny you warranty coverage if your small off road engine or a part has failed due to abuse, neglect, improper maintenance or unapproved modifications.

You are responsible for presenting your small off road engine to the Manufacturer's authorized service center as soon as a problem exists. The warranty repairs should be completed in a reasonable amount of time, not to exceed 30 days.

If you have any questions regarding your warranty rights and responsibilities, you should contact your Product Manufacturer.

## **EPA PHASE 2 / CALIFORNIA TIER III EMISSIONS DEFECT WARRANTY EXPLANATION**

This is additional detailed information about the EPA PHASE 2/ CALIFORNIA TIER III EMISSIONS DEFECT WARRANTY for your small off road engine.

### **WHAT DOES THIS WARRANTY COVER?**

The Manufacturer warrants that your unit was designed, built and equipped to conform with applicable California emissions standards and that your unit is free from defects in material and workmanship that would cause it to fail to conform with applicable requirements within five (5) years. *The warranty period begins on the date the product is delivered to a retail purchaser.* This is your emission control system, DEFECTS WARRANTY.

### **HOW WILL A COVERED PART BE CORRECTED?**

If there is a defect in a part covered by this warranty, a Manufacturer's Authorized Service Dealer will correct the defect.

You will not have to pay anything to have the part adjusted, repaired or replaced. This includes any labor and diagnosis for warranted repairs performed by the dealer. *In addition, engine parts not expressly covered under this warranty but whose failure is a result of a failure of a covered part will be warranted.*

Emissions System repairs covered under this warranty should be completed in a reasonable time, not to exceed 30 days.

## **IMPORTANT**

If the diagnosis reveals no defect, the emission defect warranty does not apply.

### **WHAT PARTS ARE COVERED BY THE EPA PHASE 2/ CALIFORNIA TIER III 2005 & LATER SMALL OFF ROAD ENGINE EMISSIONS DEFECT WARRANTY?**

- Any emission related part not scheduled for, "required maintenance" (See Engine Operators Manual, "SERVICE MAINTENANCE SCHEDULE") will be repaired or replaced within the warranty period. The repaired or replaced part will be warranted for the remaining Emissions Defect warranty period.
- Any emission related part scheduled for replacement during "required maintenance" (See Engine Operators Manual, "SERVICE MAINTENANCE SCHEDULE") is warranted for the period of time prior to the first scheduled replacement point for that part. Any such part repaired or replaced under warranty shall be warranted for the remainder of the period prior to the first scheduled replacement point for that part.
- Any manufacturer-approved replacement part may be used in the performance of any warranty maintenance or repairs on emission-related parts, and must be provided without charge if the part is still under warranty.
- Any replacement part that is equivalent in performance and durability may be used in non-warranty maintenance or repairs, and shall not reduce the warranty obligations of the manufacturer.
- *The owner is responsible for the performance of the required maintenance described in the operators manual.*

### **SPECIFIC EMISSION RELATED WARRANTED PARTS:**

- Choke
- Carburetor (complete assembly or replaceable components)
- Fuel Injection Assembly or replaceable components
- Air Filter
- Electronic Ignition System
- Spark Plug
- Catalytic Converter / Muffler Assembly

### **WHAT IS NOT COVERED BY THE EPA PHASE 2/CALIFORNIA TIER III 2005 & LATER SMALL OFF ROAD ENGINE EMISSIONS DEFECT WARRANTY?**

- *Any failure caused by abuse, neglect, improper maintenance.*
- *Any failure caused by unapproved modifications, use of unapproved add-on parts/modified parts or unapproved accessories.*





## LIMITED WARRANTY

MANTIS extends this limited warranty against defects in material and workmanship for a period of five (5) years under normal usage for residential purposes and two (2) years under normal usage for commercial purposes, from the date of purchase by the original purchaser.

MANTIS will repair or replace, at its option, any part or parts of the product found to be defective in material or workmanship during the warranty period. Warranty repairs and replacements will be made without charge for parts or labor. All parts replaced under warranty will be considered as part of the original product, and any warranty on the replaced parts will expire coincident with the original product warranty. If you think your MANTIS TILLER is defective in material or workmanship, please contact customer service at 800-366-6268 for the location of an authorized servicing dealer or send it, along with your proof of purchase (sales receipt) to:

Mantis  
1028 Street Road  
Southampton, PA 18966

You are responsible for pickup and delivery charges; if shipping to factory the product must be returned to us postage paid. Engines are warranted separately by the engine manufacturer

MANTIS assumes no responsibility in the event that the product was not assembled or used in compliance with any assembly, care, safety, or operating instructions contained in the Operators Manual or accompanying the product. This limited warranty does not cover damages or defects due to normal wear and tear, lack of reasonable and proper maintenance, failure to follow operating instructions or operators manual, misuse, lack of proper storage or accidents. This limited warranty shall not be effective if your Mantis tiller has been subjected to negligence or has been repaired or altered by anyone other than an authorized dealer or authorized service center.

You must maintain your MANTIS TILLER by following the maintenance procedures described in the operators manual. Such routine maintenance, whether performed by you or a dealer, is at your expense.

MANTIS MAKES NO EXPRESS OR IMPLIED WARRANTIES, REPRESENTATIONS OR PROMISES EXCEPT THOSE CONTAINED HEREIN. THERE ARE NO OTHER WARRANTIES, INCLUDING WARRANTIES OF MERCHANTABILITY AND FITNESS FOR A PARTICULAR PURPOSE. ALL WARRANTIES OTHER THAN THE EXPRESS WARRANTY SET FORTH ABOVE ARE SPECIFICALLY DISCLAIMED. THE DURATION OF ANY IMPLIED WARRANTY, INCLUDING MERCHANTABILITY AND FITNESS FOR A PARTICULAR PURPOSE, IS LIMITED TO THE DURATION OF THIS WRITTEN LIMITED WARRANTY. MANTIS DISCLAIMS ALL LIABILITY FOR INDIRECT, INCIDENTAL AND/OR CONSEQUENTIAL DAMAGES IN CONNECTION WITH THE USE OF THE MANTIS PRODUCTS COVERED BY THIS WARRANTY. SOME STATES DO NOT ALLOW LIMITATIONS ON HOW LONG AN IMPLIED WARRANTY LASTS AND/OR DO NOT ALLOW THE EXCLUSION OR LIMITATION OF INCIDENTAL OR CONSEQUENTIAL DAMAGES, SO THAT ABOVE LIMITATIONS AND EXCLUSIONS MAY NOT APPLY TO YOU. THIS WARRANTY GIVES YOU SPECIFIC LEGAL RIGHTS, AND YOU MAY ALSO HAVE OTHER RIGHTS WHICH VARY FROM STATES TO STATE.

MANTIS  
1028 Street Road  
Southampton, PA 18966  
(215) 355-9700

Specifications, descriptions, and illustrative material in this literature are as accurate as known at the time of publication, but are subject to change without notice.