

**Juno**

Project: \_\_\_\_\_

Fixture Type: \_\_\_\_\_

Location: \_\_\_\_\_

Contact/Phone: \_\_\_\_\_

# 6" VERTICAL IC COMPACT FLUORESCENT HOUSING

13W COMPACT FLUORESCENT LAMP

**ICPL613E**

## PRODUCT DESCRIPTION

ICPL, Air-Loc® single-wall construction housing • Can be completely covered with insulation • When used with Air-Loc Gasket (see accessories), stops infiltration and exfiltration of air, reducing heating and air cooling costs • Trims shown with Air-Loc symbol **AIR-LOC** do not require a gasket • Easy access ballast • 2 year warranty.

## PRODUCT SPECIFICATIONS

**Lamp** One 13W Quad or Triple (4-pin) CFL lamp.

**Socket** Supplied with spring to accommodate certain trim installations, or can be attached to top of housing for certain trims.

**Ballast** 120V HPF Rapid Start Electronic with end-of-life lamp protection • UL listed/CSA certified • Mounted to inside j-box cover for ease of maintenance.

**Trims** Trim selection shown on reverse.

**Labels** UL listed for through-branch wiring and damp locations  
 • Meets Washington State Air Tight Requirements, IECC  
 • Complies with FCC Part 18 consumer use limits • Product mechanically protected against improper use of lamps • Union made • UL and C-UL Listed • Complies with California's Title 24 energy code • Trims 239, 240, 241, 243, 271, 2330, 6101 and 9900 are wet location approved for covered ceiling applications.

**Testing** All reports are based on published industry procedures; field performance may differ from laboratory performance.

Product specifications subject to change without notice.

## INSTALLATION

**Real Nail 3 Bar Hangers** Telescoping, patent-pending Real Nail 3 system permits quick placement of housing anywhere within 24" O.C. joists or suspended ceilings • Integral T-bar notch and clip secures housing in suspended ceiling grid – no accessory clips required • 24" expansion stop allows quick placement of fixture in standard grid spacing • Bars scored in two locations for fast, clean breaking, allowing housing installation in tight applications  
 • Bars captive to mounting frame • Edge-mounted for extra strength • Captive bugle-headed ring shank nail for quick one-step installation and easy removal with claw hammer for fixture relocation • Quick-Loc slot and oversized locking set screw lock fixture in position • Bar hanger foot contoured to align to bottom of construction joist • Alternate mounting holes included.

**Junction Box** Pre-wired junction box provided with (5) ½" and (1) ¾" knockouts, (4) Non-metallic sheathed cable connectors and ground wire, UL and C-UL Listed for through-branch wiring, maximum (8) No. 12 AWG 90° C branch circuit conductors (4 in, 4 out) • Junction box provided with removable access plates • Knockouts equipped with pryout slots.

**Mounting Frame** 22-gauge die-formed galvanized steel mounting frame • Rough-in section (junction box, mounting frame, housing ballast and bar hangers) fully assembled for ease of installation.

**Housing** IC housing, .032" aluminum sealed for Air-Loc  
 • Housing is vertically adjustable to accommodate up to a 1" ceiling thickness.

REV-8/12



## DIMENSIONS

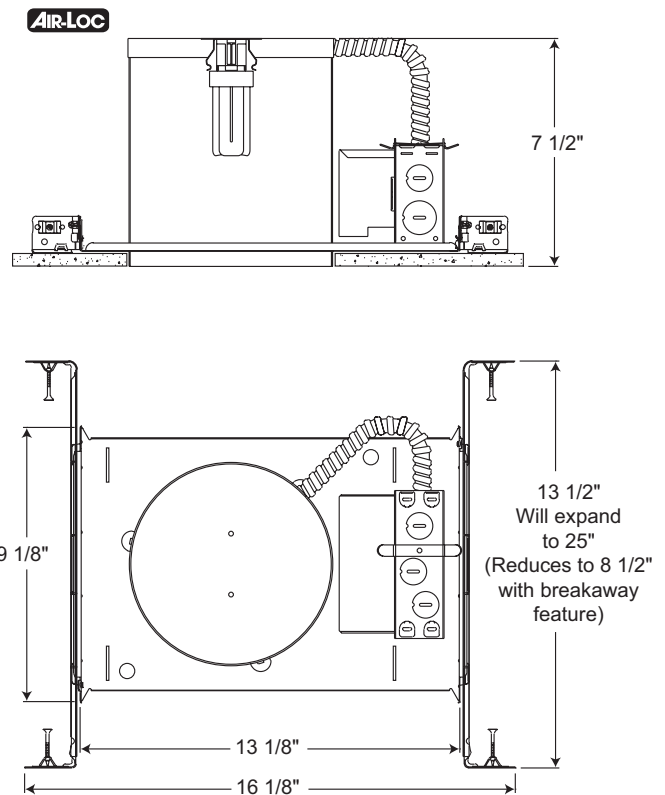

6 7/8" CEILING CUTOUT

## PRODUCT CODES

Catalog Number	Input Voltage	Lamp Rating (max.)
ICPL613E	120V	13W Quad or Triple (4-pin) CFL

## ACCESSORIES

Catalog No.	Description
ALG6	Air-Loc Gasket





















To order, specify catalog number.

# 6" VERTICAL IC COMPACT FLUORESCENT HOUSING

## 13W COMPACT FLUORESCENT LAMP

### ICPL613E

#### TRIMS/LAMPS

	Cat. No.	Description	Lamp Rating
 	<b>240-WH</b> ◆ <b>240-PW</b> ◆	Albalite with Reflector Shower/Closet Light	13W Quad or Triple (4-pin) CFL
 	<b>241-WH</b> ◆ <b>241-PW</b> ◆	Drop Opal with Reflector Shower/Closet Light	13W Quad or Triple (4-pin) CFL
	<b>28W-WH</b> <b>28B-WH</b>	Conical White Baffle Conical Black Baffle	13W Quad or Triple (4-pin) CFL
	<b>29C-WH</b> <b>29W-WH</b>	Deep Cone - Clear Deep Cone - White	13W Quad or Triple (4-pin) CFL
	<b>232C-WH</b> <b>232G-WH</b> <b>232W-WH</b> <b>232HZ-WH</b> <b>232WHZ-WH</b>	Reflector - Clear Alzak® Reflector - Gold Alzak® Reflector - Gloss White Reflector - Haze Reflector - Wheat Haze	13W Quad or Triple (4-pin) CFL
	<b>233C-WH</b>	Reflector in Clear Alzak® with Black Baffle, White Trim	13W Quad or Triple (4-pin) CFL
 	<b>239-WH</b> ◆	Frosted Lens with Reflector	13W Quad or Triple (4-pin) CFL
 	<b>243-WH</b> ◆	Decorative Swirl Etched Opal Glass	13W Quad or Triple (4-pin) CFL
 	<b>271-PW</b> ◆	Drop Opal with Reflector	13W Quad or Triple (4-pin) CFL
	<b>261W-WH</b> <b>261B-WH</b>	Scoop Wall Wash with White Baffle Scoop Wall Wash with Black Baffle	13W Quad or Triple (4-pin) CFL
 	<b>2330W-WH</b> ◆ <b>2330B-WH</b> ◆	White Baffle, Regressed Frosted Dome Lens with Reflector Black Baffle, Regressed Frosted Dome Lens with Reflector	13W Quad or Triple (4-pin) CFL
 	<b>6101-ABZ</b> ◆ <b>6101-SC</b> ◆ <b>6101-WH</b> ◆	Beveled Frame - Frosted Dome Lens with Reflector Beveled Frame - Frosted Dome Lens with Reflector Beveled Frame - Frosted Dome Lens with Reflector	13W Quad or Triple (4-pin) CFL
 	<b>9900-WH</b> ◆	Fluted Drop Opal Lens	13W Quad or Triple (4-pin) CFL

Trim Size: Catalog Numbers 28, 29, 232, 233, 239, 243, 271, 261, 9900 - 7 $\frac{5}{8}$ " O.D. Catalog Numbers 240, 241 - 8" O.D. Catalog Number 2330 - 7 $\frac{5}{8}$ " O.D. Catalog Number 6101 - 7 $\frac{1}{4}$ " O.D.  
Trim Finish: ABZ - Classic Aged Bronze, PW - Plastic White (Polycarbonate material shower trim), SC - Satin Chrome, WH - White.

Alzak is a registered trademark of Alcoa Corp.

Note: In Canada when insulation is present, Type IC fixtures must be used.

 JUNO IC housings meet IECC Energy Code requirements per ASTM E283.  
Air-Loc® rated trims are pre-gasketed for minimum air leakage with IC housings.

◆ UL Listed for use in wet location.

\*\* NOTE: TR6 Trim Ring compatible with 9900 trim.



1300 S. Wolf Road • Des Plaines, IL 60018 • Phone (847) 827-9880 • Fax (847) 827-2925  
220 Chrysler Drive • Brampton, Ontario • Canada L6S 6B6 • Phone (905) 792-7335 • Fax (905) 792-0064  
Visit us at [www.junolightinggroup.com](http://www.junolightinggroup.com)

Printed in U.S.A. ©2012 Juno Lighting, LLC.