

JUNO

2" IC 600 LUMENS LED SQUARE ADJUSTABLE

2SQA Series

Project: _____

Fixture Type: _____

Location: _____

Contact/Phone: _____



PRODUCT DESCRIPTION

2 inch square aperture recessed adjustable is IC rated for insulated or non-insulated applications • Luminaire produces up to 600 lumens and is available with optical distributions approximating that of 50W MR16 halogen lamps • Low profile form factor allows luminaire to fit in 2 x 6 construction • Designed to provide 50,000 hours of life • 5 year limited warranty on LED Components.

ENVIRONMENTALLY FRIENDLY, ENERGY EFFICIENT

- No harmful ultraviolet or infrared wavelengths
- No lead or mercury, RoHS compliant
- Comparable light output to a 50W MR16 halogen lamp

PRODUCT SPECIFICATIONS

LED Light Engine Exceptional fixture to fixture color consistency within a 3-step MacAdam ellipse • 2700K, 3000K, 3500K, and 4100K color temperatures are available with 80 CRI or 90 CRI minimum.

Modular Optics Available with field interchangeable optics in 18° Spot, 24° Narrow Flood, or 40° Flood distributions • Gimbal provides up to 35° vertical aiming and 360° horizontal aiming.

Aesthetic Trim Die cast gimbal style trims are available in white, black, satin nickel, or brushed bronze.

LED Driver Choice of dedicated 120 volt driver or universal voltage driver that accommodates input voltages from 120-277 volts AC at 50/60Hz. Power factor > 0.9. Dedicated 120 volt driver (-1) is dimmable with the use of most incandescent, magnetic low voltage and electronic low voltage dimmers • Universal voltage driver (-U) is dimmable with the use of most 0-10V protocol dimmers • For a list of compatible dimmers, see [JUNO2INCH-DIM](#).

Life Rated for 50,000 hours at 70% lumen maintenance.

Labels ENERGY STAR® Qualified • 90CRI fixtures are certified to the high efficacy requirements of California T24 • Meets energy code Air Leakage requirements per ASTM E283 • UL and cUL listed for damp locations.

Junction Box Includes (2) ½" knock-outs equipped with pryout slots • Push-in electrical connectors for field connections.

Mounting Remodel style plaster frame installs from below the ceiling and accommodates ceiling thicknesses from ½" to 1" • For thicker ceilings up to 1 ½", order 2-JCTA150 • New Construction mounting frame, 2-NCMF, is also available with Real Nail 3® telescoping bar hangers to position fixture and locate wiring prior to ceiling installation.

Product specifications subject to change without notice.



Trim Finishes

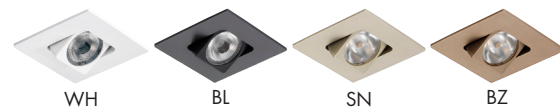

DIMENSIONS

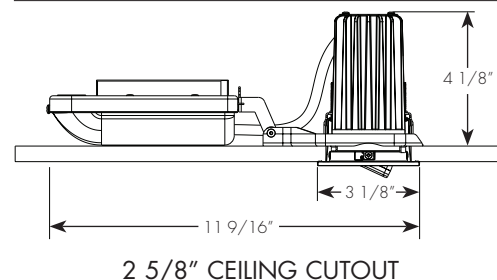

ENGINEERING DATA

	Dedicated 120V (-1)	Universal Voltage (-U)
Voltage	120	120 277
Input Power	10.1 (±5%)	9.7 9.8 (±5%)
Input Current	.09	.08 .04
Frequency	50/60Hz	50/60Hz
Power Factor	.94	.98 .98

2" IC 600 LUMENS LED SQUARE ADJUSTABLE

2SQA Series

ORDERING INFORMATION:

Example: **2SQA-927N1-WH**

Series	CRI/Color Temperature		Beam Optics	Drivers	Finish
2SQA Square Adjustable Gimbal	827 2700K, 80CRI	927 2700K, 90CRI	S 18° Spot	I Dedicated 120V Only (Forward Phase + ELV Dimmable)	WH White
	830 3000K, 80CRI	930 3000K, 90CRI	N 24° Narrow Flood	U Universal Voltage 120-277V (0-10V Dimmable)	BL Black
	835 3500K, 80CRI	935 3500K, 90CRI	F 40° Flood		SN Satin Nickel
	841 4100K, 80CRI	941 4100K, 90CRI			BZ Bronze

ACCESSORIES

Catalog No.	Description
2-NCMF	New Construction Mounting Frame with Real Nail® 3 bar hangers
2-JCTA150	Thick Ceiling adapter for 1" - 1½" thick ceiling
LEDOPTIC2-S	18° Spot Optic
LEDOPTIC2-N	24° Narrow Flood Optic
LEDOPTIC2-F	40° Flood Optic

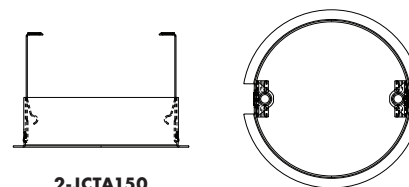
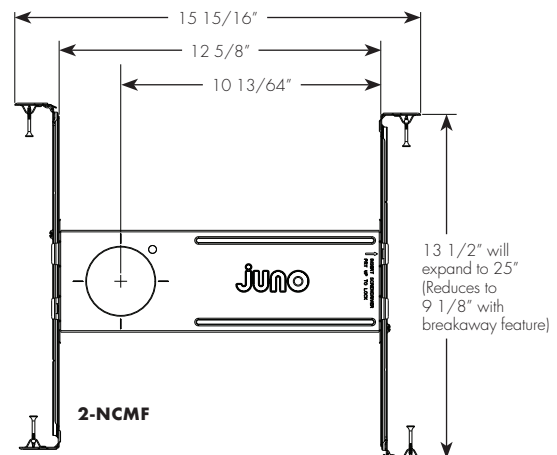

2" IC 600 LUMENS LED SQUARE ADJUSTABLE

2SQA Series

PHOTOMETRIC REPORT

Test Report#: PT01142903R

Catalog No: 2SQA-835S1-**-*

80 CRI, 3500K LED
with Spot Optic

Luminaire Spacing Criteria: 0.30

Luminaire LPW: 64

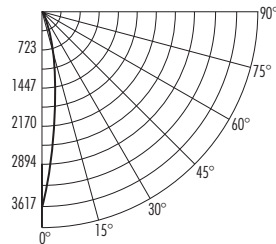

CANDLEPOWER DISTRIBUTION (Candelas)

Degrees Vertical	0°
0	3617
5	2783
15	846
25	219
35	73
45	23
55	9
65	4
75	2
85	0
90	0

AVERAGE INITIAL FOOTCANDLES Multiple Units (Square Array, 60'x60' room)

Reflectances: Ceiling 80%, Wall 50%, Floor 20%

Spacing	RCR1	RCR3	RCR5
4'	45	41	37
5'	29	26	24
6'	20	18	17
7'	16	15	13
8'	13	12	11
9'	10	9	8
10'	7	7	6

ZONAL LUMEN SUMMARY

Zone	Lumens	%Lamp	%Fixture
0-30°	564	N/A	87.5
0-40°	611	N/A	94.8
0-60°	638	N/A	99.0
0-90°	645	N/A	100.0

INITIAL FOOTCANDLES (One Unit, 10W, 16.8° Beam)

Distance to Illuminated Plane (Feet)	Footcandles Beam Center	Beam Diameter
4'	226.0	1.2
6'	100.4	1.8
8'	56.5	2.4
10'	36.2	3.0
12'	25.1	3.5

LUMINANCE (Average cd/m²)

Degrees	Average Luminance
45°	45311
55°	21484
65°	13219
75°	9522
85°	3770

PHOTOMETRIC REPORT

Test Report#: PT01142904R

Catalog No: 2SQA-835N1-**-*

80 CRI, 3500K LED
with Narrow Flood Optic

Luminaire Spacing Criteria: 0.40

Luminaire LPW: 60

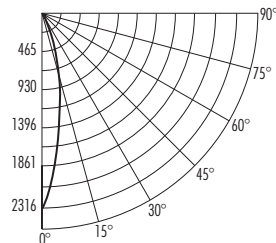

CANDLEPOWER DISTRIBUTION (Candelas)

Degrees Vertical	0°
0	2316
5	2022
15	792
25	242
35	78
45	26
55	11
65	6
75	3
85	0
90	0

AVERAGE INITIAL FOOTCANDLES Multiple Units (Square Array, 60'x60' room)

Reflectances: Ceiling 80%, Wall 50%, Floor 20%

Spacing	RCR1	RCR3	RCR5
4'	42	38	34
5'	27	24	22
6'	19	17	15
7'	15	14	12
8'	12	11	10
9'	9	8	7
10'	7	6	5

ZONAL LUMEN SUMMARY

Zone	Lumens	%Lamp	%Fixture
0-30°	511	N/A	84.8
0-40°	562	N/A	93.3
0-60°	593	N/A	98.5
0-90°	602	N/A	100.0

INITIAL FOOTCANDLES (One Unit, 10W, 23.6° Beam)

Distance to Illuminated Plane (Feet)	Footcandles Beam Center	Beam Diameter
4'	144.8	1.7
6'	64.3	2.5
8'	36.2	3.3
10'	23.2	4.2
12'	16.1	5.0

LUMINANCE (Average cd/m²)

Degrees	Average Luminance
45°	50888
55°	26354
65°	18273
75°	14601
85°	7541

PHOTOMETRIC REPORT

Test Report#: PT01142905R

Catalog No: 2SQA-835F1-**-*

80 CRI, 3500K LED
with Flood Optic

Luminaire Spacing Criteria: 0.66

Luminaire LPW: 62

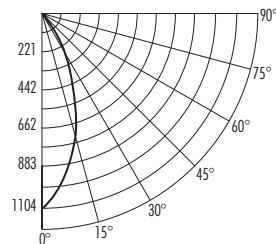

CANDLEPOWER DISTRIBUTION (Candelas)

Degrees Vertical	0°
0	1104
5	1055
15	755
25	377
35	130
45	42
55	14
65	4
75	2
85	0
90	0

AVERAGE INITIAL FOOTCANDLES Multiple Units (Square Array, 60'x60' room)

Reflectances: Ceiling 80%, Wall 50%, Floor 20%

Spacing	RCR1	RCR3	RCR5
4'	43	37	33
5'	27	24	21
6'	19	17	15
7'	15	13	12
8'	12	11	9
9'	9	8	7
10'	7	6	5

ZONAL LUMEN SUMMARY

Zone	Lumens	%Lamp	%Fixture
0-30°	478	N/A	77.6
0-40°	563	N/A	91.3
0-60°	610	N/A	98.9
0-90°	616	N/A	100.0

INITIAL FOOTCANDLES (One Unit, 10W, 40.8° Beam)

Distance to Illuminated Plane (Feet)	Footcandles Beam Center	Beam Diameter
4'	69.0	3.0
6'	30.7	4.5
8'	17.3	6.0
10'	11.0	7.4
12'	7.7	8.9

LUMINANCE (Average cd/m²)

Degrees	Average Luminance
45°	80398
55°	32943
65°	14385
75°	8253
85°	1885

Fixtures tested to IES recommended standard for solid state lighting per LM-79-08. Photometric performance on a single unit represents a baseline of performance for the fixture. Results may vary in the field.

Multiplier:	80 CRI	90 CRI
	827 = .94	927 = .83
	830 = .97	930 = .86
	835 = 1.00	935 = .88
	841 = 1.03	940 = .90



1300 S. Wolf Road • Des Plaines, IL 60018 • Phone (847) 827-9880 • Fax (847) 827-2925
220 Chrysler Drive • Brampton, Ontario • Canada L6S 6B6 • Phone (905) 792-7335 • Fax (905) 792-0064
Visit us at www.junolightinggroup.com

Printed in U.S.A. ©2015 Juno Lighting, LLC.