

8,000-35,000 RPM

PowerPRO™



VARIABLE 1.2A SPEED

Rotary Tool & Accessories



GYROS® Operation / Instruction Manual Variable Speed Rotary Tool Kit #470

Your new tool has been engineered and manufactured to GYROS® high standards for dependability, ease of operation, and operator safety. Properly cared for, it will give you years of rugged, trouble-free performance.



CAUTION: CAREFULLY READ THROUGH THIS ENTIRE OPERATOR'S MANUAL BEFORE USING YOUR NEW TOOL.

Pay close attention to the Rules for Safe Operation, Warnings, and Cautions. If you use your tool properly and only for what it is intended, you will enjoy years of safe, reliable service.

SAVE THIS MANUAL FOR FUTURE REFERENCE

TABLE OF CONTENTS

SECTION	PAGE
Technical Data	2
Rules for Safe Operation	3
General Instructions for All Power Tools	4-6
Rotary Tool Safety Rules	7
Specific Safety Instructions for Rotary Tool	8-9
<i>GyrosGuard™</i> Safety Shield Information	10
Important Safety Information	11
Functional Description and Specifications	12
Assembly Instructions	12-13
Operating Instructions	13-14
Operating Speeds	15
General Instructions For Installation of Flex Shaft	16
Specific Instructions For Flex Shaft	16
Cutting Guide Installation	16
Extendable Telescopic Tool Holder	17
Maintenance	17-18
<i>GyrosGuard™</i> Safety Shield Coupon	19
Warranty	20

TECHNICAL DATA

1.2A VARIABLE SPEED ROTARY TOOL SET





Voltage:	120v
Frequency:	60Hz
Ampere Rating:	1.2A
No Load Speed:	8,000 – 35,000 RPM
Collet Capacity:	1/32", 1/16", 3/32", 1/8"

VARIABLE SPEED ROTARY TOOL

RULES FOR SAFE OPERATION

The purpose of safety symbols is to attract your attention to possible dangers. The safety symbols, and the explanations with them, deserve your careful attention and understand-

ing. The safety warnings do not by themselves eliminate any danger. The instructions or warnings they give are not substitutes for proper accident prevention measures.

SYMBOL	MEANING
	Read the user manual before using the machine.
	Safety Alert Symbol: Indicates danger, warning, or caution, may be used in conjunction with other symbols or pictographs. Always follow the safety precautions to reduce the risk of fire, electric shock and personal injury. Note: Advises you of information or instructions vital to the operation or maintenance of the equipment.
	Wear safety goggles to protect your eyes.
	Wear ear protector to protect against noise.
	Wear dust mask to protect against dust.

IMPORTANT

Servicing requires extreme care and knowledge and should be performed only by a qualified service technician. For service we suggest you return the tool to **GYROS PRECISION TOOLS, INC.** for repair. When servicing, Use only identical **GYROS®** replacement parts.

Safe operation of this power tool requires that you read and understand this operator's manual and all labels affixed to the tool. Safety is a combination of common sense, staying alert, and knowing how our tool works.

WARNING



Do not attempt to operate this tool until you have read thoroughly and understand completely all instructions, safety rules, etc... contained in this manual. Failure to comply can result in accidents involving fire, electric shock, or serious personal injury. Save this operator's manual and review frequently for continuing safe operation and instructing others who may use this tool.

GENERAL INSTRUCTIONS FOR ALL POWER TOOLS

- **Know your power tool.** Read the operator's manual carefully. Learn the application and limitations as well as specific potential hazards related to this tool.
- **Keep guards in place and in working order.** Never operate the tool with any guard or cover removed. Make sure all guards are operating properly before each use.
- **Remove adjusting keys & wrenches.** Form a habit of checking to see keys and adjusting wrenches are removed from tool before turning it on.
- **Keep work area clean.** Cluttered work areas and workbenches invite accidents.
- **Do not use in dangerous environments.** Do not use power tools near gasoline or other flammable liquids, in damp or wet locations or expose them to rain. Keep work area well lighted.
- **Keep children and visitors away.** All visitors should wear **ANSI-Z87.1** approved safety glasses and be kept a safe distance from work area.
- **Make workshop childproof** with padlocks, master switches, or by removing starter keys.
- **Don't force the tool.** It will do the job better and safer at the rate for which it was designed.
- **Use the right tool.** Do not force the tool or attachment to do a job for which it was not designed.
- **Wear proper apparel.** Do not wear loose clothing, neckties, or jewelry that can get caught in the tool's moving parts and cause personal injury. Non-slip footwear is recommended when working outdoors. Wear protective hair covering to contain long hair.
- **Always wear ANSI-Z87.1 approved safety glasses with side shields.** Everyday eyeglasses have only impact-resistant lenses; they are **NOT** safety glasses.
- **Secure work.** Use clamps or a vise to hold work when practical. It's safer than using your hand and it frees both hands to operate the tool.
- **Do not overreach.** Keep proper footing and balance at all times.
- **Maintain tools with care.** Keep tools sharp and clean for best and safest performance. Follow instructions for lubricating and changing accessories.
- **Disconnect all tools.** When not in use, before servicing, or when changing attachments, blades, bits, cutters, etc, all tools should be disconnected from power source.
- **Reduce the risk of unintentional starting.** Be sure switch is off when plugging in.
- **Use recommended accessories.** Consult the operator's manual for recommended accessories. The use of improper accessories may cause risk of injury.

WARNING



Some dust created by power sanding, sawing grinding, drilling, and other construction activities contains chemicals known to cause cancer, birth defects or other reproductive harm. Some examples of these chemicals are:

- **Lead from lead-based paints**
- **Crystalline silica from bricks and cement and other masonry products.**
- **Arsenic and chromium from chemically treated lumber.**

Your risk from these exposures varies, depending on how often you do this type of work. To reduce your exposure to these chemicals, work in a well ventilated area, and work with approved safety equipment, such as those dust masks that are specially designed to filter out microscopic particles.

VARIABLE SPEED ROTARY TOOL

WARNING



When servicing use only identical Gyros® replacement parts. Use of any other parts may create a hazard or cause product damage.

- **Never stand on tool.** Serious injury could occur if the tool is tipped or if the drill is unintentionally contacted.
- **Never leave tool running unattended.** Turn power off. Don't leave tool until it comes to a complete stop.
- **Check damaged parts.** Before further use of the tool, a guard or other part that is damaged should be carefully checked to determine that it will operate properly and perform its intended function. Check for alignment of moving parts, binding or moving parts, breakage of parts, mounting and any other conditions that may affect its operation. A guard or other part that is damaged must be properly repaired or replaced **by an authorized service center to avoid risk of personal injury.**
- **Protect your hearing.** Wear hearing protection during extended periods of operation.
- **Keep tools dry, clean, and free from oil and grease.** Always use a clean cloth when cleaning. Never use brake fluids, gasoline, petroleum-based products, or any solvents to clean tool.
- **PROTECT YOUR LUNGS.** Wear a face or dust mask if the operation is dusty.
- **Guard against electrical shock by preventing body contact with grounded surfaces.** For example: pipes, radiators, ranges, and refrigerator enclosures.
- Inspect tool cords and extension cords periodically and, if damaged, have repaired by a qualified service technician. Stay constantly aware of cord location and keep it away from the rotating wheel.
- **Never use in an explosive atmosphere.** Normal sparking of the motor could ignite fumes.
- Use only outdoor extension cords with approved ground connection that are intended for use outdoors and so marked.
- Avoid awkward operations and hand positions where a sudden slip could cause your hand to move into the drill. **ALWAYS** make sure you have good balance.
- Allow the motor to come up to full speed before starting a cut to avoid binding or stalling.
- Do not use tool if switch does not turn it on and off. Have defective switches replaced **by an authorized service center.**
- **Replacement parts.** All repairs, whether electrical or mechanical, should be made by a qualified service technician at an authorized service center.
- **Keep hands away from working area.** Do not hand hold pieces so small that your fingers go under the tool. Do not reach underneath work or in tool path with your hand or fingers for any reason.
- Before using the tool, be sure all adjustments are secure.
- Do not remove jammed cut-off pieces until tool rotation has stopped.
- Never start the tool when the accessory is in contact with the work piece.
- Never touch the rotating portion of the tool or other moving parts during use.

WARNING



DO NOT OPERATE THIS TOOL WHILE UNDER THE INFLUENCE OF DRUGS, ALCOHOL OR ANY MEDICATION THAT MAY IMPAIR YOUR JUDGEMENT OR CONTROL!



- Before changing the setup, removing cover, guards or blades, **UNPLUG** the tool and be sure the switch is in the **"OFF"** position.
- Always turn off tool before disconnecting it to avoid accidental starting when reconnecting to a power source.
- Stay alert and exercise control. Watch what you are doing and use common sense. **DO NOT** operate tool when tired. **DO NOT RUSH!**
- Make sure work area has ample lighting to see the work and that no obstructions will interfere with safe operation **BEFORE** performing any work using this tool.
- **Save the instructions.** Refer to them frequently and use them to instruct other users.

If you loan someone this tool, loan him or her these instructions also.

- **Use proper extension cord.** Make sure your extension cord is in good condition. When using an extension cord, be sure to use one heavy enough to carry the current your product will draw. An undersized cord will cause a drop in line voltage resulting in loss of power and overheating. A wire gauge size (A.W.G.) of at least 16 is recommended for an extension cord 25 feet or less in length. If in doubt, use the next heavier gauge. The smaller the Gauge number, the heavier the cord.
- **Don't abuse cord.** Never carry tool by cord or yank it to disconnect from receptacle. Keep cord away from heat, oil and sharp edges.

TOOL USE AND CARE

Use clamps or other practical way to secure and support the work piece to a stable platform. Holding the work by hand or against your body is unstable and may lead to loss of control.

Do not force tool. Use correct tool for application. The correct tool will do the job better and safer at the rate for which it is designed.

Do not use tool if switch does not turn it "ON or "OFF". Any tool that cannot be controlled with the switch is dangerous and must be repaired.

Disconnect the plug from the power source before making any adjustments, changing accessories, or storing the tool. Such preventative safety measures reduce the risk of starting the tool accidentally.

Store idle tools out of reach of children and other untrained persons. Tools are dangerous in the hands of untrained users.

Maintain tools with care. Keep cutting tools sharp and clean. Properly maintained tools, with sharp cutting edges are less likely to bind and are easier to control. Any alteration or modification is a misuse and may result in a dangerous condition.

Check for misalignment or binding of moving parts, breakage of parts, and other conditions that may affect the tool operation. If damaged, have the tool serviced before using. Poorly maintained tools cause many accidents. Develop a periodic maintenance schedule for your tool.

Use only accessories that are recommended by the manufacturer for your model. Accessories that are suitable for one tool, may become hazardous when used on another tool.

SAVE THESE INSTRUCTIONS

VARIABLE SPEED ROTARY TOOL

PowerPro™ ROTARY TOOL SAFETY RULES

WARNING



READ AND UNDERSTAND ALL INSTRUCTIONS. FAILURE TO FOLLOW ALL INSTRUCTIONS LISTED BELOW, MAY RESULT IN ELECTRIC SHOCK, FIRE AND/OR SERIOUS PERSONAL INJURY.

WORK AREA

Keep your work area clean and well lit. Cluttered benches & dark areas invite accidents.

Do not operate power tools in explosive atmospheres, such as in the presence of flammable liquids, gases or dust. Power tools create sparks, which may ignite the dust or fumes.

Keep by-standers, children and visitors away while operating a power tool. Distraction can cause you to lose control.

ELECTRICAL SAFETY

Double Insulated tools are equipped with a polarized plug (one blade is wider than the other.) This plug will fit in a polarized outlet only one way. If the plug does not fit fully in the outlet, reverse the plug. If it still does not fit, contract a qualified electrician to install a polarized outlet. Do not change the plug in any way. Double insulation eliminates the need for a three wire grounded power supply system. Before plugging in the tool, be certain the outlet's supplied voltage is within the voltage marked on the nameplate. Do not use "AC Only" rated tools with a DC Power supply.

Avoid body contact with grounded surfaces such as pipes, radiators, ranges and refrigerators. There is an increased risk of electric shock if your body is grounded. If operating the power tool in damp locations is unavoidable, a Ground Fault Circuit Interrupter must be used to supply the power to your tool. Electrician's rubber gloves and footwear will further enhance personal safety.

Don't expose power tools to rain or wet conditions. Water entering a power tool will increase the risk of electric shock.

Do not abuse the cord. Never use the cord

to carry the tools or pull the plug from an outlet. Keep cord away from heat, oil, sharp edges or moving parts. Replace damaged cords immediately. Damaged cords increase the risk of electric shock.

When operating a tool outside, use an outdoor extension cord marked "W-A" or "W". These cords are rated for outdoor use and reduce the risk of electric shock. Refer to "Recommended sizes of Extension Cords" in the Maintenance section of this manual.

PERSONAL SAFETY

Stay alert, watch what you are doing and use common sense when operating a power tool. Do not use while tired or under the influence of drugs, alcohol, or medication. A moment of inattention while operating power tools may result in serious injury.

Dress properly. Do not wear loose clothing or jewelry. Contain long hair. Keep hair, clothing, and gloves away from moving parts. Loose clothes, jewelry, or long hair can be caught in moving parts. Keep handles dry, clean and free from oil and grease.

Avoid accidental starting. Be sure switch is "OFF" before plugging in. Carrying tools with your finger on the switch or plugging in tools that have the switch on invites accidents.

Remove adjusting keys or wrenches before turning the tool "ON". A wrench or key that is left attached to a rotating part of the tool may result in personal injury.

Do not overreach. Keep proper footing and balance at all times. Proper footing and balance enables better control of the tool in unexpected situations.

Use safety equipment. Always wear eye protection. Dust mask, non-skid safety shoes, hardhat, or hearing protection must be used for appropriate conditions.

SPECIFIC SAFETY INSTRUCTIONS FOR THE VARIABLE SPEED ROTARY TOOL

Accessories must be rated for at least the speed recommended on the tool warning label. Wheels and other accessories running over rated speed can fly apart and cause injury.

Hold tool by insulated gripping surfaces when performing an operation where the cutting tool may contact hidden wiring or its own cord. Contact with a “live” wire will make exposed metal parts of the tool “live” and shock the operator. If cutting into existing walls or other blind areas where electrical wiring may exist is unavoidable, disconnect all fuses or circuit breakers feeding this worksite.

Always disconnect the power cord from the power source before making any adjustments or attaching any accessories. You may unexpectedly cause the tool to start leading to serious personal injury.

Be aware of the switch location, when placing the tool down or picking the tool up. You may accidentally activate the switch.

Always hold the piece firmly in your hands during the start-up. The reaction torque of the motor, as it accelerates to full speed, can cause the shaft to twist.

Always wear safety goggles and dust mask. Use only in well ventilated area. Using personal safety devices and working in a safe environment reduces risk of injury.

After changing the bits or making any adjustments, make sure the collet nut and other adjustment devices are securely tightened. Loose adjustment device can unexpectedly shift, causing loss of control; loose rotating components will be violently thrown.

Do not reach in the area of the spinning bit. The proximity of the spinning bit to your hand may always be obvious.

Allow brushes to run at operating speed for at least one minute before using wheel. During this time no one is to stand in front or inline with the brush. Loose bristles or wires will be discharged during run-in time.

Wire and bristle brushes must never be operated at speeds higher than 15,000/min. Direct the discharge of the spinning wire brush away from you. Small particles and tiny wire fragments may discharge at high velocity during the “cleaning” action with these brushes and may become imbedded in your skin. Bristles or wires will be discharged from brush at high speeds.

Wear protective gloves and face shield with wire or bristle brushes. Apply wire or bristle brushes lightly to the work as only the tip of the wires/bristles do the work. “Heavy” pressure on bristles will cause the wires or bristles to become overstressed, resulting in a whipping action and will cause wire/bristles to be discharged.

Carefully handle both the tool and individual grinding wheels to avoid chipping or cracking. Install a new wheel if tool is dropped while grinding. Do not use a wheel that may be damaged. Fragments from a wheel that bursts during operation will fly away at great velocity possibly striking you or bystanders.

Never use dull or damaged bits. Sharp bits must be handled with care. Damaged bits can snap during use. Dull bits require more force to push the tool, possibly causing the bit to break.

VARIABLE SPEED ROTARY TOOL

Use clamps to support work piece whenever practical. Never hold a small work piece in one hand and tool in the other while in use. Allow for sufficient space, at least 6", between your hand and spinning bit. Round material such as dowel rods, pipes or tubing may have tendency to roll while being cut, and may cause the bit to "bite" or jump toward you. Clamping a small work piece allows you to use both hands to control the tool.

Inspect your work piece before cutting. When cutting irregularly shaped work-pieces, plan your work so it will not slip and pinch the bit and be torn from your hand. For example, if carving wood, make sure there are no nails or foreign objects in the work piece. Nails or foreign objects can cause the bit to jump.

Never start the tool when bit is engaged in the material. The cutting edge may grab the material causing loss of control of the cutter.

Avoid bouncing and snagging the wheel, especially when working corners, sharp edges etc. This can cause loss of control and kick-back.

The direction of feed with the bit into the material when carving, routing or cutting is very important. Always feed the bit into the material in the same direction as the cutting edge is exiting from the material (which is the same direction the chips are thrown). Feeding the tool in the wrong direction, causes the cutting edge of the bit to climb out of the work and pull the tool in the direction of this feed.

If the work piece or bit becomes jammed or bogged down, turn the tool "OFF" by the switch. Wait for all moving parts to stop and unplug the tool, then work to free the jammed material. If the switch to the tool is left "ON" the tool could restart unexpectedly causing serious personal injury.

Do not leave a running tool unattended, turn power off. Only when tool comes to a complete stop is it safe to put it down.

Do not grind or sand near flammable materials. Sparks from the wheel could ignite these materials.

Do not touch the bit or collet after use. After use the bit and collet are too hot to be touched by bare hands.

Regularly clean the tool's air vents by compressed air. Excessive accumulation of powdered metal inside the motor housing may cause electrical failures.

Do not allow familiarity gained from frequent use of your rotary tool to become commonplace. Always remember that a careless fraction of a second is sufficient to inflict severe injury.

Do not alter or misuse tool. Any alteration or modification is a misuse and may result in serious personal injury.

This product is not intended for use as a dental drill, in human or veterinary medical applications. Serious personal injury may result.

When using the steel saws, cutoff wheels, high speed cutters or tungsten carbide cutters, always have the work securely clamped. Never attempt to hold the work with one hand while using any of these accessories. The reason is that these wheels will grab if they become slightly canted in the groove, and can kickback-causing loss of control resulting in serious injury. Your second hand should be used to steady and guide the hand holding the tool. When a cutoff wheel grabs, the wheel itself usually breaks. When the steel saws, high speed cutters or tungsten carbide cutters grab, they may jump from the groove and you can lose control of the tool.

GYROS *guard*[™] ROTARY TOOL SAFETY SHIELDS

VIEW OUR
SPECIAL OFFER
ON P.19

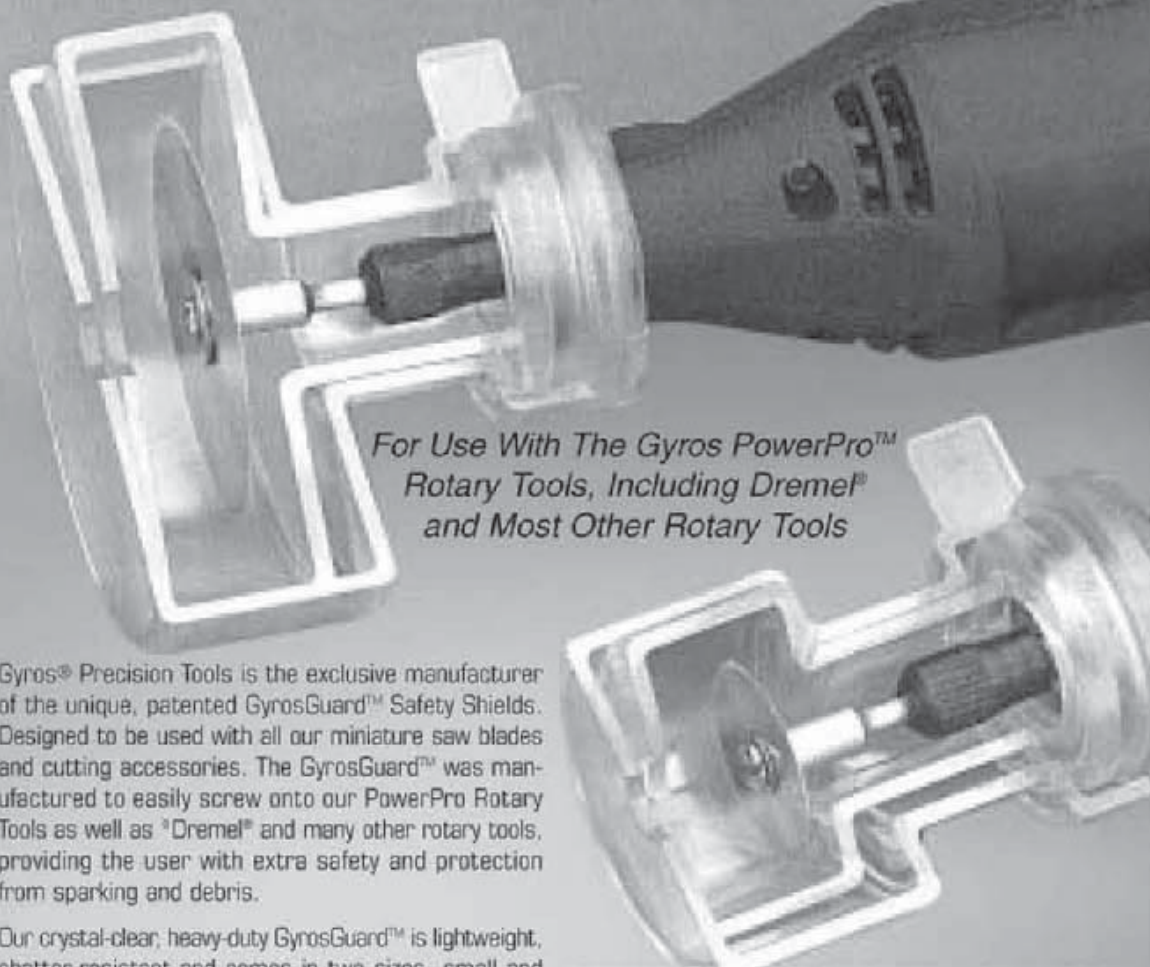

*For Use With The Gyros PowerPro[™]
Rotary Tools, Including Dremel[®]
and Most Other Rotary Tools*

Gyros® Precision Tools is the exclusive manufacturer of the unique, patented GyrosGuard[™] Safety Shields. Designed to be used with all our miniature saw blades and cutting accessories. The GyrosGuard[™] was manufactured to easily screw onto our PowerPro Rotary Tools as well as [®]Dremel[®] and many other rotary tools, providing the user with extra safety and protection from sparking and debris.

Our crystal-clear, heavy-duty GyrosGuard[™] is lightweight, shatter-resistant and comes in two sizes—small and large. The standard sized GyrosGuard[™] makes it easier to access those hard to reach areas with a diameter capacity up to 1-1/2". The large sized GyrosGuard[™] will accommodate even our largest 2-1/2" diameter cutting accessories. The spring-loaded, self-closing design offers protection from debris and sparking. The access hole allows easy replacement of accessories without removal of the GyrosGuard[™].

The GyrosGuard[™] reflects Gyros® continuing commitment to safety awareness, state-of-the-art quality, and customer satisfaction.

50-12510 GYROSGUARD[™] SMALL SIZE

UPC #780670 51101 2
0" to 1-1/2" Diameter Capacity
2-3/4" Length — 2-3/8" OD

50-25010 GYROSGUARD LS[™] LARGE SIZE

UPC #780670 51201 9
0" to 2-1/2" Diameter Capacity
2-3/4" Length — 3-1/4" OD

**Dremel[®] is a registered trademark of the
Robert Bosch Tool Corp.*

VARIABLE SPEED ROTARY TOOL

A WORD ABOUT SAFETY

WARNING



Serious eye or hand injuries can result from the improper selection or use of power tool accessories. When properly used, all Gyros accessories can be operated at the speed rating indicated. Always follow these guidelines:

- **ALWAYS** use the GyrosGuard™ Safety Shield with all applicable accessories
- **ALWAYS** wear proper eye or face protection while using any accessory
- **ALWAYS** ensure that the machine used does not subject abrasive wheels to speeds greater than the maximum RPM marked on the wheel or package
- **ALWAYS** seat the shanks of the mandrels or mounted points into the collet or chuck of the handpiece as far as possible to provide proper support
- **NEVER** operate an accessory at speeds above maximum rated speeds
- **NEVER** use, nor continue to use, any accessory that appears to be out of balance, loose, damaged or vibrating
- **NEVER** use excessive side pressure, which might tend to vibrate or break the shank or the cutting accessory, causing breakage and flying debris. Let the speed of the accessory perform the work

Safety requirements for the use, care, and protection of abrasive wheels are contained in ANSI standards B7.1-1978, which are available from ANSI, 1430 Broadway, New York, NY 10018.

SAFETY SHIELD REQUIRED USAGE:

- **NEVER USE THE GYROS ROTARY TOOLS WITHOUT THE GYROSGUARD SAFETY SHIELD IN PLACE** for all applicable accessories
- **NEVER USE ANY METHOD TO LOCK** guard in the open position
- The spring-loaded, self-closing mechanism is there for your convenience only. **DO NOT** depend on it alone for your safety
- **ALWAYS** wear safety glasses or face shield and protective clothing when operating any rotary tools

FUNCTIONAL DESCRIPTION AND SPECIFICATIONS



WARNING: Disconnect the plug from the power source before making any assembly, adjustments or changing accessories. Such preventive safety measures reduce the risk of starting the tool accidentally.

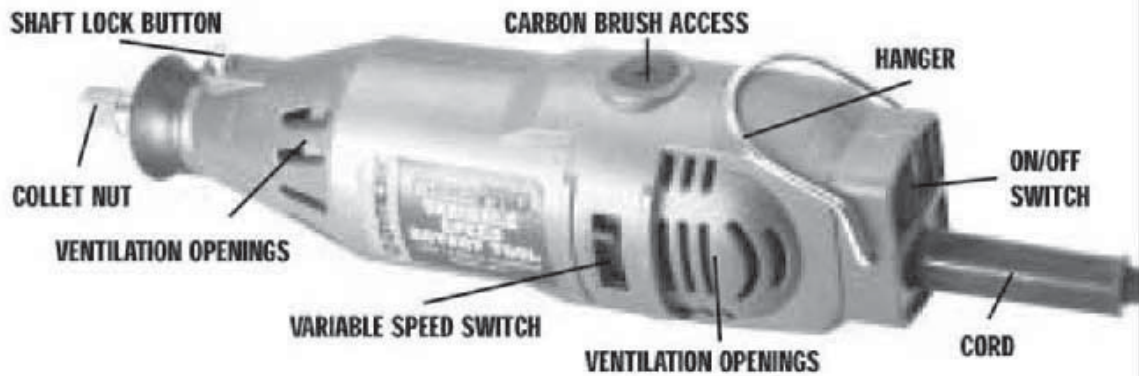

LIST OF PARTS

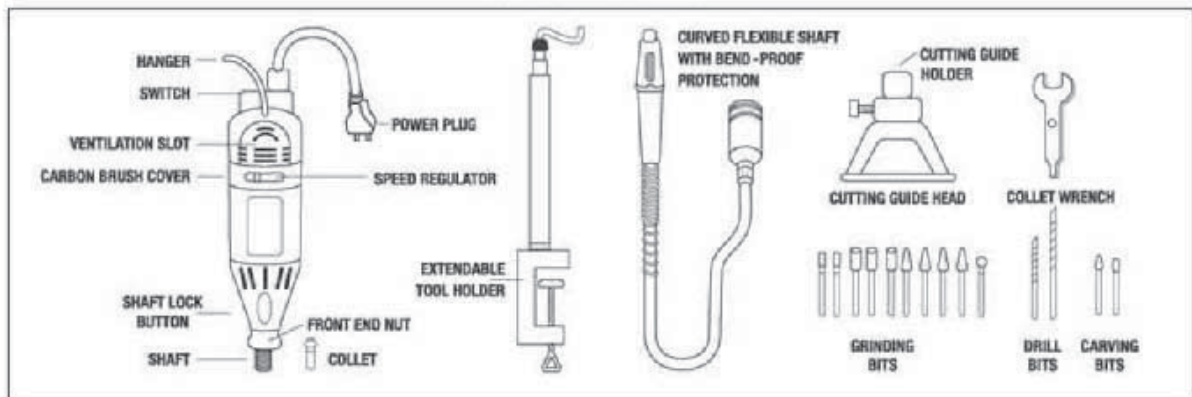

ASSEMBLY INSTRUCTIONS

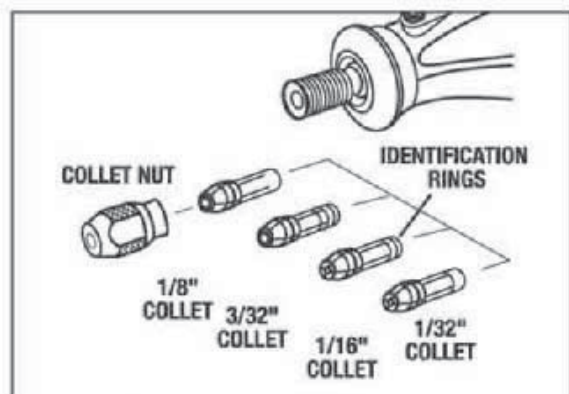
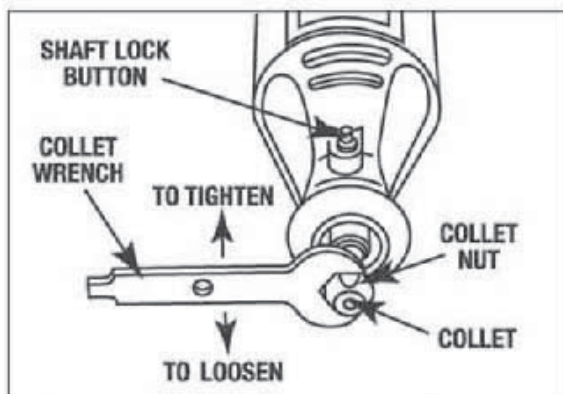

WARNING Always unplug Rotary Tool before changing accessories, changing collets or servicing your Rotary Tool.

COLLET NUT - To loosen, first press shaft lock button and rotate the shaft by hand until the lock engages the shaft preventing further rotation.

CAUTION: Do not engage lock while the rotary tool is running.

VARIABLE SPEED ROTARY TOOL

With the shaft lock engaged, use the collet wrench to loosen the collet nut if necessary. The collet nut must be loosely threaded on when inserting an accessory. Change accessories by inserting the new one into the collet as far as possible to minimize run out and unbalance. With the shaft lock engaged, finger tighten the collet nut until the accessory shank is gripped by the collet. **Avoid excessive tightening of the collet nut when there is no bit inserted.**

COLLETS - Four different size collets (see illustration), to accommodate different shank sizes, are available for your Rotary Tool. To install a different collet, remove the collet nut and remove the old collet. Insert the unslotted end of the collet in the hole at the end of the tool shaft. Replace collet nut on the shaft.

CAUTION: Always use the collet that matches the shank size of the accessory you plan to use. Never force a larger diameter shank into the collet.

Note: Some rotary tool kits may not include all four collets sizes.

BALANCING ACCESSORIES - For precision work, it is important that all accessories be in good balance (much the same as the tires on your automobile). To true up or balance an accessory, slightly loosen collet nut and give the accessory or collet a 1/4 turn.

Retighten collet nut and run the Rotary Tool. You should be able to tell by the sound and feel if the accessory is in balance. Continue adjusting in this fashion until best balance is achieved. To maintain balance on abrasive wheel points, before each use, with the wheel point secured in the collet, turn on the Rotary Tool and run a Dressing Stone lightly against the revolving wheel point. This removes high spots and trues up the wheel point for good balance.

The hanger is provided for the use of hanging your tool while using the flex-shaft or for storage. If you do not use the hanger, remove it from the tool and snap it back into place underneath the cord so it will be out of the way while the tool is in use.

OPERATING INSTRUCTIONS

The Rotary Tool is a handful of high-speed power. It serves as a carver, grinder, polisher, sander, cutter, power brush, drill and more.

The Rotary Tool has a small, powerful electric universal motor, is comfortable in the hand, and is made to accept a large variety of accessories including abrasive wheels, drill bits, wire brushes, polishers, engraving cutters, router bits, cutting wheels and attachments. Accessories come in a variety of shapes and permit you to do a number of different jobs. As you become familiar with the range of accessories and their uses, you will learn just how versatile the rotary tool is. You'll see dozens of uses you haven't thought of before.

The real secret of the Rotary Tool is its speed. To understand the advantages of its high speed, you have to know that the standard portable electric drill runs as speeds up to 2,800 revolutions per minute. The Rotary Tool operates at speeds up to 35,000 revolutions per minute. The typical electric drill is a low speed, high-torque tool; the Rotary Tool is just the opposite - a high speed, low torque

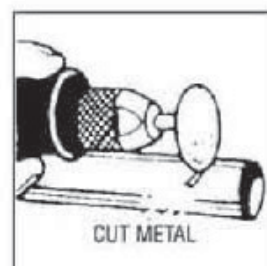
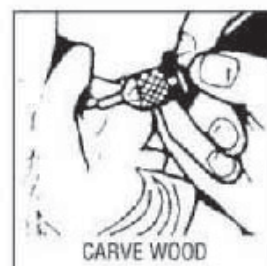
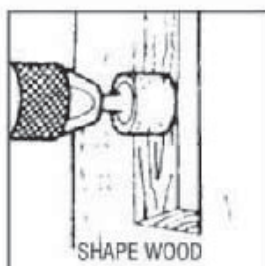
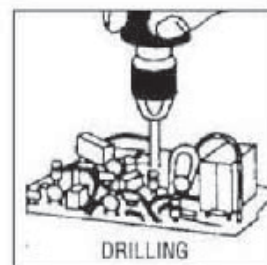

OPERATING INSTRUCTIONS

tool. The major difference to the user is that the high speed, combined with the accessory mounted in the collet does the work. You don't apply pressure to the tool, but simply hold and guide it. In the low speed tools, you not only guide the tool, but also apply pressure to it, as you do, for example, when drilling a hole.

It is high speed, along with its compact size and wide variety of special accessories and attachments, which makes the Rotary Tool different from other tools. The speed enables it to do jobs low speed tools cannot do, such as cutting hardened steel, engraving glass, etc.

Getting the most out of your Rotary Tool is a matter of learning how to let this speed work for you. To learn about more uses and the versatility of GYROS® accessories and attachments refer to this Owner's Manual

USING YOUR ROTARY TOOL

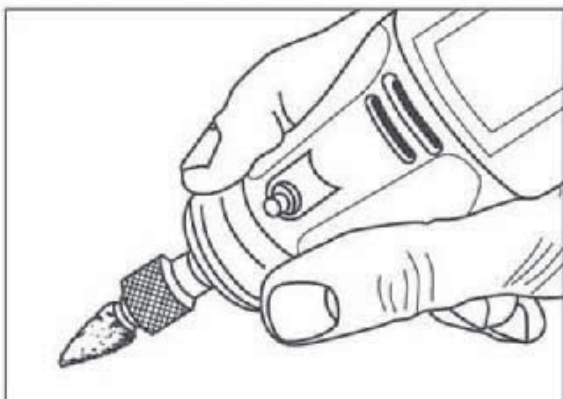

The first step in learning to use the Rotary Tool is to get the "feel" of it. Hold it in your hand and feel its weight and balance. Feel

the taper of the housing. This taper permits the Rotary Tool to be grasped much like a pen or pencil. The #470 Variable Speed tool has a unique comfort grip on the nose and back seating, which allows the user added comfort and control during use. You can feel the difference!

For best control in close work, grip the Rotary Tool like a pencil between your thumb and forefinger.

Always hold the tool away from your face. Accessories can be damaged during handling, and can fly apart as they come up to speed. This is not common, but does happen.

Practice on scrap materials first to see how the Rotary Tool's high-speed action performs. Keep in mind that the work is done by the speed in the tool and by the accessory in the collet. You should not lean on or push the tool during use. Instead, lower the spinning accessory lightly to work and allow it to touch the point at which you want cutting (or sanding or etching, etc.) to begin. Concentrate on guiding the tool over the work using very little pressure from your hand. Allow the accessory to do the work.

Usually, it is best to make a series of passes with the tool rather than attempt to do all the work in one pass. To make a cut, for example, pass the tool back and forth over the work, much as you would a small paintbrush. Cut a little material on each pass until you reach desired depth. For most work, the gentle touch is best. With it, you have the best control, are less likely to make errors and will get the most efficient work out of the accessory.

CAUTION



WHENEVER YOU HOLD THE TOOL, BE CAREFUL NOT TO COVER THE AIR VENT WITH YOUR HAND. THIS BLOCKS THE AIR FLOW AND CAUSES THE MOTOR TO OVERHEAT.



WARNING

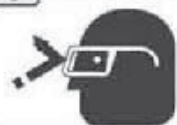

WEAR EYE PROTECTION

VARIABLE SPEED ROTARY TOOL

OPERATING SPEEDS

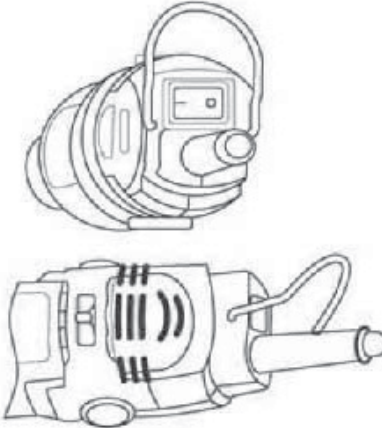

SWITCH ON/OFF
Only when the switch is at "OFF" state, can the multifunctional tool be switched on. The data of power supply should be identical with that on the nameplate.

SWITCH ON
Push the switch at **I** Position

SWITCH OFF
Push the switch at **O** Position

ADJUSTMENT OF SPEED
You can easily adjust the speed of the tool. Start at low speed, then increase gradually until the best speed is reached.

Set the speed indicator to fit the job; to achieve the best results when working with different materials, the speed of the Rotary Tool should be regulated.

To select the right speed for each job, use a practice piece of material. Vary speed to find the best speed for the accessory you are using and the job to be done.

On the variable speed model, there are switch-setting indicators marked with a line. Slide to the appropriate setting on the housing to select the operating speed needed from 8,000 – 35,000 RPM.

NEEDS FOR SLOWER SPEEDS

Certain materials, however, (some plastics and precious metals, for example) require a relatively slow speed because at high speed the friction of the accessory generates heat and may cause damage to the material.

Slow speeds (15,000 RPM or less) usually are best for polishing operations employing the felt polishing accessories. They may also be best for delicate projects as "egger" work,

delicate woodcarving and fragile models parts. (All brushing applications require lower speeds to avoid wire discharge from the holder.)

NEEDS FOR HIGHER SPEEDS

Higher speeds are better for carving, cutting, routing, shaping, and cutting dadoes or rabbets in wood.

Hardwoods, metals and glass require high-speed operation, and drilling should be at high speed.

The speed of the Rotary Tool is controlled by setting the indicator on the housing.

BONUS FEATURE:

This rotary tool has been specifically designed with an independent on/off switch, and speed control switch. This allows the user to set the desired speed for the particular job he is working on and the next time the machine is turned on to continue working, the desired speed can remain intact. **In this way, this machine provides the advantages that both a single-speed and variable speed machine offers!**

GENERAL INSTRUCTIONS FOR INSTALLATION OF FLEXIBLE SHAFT

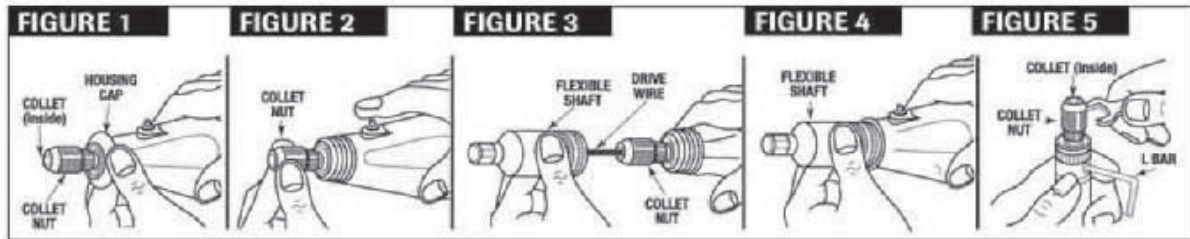

FIG 1 Unscrew and remove the housing cap from the body of the machine.

FIG 2 Press the shaft lock button and loosen the collet nut, without removing it from the motor shaft.

FIG 3 Pull the drive wire out of the flexible shaft 2" to 3", and slide it into the collet. Press the shaft lock button and finger tighten the collet nut. Then tighten slightly with the wrench provided. **DO NOT OVER-TIGHTEN.**

FIG 4 Attach by screwing the collar of the flexible shaft onto the rotary tool.

FIG 5 To attach accessories to the flexible shaft spindle, insert the "L" bar (provided) into the hole on the side of the spindle to keep it from turning, and use the collet wrench to loosen the collet nut.



CAUTION

FLEXIBLE SHAFT LUBRICATION

The flex-shaft should be lubricated after every 25-30 hours of use. To lubricate, unscrew the flex-shaft assembly from the motor housing. Pull the center core out of the flex-shaft assembly. Wipe a very thin film automotive wheel bearing grease onto the center core and reinsert it back into the shaft. **To prevent damage to the tool, do not over-grease shaft. Too much grease will cause the unit to overheat. Re-attach the flex-shaft to the rotary tool.**

SPECIFIC INSTRUCTIONS FOR FLEXIBLE SHAFT

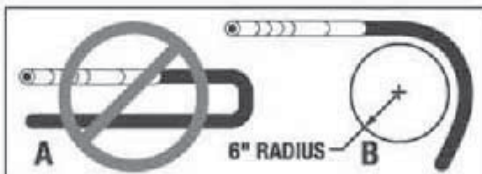

Do not operate the flexible shaft with a sharp bend. Over bending the shaft can generate excessive heat on the jacket or hand piece. The recommended minimum is 6" radius.

CUTTING GUIDE INSTALLATION

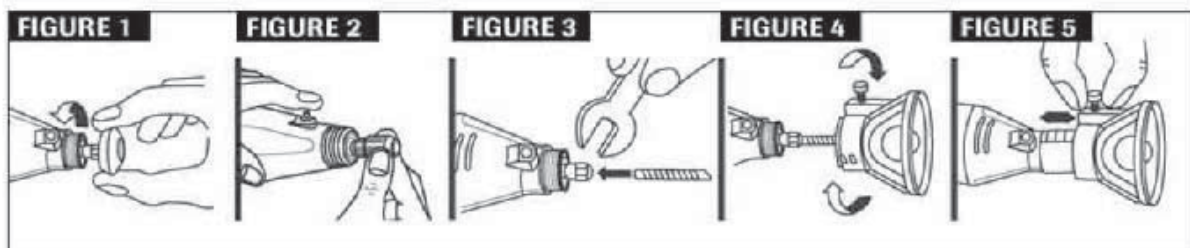

FIG 1 Unscrew and remove housing cap from the body of the rotary tool.

FIG 2 Press the shaft lock button and loosen the collet nut, without removing it from the motor shaft.

FIG 3 Slide desired tool bit into the collet, press shaft lock button and finger tighten the collet nut. Tighten slightly with wrench (provided). **DO NOT OVER-TIGHTEN.**

FIG 4 Proceed to install cutting guide by screwing guide onto tool clockwise to tighten.

FIG 5 Loosen mounted screw on cutting guide and adjust tool to depth desired for application. Tighten by hand to maintain position.

VARIABLE SPEED ROTARY TOOL

EXTENDABLE TELESCOPIC TOOLHOLDER

If connecting the Rotary Tool with the Flexible Shaft, you can hang the tool on the extendable tool holder, thus the working range can be freer and vibration will not be transmitted from the tool to the working table.

- Rotary Tool can be fixed and hung up
- Adjustable height from 8in. to 21 in.
- Maximum thickness of fixed working table 2.35 in.
- Hanger can rotate 360°



By fixing screws at the base of the work table, adjust the extendable toolholder on the edge of the work table. In order to insure the connection between the tool and the tool holder, be sure to adjust tightly. Turn the extendable pole clockwise so you can lock the desired height into place. Turn counterclockwise and the extendable pole can be loosened.

EZ-LITE™



Some work may require additional illumination for which a special EZ-Lite™ is provided. To attach the EZ-Lite™ to the tool, remove existing collar from the tool and attach the EZ-Lite™. To activate the light collar turn the small on/off switch located on the EZ-Lite™

MAINTENANCE

SERVICE

Preventive maintenance performed by unauthorized personnel may result in misplacing of internal wires and components which can cause serious hazard.

CARBON BRUSHES

The brushes and commutator in your tool have been engineered for many hours of dependable service. In order to prepare your brushes for use, run your tool at full speed for 5 minutes under no load. This will properly "seat" your brushes, which extends the life of both your brushes and your tool. To maintain peak efficiency of the motor, we recommend every 50-60 hours the brushes be examined.

MAINTENANCE OF REPLACEABLE BRUSHES

The brushes should be inspected frequently when tools are used continuously. If your tool runs sporadically, loses power, makes unusual noises or runs at a reduced speed, check the brushes. To continue using the tool in this condition will permanently damage your tool.

With the cord unplugged, remove the brush caps one at a time with a small screwdriver

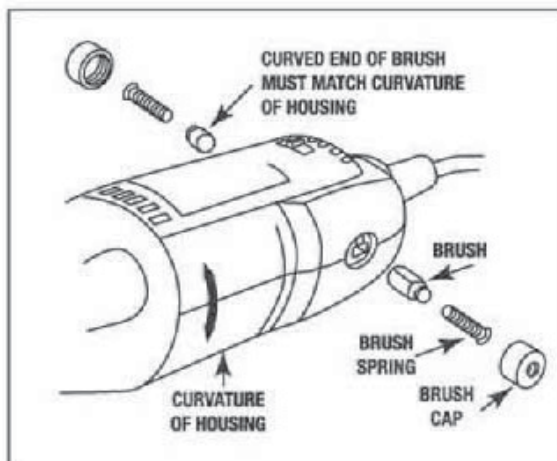

by rotating cap counter-clockwise and check each brush.

If the brush is less than 1/8" long and the end surface of the brush that contacts the commutator is rough and/or pitted, they should be replaced. Check both brushes.

Usually the brushes will not wear out simultaneously. If one brush is worn out, replace both brushes. Make sure the brushes are installed as illustrated. The curved surface of the brush must match the curvature of the commutator. After replacing brushes the

tool should be run at no-load; place it on a clean surface and run it freely at full speed for 5 minutes before loading (or using) the tool. This will allow the brushes to "seat" properly and will give you more hours of life from each set of brushes. This will also extend the total life of your tool since the commutator surface will "wear" longer.

BEARINGS

Under normal use the double ball bearing will not require lubrication.

CLEANING



WARNING: To avoid accidents always disconnect the tool from

the power supply before cleaning or performing any maintenance. The tool may be cleaned most effectively with compressed dry air. **Always wear safety goggles when cleaning tools with compressed air.**

Ventilation opening and switch levers must be kept clean and free of foreign matter. Do not attempt to clean by inserting pointed objects through openings.

Certain cleaning agents and solvents damage plastic parts. Some of these are: gasoline, carbon tetrachloride, chlorinated cleaning solvents, ammonia and household detergents that contain ammonia.

EXTENSION CORDS

If an extension cord is necessary, a cord with adequate size conductors that is capable of carrying the current necessary for your tool must be used. This will prevent excessive voltage drop, loss of power or overheating. Grounded tools must use 3-wire extension cords that have three prong plugs and receptacles.

RECOMMENDED SIZES OF EXTENTION CORDS 120-VOLT ALTERNATING CURRENT TOOLS

Ampere Ratings	Cord Size in A.W.G.				Wire Sizes in mm ²			
	Cord Length in Feet				Cord Length in Meters			
	25	50	100	150	15	30	60	120
3 - 6	18	16	16	14	.75	.75	1.5	2.5
6 - 8	18	16	14	12	.75	1.0	2.5	4.0
8 - 10	18	16	14	12	.75	1.0	2.5	4.0
10 - 12	16	16	14	12	1.0	2.5	4.0	-
12 - 16	14	12	-	-	-	-	-	-

SERVICE

Tool service must be preformed by qualified repair personnel only. Service or maintenance preformed by unqualified personnel could result in risk of injury. For example: internal may be misplaced or pinched, safety guard springs may be improperly mounted.

When servicing a tool, use only identical replacement parts. Follow instructions in the Maintenance section of this manual Use of unauthorized parts or failure to follow Maintenance Instructions may create a risk of electric shock or injury. Certain cleaning agents such as gasoline, carbon tetrachloride, ammonia, etc. may damage plastic parts.