

## 200 Watt Off-Grid Charging Kit (GS-200-KIT)

### Quick Connect Guide

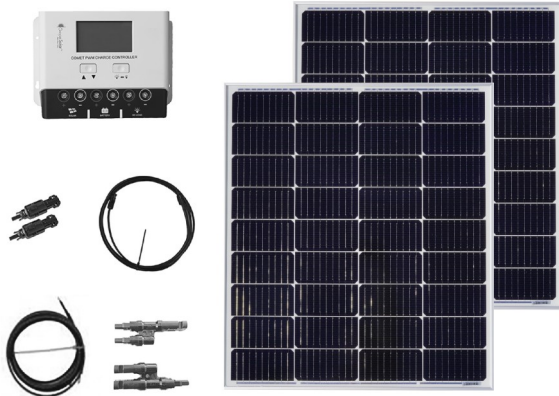

**IMPORTANT:** Please read GS-PWM-COMET-40 charge controller owner's manual and GS-STAR-100W connection guide (included with products) before assembling kit.

For additional information about Grape Solar products:  
email [Support@GrapeSolar.com](mailto:Support@GrapeSolar.com), or  
call **1-877-264-1014** for live telephone support.

To estimate how much average monthly power this system should produce in your area, please use the **PV Watts Calculator** found at:

<https://pwwatts.nrel.gov/>

This System Size= 0.2 kW DC

*(only applicable for zip codes in the U.S.A.)*

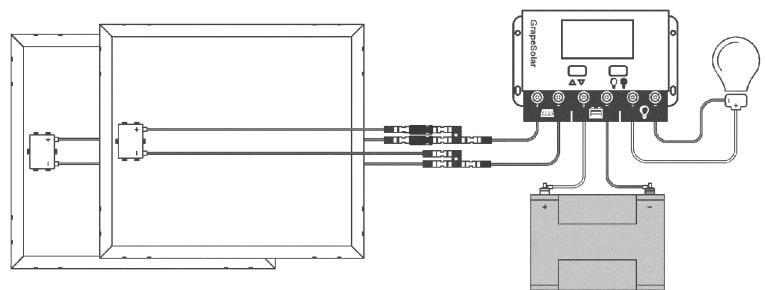

[diagrams not to scale]

### 1 Check your order to make sure that all parts are included:

- ❶ GS-PWM-Comet 40 Charge Controller
- ❷ 2x GS- STAR-100W Solar Panel
- ❸ 2x 15-Amp MC4 In-Line Fuse
- ❹ MC4 Branch Connector Set
- ❺ 5-Foot Red/Black Ring-lug Cable Pair
- ❻ 15-foot MC4 Cable

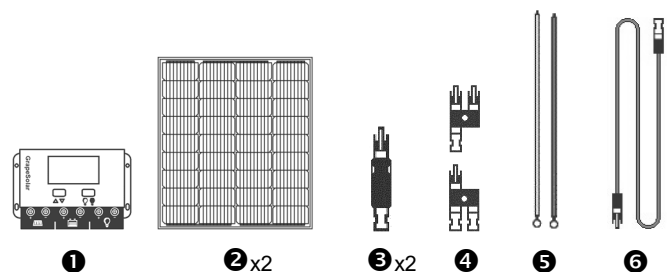

[diagrams not to scale]

Additional tools and equipment you will need:

- Screwdriver– Philips Head
- Wire Stripper/Cutter
- 12-Volt Deep-Cycle Battery Bank
- Voltmeter (for Troubleshooting)

**2** Mount the 100-watt solar panels **2** so that they are facing due South at approximately the same angle as your latitude. The ideal area has full sun and no shading. If the following connections are made during daylight, cover the panels with cardboard, cloth, or a similar opaque material so that the panel does not output power.

**3** Connect the bare wire end of the red battery cable **5** to the “+ BATTERY” terminal on the bottom of the Comet-40 charge controller **1**. Connect the bare wire end of the 5-foot black cable **5** to the “- BATTERY” terminal. A Phillips head screwdriver can be used to loosen and tighten the screw clamps onto the wires.

Attach the ring lug end of the red cable **5** to the positive terminal of a 12V deep cycle battery. Attach the ring lug end of the black cables **5** to the negative terminal of the battery.

The charge controller **1** display screen will be visible if the battery has sufficient charge. If the display screen is not visible, the battery must be charged from an another source. The charge controller, which regulates solar power flow to the battery, is powered by the battery.

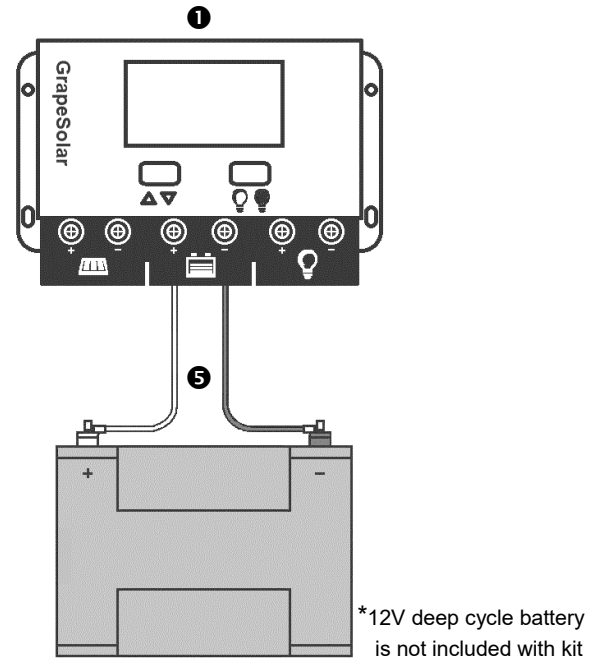

**4** Using wire cutters, snip the 10-gauge, 15ft. MC4 extension cable **6** into two equal halves (7.5ft each.) On the cut ends, strip off ¼-inch of insulation, revealing bare wire.

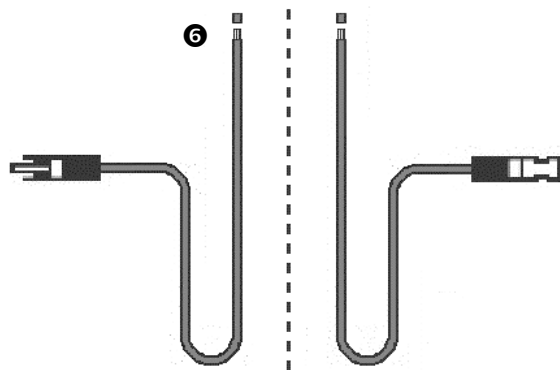

**5** Connect the single-input side of each Branch Connector **4** to the compatible MC4 ends of the halved cable **6**. On the branch connector of the “female” MC4 ends, connect both MC4 In-line Fuses **3**.

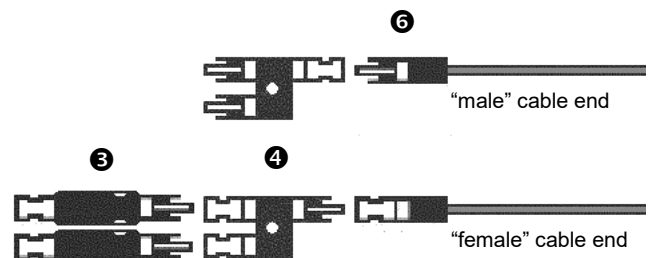

- 6** Connect the positive panel cables **2** to the “female” fuse ends **3** from the previous connections. (TIP: to help distinguish the two bare wire ends, place a piece of tape on this bare wire end **6** deriving from this positive solar output.)

Connect the negative panel cables **2** to the “male” branch connector ends **4** of the other MC4 cable half **6**.

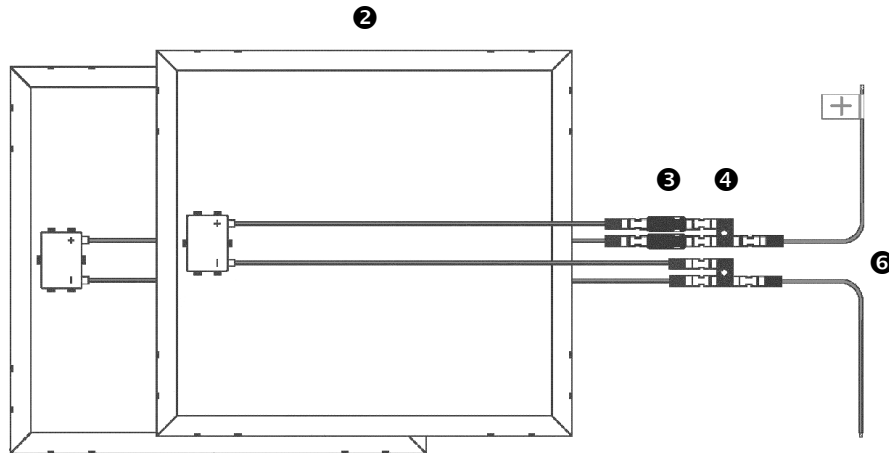

- 7** Connect the positive bare wire end **6** to the “+” PV input of the charge controller **1**.  
Connect the negative bare wire end **6** to the “-” PV input of the charge controller **1**.

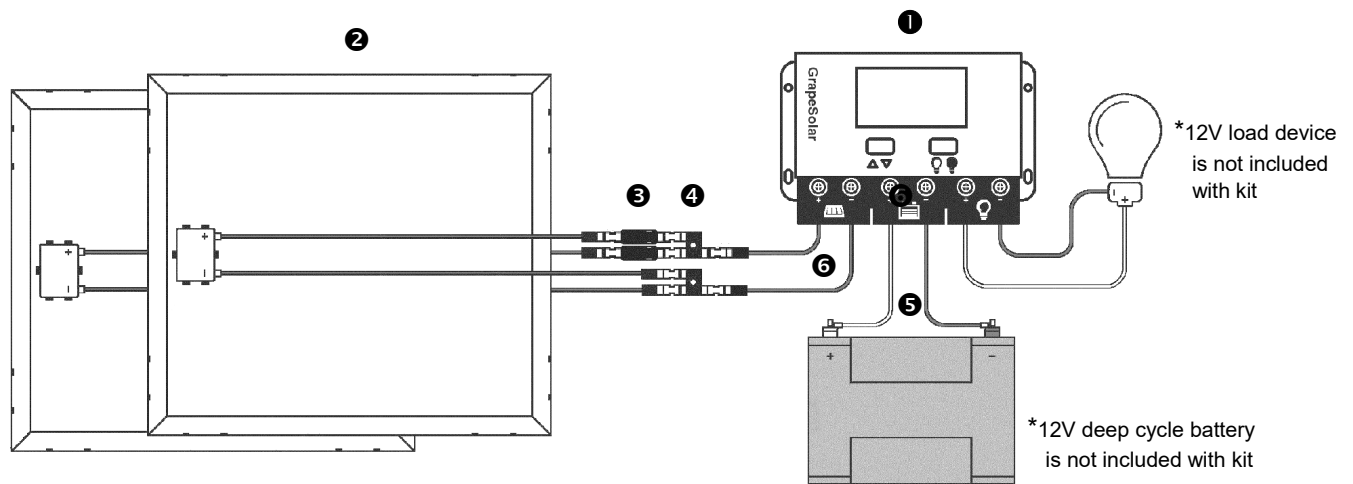

- 8** Remove the panel covering. In good sunlight, the charge controller’s **1** “BAT %” should increase to 100%. When the controller is set to “LOAD ON,” the system will provide power through the load control output or through the USB port.

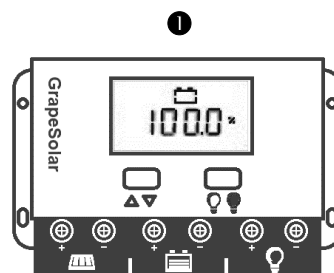

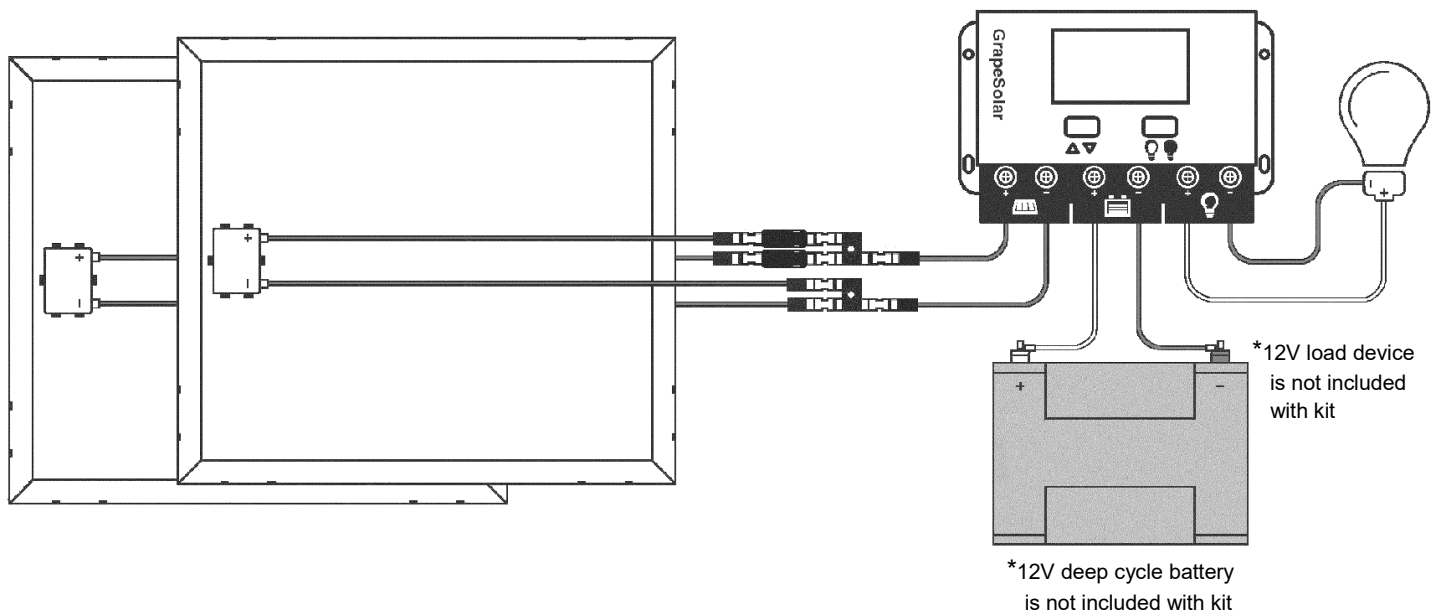

**DISCLAIMER:**

Installations of this kit could be subject to national and local building and electrical codes. Installers should have adequate knowledge of national and local code to ensure the installation passes inspection by the local electric authority.

Proper fuses or breakers should be used to comply with all local and national codes. Contact Grape Solar for specific recommendations.

All batteries used for this system should be identical. Do not mix battery types or sizes. Do not mix old batteries with new batteries. Performance and charging anomalies can occur if types, sizes, or age of batteries are not identical.

Grape Solar does not warrant the accuracy, sufficiency, or suitability to all customers of any technical or other information provided in product manuals. Grape Solar does not claim any responsibility or liability for losses, damages, costs or other expenses whether special, indirect, consequential or incidental, which might arise out of the use of such information.