

Assembly Instructions

MFR# 9V320V48

Bathroom vanity

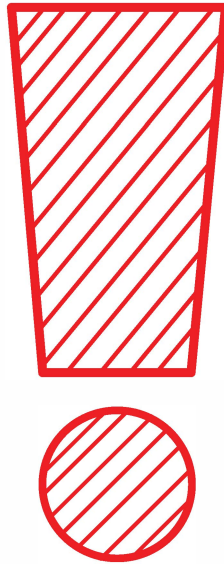

IMPORTANT, RETAIN FOR FUTURE REFERENCE: READ CAREFULLY
For more information, visit: **www.northridge-home.com**

For parts or customer service call: **1-866-387-8065**

Or email: **info@northridge-home.com**

(English, French and Spanish languages spoken)

Monday-Friday 8am - 8pm (EST).

Telephone number is only valid in the United States and Canada.

WARNING: Small parts choking hazard

Care & Cleaning

- Manufacturer recommends not to use any chemicals to clean this product. Use only soft, damp cloth for cleaning
 - Vanity is for indoor use only; Temperature and humidity should be regulated
 - Avoid direct sunlight as it can cause fading
- Countertop spills should be cleaned up immediately with a soft cloth and warm water. Be careful not to spill or use any acidic or caustic substances or any petroleum-based product.

MADE IN VIETNAM

A x 1

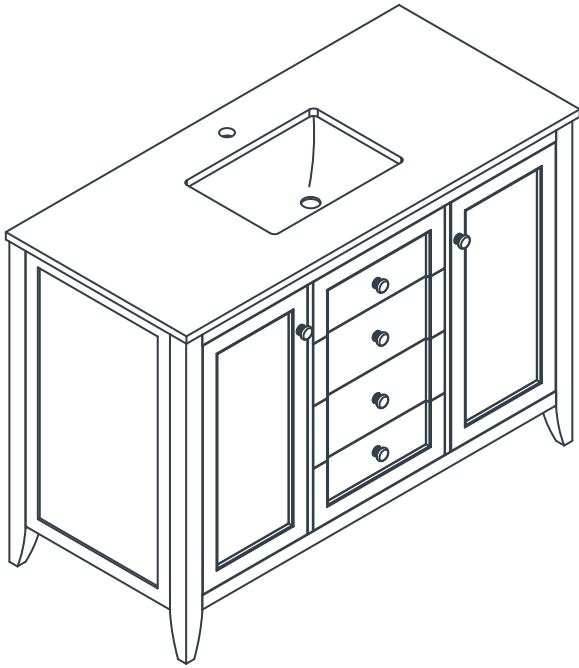

B x 1

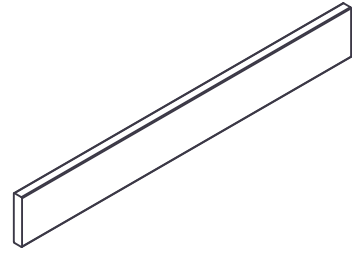

Installation requires thin-set adhesive for backsplash (not included)

Touch-up pen



NOTE: It is suggested that this product be installed by a professional and be permanently attached to the wall. Not intended to be a free-standing unit.

Tools needed (not included)



1

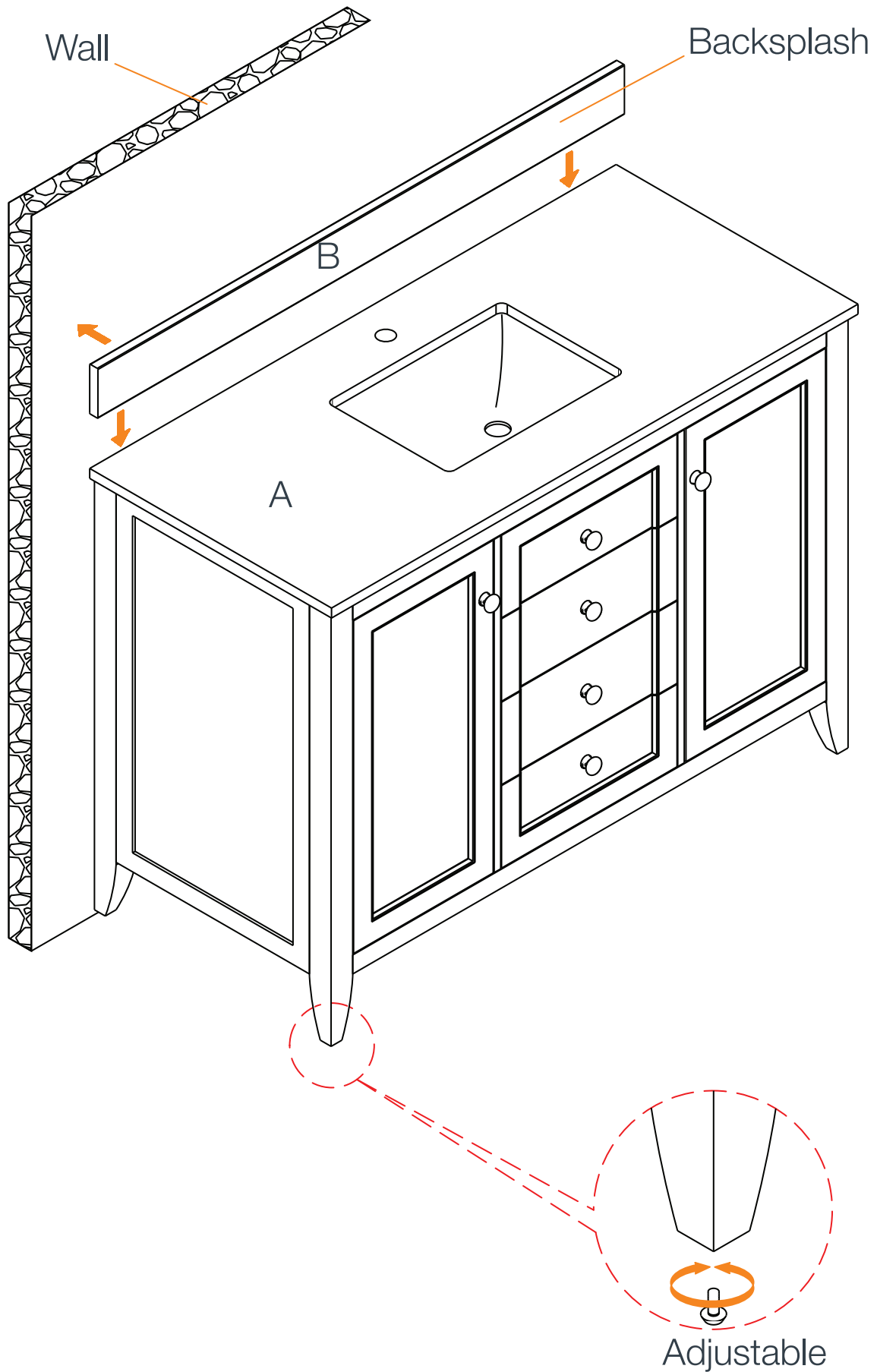

For application of backsplash (B) to drywall: Make sure the wall is smooth and flat. Clean the wall and the back of the backsplash (B) with damp cloth to remove any grease or debris. Apply thin-set adhesive, and then set the backsplash (B).

2

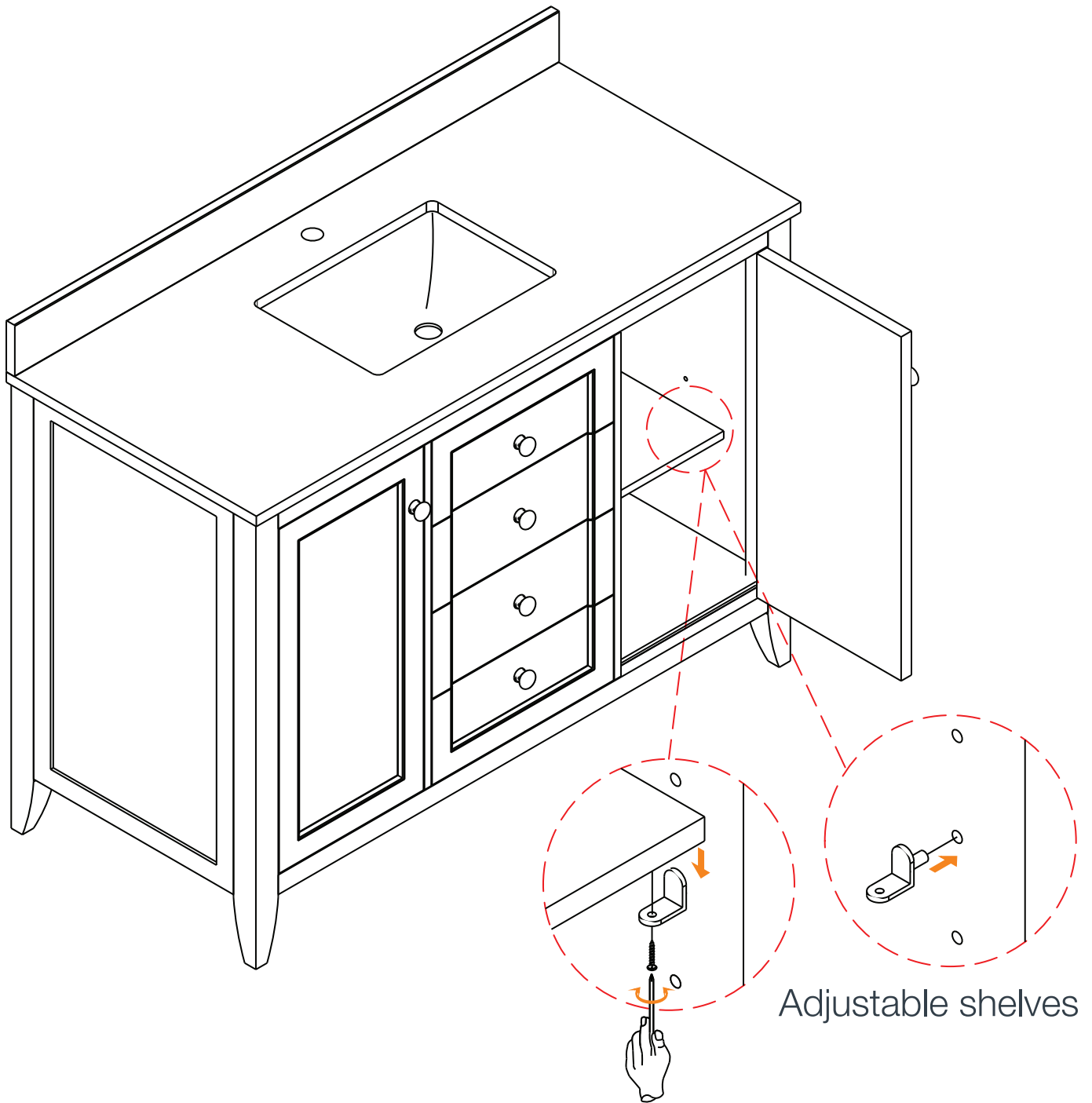

- To adjust the shelves, follow the below steps:
1. Remove the screws from the Adjustable Shelf.
 2. Reposition the Shelf Pins into the desired position.
 3. Place the Adjustable Shelf back onto the Shelf Pins.

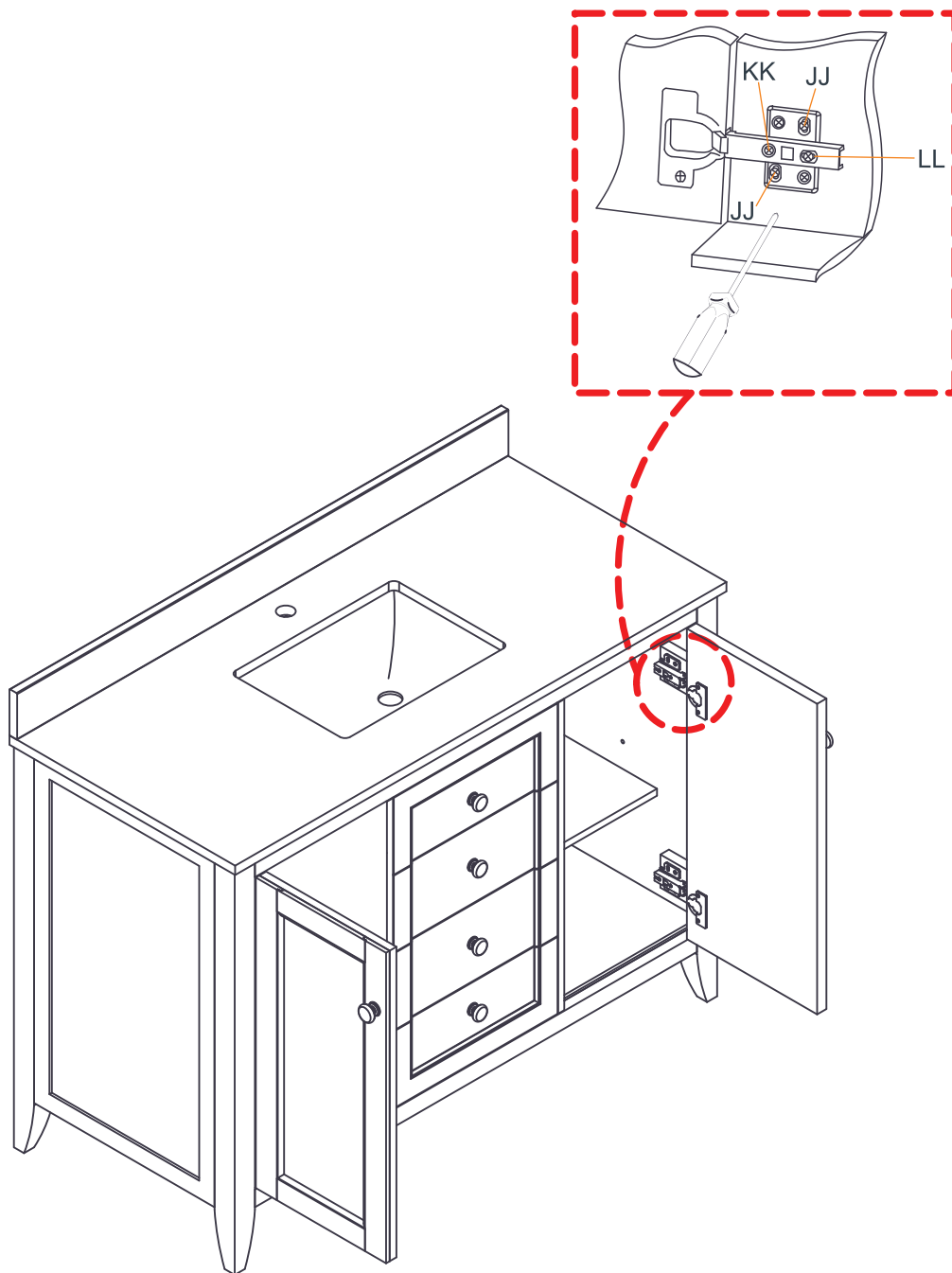

Uneven floor may cause doors to hang incorrectly. Please place the vanity on level surface, or adjust the levelers at the bottom to ensure that it is perfectly level. If necessary, doors can be adjusted with a Philips screwdriver at the adjustable hinges.

KK: To adjust door left or right.



LL: To adjust door forward or backward.



JJ: To adjust door up or down.



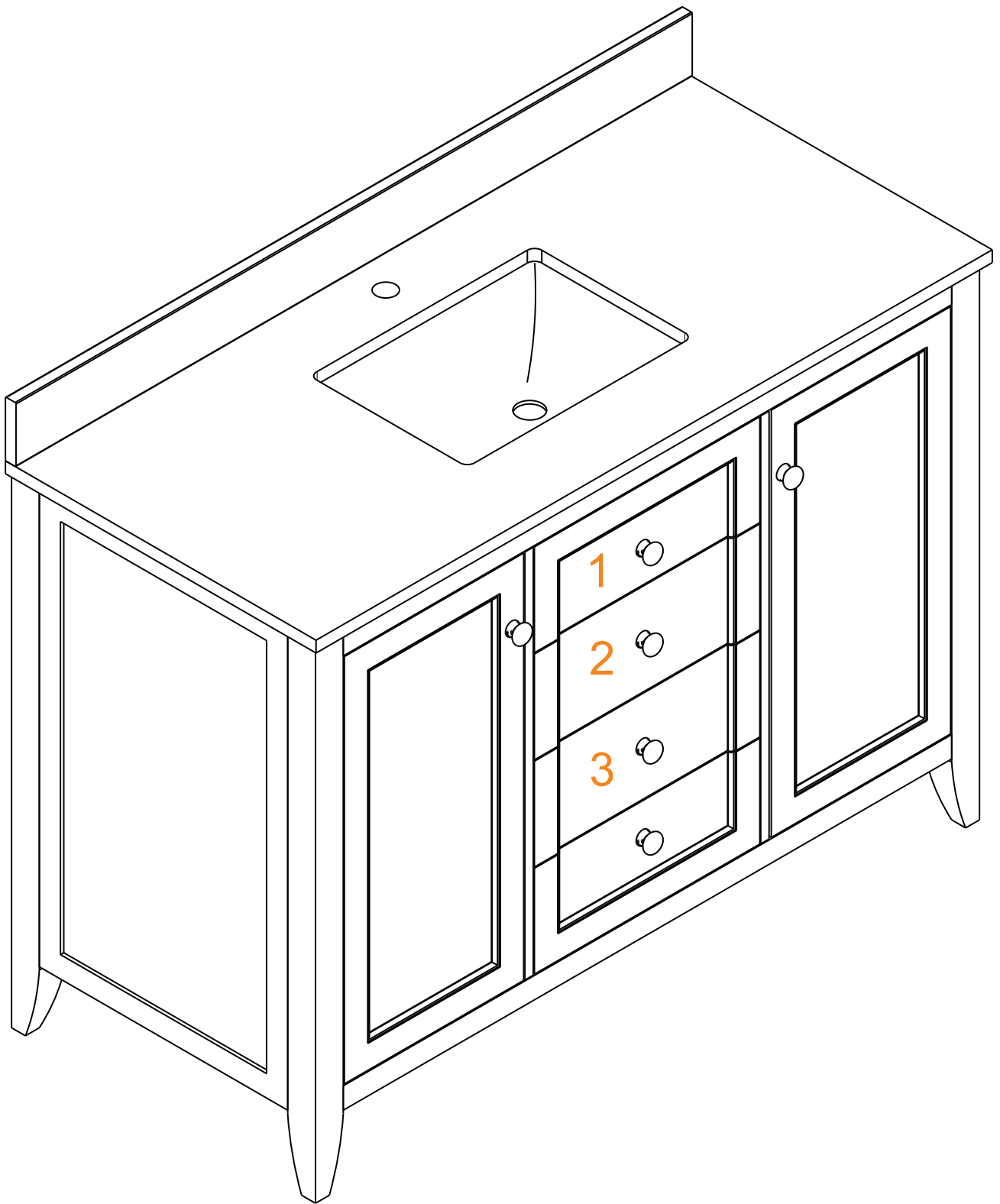

In case drawers need to be removed, each drawer is individually numbered underneath the drawer box with the corresponding number on top of the dust partition, inside the case.

To install drawer:

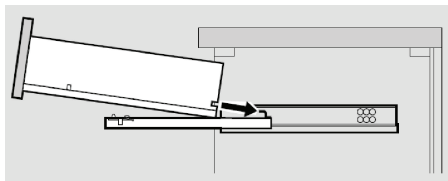

Place the drawer on the runner.

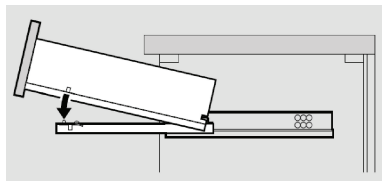

Pull forward until the peg engages with the fixing holes in the drawer base.

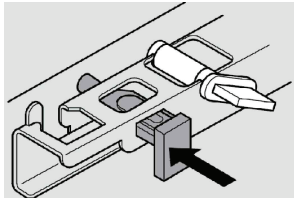

Lock the peg by pushing inside the hole in the drawer base side.

To remove drawer:

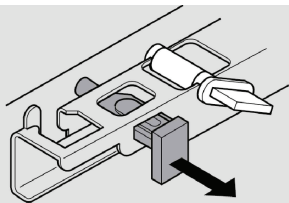

Open the lock by pushing the peg out of the hole.

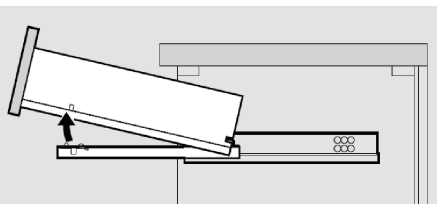

Pull the peg out of the fixing holes in the drawer base.

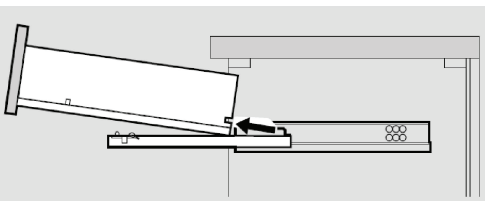

Pull all of the drawers out of the case.

Toolless height adjustment:

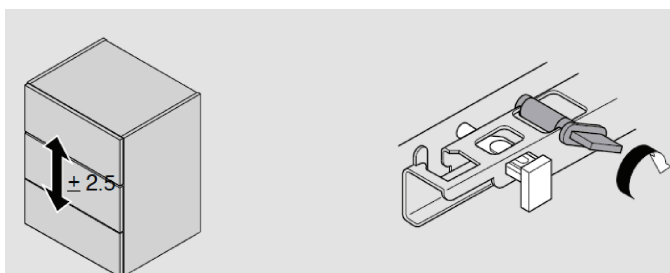

Turn the lock next to the peg from left to right.