



ALWAYS AT YOUR COMMAND

Models 2022/2024/2042

GARAGE DOOR OPENERS

**Includes: 2-Bulb Light System
Wall Console**

**Installer:
Leave this manual
with homeowner.**

Includes INTELLICODE® Remote Control
Safe-T-Beam® System must be installed to close door.

For use only with sectional doors.

Homelink® and Car2U® compatible

For Answers and Assistance:

1.800.354.3643

or visit www.geniecompany.com

SAVE THIS MANUAL FOR FUTURE REFERENCE

Homelink® is a registered trademark of
Johnson Controls Technology Company.

Car2U® is a registered trademark of
Lear Corporation.

© The Genie Company 2012.

PN 37026501206, 1/27/2012

SAFETY INFORMATION



OVERVIEW OF POTENTIAL HAZARDS READ THIS SAFETY INFORMATION

Garage doors are large, heavy objects that move with the help of springs under high tension and electric motors. Since moving objects, springs under tension, and electric motors can cause injuries, your safety and the safety of others depend on the owner or user of this system to read, understand and implement the information in this manual. If you have questions or do NOT understand the information presented, contact The Genie Company or an authorized Genie® Dealer.

The safety alert symbol and following signal words **DANGER**, **WARNING**, and **CAUTION** are used throughout this manual to call attention to and identify different levels of hazard and special instructions.

 This is the safety alert symbol. This symbol is placed next to signal words and messages to help you identify important safety information

The word:

-  **DANGER** indicates an imminently hazardous situation which, if NOT avoided, will result in death or serious injury.
-  **WARNING** indicates a potentially hazardous situation which, if NOT avoided, could result in death or serious injury.
-  **CAUTION** indicates a potentially hazardous situation which, if NOT avoided, may result in injury or property damage.

The word **NOTE** is used to indicate important steps to be followed, important considerations, or location of parts.

IMPORTANT SAFETY INSTRUCTIONS READ AND FOLLOW ALL INSTRUCTIONS SAVE THESE INSTRUCTIONS







POTENTIAL HAZARD	EFFECT	PREVENTION
 MOVING DOOR	 WARNING: Could result in Death or Serious Injury	Keep people clear of opening while door is moving. Do NOT allow children to play with the door operator. Do NOT operate a door that jams or one that has a broken spring.
 ELECTRICAL SHOCK	 WARNING: Could result in Death or Serious Injury	Turn OFF power before removing operator cover. When replacing cover, make sure wires are not pinched or near moving parts. Operator must be properly grounded.
 HIGH SPRING TENSION	 WARNING: Could result in Death or Serious Injury	Do NOT try to remove, install, repair or adjust springs or anything to which door spring parts are fastened, such as, wood blocks, steel brackets, cables or other like items. Installations, repairs and adjustments must be done by a trained door system technician using proper tools and instructions.

TABLE OF CONTENTS

SECTION	PAGE
SAFETY INFORMATION	2
OPENER FEATURES	3
SAFETY FEATURES	3
PRE-INSTALLATION CHECK LIST	4-5
RECOMMENDED TOOLS	6
PARTS IDENTIFICATION	6-7
KEY ILLUSTRATIONS	8
SAFETY INSTALLATION INFORMATION	9
INSTALLATION	
1 OPENER ASSEMBLY	9-11
2 INSTALLATION	12-14
3 WALL BUTTON INSTALLATION	15-16
4 SAFE-T-BEAM® SYSTEM INSTALLATION	17-18
5 CONNECTING TO POWER	19
ADJUSTMENTS	
6 LIMIT SWITCHES & FORCE ADJUSTMENT	20-22
KEYED EMERGENCY RELEASE	21
CONTACT REVERSE TEST	22
7 PROGRAMMING REMOTE CONTROLS	23
8 BATTERY/VISOR CLIP INSTALLATION	24
9 LIGHT BULB AND LENS INSTALLATION	24
SAFETY INSTRUCTIONS	25
MAINTENANCE & TROUBLESHOOTING	
10 ROUTINE MONTHLY MAINTENANCE	25
WIRING DIAGRAM	26
TROUBLESHOOTING GUIDE - OPENER	27
TROUBLESHOOTING GUIDE - POWER HEAD LED	28
TRANSMITTER COMPLIANCE STATEMENT	29
WARRANTY	30

OPENER FEATURES

INTELLICODE® Rolling Code Security System.

An electronic rolling code system that enhances the security of the door opener by continuously changing the access code each time the remote control is used. The door opener responds to each new code only once. An access code copied from a working system and tried again will not control the door opener.

Lighted Wall Console*

Operates door opener from inside garage.
(Refer to section 3)



and Car2U® compatible.

Follow the Homelink® or Car2U® instructions in your car owner's manual.

SAFETY FEATURES

Safe-T-Beam® Non-Contact Reversing System**.

Puts an invisible beam across the door opening. The door stops and reverses to the full open position if anything passes through the beam. Red or green LED indicator lights on the power head provide a self diagnostic code if an operational problem exists. (Refer to Section 10.)

Safe-T-Reverse® Contact Reversing System.

Automatically stops and reverses a closing door within 2 seconds of contact with an object. (Refer to Section 6.)

Safe-T-Stop® Timed Reversed System.

Automatically opens a closing door if it fails to close completely within 30 seconds.

Watch Dog™ Monitoring System.

Monitors the Safe-T-Beam® system to ensure proper functionality and will automatically stop and reverse a closing door if a problem is detected.

Automatic Lighting System.

One bulb lighting supplies up to 75 watts of light for safer evening exits and entries. Turns ON when door is activated and automatically turns OFF 3 minutes later.

Manual Emergency Release.

Manually releases door from door opener. Use during a power failure or other emergency to allow manual opening and closing of door. (Refer to Section 6.)

*Opener **MUST** be installed with the included Wall Console.

Safe-T-Beam® Safety Reverse System **MUST be installed to close door.

Things to consider if you are planning to "Do-it-yourself."

This opener is designed for use with **SECTIONAL** doors only.

In many cases you will be replacing an existing door opener with a new one, however, if this will be the first opener installed there are some pre-installation issues which need to be addressed. They are as follows:

The Genie Company recommends that you read and fully understand all information and instructions contained herein before choosing a "Do-it-yourself" installation. Any questions should be directed to The Genie Company or an authorized Genie® Dealer.

(The issue numbers below refer to the circled numbers in the illustrations on page 5.)

- 1** Check your ceiling where the power head of your new unit will be mounted. Plan how you will be mounting the power head. It is possible that ceiling joists may not be in the position needed with respect to the garage door opener. It may be necessary to add an additional bracket and fasteners (not included with your new door opener kit). (Refer to Section 2.)

- 2** Check the wall directly above the garage door. The door opener's header bracket must be securely fastened to this wall. Insure that the structure will provide a strong mounting location. (Refer to Section 2.)

- 3** Check to see if the mounting location for the Safe-T-Beam® System is clear from obstruction and has a wood surface available for attaching the mounting brackets. The brackets may be attached to concrete if necessary but extra tools and special fasteners (not supplied) will be required. (Refer to Section 4 and 5.)

NOTE: Mounting brackets must be installed within code specifications.

- 4** Is your sectional garage door made of aluminum, light-weight steel, fiberglass or glass panels? Additional support bracing must be added to these type doors. If this is the case, please contact the door manufacturer or authorized dealer so that they can furnish you with a "bracing kit." (Refer to Section 2.)

WARNING

To reduce the risk of injury to persons or damage to property - Use this opener only with sectional doors.

- 5** You need a properly grounded 110-120 Volt power supply available. The outlet should be no more than 3 feet from the power head once it is mounted. (Refer to Section 5.)

WARNING

**DO NOT USE AN EXTENSION CORD!
DO NOT USE A PORTABLE GENERATOR!** This product is designed to operate on standard house current.
DO NOT USE ALTERNATE POWER SUPPLIES.

- 6** To avoid damage to your door and/or opener, make sure you disable and/or remove any door locks, ropes, and/or cables (NOT door lift cables) prior to installing your opener. (Refer to Section 1.)

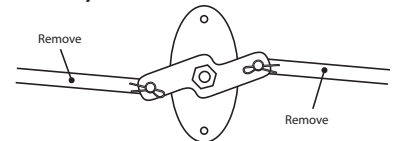

- 7** Insure that your door is properly balanced and moving freely. (Refer to Section 10.)

WARNING

If your door jams, binds, is improperly balanced or has a broken spring, have it repaired or adjusted by a trained door system technician. Door springs, cables, pulleys, brackets and associated hardware are under extreme tension and can cause serious injury or death.

- 8** (NOT SHOWN) If your garage does not have a separate entry door, you should consider an emergency release kit (GER-2) for installation on your garage door.

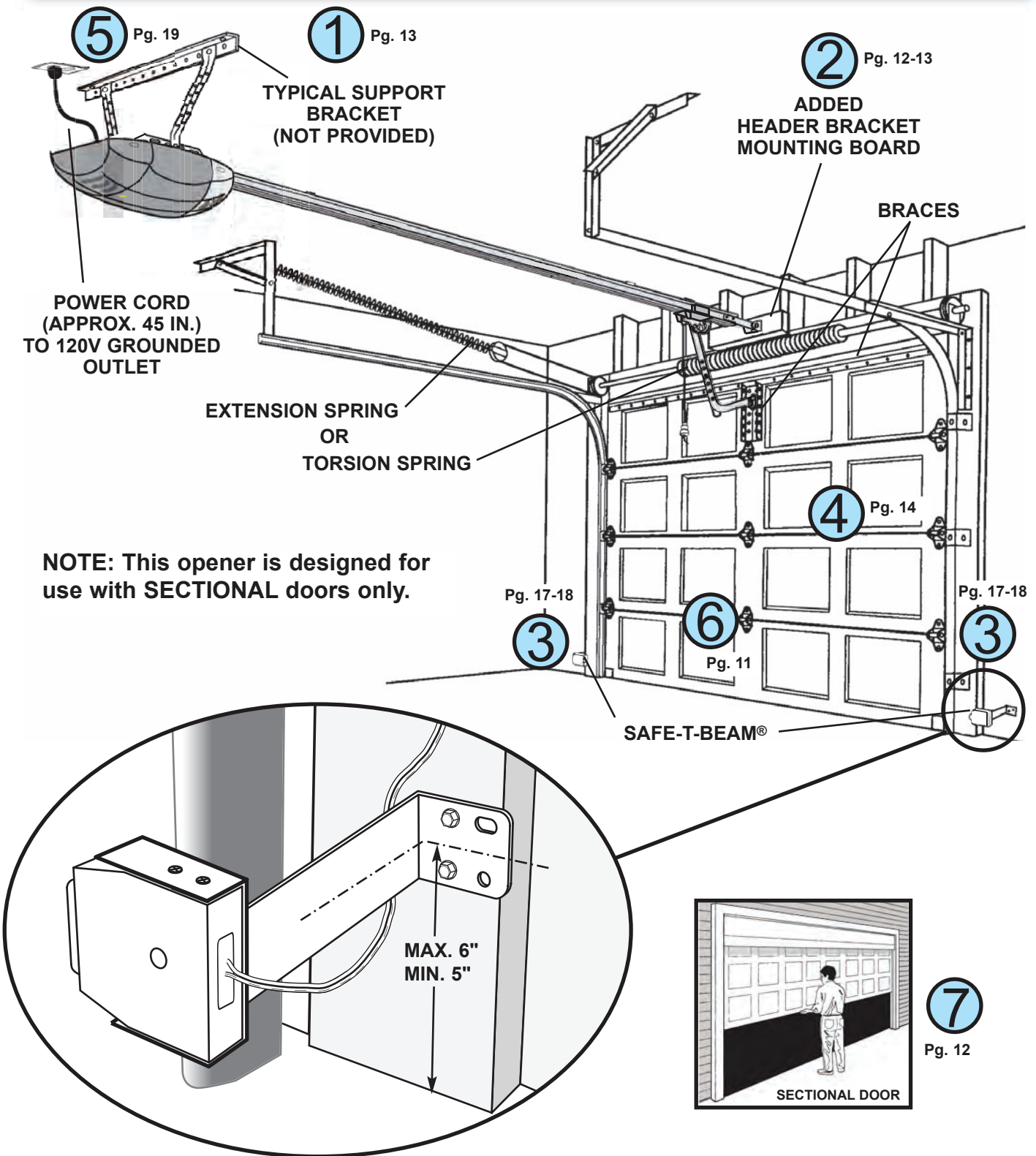

NOTE: This opener is designed for use with **SECTIONAL** doors only.

⚠ WARNING
 To reduce the risk of injury to persons or damage to property - Use this opener only with sectional doors.

RECOMMENDED TOOLS

FOR HELP-1.800.354.3643 OR WWW.GENIECOMPANY.COM

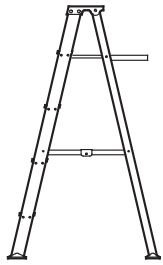

Step ladder

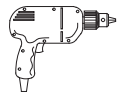

Drill



Safety Glasses



3/16" Drill Bit



Ratchet



Phillips screwdriver



Pencil

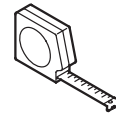

Tape measure



Adjustable wrench

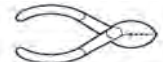

Wire strippers

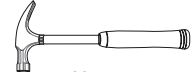

Hammer



1/4", 7/16", 3/8" and 1/2" Sockets



Carpenter's level

PARTS IDENTIFICATION - Not Shown Full Size .



Safety Brochures

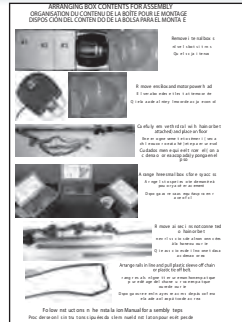

Box Contents Sheet



Entrapment Warning Label

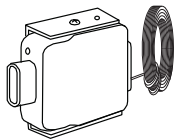

Safe-T-Beam® Source with wire (Red LED)

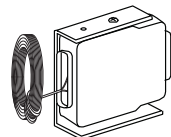

Safe-T-Beam® Sensor with wire (Green LED)



Wire



Header Bracket



Door Bracket

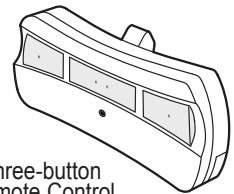

Three-button Remote Control



Insulated Staple

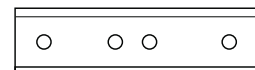

Rail Section Clamp

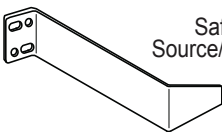

Safe-T-Beam® Source/Sensor Bracket

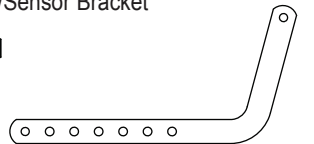

Door Arm



Wall Control (varies with model)

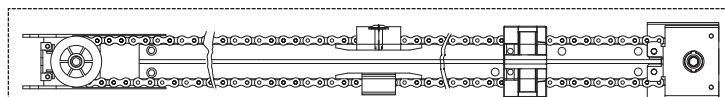

Pro Rail (Chain) Section

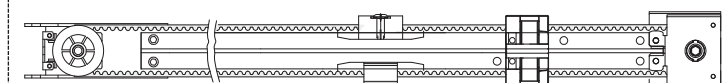

Pro Rail (Belt) Section

OR

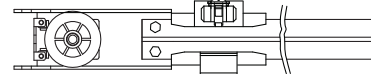

End Rail Section

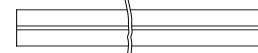

Center Rail Section

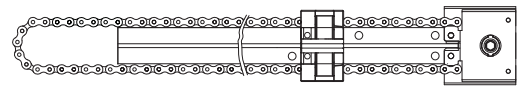

Head Rail (Chain) Section

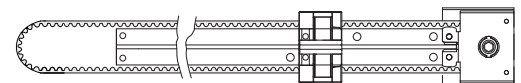

Head Rail (Belt) Section

FASTENERS - Shown Full size (See Parts List below for full description.)

BAG NO.	DESCRIPTION	QUANTITY
0	RAIL SECTION CLAMP	2
	RAIL CLAMP BOLT – 5/16 -18 x 5/8"	8
	HEX FLANGE NUT – 5/16 -18	8
1	BOLT – 5/16 -18 x 1/2"	3
2	CLEVIS PIN, LONG – 5/16" x 3"	1
	COTTER PIN	1
	HEADER BRACKET	1
	LAG SCREW – 5/16" x 2"	2
3	HEX BOLT – 5/16 -18 x 3/4"	5
	HEX FLANGE NUT – 5/16 -18	5
	LAG SCREW – 5/16" x 2"	2
4	SELF DRILLING SCREW – 1/4 -20 x 3/4"	3
	DOOR BRACKET	1
5	HEX BOLT – 5/16 -18 x 3/4"	3
	SELF LOCKING NUT – 5/16 -18	1
	HEX FLANGE NUT – 5/16 -18	2
	CLEVIS PIN – 5/16" x 3/4"	1
	COTTER PIN	1
6	WALL CONTROL ASSEMBLY	1
	PAN HEAD PHILLIPS SCREW – #4-24 x 1"	2
7	13 MM INSULATED STAPLE	30
8	Safe-T-Beam® SOURCE/SENSOR BRACKET	2
	PHILLIPS HEX SCREW – #10-16 x 1- 1/4"	4
	WIRE NUT (GREY)	4
NO NUMBER	REMOTE WITH BATTERY	1
NO BAG	Safe-T-Beam® SOURCE/SENSOR & WIRE SET	1
NO NUMBER	LIGHT COVER - WHITE	2

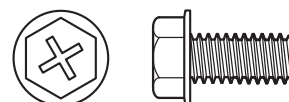

Rail Clamp Bolt - 5/16 -18 x 5/8"



#10-16 x 1-1/4" Phillips Hex Screw



#4-24 x 1" Pan Head Phillips Screw

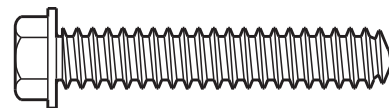

Lag screw - 5/16" x 2"



Wire Nut



Self Locking Nut
5/16 -18

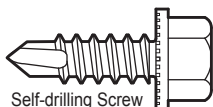

Self-drilling Screw
1/4 -20 x 3/4"

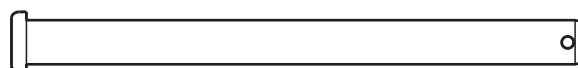

Clevis pin, long 5/16" x 3"

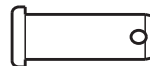

Clevis pin
5/16" x 3/4"



Cotter pin



Hex Flange Nut
5/16 -18

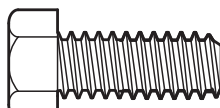

Hex Bolt - 5/16 -18 x 3/4"

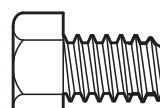

Hex Bolt - 5/16 -18 x 1/2"

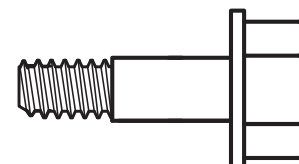

Shoulder Bolt
5/16 -18 x 1"



Hex Flange Nut
1/4 -20

MISSING ANY PARTS? Please call toll free - 1.800.354.3643
DO NOT RETURN TO POINT OF PURCHASE.
IMPORTANT! - Information needed when calling
 • Model number - (located on packaging)
 • Store, city, state, and date of purchase

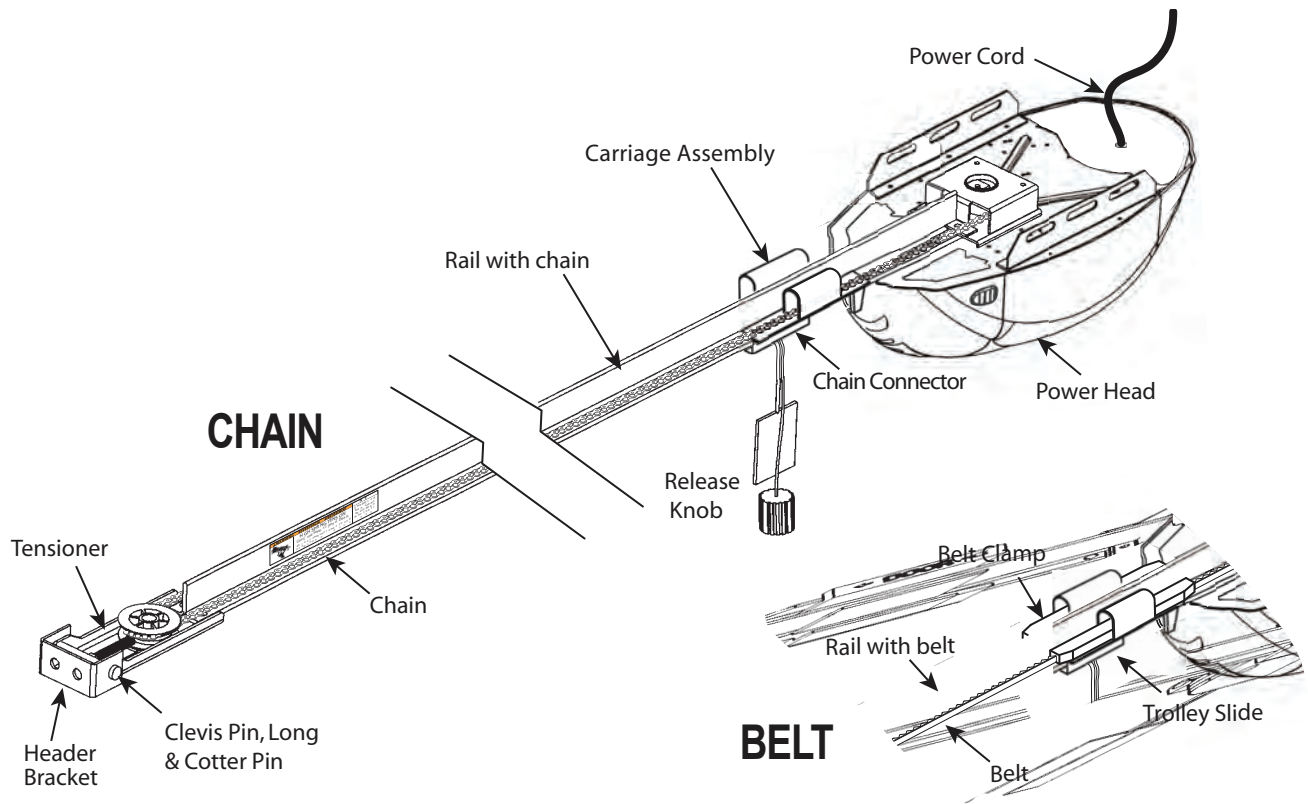

3-PIECE RAIL HARDWARE ASSEMBLED VIEW

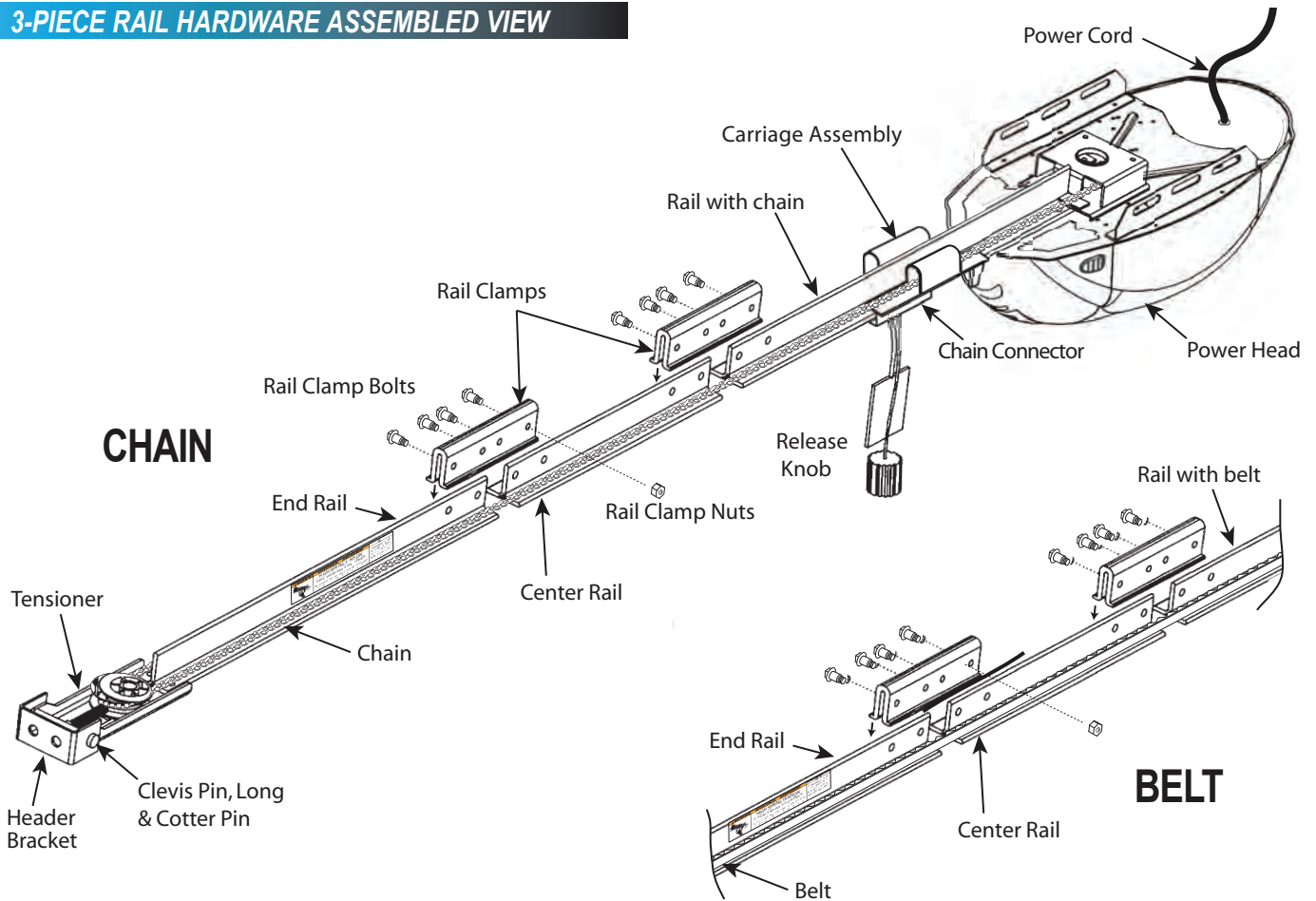

IMPORTANT INSTALLATION INSTRUCTIONS

⚠ WARNING: To reduce the risk of severe injury or death:

1. **READ AND FOLLOW ALL SAFETY, INSTALLATION AND OPERATION INSTRUCTIONS.** (If you have questions or do not understand an instruction, call the Overhead Door Corporation.)
2. Install only on a properly balanced **sectional** or **one piece** garage door. An improperly balanced door could cause severe injury. Have a trained door system technician make repairs or adjustments to cables, spring assemblies, and other hardware **before** installing the opener.
3. Remove all ropes and remove or make inoperative all locks connected to the garage door before installing opener.
4. Where possible, install the door opener **7 feet or more above** the floor. For products having an emergency release, mount the emergency release within reach, but at least 6 feet above the floor to avoid contact with vehicles to prevent accidental release.
5. **Do NOT** connect the opener to source of power until instructed to do so.
6. Locate the wall console:
 - Within sight of the garage door,
 - At minimum height of 5 feet so small children are not able to reach it, and
 - Away from all moving parts of the door.
7. Install the **Entrapment WARNING Label** next to the wall console in a prominent location.
8. After installing the opener, the door must reverse within 2 seconds when it contacts a 1-1/2 inch high object (or a 2 x 4 board laid flat) on the floor.

1 OPENER ASSEMBLY

RAIL ASSEMBLY: Use a clean, flat surface.

NOTE: For 1-piece rail—skip to **POWER HEAD & RAIL ASSEMBLY**.

⚠ WARNING

To reduce the risk of injury to persons or damage to property - Use this opener only with sectional doors.

⚠ CAUTION

Do NOT run until opener is fully assembled and instructed to do so.

NOTE: Three (3) piece rail assemblies are for a 7 foot high door.

Clear a workspace area to unpack and organize box and contents for assembly.

1. There are 4 boxes inside the carton. Each box is numbered 1 - 4. *Note that some openers will contain the same parts and be packaged with fewer boxes.* **Carefully remove the three internal boxes (Labeled #1, 2, and 3) and place them on the floor for easy access (Fig. 1-1).** These boxes contain assembly parts and the contents are organized by assembly tasks. For quick reference inside the lid of each box there is a label illustrating the components inside.
2. **Remove the motor power head and place it on the floor for later use. Remove box #4 and place it on the floor for later use.**

FOR HELP-1.800.354.3643 OR WWW.GENIECOMPANY.COM

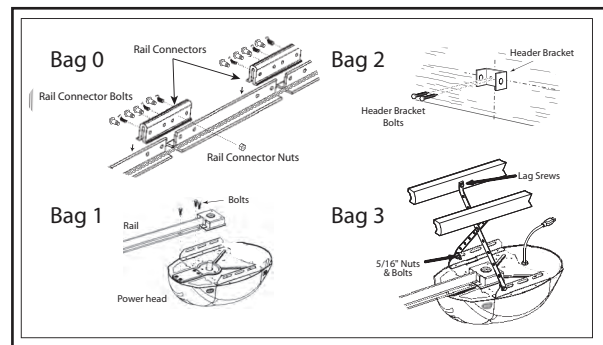

Box Label Example

FIG. 1-1 Internal boxes.

Rail Assembly for CHAIN DRIVE OPENER

NOTE: For split rail clamps, nuts, and bolts locate Bag 0 from Box 1.

3. Remove the two rail sections that are not connected to the chain and place them on floor (Fig. 1-2, A).
4. Carefully remove the third rail section with chain and plastic sleeve. Place rail section on floor and extend chain straight out (Fig. 1-2, B). Chain and rail should extend approximately 7 feet.
5. Remove wire ties and plastic bag from chain. Leave chain extended straight out on floor. Avoid kinks in the chain by careful handling and keeping chain flat on the floor.
6. Align the three rail sections by pulling the chain straight and wrapping it around the chain tensioner pulley (Fig. 1-3 & 1-4).
7. Attach the two rail clamps to the rail section joints with (4) bolts and nuts. After both rail clamps have been assembled to the rail sections, securely tighten the bolts and nuts.

CHAIN DRIVE RAILS

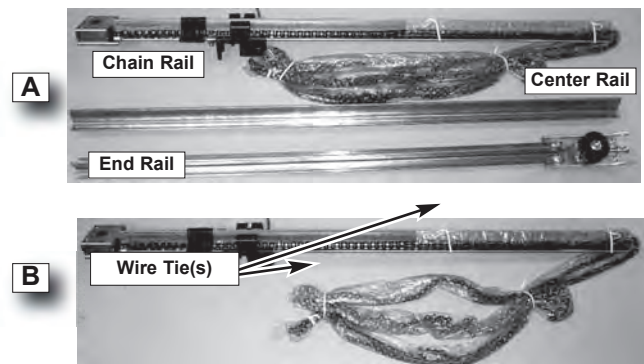

BELT DRIVE RAILS

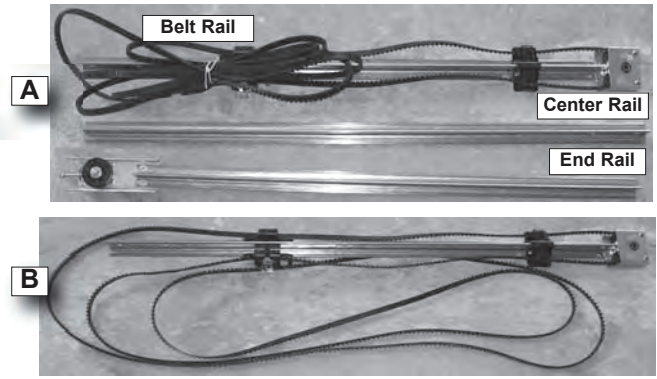

FIG. 1-2 Split Rail sections.

Rail Assembly for BELT DRIVE OPENER

NOTE: For split rail clamps, nuts, and bolts locate Bag 0 from Box 1.

3. Remove the two rail sections that are not connected to the belt and place them on floor (Fig. 1-2, A).
4. Carefully remove the third rail section with belt. Place rail section on floor, remove ties on belt and extend belt straight out (Fig. 1-2, B). Avoid twists and kinks in the belt by careful handling and keeping belt flat on the floor. Belt and rail should extend approximately 7 feet.
5. Align the three rail sections by pulling the belt straight and wrapping it around the tensioner pulley (Fig. 1-3 & 1-4).
6. Attach the two rail clamps to the rail section joints with (4) bolts and nuts. After both rail clamps have been assembled to the rail sections, securely tighten the bolts and nuts.

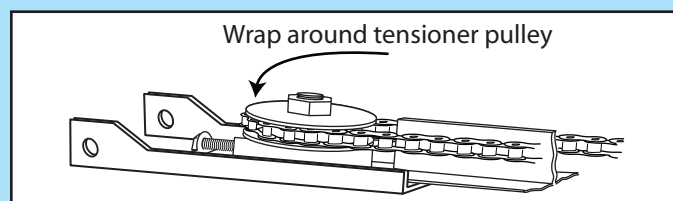
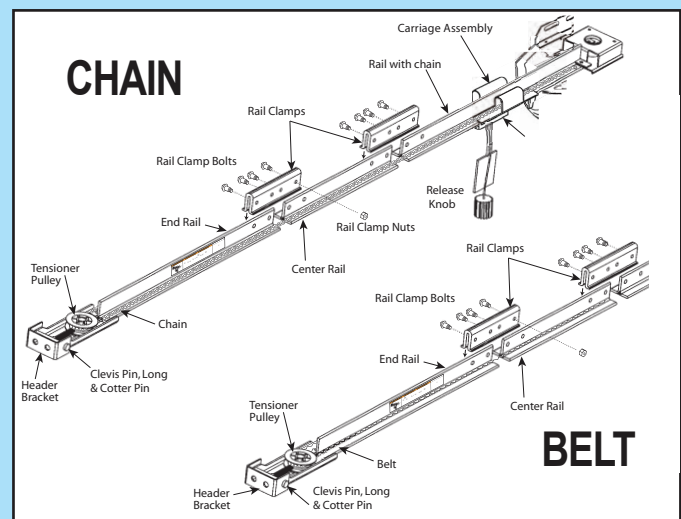

FIG. 1-4 Mount chain/belt to tensioner pulley.

POWER HEAD & RAIL ASSEMBLY

Assembly for CHAIN DRIVE OPENER

NOTE: Handle carefully! Drive chain can slide out of rail.

NOTE: For power head and rail assembly locate Bag 1 from Box 1.

NOTE: Copy serial number from power head frame and record it on warranty page.

1. Attach rail assembly to power head by aligning the sprocket onto the motor shaft. Use (3) bolts, 5/16" -18 x 1/2" (Fig. 1-5).
2. Tighten the chain by turning the adjustment nut clockwise. The chain adjustment nut is located in the Chain Pulley Bracket (opposite rail end from the power head) (Fig. 1-6).
3. Tighten chain until chain is approximately 1/8 inch above the base of the rail at midpoint on the rail (Fig. 1-6). Do NOT over tighten chain.

CAUTION

You should have removed all ropes and/or cables (NOT door lift cables) and disabled the door lock already. If you have not, remove all ropes and/or cables and disable garage door lock **NOW** before continuing with installation (Fig. 1-8).

Set assembled power head and rail aside. Begin with Section 2 INSTALLATION.

Assembly for BELT DRIVE OPENER

NOTE: For power head and rail assembly locate Bag 1 from Box 1.

NOTE: Copy serial number from power head frame and record it on warranty page.

1. Attach rail assembly to power head by aligning the sprocket onto the motor shaft. Use (3) bolts, 5/16" -18 x 1/2" (Fig. 1-5).
2. Tighten the belt by turning the adjustment nut clockwise. The belt adjustment nut is located in the Belt Pulley Bracket (opposite rail end from the power head) (Fig. 1-7).
3. Tighten belt until belt is approximately 1/8 inch above the base of the rail at midpoint on the rail (Fig. 1-7). Do NOT over tighten belt.

CAUTION

You should have removed all ropes and/or cables (NOT door lift cables) and disabled the door lock already. If you have not, remove all ropes and/or cables and disable garage door lock **NOW** before continuing with installation (Fig. 1-8).

Set assembled power head and rail aside. Begin with Section 2 INSTALLATION.

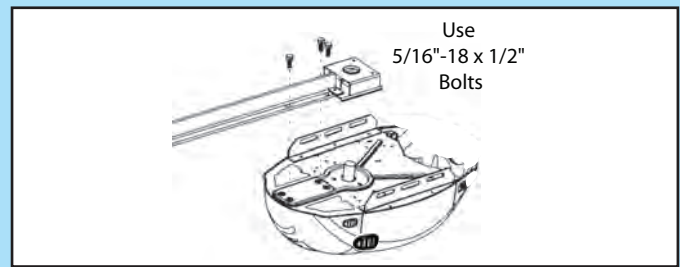

FIG. 1-5 Rail - Power head assembly.

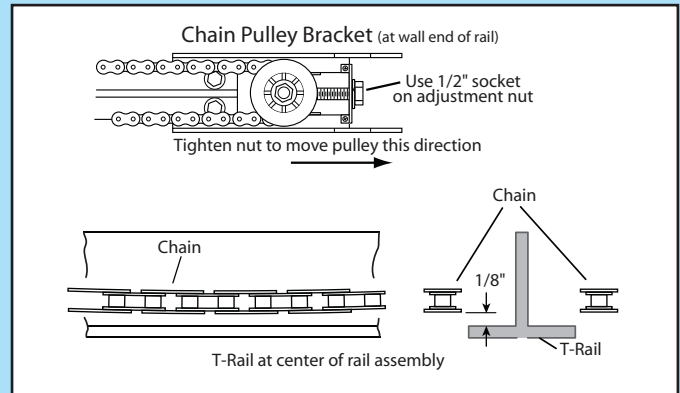

FIG. 1-6 Chain adjustment.

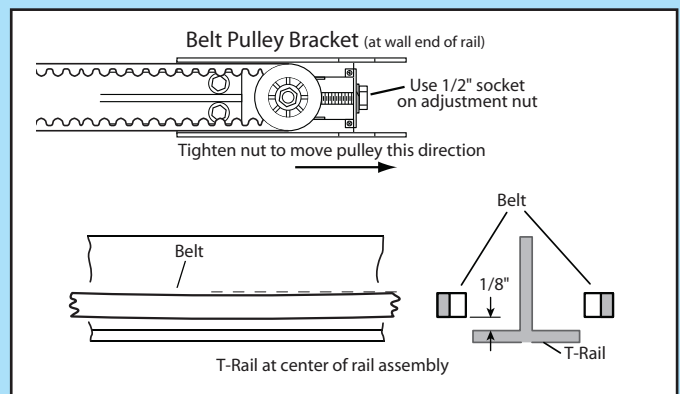

FIG. 1-7 Belt adjustment.

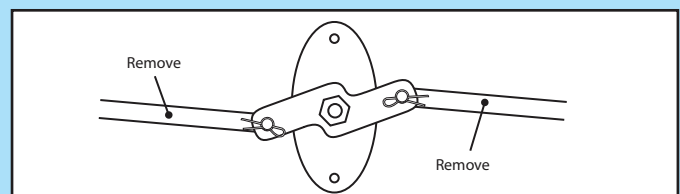

FIG. 1-8 Disable garage door lock.

2 OPENER INSTALLATION

FOR HELP-1.800.354.3643 OR WWW.GENIECOMPANY.COM

HEADER AND DOOR MOUNTING BRACKETS:

⚠ WARNING

Header bracket must be fastened to garage framing. **Do NOT** fasten to drywall, particle board, plaster or other such materials.

1. Finding header bracket mounting location.

- Close garage door.
 - Use a pencil and level.
 - a) Mark center of garage door (*one-half overall width*) on the wall with 6" vertical line at top edge of door.
 - b) Continue this line on wall above door for about 12" (**Fig. 2-1, a**).
- Raise garage door until **top edge** of door reaches its maximum height (**Fig. 2-2**).
- With door at highest point.
 - Measure height from top edge of door to floor (**Fig. 2-2**).
- Close door again.
- Mark height measurement on wall above door (**Fig. 2-1, c**).
 - Make your mark across vertical line made earlier.
- Add 2-1/2" to height mark just made on wall. This is location for header bracket (**Fig. 2-1, d**).

⚠ WARNING

Door springs are under high tension. If spring or its shaft is in the way, measure 2-1/2" above spring or shaft on the garage door centerline and mark this height as your location for header bracket.

Do NOT move door spring!

NOTE: If header bracket location needs to be above header for garage door opening, you need to add a "mounting surface." A 2" x 6" board securely attached (board and fasteners not included) to wall studs on either side of your mark is sufficient (**Fig. 2-3**).

NOTE: For header bracket and bolts locate Bag 2 from Box 1.

NOTE: The bolts supplied in Bag 2 are designed to be used on pressure treated lumber.

2. Mounting the header bracket.

- Hold header bracket against wall (**Fig. 2-3**).
- Position bracket as shown.
 - Place center on vertical line,
 - Bottom edge on final height line.
- Mark screw hole locations on wall.
- Drill 3/16" pilot holes at each screw hole mark.
 - Fasten header bracket with 2 lag screws (provided) (**Fig. 2-3**).

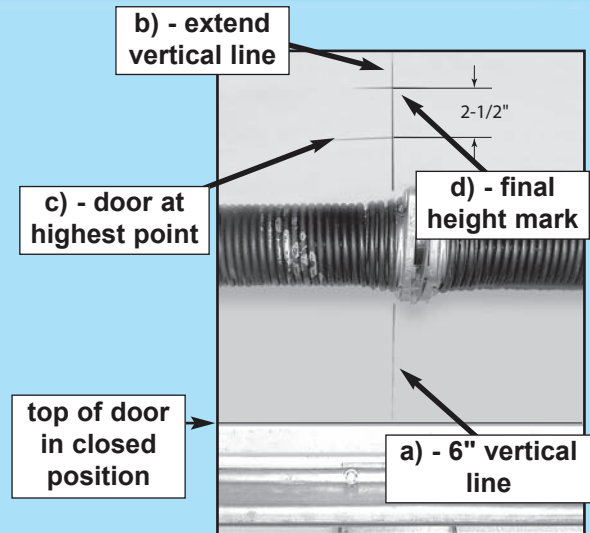

FIG. 2-1 Final height mark.

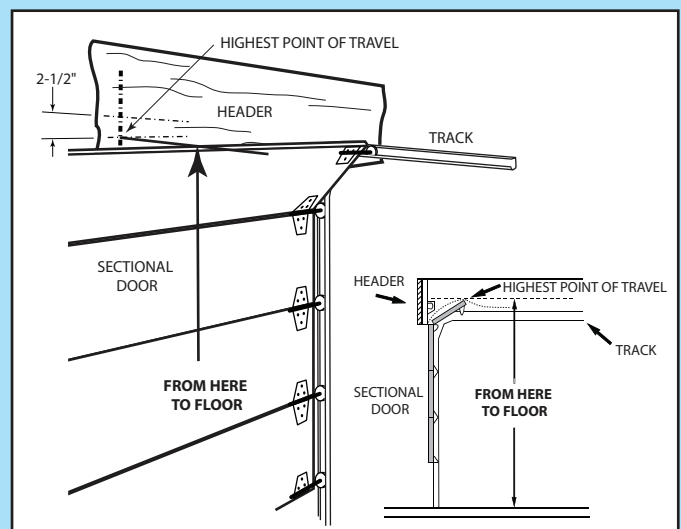

FIG. 2-2 Finding highest point of travel.

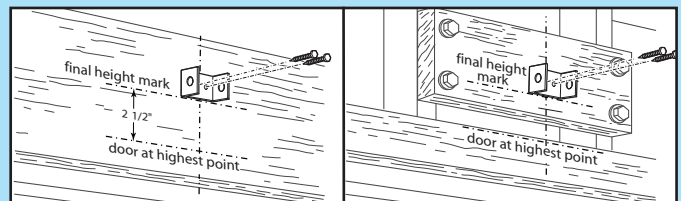

FIG. 2-3 Header bracket mounting (on header & above header).

MOUNTING THE OPENER:

1. Getting started.

- Position assembled rail on wall next to header bracket (**Fig. 2-4**).
 - Place material on floor under power head to protect from scratching. (A box, stool, or similar device may be needed to clear a torsion spring.)

NOTE: For header bracket pins locate Bag 2 from Box 1.

2. Mounting the assembly.

- Attach rail to header bracket using clevis pin and cotter pin (**Fig. 2-5**).
- Support power head on step-ladder to prevent interference with header mounted (torsion) spring.

NOTE: Before final attachment to ceiling, insure that assembly is in proper alignment (**Fig. 2-4**).

NOTE: For nuts, bolts, and lag screws locate Bag 3 from Box 1.

- On **finished** ceilings, locate ceiling joists or trusses using a stud finder or similar device. Attach angle iron (not provided) to joists or trusses through finish material using (provided) lag screws (**Fig. 2-6**).
- On **unfinished** ceilings or open ceilings, straps may attach directly to joists or trusses. Depending on the garage construction, extra framing material (not provided) which may be required should be installed using appropriate construction techniques (**Fig. 2-6**).

NOTE: Refer to your local building codes for appropriate construction techniques.

- Attach mounting straps (not provided) to ceiling using lag bolts (**Fig. 2-6**).
- Set height of power head to following (**Fig. 2-6**).
 - a) Rail must clear door at door's highest point of travel.
 - b) Rail must be level or at power head end slightly below level.
- Securely tighten power head mounting bolts and nuts.
- Carefully raise and lower door manually. Ensure door does not contact any section of power head or rail.
- Check that rail clamp bolts and nuts are tight.
- **DO NOT PLUG OPENER IN YET!**

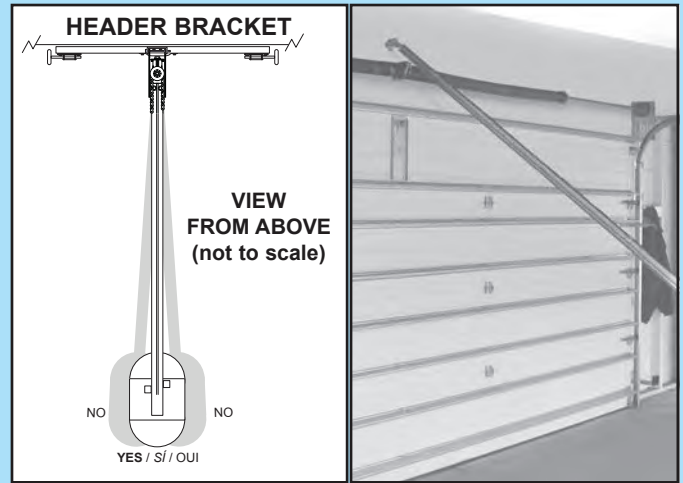

FIG. 2-4 Position assembly and align.

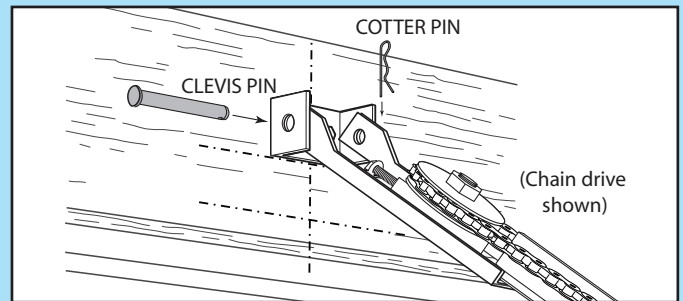
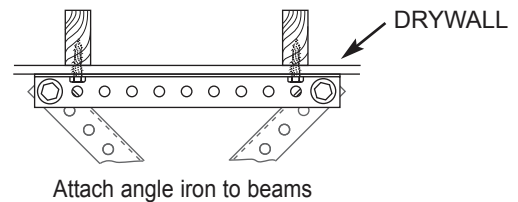

FIG. 2-5 Rail mounting to header bracket.

ANGLE IRON ON FINISHED CEILING



UNFINISHED OR OPEN BEAM

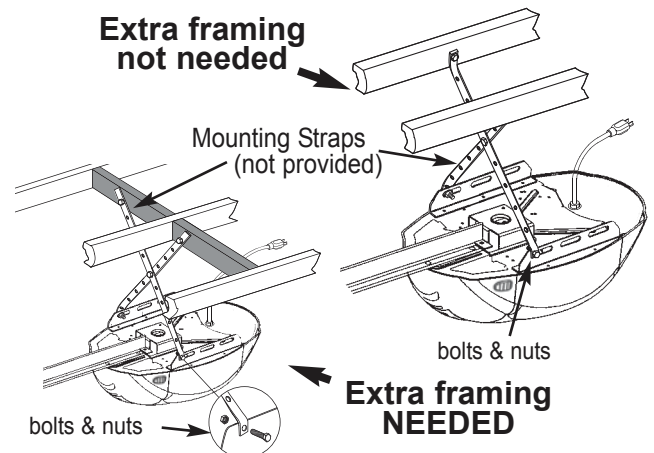

FIG. 2-6 Mounting the power head

DOOR BRACKET:

CAUTION

Doors made of masonite, lightweight wood, fiberglass, and sheet metal must be properly braced before mounting door opener. Contact door manufacturer or distributor for a bracing kit. The Genie Company is not responsible for damage caused due to improperly braced door.

NOTE: For door bracket and bolts locate Bag 4 from Box 2.

1. Finding door bracket mounting location.

- Door bracket is mounted as high on door as possible along vertical centerline and **NO LOWER THAN** top set of rollers (Fig. 2-7).

2. Mounting the door bracket.

- Proper bracing should be verified at this point.
 - Align door bracket centered on your vertical centerline (Fig. 2-8).
 - Attach using **3 self-drilling screws** for sheet metal or other **light weight material**.
 - Use **lag screws** (not provided) for **solid wooden sectional doors**.

NOTE: For solid wood doors, carriage bolts WITHOUT SLOTTED HEADS (not included) may also be used for attaching door bracket.

INSTALL DOOR ARMS

NOTE: For door arm nuts and bolts, clevis and cotter pins locate Bag 5 from Box 2.

1. Attach the arms.

- Fasten short branch of curved door arm to door bracket using bolt and locking nut (Fig. 2-9).
- Fasten straight arm to carriage using clevis pin and cotter pin (Fig. 2-9).

2. Connecting the arms.

- Slide carriage back and forth to adjust arm length.
 - Position the straight arm **50°** down from the rail.
- With the arms arranged in this position, fasten arms together using bolts and nuts spaced as far apart as possible (Fig. 2-9).

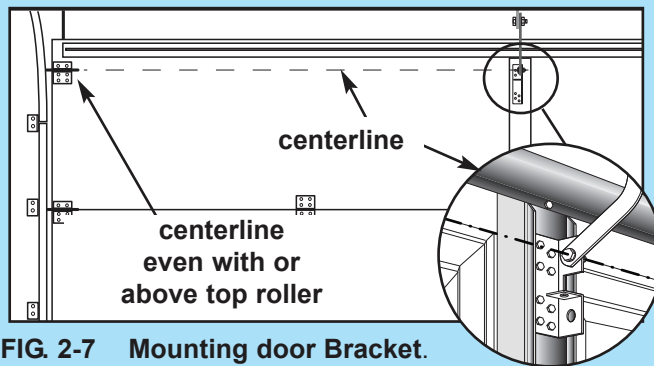

FIG. 2-7 Mounting door Bracket.

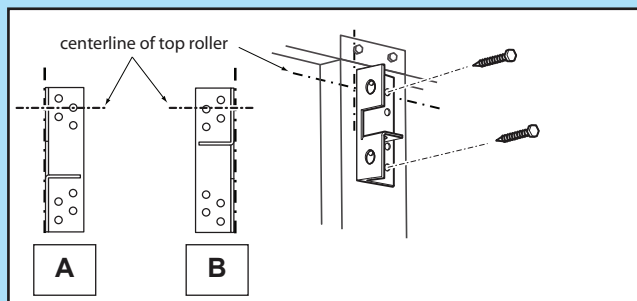

FIG. 2-8 Examples of door bracket positioning.

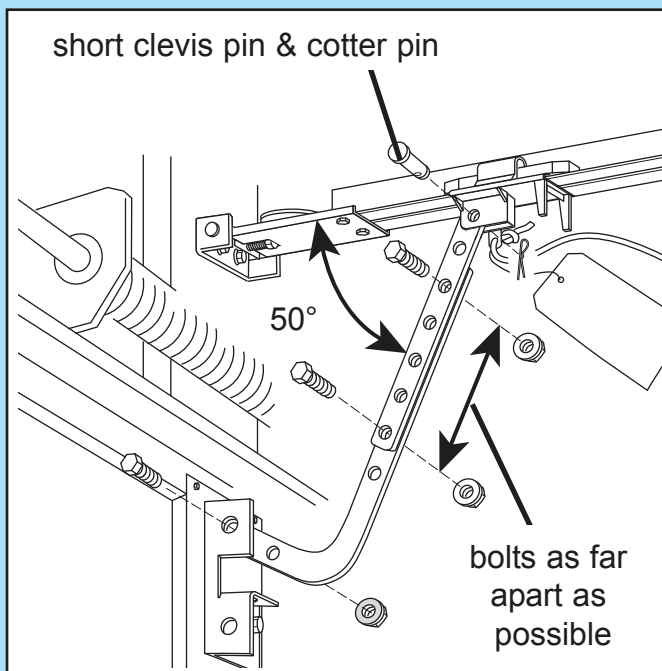

FIG. 2-9 Attaching door arms.

3 WALL CONSOLE INSTALLATION

FOR HELP-1.800.354.3643 OR WWW.GENIECOMPANY.COM

⚠ WARNING

Verify there is **NO** power to the opener before installing Wall Console wires and Wall Console.

⚠ CAUTION

Staples which are too tight can cut or pinch wires. Cut or pinched wires can cause the Wall Console to stop working. When using the insulated staples, make sure you fasten them only as tightly as needed to hold the wire snugly.

⚠ WARNING

Use of any other wall control can cause the door to operate unexpectedly and the light not to work. Use only the included Wall Console.

NOTE: Wall console will not operate until limits are set.

NOTE: For Wall Console, wire and insulated staples locate Bags 6 and 7 from Box 2.

1. Wall Console location.

- Wall Console location should be in direct sight of door.
- It should be at least five feet (5') above floor to prevent small children from operating door.
- It must be away from any moving parts. (You should NOT be able to reach the garage door while standing at Wall Console.)
- Wall Console board screw connections are polarized, (+) positive and (-) negative.

2a. Wiring (If pre-wired).

- Locate Wall Console pre-wired wire ends (**Fig. 3-1**). (They should be located within the guidelines mentioned above.)
- Split and strip ends of wire (**Fig. 3-2**).
- Fasten wire to Wall Console board screws on back of Wall Console.
 - Striped wire to the + (plus) terminal.
 - White wire to the - (minus) terminal.

2b. Wiring (If NOT pre-wired).

- Pick a convenient location for mounting Wall Console using the guidelines mentioned above (**Fig. 3-1**).
- Run wire from power head to Wall Console (**Fig. 3-1**).
- Split and strip ends of wire (**Fig. 3-2**).
- Fasten wire to Wall Console board screws on back of Wall Console.
 - Striped wire to the + (plus) terminal.
 - White wire to the - (minus) terminal.

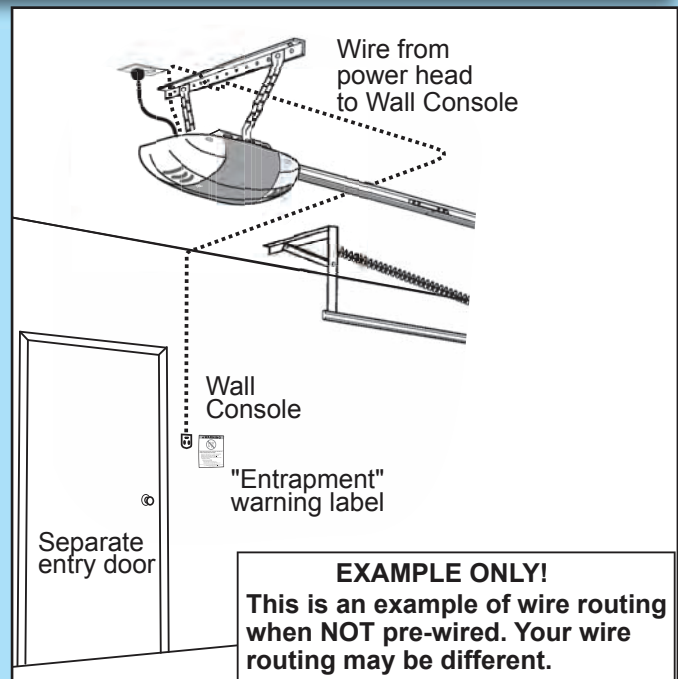

FIG. 3-1 Wall Console wire routing

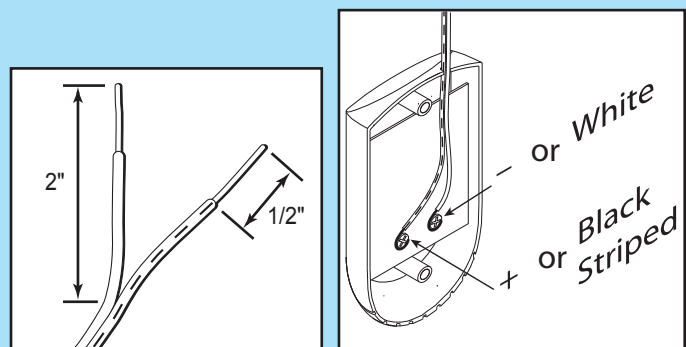
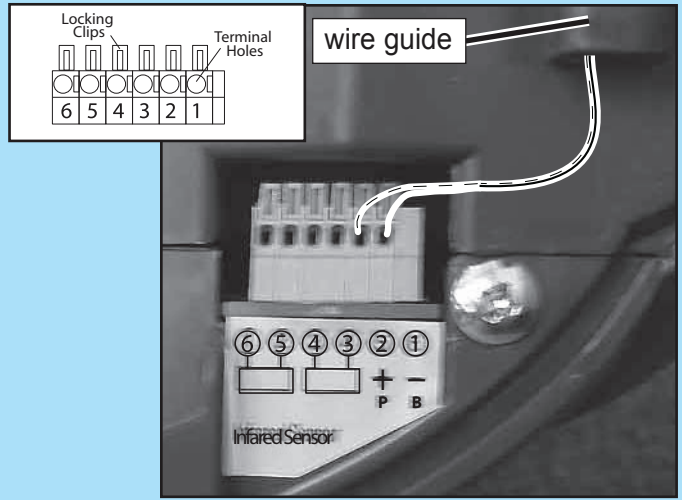

FIG. 3-2 Splitting and stripping.

3. Securely fasten wires.

- Securely fasten wires to ceiling and wall using insulated staples provided.
 - Use insulated staples.
 - Staples should be snug only.
- If rear cover is attached to power head, remove it.
- On power head:
 - Route Wall Console wires through wire guide on power head.
 - Split and strip ends of wire (**Fig. 3-2 on previous page**).
 - Insert wire into terminal holes and lightly press in the orange locking clips above each terminal hole. (You can use a pencil or small screwdriver to comfortably press in locking clips.) The white wire into #1 terminal hole and striped wire into the #2 terminal hole.
 - Confirm wire lock by lightly tugging on the wire. The wire should remain in the terminal hole.
- Do NOT install rear cover yet.**



(Power Head With Rear Cover Removed)

FIG. 3-3 Insert wires.

4. Mounting.

- Fasten Wall Console to wall with 2 screws (provided) (**Fig. 3-4**).
- Remove protective backing from "Entrapment" warning label (**Fig. 3-5**). The "Entrapment" label is located in the center of this manual.
- Stick label on wall near Wall Console.
 - Stick label on wall near Wall Console.

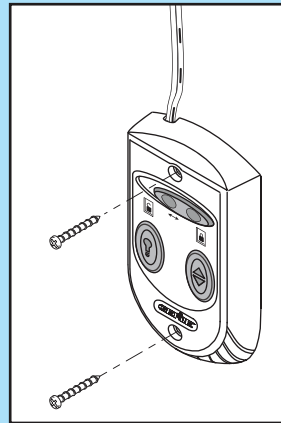

FIG. 3-4 Mounting Wall Console.

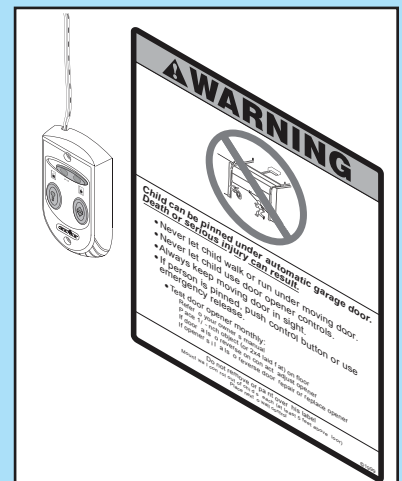
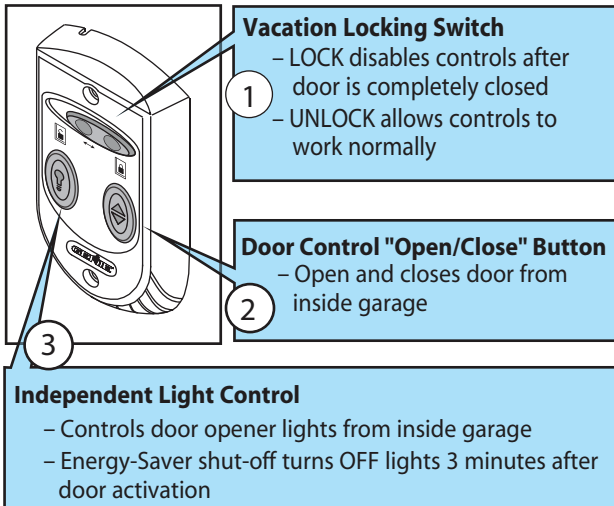

FIG. 3-5 Mounting Entrapment warning label.

⚠ WARNING

There should be no electrical power to the opener while installing Safe-T-Beam® wires. If you have plugged in the power cord—**UNPLUG IT NOW!**

NOTE: The opener will not close the door automatically unless the Safe-T-Beam® System is installed.

NOTE: For Safe-T-Beam®, screws, wire, and insulated staples locate items and Bag 8 from Box 3.

1. Mounting brackets.

- Mark both sides of garage door frame or wall no higher than 6" and no lower than 5" above floor (Fig. 4-1).
- Hold bracket against door frame or wall.
 - Check if brackets extend out from wall far enough, so tongue of bracket is beyond door, tracks or any door hardware.
 - If not:
 - a) Mounting bracket extensions are available through an authorized Genie® Dealer.
 - b) Blocks of wood, etc. may be substituted for extensions.
- Center bracket on your mark (Fig. 4-2).
- Fasten each with 2 screws (Fig. 4-2).

NOTE: Mounting brackets can be attached to the floor or concrete rim using concrete anchors (not provided).

2. Mounting Safe-T-Beam® Source (Red LED) and Sensor (Green LED).

- If garage has only one garage door.
 - Determine which side of garage receives most direct sunlight (Fig. 4-4).
 - Red LED should always be on sunny side whenever possible (Fig. 4-4).
- For multiple doors.
 - Preventing crossed signals is critical.
 - Place source and sensor modules on adjacent doors facing in opposite directions (Fig. 4-4).

NOTE: To help prevent interference from sun, Safe-T-Beam® sensor with Green LED may be placed further away from the door opening, though extended no further out from the wall, where it will spend more time in shadow.

- Slide source/sensor onto tongue of bracket until it clicks into place (Fig. 4-3).

3a. Wiring (If NOT pre-wired).

- Route wire from Safe-T-Beam® to power head using method shown in (Fig. 4-5a).
- Securely fasten wires to wall and ceiling as you go (Fig. 4-6 on next page).
 - Use insulated staples.
 - Staples should be snug only.

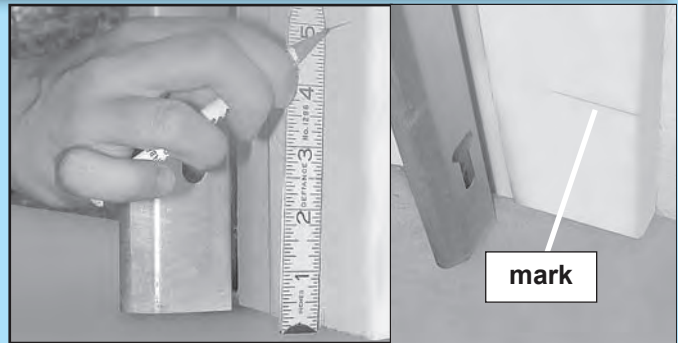

FIG. 4-1 Mark door frame.

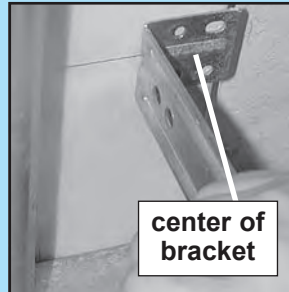

FIG. 4-2 Mounting brackets.

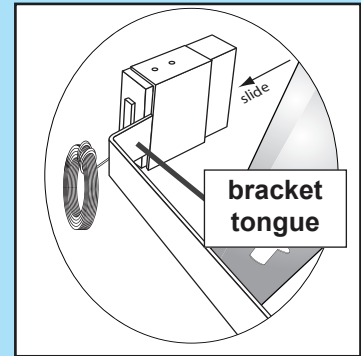

FIG. 4-3 Attach Safe-T-Beam® to brackets

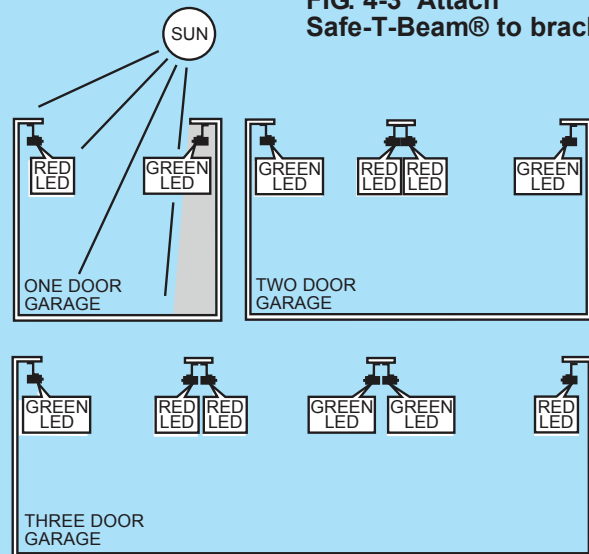

FIG. 4-4 Safe-T-Beam® source and sensor locations.

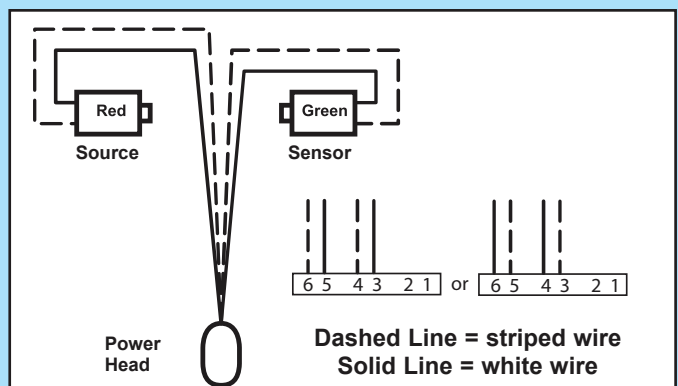

FIG. 4-5a Source and sensor wiring methods.

3b. Wiring (pre-wired).

- Route wire from wall to Safe-T-Beam® sensors (Fig. 4-5b).
- Splice pre-wiring to shortened sensor wire, match wire pairs *dash-to-dash (striped-to-striped)* and *plain-to-plain (white-to-white)*.
 - Trim sensor wire to approximately one foot (1 ft) from sensor.
 - Split and strip ends of sensor wires and pre-wired wires (Fig. 4-7).
 - Splice wires together with (provided) wire nuts.
- Route wire from ceiling to power head (Fig. 4-5b).
- Securely fasten wires where they exit wall and ceiling as you go.
 - Use insulated staples.
 - Staples should be snug only.

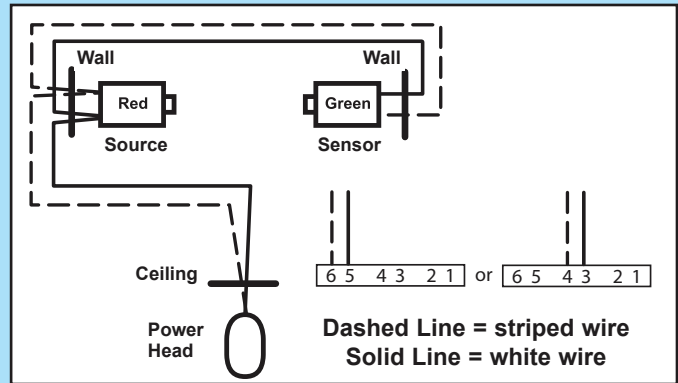

FIG. 4-5b Pre-Wired source and sensor wiring methods.

CAUTION

Staples which are too tight can cut or pinch wires. Cut or pinched wires can cause the Safe-T-Beam® System to stop working. When using the insulated staples, make sure you fasten them only as tightly as needed to hold the wire snugly.

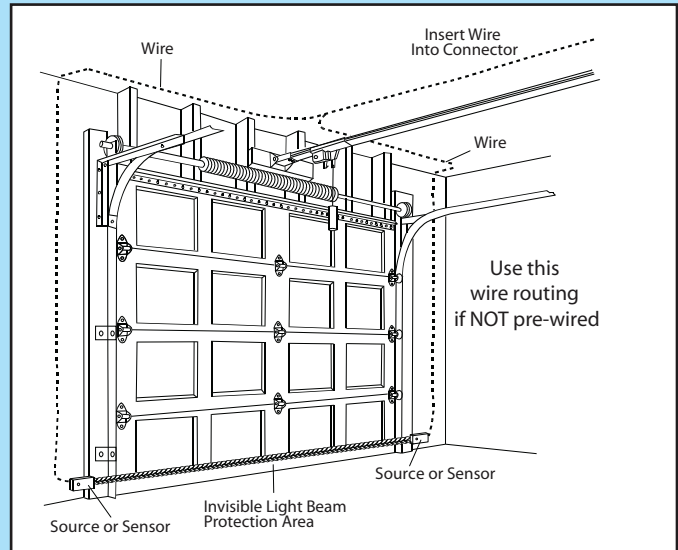

FIG. 4-6 Wire routing.

4. Split and strip ends of sensor wires (Fig. 4-7).

NOTE: For rear cover locate Box 4.

5. Attach Safe-T-Beam® wire to power head wire terminal.

- Route Safe-T-Beam® wires through wire guide on power head.
 - Insert wire into terminal holes and lightly press in the orange locking clips above each terminal hole. (You can use a pencil or small screwdriver to comfortably reach in and lightly press down locking clips.) Insert white wires to 'even' numbered terminal holes and striped wires into 'odd' terminal holes (Fig. 4-8).

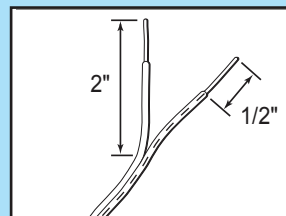
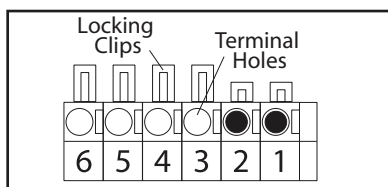

FIG. 4-7 Splitting and stripping.



- Confirm wire lock by lightly tugging on the wire. The wire should remain in the terminal hole.
- Do not install the white (lamp) cover at this time.

NOTE: Safe-T-Beam® alignment check must be performed following connection to electrical power (see page 19). DO NOT PLUG IN YET!

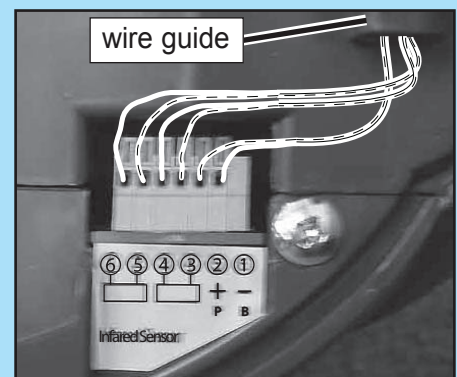

FIG. 4-8 Insert wires.

(Power Head With Rear Cover Removed)

5 CONNECTING TO POWER

FOR HELP-1.800.354.3643 OR WWW.GENIECOMPANY.COM

⚠ WARNING

- To reduce the risk of electrical shock, this equipment has a grounded type plug that includes a third (*grounding*) pin. This plug will only fit a grounded type outlet. If you do not have a grounded outlet, contact a qualified licensed electrician to install one. DO NOT alter the plug in any way. The door opener must be properly grounded in order to prevent personal injury and damage to the components.
- DO NOT remove motor cover. All work performed on motor must be done by a trained door system technician.

⚠ CAUTION

- **Check local building codes** to make sure that you are not required to have your garage door opener permanently wired, with circuit breaker protection. If building codes require door opener to be permanently wired have a qualified licensed electrician connect power with permanent wiring.

WITH GROUNDED PLUG:

Plug the opener into a properly grounded electrical outlet (Fig. 5-1).

WITH PERMANENT WIRING:

Instructions for Electrician.

- Remove power from circuit.
- Remove rear cover and motor cover.
 - Remove four motor cover screws (Fig. 5-2).
- Remove existing power cord and strain relief from the 7/8" dia. hole and discard (Fig. 5-3).
- Connect permanent wiring to power head using 7/8" diameter hole.
 - **White to white/black to black/ground to green.**
 - Use only UL recognized wire nuts.
- Wires inside the power head must be at least 6" in length.
- Replace motor cover and rear cover and re-energize the circuit.

NOTE: The Genie Company is not responsible for charges resulting from work performed by an independent electrician.

WITH POWER SUPPLIED:

Check Safe-T-Beam® alignment (Fig. 5-4).

- Insure that no part of door or its hardware is in path between lenses of **source** and **sensor**.
- Insure that tops of lenses are between 5" - 6" above the floor (Fig. 5-4). The brackets are flexible, and can be adjusted slightly if needed.
- Adjust the Red LED source by aiming the unit directly at the Green LED sensor. Use the adjustment screw located on the top of the source housing to make adjustments.
- The Red LED source will blink if there is a misalignment. When the LED units are aligned the Red LED will remain ON continuously.
- After the alignment is finished tighten the adjustment screws on Safe-T-Beam®.

FIG. 5-1 Connect to power.

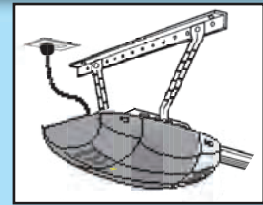

Motor Cover Screws



FIG. 5-2 Remove motor cover.

FIG. 5-3 Power cord strain relief.



⚠ CAUTION

- Do NOT use an extension cord.
- Do NOT use a portable generator. This product is designed to operate using standard household current.
- Do NOT use alternate power supplies.

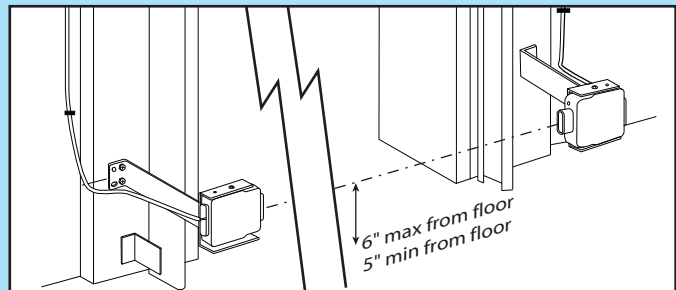

FIG. 5-4 Check Safe-T-Beam® alignment.

INFRARED PROTECTION FUNCTION

1. When the garage door is opening, its movement will not be influenced if the Safe-T-Beam® is obstructed.
2. If the Safe-T-Beam® is obstructed **before** the garage door fully closes, the door will not close.
3. When the garage door is closing, if Safe-T-Beam® is cut off by people or obstacle, the garage door will reverse automatically to its fully opened position. (Meanwhile, the opener light will keep blinking until door moves to its fully opened position.)
4. If the Safe-T-Beam® System fails, loses power, or is installed improperly, you will have to press and hold the wall control "close" button until the door reaches its fully closed position. The LED indicator light on the power head will be green and blink twice (Pattern: ☀☀ pause ☀☀ pause) to inform you to eliminate problem first. Otherwise, the door will reverse automatically to its fully opened position if you release the "close" button on the wall control during the closing movement.

⚠ WARNING

- Severe injury or death can result if the door closing force is set too high.
- Never increase the door closing force above the minimum required to move the door.
- Never adjust force to compensate for a sticking or binding door.
- Perform monthly CONTACT REVERSE TEST as described on page 22 and in Section 10.

SETTING & TESTING OPEN/CLOSE LIMITS

The OPEN (UP) and CLOSE (DOWN) door positions are controlled by making the adjustments on the panel located on the bottom of the power head. The adjustments that can be made are:

- Close Travel Limit,
- Open Travel Limit,
- Adjust Closing Force
- Adjust Opening Force
- Transmitter Programming

A) ENGAGE CHAIN/BELT CONNECTOR TO CARRIAGE

1. Press and hold the "Close Travel Limit" button until the chain or belt connector advances and engages to the Carriage Assembly (Fig. 6-2).

B) CLOSE TRAVEL LIMIT

1. Press and hold the "Close Travel Limit" button until the door is fully closed.
2. You can quickly press and release the "Close Travel Limit" button to move the door in small increments. You can also use the "Open Travel Limit" button to move the door slightly in the UP direction.
3. Door is fully closed when the bottom edge of door presses firmly onto the ground.
4. Once the door is in the desired position, press and hold the "Close SET Limit" button for 5 seconds. The LED indicator light will blink green once. This stores the closed position in memory.

C) OPEN TRAVEL LIMIT

1. Press and hold the "Open Travel Limit" button to move the door to its fully opened position. This starts the opener moving in the UP direction.
2. Hold the "Open Travel Limit" button until the door is in the fully opened position that you desire, then release this button.
3. You can quickly press and release the "Open Travel Limit" button to move the door in small increments. You can also use the "Close Travel Limit" button to move the door slightly in the DOWN direction.
4. Once the door is in the desired position, press and hold the "Open SET Limit" button for 5 seconds. The LED indicator light will blink green twice. This stores the opened position in memory.

Limit Controls location on power head.

NOTE: Set Close Travel Limit before setting Open Travel Limit for unit to operate normally.

Unless limits are being reset do not press set limit buttons.

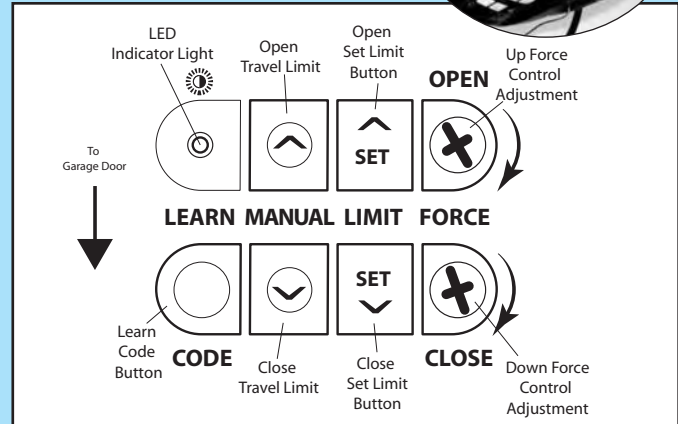
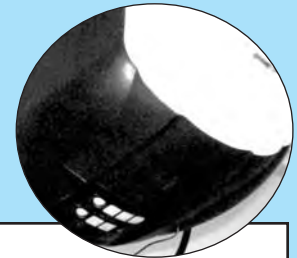

FIG. 6-1 Limit controls.

⚠ CAUTION

Failure to verify the engagement of the belt/chain connector will result in damage to rail components.

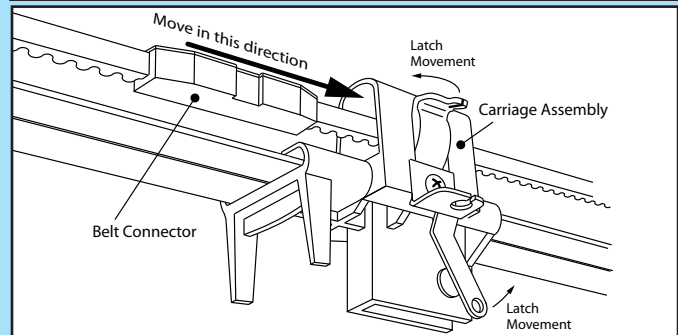
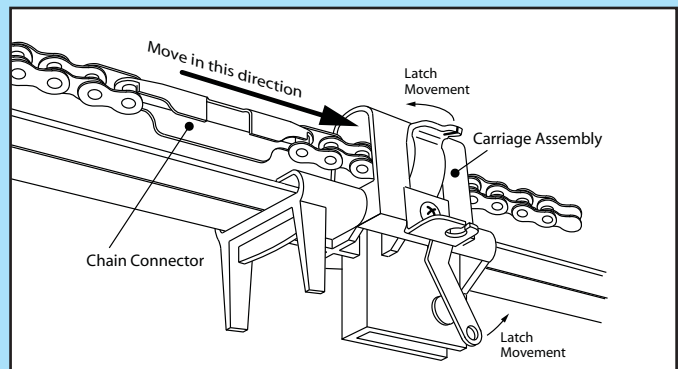

FIG. 6-2 Engage Chain/Belt Connector to Carriage.

⚠ CAUTION

Operation of the opener without the Chain or Belt Connector engaged to the Carriage Assembly will result in damage to rail components including the rail pulley.

CARRIAGE LOCK

The Carriage Lock can be manually engaged or disengaged.

- To disengage Carriage Lock
 - Pull handle downward **opener power head**.
- To engage Carriage Lock
 - Pull handle towards **door**.

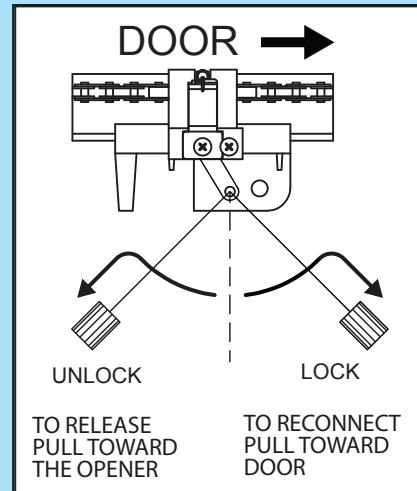

FIG. 6-3 Engage/Disengage Carriage Lock.

KEYED EMERGENCY RELEASE (PURCHASED SEPARATELY)

Obtain standard emergency release kit and **remove S-hook from the cable end** that attaches to the opener carriage.

1. Attach the emergency release cable loop end to the opener carriage as shown (FIG 6-4).

Properly connecting the release cable to the carriage fitting will enable the correct carriage release action for the opener.

⚠ WARNING

Improper connection of the emergency release cable to the opener carriage will result in a failure of the emergency release.

2. Follow the remaining installation instructions for the standard emergency release kit.
3. Test for correct operation of emergency release kit.

Keyed Emergency Release Operation Instructions

- Place key in slot.
- Rotate and **hold** key while lifting garage door 1 to 2 inches.
- Release key and continue opening garage door.

NOTE: The next normal operation of the opener or fully closing garage door manually will re-engage the emergency release mechanism.

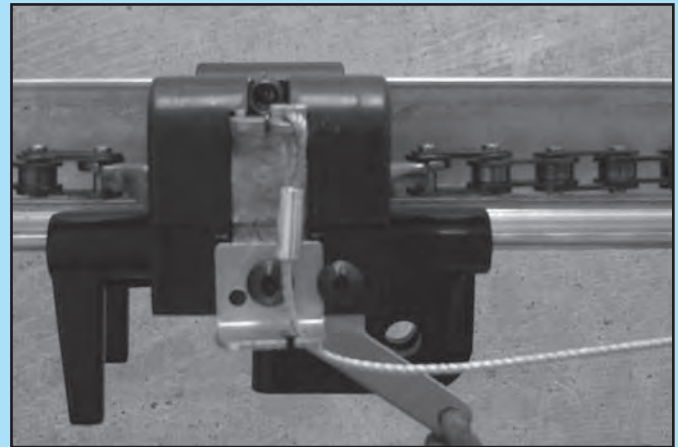







FIG. 6-4 Emergency release cable to carriage.

UP/DOWN FORCE

1. By turning the "Close Force Control"  clockwise, the **DOWN** force can be **increased**. By turning the "Close Force Control"  counter-clockwise, the **DOWN** force can be **decreased**. Set the **DOWN** force level at the minimum force required to close door without reversing.
2. Once the desired level is selected, this stores the necessary force level for the **DOWN** direction in memory.
3. By turning the "Open Force Control"  clockwise, the **UP** force can be **increased**. By turning the "Open Force Control"  counter-clockwise, the **UP** force can be **decreased**. Set the **UP** force level at the minimum force required to open door without stopping.
4. Once the desired level is selected, this stores the necessary force level for the **UP** direction in memory.

ERASE - OPEN/CLOSE TRAVEL LIMIT

1. Press and hold both of the "SET" buttons ( & ) together until the green indicator light blinks (about 5 seconds).
2. All close and open travel limit settings are erased. Then follow the steps above to reprogram close and open travel limits.

NOTE: The opener will not close the door automatically unless the Safe-T-Beam® System is installed.

CONTACT REVERSE TEST

The force adjustments and limit switch settings **MUST BE COMPLETED** before testing.

1. **Testing.**
 - Open garage door using Wall Control.
 - Place a 2" x 4" board (laid flat) under **center of garage door opening** (FIG. 6-6).
 - Close door using Wall Control.
 - When door contacts board, the door must stop (within 2 seconds) and reverse direction returning to open position.
2. **Adjustment.**
 - If the door does not properly reverse.
 - Check to see if door has "close" limit programmed. It should not have reached its "close" limit before hitting board.
 - If the door **STOPS** but does not reverse, decrease "**CLOSE FORCE**" control  setting slightly (turn it counter-clockwise).
 - Test again. Repeat as necessary until door reverses upon contacting board.

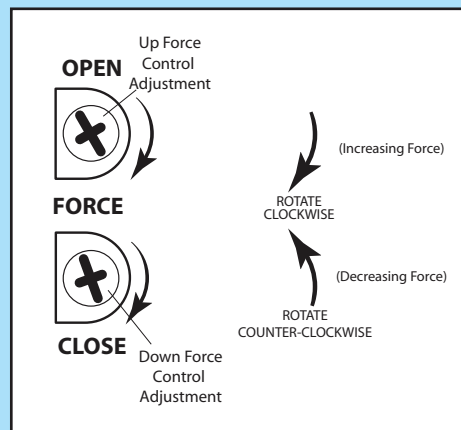

FIG. 6-5 Force Control Adjustment.

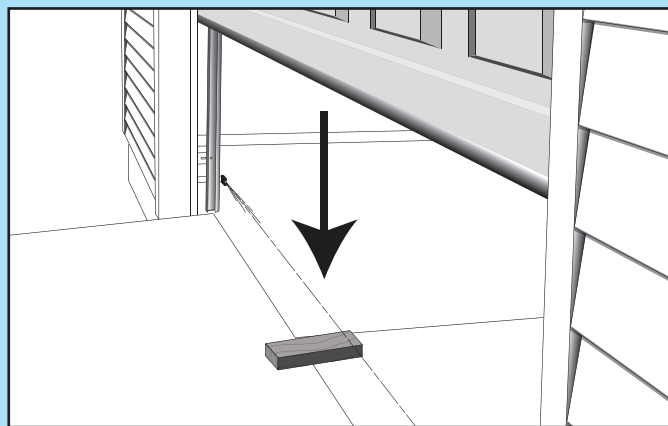

FIG. 6-6 2 x 4 under center of door opening.

7 PROGRAMMING REMOTE CONTROLS

⚠ WARNING

A moving door can cause serious injury or death.

1. Keep people clear of opening while door is moving.
2. Do NOT allow children to play with opener, including wall button, remote control, or Wireless Keypad.
3. During programming, the door opener could begin to run, so keep people and objects away from the moving door and its parts. To keep the door from moving, close the door and disconnect it from the Opener by pulling the Emergency Release.

NOTE: For remote control locate Box 3.

1a. Single Button Remote Programming.

NOTE: This opener can learn up to 7 transmitter buttons.

- Locate “Learn Code”  button and indicator LED on the power head (**Fig. 7-1**).
- Press and release “Learn Code” button.
 - Indicator LED will blink RED at a rate of twice per second.
- **Within 30 seconds**, push remote control button once.
 - Indicator LED will stop blinking and stay **ON**.
- Press remote control button again.
 - Red LED will go out. Remote is now programmed and ready for use.
- Press remote control button again, door will move.

1b. Multi Button Remote Programming.

NOTE: Each button on a multi-button remote is designed for use with 1 door. You cannot program 2 buttons to operate the same door, nor can you program 1 button to operate 2 doors. You can program a maximum of 7 different transmitters or wireless devices.

NOTE: Pushing two buttons on power head simultaneously will erase programmed memory and limits must be reset.

- For each button.
 - Program each button separately using the **Single Button Remote Programming steps**.

2. Operating.

- Press remote button once.
 - Door will move.
- Press button again.
 - Door will stop.
- Press button again.
 - Door will move in opposite direction.

NOTE: The door will stop automatically at the fully open or fully closed position.

LOST OR STOLEN REMOTE

1. Clear memory.

- Press and hold learn code button (on power head) for 10 seconds or until the red blinking indicator LED goes out.
- Program remaining or new remote controls as done previously. *Your door opener will no longer recognize any signal received from the missing remote control, or any other which has not been reprogrammed.*



NOTE: To program a Homelink® and Car2U® device follow the Homelink® or Car2U® instructions in your car owner's manual.

FCC and IC CERTIFIED

This device complies with FCC Part 15 and RSS 210 of Industry Canada. This equipment has been tested and found to comply with the limits for a Class B digital device, pursuant to Part 15 of the FCC Rules. These limits are designed to provide reasonable protection against harmful interference in a residential installation. This equipment generates, uses and can radiate radio frequency energy and, if not installed and used in accordance with the instructions, may cause harmful interference to radio communications. However, there is no guarantee that interference will not occur in a particular installation. If this equipment does cause harmful interference to radio or television reception, which may be determined by turning the equipment OFF and ON, the user is encouraged to try to correct the interference by one or more of the following measures:

- Re-orient or relocate the receiver antenna.
- Increase the separation between the opener and receiver.
- Connect the opener into an outlet on a circuit different from that to which the receiver is connected.
- Consult your local dealer.

Limit controls location on power head.

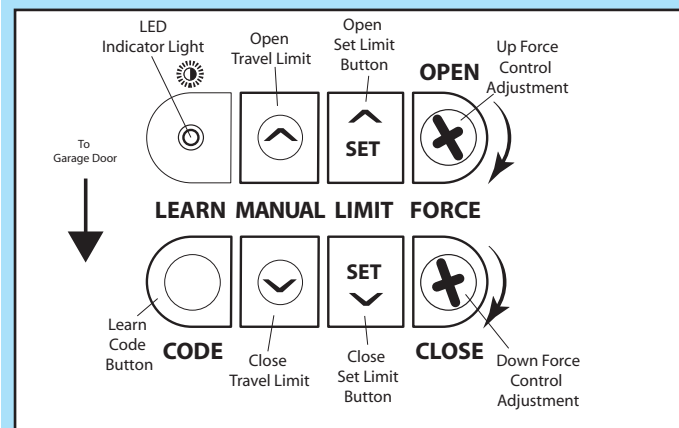
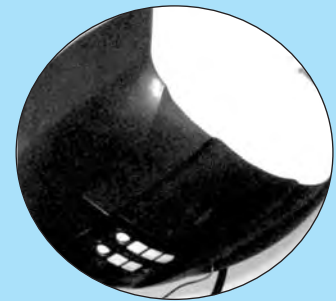

FIG. 7-1 Learn code button and LED

8 REMOTE CONTROL BATTERY REPLACEMENT AND VISOR CLIP INSTALLATION

1. Battery replacement.

- To open, gently push straight out on battery cover lock tab as shown. (Fig. 8-1).
- Slide open battery cover.
 - Remove old battery.
- Make sure new battery is facing proper direction (Match battery polarity with symbols inside battery housing) (Fig. 8-2).
 - Recommended replacement battery type: *Alkaline A23*, 12 volt.

NOTE: Batteries differ in care and maintenance. Follow the manufacturer's directions for battery maintenance, replacement, and use.

- Slip new battery into place.
 - Slide battery cover until it clicks shut.
- Operate remote to make sure it is working properly. (No re-programming is needed.)

2. Visor clip.

(The visor clip may come already installed.) You will have to install the visor clip if you choose to attach your remote to the car visor.

- Slide visor clip into back of remote control.
 - It will snap into place (Fig. 8-3).



FIG. 8-1 Open battery cover.

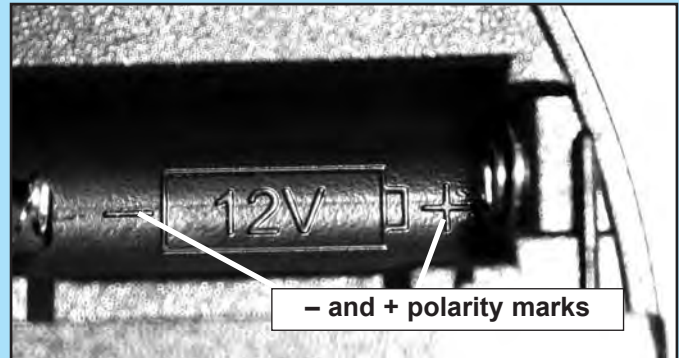

FIG. 8-2 Match battery polarity.



FIG. 8-3 Attach visor clip.

9 LIGHT BULB/LENS INSTALLATION

⚠ WARNING

For added safety and protection please unplug opener before installing light bulb.

NOTE: For lens covers locate Box 4.

1. Light bulb.

- Recommendations.
 - Do NOT use a short neck bulb.
 - Light bulbs should be no more than 60 Watts.
 - Use a **heavy duty service** bulb for longer life.
- Screw 1 bulb into each socket.

2. Lens.

- Select a white (lamp) cover.
- On the power head end nearest the garage door, line up lamp lens tabs on power head with corresponding slots in lens (Fig. 9-1).
- Slide lens onto power head. Make sure the tabs are fully engaged into lens slots (Fig. 9-2).
- Repeat for rear lens on power head.
- Plug power cord back into electrical outlet.
- Test lamp operation.

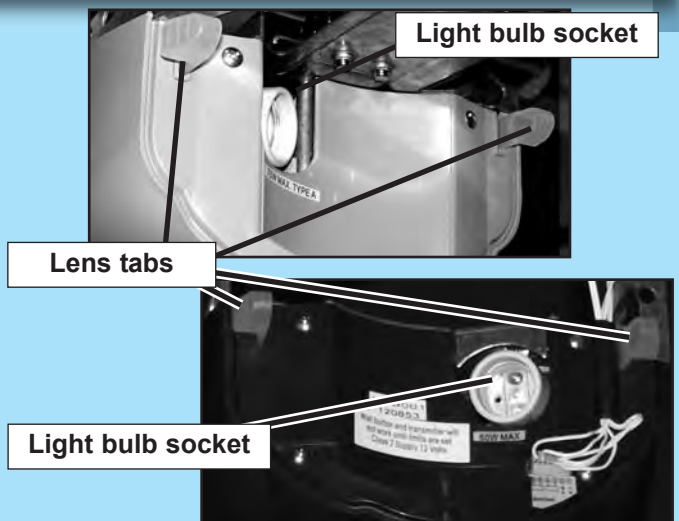

FIG. 9-1 Slide each lens onto motor cover.



FIG. 9-2 Fasten lens.

IMPORTANT SAFETY INSTRUCTIONS

⚠ WARNING:

To reduce the risk of severe injury or death:

1. READ AND FOLLOW ALL INSTRUCTIONS.
2. Never let children operate or play with the door controls. Keep the remote control away from children.
3. Always keep the moving door in sight and away from people and objects until the door is completely closed. **NO ONE SHOULD CROSS THE PATH OF THE MOVING DOOR.**
4. **NEVER GO UNDER A STOPPED, PARTIALLY OPEN DOOR.**
5. Test opener monthly. The door **MUST** reverse on contact with a 1-1/2" high object (or a 2" x 4" board laid flat) at the center of the doorway on the floor. After adjusting either the force or the limit of travel, retest the door opener. Failure to adjust the opener properly may cause severe injury or death.
6. When possible, use the emergency release only when the door is closed. Use caution when using this release with the door open. Weak or broken springs are capable of increasing the rate of door closure and increasing the risk of severe injury or death.
7. **KEEP DOORS PROPERLY BALANCED.** See your garage door Owner's Manual. An improperly balanced door increases the risk of severe injury or death. Have a trained door system technician make repairs to cables, spring assemblies, and other hardware.
8. **SAVE THESE INSTRUCTIONS.**

If you have any questions, please do not hesitate to contact Genie® customer service at:
1.800.354.3643

10 MAINTENANCE

⚠ WARNING

- Garage door hardware (springs, cables, brackets, pulleys, etc.) are under extreme pressure and tension.
- **DO NOT** attempt to repair or adjust door springs or any hardware, and **DO NOT OPERATE** garage door **automatically or manually** if door is improperly balanced or springs are broken.
 - **CONTACT A TRAINED DOOR SYSTEM TECHNICIAN.**

ROUTINE MONTHLY MAINTENANCE

1. **Door balance.**
 - With the door closed, pull emergency release knob (Carriage Lock) towards the opener to release door from carriage assembly.
 - Raise door manually approximately 3'- 4' and release.
 - Door should remain stationary or move **very** slightly.
 - If door moves quickly, **CONTACT A TRAINED DOOR SYSTEM TECHNICIAN.**
 - Close the door.
 - Pull emergency release knob towards door to engage carriage.
 - Operate door using remote.
 - Door will re-attach itself to carriage assembly.

2. **Contact reverse.**

- Place a 2" x 4" board laid flat on floor.
 - In center of garage door opening.
- Close door by using wall control or remote control.
 - Door fails to reverse on contact with board (See section 6 "CONTACT REVERSE.")
 - Opener still fails

CONTACT THE GENIE COMPANY OR AN AUTHORIZED GENIE® DEALER.

3. **Safe-T-Beam® System.**

- Red LED blinks.
 - check alignment (See section 5).

⚠ WARNING

Use Wall Control supplied with opener. Any other Wall Control can cause the opener to operate unexpectedly.

Opener circuit wiring diagram. This wiring diagram is for reference only.

Diagrama del circuito del abrelatas. Este diagrama es sólo para referencia.

Schéma de câblage de l'ouvreur. Ce schéma de câblage est indiqué à titre de référence uniquement.

⚠ WARNING
⚠ ADVERTENCIA
⚠ AVERTISSEMENT

Opening Cover May Cause Electric Shock.

Abrir la tapa puede causar choques eléctricos.

L'ouverture du couvercle peut entraîner des chocs électriques.

Disconnect power from opener prior to removing cover.

Desconecte la electricidad del abrepuertas antes de quitar la cubierta.

Coupez l'alimentation de l'ouvre-porte avant de retirer le couvercle.

POWER CORD
CORDON DE SECTEUR
CABLE ELÉCTRICO

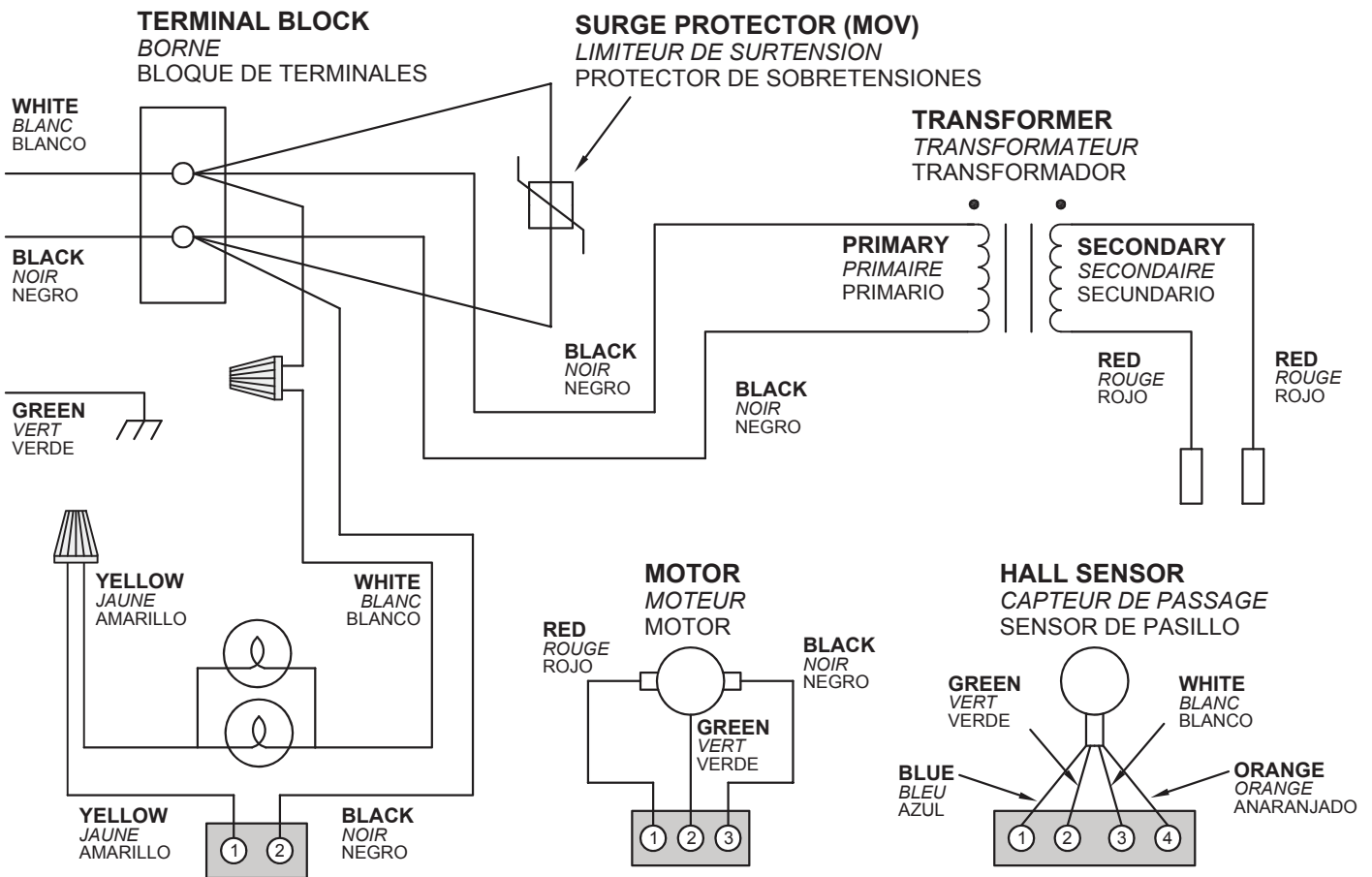

⚠ WARNING
⚠ ADVERTENCIA
⚠ AVERTISSEMENT

ELECTRICAL SHOCK
CHOQUE ELÉCTRICO
CHOC ÉLECTRIQUE

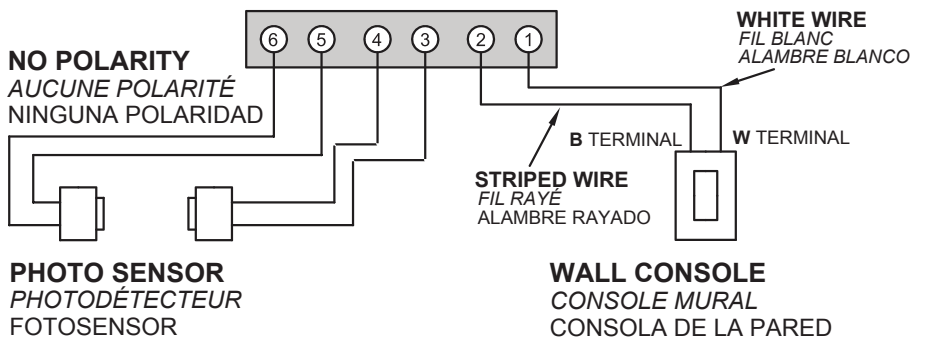

PROBLEM	WHAT TO DO
Opener does NOT run from Wall Console.	<ul style="list-style-type: none"> • Check power source. <ul style="list-style-type: none"> – Plug a lamp into outlet used for power head. If lamp works, power source is OK. – If not, check fuse or circuit breaker. • If power is OK. <ul style="list-style-type: none"> – Check connections at power head terminals and at Wall Console. • Check for reversed, broken, or cut wires. Staples can cut insulation and short wires. Repair or replace.
Opener runs, but door does NOT move.	<ul style="list-style-type: none"> • Make sure carriage is engaged to carriage slide. <ul style="list-style-type: none"> – Place carriage lever in lock position. • Check to make sure chain/belt is not broken or OFF its track. • Check FORCE ADJUSTMENT (See section 6). Door opener will NOT run more than 30 seconds each way if door does not move.
Opener works from Wall Console, but NOT from remote control.	<ul style="list-style-type: none"> • Program remote control code into receiver memory (See section 7). • Replace remote control battery (See section 8).
Remote control has less than 25 feet operating range or no operation.	<ul style="list-style-type: none"> • Relocate remote control inside car and or point remote control at garage door. • Replace battery (See section 8). • Reposition door opener antenna. • Red LED blinks while button is being pushed or LED does not come ON - battery is low, replace battery.
Door starts down, then STOPS and goes back up. OR Safe-T-Beam® System malfunction.	<ul style="list-style-type: none"> • If a NEW installation, check Door Arm position, (See section 2). • Check if Safe-T-Beam® Red LED is flashing. • Check Safe-T-Beam® system for beam obstruction or misalignment of lenses. Realign or replace Sensors. (See section 3) • Check "CLOSE FORCE" adjustment (See section 6). • Check garage door for binding. • If an operational problem exists, and opener will not run closed. The opener can be forced to close as follows (See section 5). Hold the wall console down until door is completely closed. • Disconnect the Safe-T-Beam® System from the opener and contact an authorized Genie® Dealer or The Genie Company at 1-800-35-GENIE.
Door starts down, then STOPS before it is closed. OR Door will only open.	<ul style="list-style-type: none"> • Check CONTACT REVERSE (See section 6). • Check garage door for binding. • Wires shorted. Staples can cut insulation and short wires. Repair or replace. • Check "CLOSE FORCE" adjustment (See section 6).
Door starts up, but STOPS before it's completely open.	<ul style="list-style-type: none"> • Be sure door, opener, and springs are in good repair, properly lubricated and balanced (See Maintenance section 10). • Check "OPEN" limit setting (See section 6). • Check "OPEN FORCE" adjustment (See section 6). • ▲ WARNING: If you suspect a problem with the garage door hardware or springs, contact an authorized Genie® Dealer or a trained door system technician, or contact The Genie Company at 1-800-35-GENIE.
Door will only run in close direction.	<ul style="list-style-type: none"> • Check door balance, condition, and door spring. • Check "OPEN FORCE" adjustment (See section 6). • ▲ WARNING: If you suspect a problem with the garage door hardware or springs, contact an authorized Genie® Dealer or a trained door system technician, or contact The Genie Company at 1-800-35-GENIE.
Door opener starts for no reason.	<ul style="list-style-type: none"> • Was a remote control lost or stolen? Erase all remote control codes from receiver memory and reprogram (See section 7). • Console stuck on Wall Console or remote. • Check CLOSE limit switch setting (See section 6). • Wires shorted. Staples can cut insulation and short wires. Repair or replace.
Noisy operation.	<ul style="list-style-type: none"> • Be sure all fasteners are tight. • Be sure door and opener are in good repair, properly lubricated and balanced (See Maintenance section 10).

Power head LED		Possible Problem	Solution
Red LED showing	Green LED showing		
OFF	OFF	Normal operation	None required
Continuous ON		<ul style="list-style-type: none"> • Programming incomplete 	<ul style="list-style-type: none"> • Complete programming
1 BLINK, Pause (Repeat)		<ul style="list-style-type: none"> • Transmitter has not learned 	<ul style="list-style-type: none"> • Program Remote
	1 BLINK, Pause (Repeat)	<ul style="list-style-type: none"> • Programming incomplete • Safe-T-Beam® detects obstruction going down • Door obstruction going down • Door obstruction going up 	<ul style="list-style-type: none"> • Set DOWN LIMIT programming • Check for obstruction, remove • Check for obstruction, remove. <ul style="list-style-type: none"> – Check door spring – Contact The Genie Company at 1-800-35-GENIE
	2 BLINKS, Pause (Repeat)	<ul style="list-style-type: none"> • Programming incomplete • Wire to power head or wire connection at power head is bad. • Safe-T-Beam® out of alignment • Continuous obstruction of Safe-T-Beam® sensor 	<ul style="list-style-type: none"> • Set UP LIMIT programming • Check power head wiring, check connections, <ul style="list-style-type: none"> – Replace or repair • Check Safe-T-Beam® alignment • Check for obstruction
	3 BLINKS, Pause (Repeat)	<ul style="list-style-type: none"> • Limits set backwards 	<ul style="list-style-type: none"> • Clear limits and reprogram (See section 6)
	4 BLINKS, Pause (Repeat)	<ul style="list-style-type: none"> • Wall console wire short • Wall console wires reversed in power head connector. 	<ul style="list-style-type: none"> • Check wall console and wiring. Staples can cut insulation and shorts wires. Repair or replace wall console and/or wiring. <ul style="list-style-type: none"> – Contact The Genie Company at 1-800-35-GENIE • Reverse wire placement in power head connector. (See section 3)
	5 BLINKS, Pause (Repeat)	<ul style="list-style-type: none"> • Chain/belt is too tight • Control system failure • Thermal Protector activated 	<ul style="list-style-type: none"> • Adjust chain/belt tension (See section 1). <ul style="list-style-type: none"> – Contact The Genie Company at 1-800-35-GENIE • Contact Genie® authorized dealer for service • Wait until Thermal Protector cools and resets. NOTE: The 5 BLINKS pattern will remain blinking until the next opener activation. If the Thermal Protector does not reset. <ul style="list-style-type: none"> – Contact Genie® authorized dealer for service.

TRANSMITTER COMPLIANCE STATEMENT

Transmitters comply with all United States and Canadian legal requirements as of the date of manufacture. No warranty is made that they comply with all legal requirements of any other jurisdiction. If transmitters are to be used in another country, the importer must determine compliance with any local laws and regulations which may differ from United States and Canadian requirements prior to use.

Los transmisores cumplen con todas las reglamentaciones legales de los Estados Unidos y del Canadá, en la fecha de fabricación. Ninguna garantía se da que cumplan con todas las reglamentaciones legales de ninguna otra jurisdicción. Si los transmisores se van a utilizar en otro país, el importador debe determinar si cumplen con las reglamentaciones y leyes locales que puedan ser diferentes a las reglamentaciones de los Estados Unidos y del Canadá, antes de usar los mismos.

Les émetteurs sont conformes à la réglementation américaine et canadienne à compter de leur date de fabrication. Aucune garantie n'est stipulée indiquant qu'ils sont conformes à toutes les prescriptions juridiques d'autres autorités. Si les émetteurs sont utilisés dans d'autres pays, il incombe à l'importateur d'en déterminer leur conformité aux lois et règles locales pouvant différer de celles des États-Unis et du Canada avant toute utilisation desdits émetteurs.

Sendegeräte entsprechen allen gesetzlichen Bestimmungen in den USA und Kanada zum Zeitpunkt der Herstellung. Wir übernehmen keine Gewährleistung für die Einhaltung aller gesetzlichen Bestimmungen in anderen Ländern. Sollen Sendegeräte in anderen Ländern eingesetzt werden, so muss der Importeur vor dem Gebrauch sicherstellen, dass die Sendegeräte auch solchen lokalen Bestimmungen entsprechen, welche von den Bestimmungen der USA und Kanadas abweichen.

截止于制造日期, 传动装置符合美国和加拿大的所有法律要求。不提供传动装置符合任何其他司法地区所有法律要求之担保。如果传动装置需在任何其他国家使用, 进口商必须在使用之前确定装置符合与美国和加拿大要求不同之所有地方法规条例。

トランスミッターは、製造日付けのアメリカ合衆国及びカナダの法的条件に準拠します。しかしながら、トランスミッターがアメリカ合衆国及びカナダ以外の国の法的条件に準拠するか否かは一切保証できません。トランスミッターがアメリカ合衆国及びカナダ以外の国で使用される場合、同製品の使用に先立つ法規制がこれらの国々と異なることがあるため、輸入者は同製品が輸入国の法規制に準拠することを確認しなければなりません。

트랜스미터들은 미국과 캐나다 전역에서 제조 날짜를 명기해야 하는 요구사항에 따라야 합니다. 기타 다른 관할권의 모든 법적인 요구 사항에 따라야 하는 책임은 없습니다. 만일 트랜스미터들이 기타 다른 지역에서 사용될 경우 수입업자는 사용하기에 앞서 미국과 캐나다와의 요구사항과는 다를지도 모르는 그 지역의 법과 조례에 따라야 할지의 여부를 결정해야 합니다.