

CONSTRUCTION MASTER® PRO

User's Guide

For Models:

4065 v3.1 Construction Master Pro

4080 v3.1 Construction Master Pro Trig

44080 v3.1 Construction Master Pro Desktop

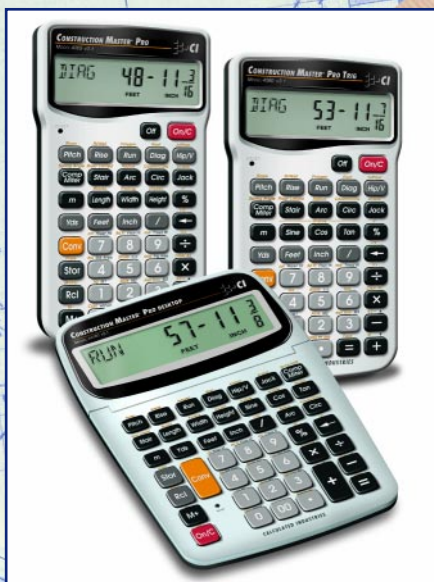

**CALCULATED
INDUSTRIES®**

CONSTRUCTION MASTER® PRO v3.1 USER'S GUIDE

This User's Guide helps you solve common construction math and material estimation problems using the latest *Construction Master Pro* calculators—three of the most powerful feet-inch-fraction calculators to date:

The ***Construction Master Pro III*** Series —

1. **Construction Master Pro (#4065 v3.1)**
2. **Construction Master Pro Trig (#4080 v3.1)**
3. **Construction Master Pro Desktop (#44080 v3.1)**

IMPORTANT: The *Construction Master Pro Trig* does not have **Block**, **Concrete Footing**, **Drywall**, or **Length**, **Width**, and **Height** functions. These keys are replaced with standard trigonometric keys.

INTRODUCTION

The *Construction Master Pro* line includes the most advanced feet-inch-fraction calculators *designed specifically for building pro's!*

The *Pro* calculators handle practically any problem involving measurements and can be used to save time, prevent errors, and accurately perform common building projects such as: estimating concrete volume, squaring-up foundations, framing roofs, ordering lumber, building stairs, walls, laying driveways, carpet or floor covering, figuring precise angle calculations, or simply working in feet-inch-fractions or decimal feet!

Your Calculator Helps You Solve:

- Dimensional Math Problems
- Conversions Between Feet-Inch-Fractions, Decimal Feet, Decimal Inches, and Yards
- Imperial/Metric Conversions
- Problems Involving All Common Fractions — $1/2"$ to $1/64"$!
- Area/Volume Calculations
- Board Feet/Lumber Calculations
- Circle Calculations
- Column/Cone Area and Volume
- Compound Miter Cuts for Crown Moulding
- Material Estimations and Costs
- Polygons
- Rake-Walls
- Right Angle/Triangle Solutions
- Roofing Materials
- Stair Layout (Risers/Treads)
- Studs
- Weight/Volume Conversions

Pro and Desktop Models (NOT AVAILABLE ON TRIG MODEL #4080)

Also Solve:

- Block/Bricks, Concrete Footings and Drywall
- Instant Square-up, Perimeter, Wall Area, Room Area and Volume

TABLE OF CONTENTS

GETTING STARTED	1
KEY DEFINITIONS	1
Basic Operation Keys	1
Convert Conv Key – <i>Unit Conversions and Second Functions</i>	1
Memory and Storage Functions.....	2
Recall Rcl Key.....	3
Dimensional Measurement Unit Keys.....	3
Area and Volume Keys (NOT AVAILABLE ON TRIG MODEL #4080).....	4
Weight Keys.....	5
Construction Project Keys and Functions.....	6
Block/Brick Function (NOT AVAILABLE ON TRIG MODEL #4080).....	6
Circular/Arc Function Keys	7
Column/Cone Function	8
Compound Miter/Crown Moulding Keys	8
Drywall Function (NOT AVAILABLE ON TRIG MODEL #4080).....	9
Footing Function (NOT AVAILABLE ON TRIG MODEL #4080).....	9
Polygon Function	9
Right Triangle/Roof Framing Keys.....	10
Hip/Valley and Jack Rafter Keys.....	11
Rake-Wall Function.....	13
Roof Materials/Covering Function.....	14
Stair Key	14
Studs Function	16
Trigonometric Keys (TRIG #4080 AND DESKTOP #44080 MODELS ONLY).....	16
ENTERING DIMENSIONS	18
Entering Linear Dimensions.....	18
Entering Square/Cubic Dimensions.....	18
SETTING FRACTIONAL RESOLUTION.....	20
Setting Fraction Resolution – <i>Using the Preference Setting Mode</i>	20
Converting a Fractional Value to a Different Resolution.....	21
CONVERSIONS (LINEAR, AREA, VOLUME)	22
Linear Conversions	22
Converting Feet-Inch-Fractions to Decimal Feet.....	22
Converting Decimal Feet to Feet-Inch-Fractions.....	22
Converting Fractional Inches to Decimal Inches	23
Converting Decimal Inches to Fractional Inches	23
Square Conversions	23

Cubic Conversions	23
PERFORMING BASIC MATH WITH DIMENSIONS	24
Adding Dimensions	24
Subtracting Dimensions	24
Multiplying Dimensions	24
Dividing Dimensions	24
Percentage Calculations	25
MEMORY OPERATION	25
Basic Cumulative Memory (M+).....	26
Permanent Storage Registers (M1 and M2).....	26
PAPERLESS TAPE OPERATION	27
EXAMPLES – USING THE CONSTRUCTION MASTER PRO.....	29
LINEAR MEASUREMENT EXAMPLES	29
Adding Linear Measurements	29
Cutting Boards	29
Window Measurement	30
Calculating the Center Point.....	30
AREA CALCULATIONS	31
Square Area (x^2)	31
Area of a Rectangular Room (LxW)	31
Using Multi-Function Width Key to Find Area, Square-up and Perimeter (NOT AVAILABLE ON TRIG MODEL #4080).....	31
VOLUME CALCULATIONS.....	32
Rectangular Containers (LxWxH)	32
Using the Multi-Function Height Key to Find Volume, Wall Area and Room Area (NOT AVAILABLE ON TRIG MODEL #4080)	32
Volume of a Cylinder.....	33
Volume of a Cone	33
WEIGHT/VOLUME CONVERSIONS	34
Weight Conversions.....	34
Weight per Volume/Volume Conversions.....	34
BLOCKS/BRICKS (NOT AVAILABLE ON TRIG MODEL #4080).....	35
Number of Blocks, Based on Entered Length and Height	35
Number of Blocks, Based on Entered Area	35
Number of Blocks, Based on Calculated Perimeter	36
Number of Blocks, Based on Entered Length	36
Number of “Face” Bricks	37
Number of “Paver” Bricks	37
BOARD FEET – LUMBER ESTIMATION	38
Total Board Feet – <i>With Dollar Cost</i>	38

Number of Board Feet Based on Entered Volume	38
CIRCLE AND ARC CALCULATIONS.....	39
Circumference and Area of a Circle.....	39
Arc Length – <i>Degree and Diameter Known</i>	39
Arc Length – <i>Chord Length and Segment Rise Known</i>	39
Arc Calculations – <i>Arc Length and Diameter Known</i>	40
ARCHED SEGMENT WALLS	41
Arched Segment Walls – <i>Arched Windows (No Base)</i>	41
Arched Segment Walls – <i>Arched Windows (With Base)</i>	42
Arched Segment Walls – <i>Chord Length and Segment Height Known</i>	43
COMPOUND MITER.....	45
Compound Miter Cuts	45
CONCRETE/PAVING	46
Volume of Concrete for a Driveway	46
Concrete Columns	47
Complex Concrete Volume	48
Polygon, Finding Angles Based on Entered Radius and Number of Sides	49
Concrete Footings (NOT AVAILABLE ON TRIG MODEL #4080)	50
Squaring-up a Foundation	51
DRYWALL (NOT AVAILABLE ON TRIG MODEL #4080).....	52
Number of Drywall Sheets for a Given Area.....	52
Number of Drywall Sheets for a Given Length	52
GRADE/SLOPE.....	53
Back-Fill on a Slope – <i>Percent of Grade Known</i>	53
RIGHT TRIANGLE AND ROOF FRAMING EXAMPLES	54
Roof Framing Definitions	55
Degree of Pitch	57
Percent Grade.....	57
Pitch Ratio or Slope	57
Common Rafter Length.....	58
Common Rafter Length – <i>Pitch Unknown</i>	58
Angle and Diagonal (Hypotenuse).....	59
Rise	59
Rise and Diagonal.....	59
Sheathing Cut	60
Regular Hip/Valley and Jack Rafters	60
Jack Rafters – <i>Using Other Than 16-Inch On-Center Spacing</i>	61

Irregular Hip/Valley and Jack Rafters – <i>Descending, with On-center Spacing Maintained</i>	62
Irregular Hip/Valley and Jack Rafters – <i>Ascending, with Jacks Mating at Hip/Valley</i>	64
Rake-Wall – <i>No Base</i>	66
Rake-Wall – <i>With Base</i>	67
ROOFING MATERIALS	68
Roof Covering – <i>Entering Pitch, Length and Width</i>	68
Roof Covering – <i>Entering Rise, Run (No Pitch) and Area</i>	69
STAIR LAYOUT EXAMPLES	70
Stair Layout Definitions	70
Stairs – <i>Given Only Floor-to-Floor Rise</i>	72
Stairs – <i>Given Only the Run</i>	74
Stairs – <i>Given Rise and Run</i>	75
Stairs – <i>Given Rise and Run, Using “Riser Limited” Function for Code Restrictions</i>	76
Baluster Spacing.....	77
STUDS	78
BASIC D:M:S AND TRIGONOMETRY EXAMPLES	78
Converting Degrees:Minutes:Seconds	78
Time Calculations Using D:M:S	78
TRIGONOMETRIC FUNCTIONS.....	79
Converting Percent Grade to D:M:S.....	80
Converting Tangent/Pitch to Angle.....	80
Converting Roof Angle in Degrees to Pitch in Inches.....	80
Angle – <i>Rise and Hypotenuse Known</i>	81
APPENDIX A – DEFAULT SETTINGS	82
APPENDIX B – PREFERENCE SETTINGS	83
How to Set Preferences.....	86
Accessing Preference Settings.....	86
APPENDIX C – CARE INSTRUCTIONS	89
APPENDIX D – IMPORTANT NOTES FOR OWNERS OF PREVIOUS CONSTRUCTION MASTERS	90
APPENDIX E – ACCURACY/ERRORS, AUTO SHUT-OFF, BATTERIES, RESET	91
ACCURACY/ERRORS.....	91
Error Codes.....	91
AUTO SHUT-OFF	91
BATTERIES.....	92
Replacing the Battery(ies).....	92
Battery Replacement Instructions.....	92

RESET	92
APPENDIX F – AREA/VOLUME FORMULAS.....	93
AREA FORMULAS.....	93
SURFACE AREA/VOLUME FORMULAS	94
REPAIR AND RETURN	95
WARRANTY	96
INDEX.....	99

GETTING STARTED

KEY DEFINITIONS

Basic Operation Keys

- On/C** **On/Clear** — Turns power on. Pressing once clears the display. Pressing twice clears all temporary values.
- Off** **Off** — Turns all power off, clearing all non-permanent registers. For desktop model 44080, press **Conv On/C** to turn power off.
- + - × ÷ =** Arithmetic operation keys.
- %** Four-function (+, -, x, ÷) percent key. (See **page 25** for examples.)
- 0 - 9** and **◻** Keys used for entering digits.
- 00** **(DESKTOP ONLY)** Enters "00" to save keystrokes (e.g., **1 00** to enter 100).
- ←** **Backspace Key** — Used to delete entries one keystroke at a time (unlike the **On/C** function, which deletes the entire entry).

Convert **Conv** Key — *Unit Conversions and Second Functions*

The **Conv** key is used to convert between measurement units or to access the second functions listed below:

- Conv ×** **Clear All** — Clears all values, including Memory. Resets all permanent entries to default values (except Preference Settings which are retained).
- Note: Use only when necessary, as it resets all stored values to factory defaults. See **page 82** for a listing of default values.*
- Conv %** x^2 — Squares the value in the display. For example, to square the value 10, enter **1 0** then **Conv %**.
- Conv ←** **Square Root Function (\sqrt{x})** — Used to find the square root of a non-dimensional or area value (e.g., **1 0 0 Conv ← = 10**).
- Conv /** $x10^y$ — Allows entry of an exponent. For example, **8 Conv / 1 4** is 8 times 10 to the 14th power.
- Conv ÷** $1/x$ — Finds the reciprocal of a number (e.g., **8 Conv ÷ = 0.125**).

Conv **−**

Change Sign (+/−) — Toggles the sign of the displayed value to positive or negative.

Conv **+**

Pi (π) — Constant = 3.141593

Conv **◐**

Degrees:Minutes:Seconds (dms◀▶deg) — Converts between D:M:S and decimal degree formats.

Conv **0**

Total Cost (Cost) — Calculates total material cost given a unit dimension and an entered Per Unit Cost.

Conv **Stor**

Access Preference Settings (Prefs) — Used to access various customizable settings, such as dimensional answer formats (see Preference Settings on **page 83**).

Memory and Storage Functions

M+

Cumulative Memory — Whenever the **M+** key is pressed, the displayed value will be added to the Memory. Other memory functions:

FUNCTION	KEYSTROKES
Add to Memory	M+
Subtract from Memory	Conv M+
Recall total in Memory	Rcl M+
Display/Clear Memory	Rcl Rcl
Clear Memory	Conv Rcl

Memory is semi-permanent, clearing only when you:

- 1) turn off the calculator;
- 2) press **Rcl** **Rcl**;
- 3) press **Conv** **Rcl**;
- 4) press **Conv** **X** (*Clear All*).

When memory is recalled (**Rcl** **M+**), consecutive presses of **M+** will display the calculated average and total count of the accumulated values.

Stor **1** – **3**

Storage Registers (M1) through (M3) — Stores the displayed value in non-cumulative, permanent Memory (e.g., **1** **0** **Stor** **1**). Good for storing a single value, for future reference (**Rcl** **1** **=** **10**).

*Note: Non-cumulative means it only accepts one value (does not add or subtract) and a second entered value will replace the first. Permanent means the value is stored even after the calculator is shut off. To delete a stored value, enter a new value or perform a Clear All (**Conv** **X**).*

Recall **Rcl** Key

The **Rcl** key is used to recall or review stored values (e.g., **Rcl Pitch** to recall a previously entered pitch value). It is also used in reviewing stored settings, or in Paperless Tape and Memory operation (see below).

Rcl **=** **Paperless Tape (Tape)** — Accesses the paperless tape mode (see “Paperless Tape” **page 27**), which keeps track of your past 20 entries. Useful for checking strings of numbers.

Rcl **Rcl** **Clear M+** — Displays and clears M+.

Rcl **M+** **Recall M+** — Displays value stored in M+.

Rcl **1** – **3** **Recall (M1) through (M3)** — Recalls the value stored in M1, M2, or M3.

Dimensional Measurement Unit Keys

The following keys are used for entering units of measure, with ease and accuracy:

Yds **Yards** — Enters or converts to *Yards*.

Feet **Feet** — Enters or converts to *Feet*. Also used with the **Inch** and **/** keys for entering Feet-Inch values (e.g., **6 Feet 9 Inch 1 / 2**).

*Note: Repeated presses of **Feet** after **Conv** toggle between Feet-Inches and Decimal Feet (e.g., **6 Feet 9 Inch 1 / 2 Conv Feet = 6.791667 Feet**; press **Feet** again to return to Feet-Inch-Fractions).*

Inch **Inches** — Enters or converts to *Inches*. Also used with the **/** key for entering fractional Inch values (e.g., **9 Inch 1 / 2**).

*Note: Repeated presses of **Inch** after **Conv** toggle between Fractional and Decimal Inches (e.g., **9 Inch 1 / 2 Conv Inch = 9.5 Inch**; press **Inch** again to return to Fractional Inches).*

/ **Fraction Bar** — Used to enter *fractions*. Fractions may be entered as proper (1/2, 1/8, 1/16) or improper (3/2, 9/8). If the denominator (bottom) is not entered, the calculator’s fractional resolution setting is automatically used (e.g., entering **1 5 / =** or **+ =** will display 15/16, based on the default fractional resolution setting of 16ths).

- m** **Meters** — Enters or converts to *Meters*.
- Conv** **7** **Centimeters (cm)** — Enters or converts to *Centimeters*.
- Conv** **9** **Millimeters (mm)** — Enters or converts to *Millimeters*.
- Conv** **2** **Acres (Acre)** — Enters or converts (a square value) to *Acres*.
- Conv** **8** **Board Feet (Bd Ft)** — Enters or converts cubic values to *Board Feet*. One Board Foot is equal to 144 Cubic Inches.

Area and Volume Keys (NOT AVAILABLE ON TRIG MODEL #4080)

Length **Length** — Enters a length for calculation of area or volume.

Width **Width** — A multi-function key used to enter a width for calculation of area or volume (if a length and height are also entered). Consecutive presses of this key display or calculate:

Press Result

- | | |
|---|---|
| 1 | Displays Entered Width (WDTH) |
| 2 | Area (AREA) |
| 3 | Square-up (SQUP) |
| 4 | Perimeter (PER) |
| 5 | Redisplays Entered Length (LNTH) |
| 6 | Redisplays Entered Width (WDTH) |

Height **Height** — A multi-function key used to enter a height for calculation of volume (if a length and width are also entered). Consecutive presses of this key display or calculate:

Press Result

- | | |
|---|---|
| 1 | Displays Entered Height (HGHT) |
| 2 | Volume (VOL) |
| 3 | Wall Area (WALL) |
| 4 | Total Room Area (ROOM) |
| 5 | Redisplays Entered Length (LNTH) |
| 6 | Redisplays Entered Width (WDTH) |

Weight Keys

Conv **1** **Kilograms (kg)** — Enters or converts (a weight or volume value) to *Kilograms*. A dimensioned volume will convert using the stored Weight per Volume value.

Conv **3** **Metric Tons (met tons)** — Enters or converts (a weight or volume value) to *Metric Tons*. A dimensioned volume will convert using the stored Weight per Volume value.

Conv **4** **Pounds (lbs)** — Enters or converts (a weight or volume value) to *Pounds*. A dimensioned volume will convert using the stored Weight per Volume value.

Conv **6** **Tons (tons)** — Enters or converts (a weight or volume value) to *Tons*. A dimensioned volume will convert using the stored Weight per Volume value.

Stor **0** **Store Weight per Volume (wt/vol)** — Stores a new *Weight per Volume* value as Tons per Cubic Yard or other format, as listed below:

Note: After entering a value and pressing **Stor** **0**, continue pressing the **0** digit key until you've reached the desired weight per volume format. To recall your setting, press **Rcl** **0**.

- Ton Per CU YD
- LB Per CU YD
- LB Per CU FEET
- MET Ton Per CU M
- kG Per CU M

This value is permanently stored until you change it or perform a *Clear All* (**Conv** **X**).

Construction Project Keys and Functions

The following Construction Project Keys and Functions help you instantly figure quantities and costs of materials, so you can build like a pro!

Block/Brick Function (NOT AVAILABLE ON TRIG MODEL #4080)

The *Blocks* function helps you quickly estimate the quantity of blocks or bricks required for building walls, walkways or other areas.

Conv **Length**

Number of Blocks or Bricks (Blocks) —

Calculates the number of *blocks (or bricks)* based on:

- an entered or calculated linear value
- an entered or calculated area
- an entered value in **Length**
- values entered in **Length** and **Height** (solved area)

Uses a standard block/mortar area of 128 Square Inches and a block length of 16 Inches. This function can also be used for calculating the number of “face” or “paver” bricks by storing a brick size (see below).

Stor **4**

Store Block or Brick Size (Blk Size) — Used to store: (1) a block area *other than the default block area of 128 Square Inches* (e.g., **1 2 0 Inch Inch Stor 4** stores an area of 120 Square Inches) and (2) a block length *other than the default block length of 16 Inches* (e.g., **1 8 Inch Stor 4** stores a length of 18 inches). These values are permanently stored until you change them or perform a Clear All (**Conv X**). To recall the stored settings, press **Rcl 4** (repeated presses of **Rcl 4** toggle between block area and block length).

*Note: For Brick Estimates — You may also enter a brick size using **Stor 4**. For example, when building with standard “face” bricks, enter a brick size of 21 Square Inches (**2 1 Inch Inch Stor 4**) or store a “paver” brick size of 32 Square Inches (**3 2 Inch Inch Stor 4**); based on Modular U.S. brick size of 3-5/8 Inches x 2-1/4 Inches x 7-5/8 Inches, including 3/8-inch mortar = 4 Inches x 2-5/8 Inches x 8 Inches).*

Circular/Arc Function Keys

The circle key helps you quickly solve circular area, volume or arc problems.

Circ **Circle** — Displays and calculates the following values, given an entered circle diameter* or radius:

- Diameter (**DIA**)
- Circle area (**AREA**)
- Circumference (**CIRC**)

*To enter a diameter (e.g., 10 Feet), press **1** **0** **Feet** **Circ**.

Conv **Arc** **Radius** — Enters or calculates the *circle radius* (e.g., **5** **Feet** **Conv** **Arc**).

Arc **Arc Length or Degree of Arc** — A multi-function key that enters or calculates *Arc Length* or *Degree of Arc*, and further solves for additional circular/arc values, including arched segment walls (based on the stored On-center spacing), listed below.

<u>Press</u>	<u>Result</u>
1	Arc Length or Degree of Arc (ARC)
2	Chord Length (CORD)
3	Segment Area (SEG)
4	Pie Slice Area (PIE)
5	Segment Rise (RISE)
6	Stored On-Center Spacing (OC)
7	Length of Arched Wall 1* (AW 1)

* The calculator will calculate arched segment wall lengths (if applicable) with consecutive presses of the **Arc** key until it reaches the last wall length.

Run **Run (Chord Length)** — Enters or calculates the *Chord Length*. Used in conjunction with an entered segment rise to solve for the radius of a circle or with an entered radius to solve for the segment rise.

Rise **Rise (Segment Rise)** — Enters or calculates the *segment rise*. Used in conjunction with an entered Chord Length to solve for the radius of a circle or with an entered radius to solve for the Chord Length.

Column/Cone Function

The Column and Cone function helps you quickly estimate volume and surface area of columns or cones.

Conv **Circ**

Column and Cone (Column/Cone) — With an entered diameter and height, the first and second presses of **Circ** (following **Conv**) will calculate the total volume and surface area of a *Column*; the third and fourth consecutive presses of **Circ** calculate the total volume and surface area of a *Cone*.

For Trig Model (#4080) Users:

As this model does not have a **Height** key, you must enter the height using the **Rise** key.

Compound Miter/Crown Moulding Keys

The *Construction Master Pro* also calculates compound miter cut angle solutions for cutting and installing crown moulding on a wall. The Compound Miter function can also be used for finding angle cuts for many types of compound miter problems, such as siding, railing and trim.

Comp Miter

Compound Miter — With stored spring (crown) angle and entered wall corner angle*, consecutive presses of **Comp Miter** will calculate the following:

Press Result

- 1 Miter Angle (**MITR**)
- 2 Bevel Angle (**BEVL**)
- 3 Redispays Stored Spring Angle (**SPRG**)
- 4 Redispays Entered Wall Corner Angle (**CRNR**)

* Wall Corner Angle entries of less than 25 into **Comp Miter** will be assumed to be the number of sides of a polygon; in this case, the calculator will calculate the unknown Wall Corner Angle first, then proceed with the above angle calculations.

Stor **Comp Miter**

Store Spring Angle (Spring Angle) — Stores a value other than the default spring (crown) angle of 45° (e.g., **3 8 Stor Comp Miter** stores 38° spring angle). This value is permanently stored until you change it or perform a *Clear All* (**Conv X**). To recall the stored setting, press **Rcl Comp Miter**.

Drywall Function (NOT AVAILABLE ON TRIG MODEL #4080)

Conv **Height** **Drywall Sheets (Drywall)** — Calculates the number of 4 x 8, 4 x 9, and 4 x 12 *sheets* for an entered or calculated area.

Footing Function (NOT AVAILABLE ON TRIG MODEL #4080)

The Footing function helps you quickly estimate the volume of concrete required for concrete footings.

Conv **Width** **Footing** — Calculates total quantity of concrete required for *concrete footings* based on an entered wall length and footing size. Size based on the default footing size of 264 Square Inches (industry standard).

Stor **6** **Store Footing Area (Ftg Area)** — Used to store a value *other than the default footing size of 264 Square Inches* (e.g., **1** **2** **8** **Inch** **Inch** **Stor** **6** stores a footing size of 128 Square Inches). This value is permanently stored until you change it or perform a *Clear All* (**Conv** **X**). To recall the stored setting, press **Rcl** **6**.

Polygon Function

The Polygon function is handy for calculating multi-sided shapes (such as found in concrete applications).

Conv **Run** **Polygon** — With an entered diameter or radius and number of sides of a polygon-shaped figure, **Conv** **Run**, calculates the following:

Press Result

- | | |
|---|--|
| 1 | Full Angle (FULL) |
| 2 | Bi-Sect, or Half Angle (HALF) |
| 3 | Side Length (SIDE) |
| 4 | Perimeter of Polygon (PER) |
| 5 | Area of Polygon (AREA) |
| 6 | Radius* (RAD) |
| 7 | Redisplays Entered Number of Sides (SIDE) |

*Solves radius for an entered diameter or redisplays the entered radius.

Right Triangle/Roof Framing Keys

Right Triangle:

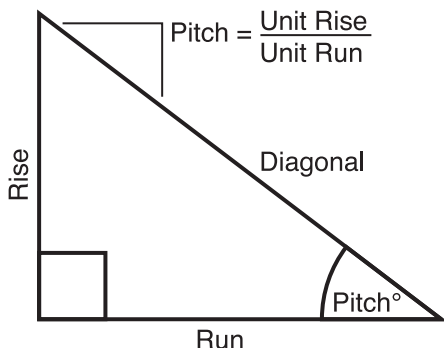

Using the Pythagorean theorem, the top row of keys on your *Construction Master Pro* will calculate instant solutions in dimensional format to right triangle problems (particularly, roof framing).

The *Construction Master Pro's* keys are labeled in easy to remember roofing terms. The right triangle is calculated simply by entering two of four variables: Rise, Run, Diagonal, or Pitch.

Pitch

Pitch — Enters or calculates the *Pitch* (slope) of a roof (or right triangle). Pitch is the amount of “rise” over 12 Inches (or one meter) of “run.” Pitch may be entered as:

- a dimension: **9** **Inch** **Pitch**
- an angle or degrees: **3** **0** **Pitch**
- a percentage (percent grade): **7** **5** **%** **Pitch**
- a pitch ratio: **0** **7** **5** **Conv** **Pitch**

Once a Pitch in one of the above formats is entered, consecutive presses of **Pitch** will convert to the remaining Pitch formats listed above (e.g., Pitch in Inches will convert to Pitch Degrees, Percent Grade and Pitch Ratio/Slope).

Note: An entered (vs. calculated) pitch is a **permanent** entry. This means that it will remain stored even after you turn the calculator off. To change the Pitch, simply enter a new Pitch value.

In contrast, a **calculated** Pitch value is **not permanently stored**. This means that the calculator will return to the Pitch value you **last entered** when you clear the calculator or press **On/C** twice.

Conv **Pitch**

Pitch Ratio or Slope (Slope) — Enters the *Pitch* as a ratio or *Slope* of a roof (or right triangle). For example, 0.58 slope is entered as **5 8 Conv Pitch**.

Rise

Rise — Enters or calculates the *Rise* or vertical leg (height) of a right triangle.

Run

Run — Enters or calculates the *Run* or horizontal leg (base) of a right triangle.

Diag

Diagonal — Enters or calculates the *diagonal* leg (hypotenuse) of a right triangle. Typical applications are “squaring up” slabs or finding common rafter lengths. Additional presses of the **Diag** key will also display plumb and level cut angles in degrees.

Note: The Common rafter calculation is the “point-to-point” length and does not include the overhang or ridge adjustment.

Hip/Valley and Jack Rafter Keys

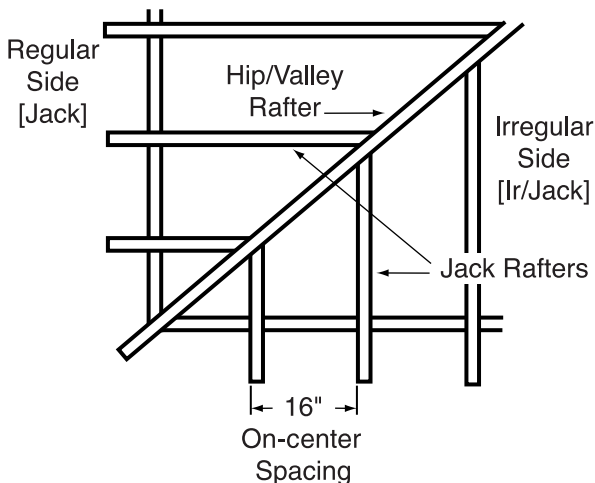

The *Construction Master Pro* uses the Rise, Run, Diagonal, Pitch and On-center spacing values to calculate *Regular* and *Irregular* Hip/Valley and Jack rafter lengths (excluding wood thickness, etc.).

When calculating Regular and Irregular Jack rafter lengths, you will see the letters “JK” (Regular pitch side) or “IJ” (Irregular pitch side) and the corresponding jack number to the left of your calculator display. This will help you keep track of the descending sizes and which side the corresponding rafter is based on.

Hip/V

Hip/Valley Rafter — Finds the Regular or Irregular Hip/Valley rafter length.

- **Regular Hip/Valley Length:** After right triangle/rafter values are entered or calculated (e.g., Pitch, Rise, Run), pressing **Hip/V** will calculate the length of the *Regular* Hip/Valley rafter.
- **Irregular Hip/Valley Length:** If an irregular pitch is entered (see next definition), pressing **Hip/V** will calculate the *Irregular* Hip/Valley rafter length. (An Irregular or “non-standard” roof has two different Pitches/Slopes.)
- Subsequent presses of the **Hip/V** key will also display plumb, level, and cheek cut angle values in degrees.

Conv Hip/V

Irregular Pitch (Ir/Pitch) — Enters the irregular or secondary pitch value used to calculate lengths of the irregular hip/valley and jack rafters.

You may enter the irregular pitch as:

- a dimension: **9** **Inch** **Conv** **Hip/V**
- an angle: **3** **0** **Conv** **Hip/V**
- a percentage: **7** **5** **%** **Conv** **Hip/V**

Note: An entered irregular pitch can be recalled by pressing **Rcl** **Conv** **Hip/V**.

Jack

Jack Rafters — Finds the descending *Jack* rafter sizes for *regular* pitched roofs, based on the stored On-center spacing and previously entered or calculated right triangle/rafter values (e.g., pitch, rise, run).

Repeated presses of the **Jack** key will display the incremental jack adjustment, all the rafter sizes (on the **Regular** pitch side) as well as display the plumb, level, and cheek cut angle values. Additional presses will display the rafter sizes on the **Irregular** pitch side (if an Irregular Pitch was entered; see above), or repeat the previously displayed values.

(Cont'd)

(Cont'd)

Note: You may set your calculator to display the Jack Rafter lengths in either ascending or descending order (see Preference Settings on **page 83**).

Note: You may set your calculator to “mate up” with the Jack Rafters, rather than using the entered or default On-center spacing for both sides (see Preference Settings on **page 83**).

Stor **5**

Store On-center (o.c.) Spacing — Used to store a value *other than the default of 16 Inches On-center* (e.g., **1** **8** **Inch** **Stor** **5** stores an 18-inch On-center) for Jack Rafter calculations. Press **Rcl** **5** to review the stored value.

Conv **Jack**

Irregular Side Jacks (Ir/Jack) — Operates same as **Jack**, but displays the rafter values from the *Irregular* pitched side first.

Rake-Wall Function

Conv **Rise**

Rake-Wall (R/Wall) — This function finds the stud sizes in a *Rake-Wall* based on calculated or entered values for pitch, rise and/or run. Repeated presses of **Rise** will display the various sizes. The sizes can be displayed in either descending (from longest to shortest) or ascending (from shortest to the longest) order, depending upon your preference setting (see Preference Settings on **page 83**). If a dimensional value is entered before pressing **Conv** **Rise**, this value will be taken as the Rake-Wall base size and automatically added to the various rafter lengths.

Stor **5**

Store On-center (o.c.) Spacing — Used to store a value *other than the default of 16 Inches On-center* (e.g., **1** **8** **Inch** **Stor** **5** stores an 18-inch On-center) for Rake-Wall stud calculations. Press **Rcl** **5** to review the stored value.

Roof Materials/Covering Function

The *Construction Master Pro's Roof* function provides a quick calculation of roof area, number of squares and bundles, and number of 4 x 8 sheets required for roof coverage.

Conv **Diag**

Roof — Given an entered Pitch (or Rise and Run) and plan area (or Length and Width), calculates the following:

Press **Result**

- 1 Roof Area (**ROOF**)
- 2 Number of Roof Squares (**SQRS**)
- 3 Number of Roof Bundles (**BNDL**)
- 4 Roof Bundle Size* (**B-SZ**)
- 5 Number of 4 x 8 Sheets (**4X8**)
- 6 Pitch (**PTCH**)
- 7 Plan Area (**PLAN**)

**Roof bundle size is 33.33 Square Feet.*

Stair Key

The *Construction Master Pro* easily calculates stair layout solutions. With entered values for floor-to-floor rise and/or run, it will calculate Riser, Tread, Stringer, and Incline Angle values simply by pressing the **Stair** key.

Stair

Stair — A multi-function key that uses a stored Riser Height, stored Tread Width, stored Headroom Height and Floor Thickness, and entered Rise and Run values to calculate and display the following:

Press **Result**

- 1 Actual Riser Height (**R-HT**)
- 2 Number of Risers (**RSRS**)
- 3 Riser Overage/Underage (**R+/-**)
- 4 Tread Width (**T-WD**)
- 5 Number of Treads (**TRDS**)
- 6 Tread Overage/Underage (**T+/-**)
- 7 Stairwell Opening (**OPEN**)
- 8 Stringer Length (**STRG**)
- 9 Incline Angle* (**INCL**)
- 10 Run of Treads (**RUN**)
- 11 Floor-to-Floor Rise (**RISE**)

(Cont'd)

(Cont'd)

Press Result

12	Stored (Desired) Riser Height (R-HT STORED)
13	Stored (Desired) Tread Width (T-WD STORED)
14	Stored Headroom (HDRM STORED)
15	Stored Floor Thickness (FLOR STORED)

Note: Default values are 7-1/2 Inches for Desired Riser Height and 10 Inches for Desired Tread Width, 10 Inches for Floor Thickness, and 6 Feet 8 Inches for Headroom Height.

Note: It is not possible for the calculator to include the nose/overhang measurement. Thus, you need to adjust for this measurement per local codes.

*If the inclination angle exceeds the stored riser height and Tread Width ratio by 10%, the yield symbol will appear, indicating a steep incline.

Stor **7**

Store Desired Riser Height (Riser Ht) — Stores a value other than the default desired stair riser height of 7-1/2 Inches (e.g., **8** **Inch** **Stor** **7** stores an 8-inch desired stair riser height). To recall the stored setting, press **Rcl** **7**.

Stor **8**

Store Floor Thickness/Height (Floor Ht) — Stores a value other than the default desired floor thickness of 10 Inches (e.g., **8** **Inch** **Stor** **8** stores an 8-inch desired floor thickness). To recall the stored setting, press **Rcl** **8**. This is used, along with stored headroom height, for calculating the length of the stairwell opening.

Stor **9**

Store Desired Tread Width (Tread W) — Stores a value other than the default desired stair Tread Width of 10 Inches (e.g., **1** **2** **Inch** **Stor** **9** stores a 12-inch desired stair Tread Width). To recall the stored setting, press **Rcl** **9**.

Conv **Stor** **Stor**
Stor **Stor**

Set Headroom Height — Sets the desired Headroom Height for calculation of the stairwell opening. Default is 6 Feet 8 Inches. Use the **+** key to increase and the **-** key to decrease the stored headroom height. See Preference Settings instructions on **page 86**.

Riser Limited — Used for situations when the riser height is limited by local code. When you press **Conv** **Stair**, the calculator will recalculate stair values so that the actual Riser Height will not exceed your stored desired Riser Height (e.g., it will never exceed the stored desired Riser Height of 7-1/2 Inches, if 7-1/2 Inches is the value stored using **Stor** (7)). To compensate for this limitation, the calculator will add one to the number of risers.

Studs Function

The *Construction Master Pro* also calculates the number of studs required for a wall using an entered length and stored On-center spacing value.

Conv (5)

Studs — Calculates the number of studs for an entered or displayed linear value. Based on the stored On-center spacing (16 inches is the default).

Trigonometric Keys (TRIG #4080 AND DESKTOP #44080 MODELS ONLY)

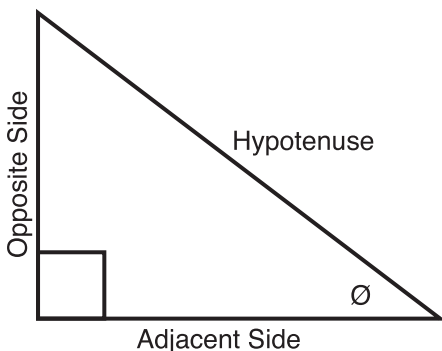

$$\text{Tangent } \emptyset = \frac{\text{Opposite}}{\text{Adjacent}}$$

$$\text{Sine } \emptyset = \frac{\text{Opposite}}{\text{Hypotenuse}}$$

$$\text{Cosine } \emptyset = \frac{\text{Adjacent}}{\text{Hypotenuse}}$$

The *Trig* model (#4080) and *Desktop* (#44080) calculators have standard trigonometric keys, in addition to right triangle/rafter keys (e.g., Rise, Run, Diagonal), for advanced right triangle mathematics.

The Sine, Cosine and Tangent of an angle are defined in relation to the sides of a right triangle.

Using the **Conv** key with the trigonometric function displays the inverse (Arcsine, Arccosine, and Arctangent). These are used to find the angle for the Sine, Cosine, or Tangent value entered.

Sine **Sine Function** — Calculates the *Sine* of an entered degree or non-dimensioned* value.

Conv **Sine** **Arcsine (\sin^{-1})** — Calculates the angle for the entered or calculated Sine value.

Cos **Cosine Function** — Calculates the *Cosine* of a degree or non-dimensioned* value.

Conv **Cos** **Arccosine (\cos^{-1})** — Calculates the angle for the entered or calculated Cosine value.

Tan **Tangent Function** — Calculates the *Tangent* of a degree or non-dimensioned* value.

Conv **Tan** **Arctangent (\tan^{-1})** — Calculates the angle for the entered or calculated Tangent value.

**Cannot use on dimensioned values.*

ENTERING DIMENSIONS

Entering Linear Dimensions

When entering Feet-Inch-Fraction values, enter dimensions from largest to smallest — e.g., Feet before Inches, and Inches before Fractions. Enter Fractions by entering the numerator (top), pressing **7** (fraction bar key), and then the denominator (bottom).

Note: If a denominator is not entered, the fractional setting value is used.

Examples of Entering Linear Dimensions:

DIMENSION	KEYSTROKES
Clear calculator 5 Feet 1-1/2 Inch	On/C 5 Feet 1 Inch 1 / 2
Clear calculator 5 Yards	On/C 5 Yds
Clear calculator 17.5 Meters	On/C 1 7 . 5 m

Entering Square/Cubic Dimensions

The *Construction Master Pro* lets you easily enter Square and Cubic values. Simply press a dimensional unit key *two* times to label a number as a Square value, or *three* times to label a Cubic value.

Note: If you pass the desired dimensional format, keep on pressing the dimensional unit key until the desired result is displayed again.

Enter Square and Cubic dimensions in the following order:

- (1) Enter numerical value (e.g., **1** **0** **0**).
- (2) Press desired unit key (e.g., **Feet**) to label value as “linear”.

KEYSTROKE	DISPLAY
On/C On/C	0.
1 0 0 Feet	100 FEET

- (3) Second press of unit key (e.g., **Feet** **Feet**) labels value as “Square”.

KEYSTROKE	DISPLAY
On/C On/C	0.
1 0 0 Feet Feet	100 SQ FEET

- (4) Third press of unit key (e.g., **Feet** **Feet** **Feet**) labels value as “Cubic”.

KEYSTROKE	DISPLAY
On/C On/C	0.
1 0 0 Feet Feet Feet	100 CU FEET

Note: Feet-Inches format cannot be used to enter Square or Cubic values.

Examples of Entering Square and Cubic Dimensions:

YARDS

Yds Yds — **Square Yards**

(e.g., **5 Yds Yds** will display 5 sq yd).

Yds Yds Yds — **Cubic Yards**

(e.g., **5 Yds Yds Yds** will display 5 cu yd).

FEET

Feet Feet — **Square Feet**

(e.g., **5 Feet Feet** will display 5 sq FEET).

Feet Feet Feet — **Cubic Feet**

(e.g., **5 Feet Feet Feet** will display 5 cu FEET).

INCHES

Inch Inch — **Square Inches**

(e.g., **5 Inch Inch** will display 5 sq INCH).

Inch Inch Inch — **Cubic Inches**

(e.g., **5 Inch Inch Inch** will display 5 cu INCH).

METERS

m m — **Square Meters**

(e.g., **5 m m** will display 5 sq M).

m m m — **Cubic Meters**

(e.g., **5 m m m** will display 5 cu M).

CENTIMETERS

Conv 7 7 — **Square Centimeters**

(e.g., **5 Conv 7 7** will display 5 sq CM).

Conv 7 7 7 — **Cubic Centimeters**

(e.g., **5 Conv 7 7 7** will display 5 cu CM).

MILLIMETERS

Conv 9 9 — **Square Millimeters**

(e.g., **5 Conv 9 9** will display 5 sq MM).

Conv 9 9 9 — **Cubic Millimeters**

(e.g., **5 Conv 9 9 9** will display 5 cu MM).

SETTING FRACTIONAL RESOLUTION

The *Construction Master Pro* is set to display fractional answers in 16ths of an Inch. All examples in this User's Guide are based on 1/16". However, you may select the fractional resolution to be displayed in other formats (e.g., 1/64", 1/32", etc.). The method for permanently changing fractional resolution is shown below.

Setting Fractional Resolution — Using the Preference Setting Mode

KEYSTROKE

DISPLAY

1. Access Preference Settings:

Conv **Stor** (Prefs)

FRAC 0-1/16 INCH*

2. Access Next Fraction Subsetting:

+

FRAC 0-1/32 INCH

+

FRAC 0-1/64 INCH

+

FRAC 0-1/2 INCH

+

FRAC 0-1/4 INCH

+

FRAC 0-1/8 INCH

+ (repeats options)

FRAC 0-1/16 INCH

3. To Permanently Set the Fractional Resolution You Have Selected Above, press **On/C** (or any key) to set the displayed Fractional Resolution and Exit Preference Settings.

On/C

0.

4. To Recall Your Selected Fractional Resolution:

Rcl **✓**

STD 0-1/16 INCH

*1/16" is the default setting. The display may differ from the example depending on what the resolution is currently set to.

Converting a Fractional Value to a Different Resolution

Add 44/64th to 1/64th of an Inch and then convert the answer to other fractional resolutions:

KEYSTROKE	DISPLAY
On/C On/C	0.
4 4 / 6 4	0-44/64 INCH
+ 1 / 6 4 =	0-45/64 INCH
Conv 1 (1/16)	0-11/16 INCH
Conv 2 (1/2)	0-1/2 INCH
Conv 3 (1/32)	0-23/32 INCH
Conv 4 (1/4)	0-3/4 INCH
Conv 6 (1/64)	0-45/64 INCH
Conv 8 (1/8)	0-3/4 INCH
On/C On/C *	0.

* Changing the Fractional Resolution on a displayed value does not alter your Permanent Fractional Resolution Setting (set via Preference Settings).

Note: This setting is temporary; it will revert back to your permanent fractional setting upon press of **On/C**, or when you turn the calculator off.

CONVERSIONS (LINEAR, AREA, VOLUME)

Linear Conversions

Convert 14 Feet to other dimensions:

KEYSTROKE	DISPLAY
On/C On/C	0.
1 4 Feet	14 FEET
Conv Yds	4.666667 YD
Conv Feet	14 FEET 0 INCH
Conv Inch	168 INCH
Conv m	4.267 M
Conv 7 (cm)	426.72 CM
Conv 9 (mm)	4267.2 MM

*Note: When performing multiple conversions, you only have to press the **Conv** key once except when accessing secondary functions, such as **Conv** **7** for Centimeters.*

Converting Feet-Inch-Fractions to Decimal Feet

Convert 15 Feet 9-1/2 Inches to Decimal Feet. Then convert back to Feet-Inch-Fractions.

KEYSTROKE	DISPLAY
On/C On/C	0.
1 5 Feet 9 Inch 1 / 2	15 FEET 9-1/2 INCH
Conv Feet	15.79167 FEET
Feet *	15 FEET 9-1/2 INCH

Converting Decimal Feet to Feet-Inch-Fractions

Convert 17.32 Feet to Feet-Inch-Fractions.

KEYSTROKE	DISPLAY
On/C On/C	0.
1 7 . 3 2 Feet	17.32 FEET
Conv Feet	17 FEET 3-13/16 INCH
Feet *	17.32 FEET

* Repeated presses of **Feet** or **Inch** will toggle between Feet-Inch-Fractions and Decimal Feet or Inches.

Converting Fractional Inches to Decimal Inches

Convert 8-1/8 Inches to Decimal Inches. Then convert to Decimal Feet.

KEYSTROKE	DISPLAY
On/C On/C	0.
8 Inch 1 / 8	8-1/8 INCH
Conv Inch	8.125 INCH
Feet	0.677083 FEET
Inch *	8.125 INCH

Converting Decimal Inches to Fractional Inches

Convert 9.0625 Inches to Fractional Inches. Then convert to Decimal Feet.

KEYSTROKE	DISPLAY
On/C On/C	0.
9 . 0 6 2 5 Inch	9.0625 INCH
Conv Inch	9-1/16 INCH
Feet Feet *	0.755208 FEET

*Repeated presses of **Feet** or **Inch** will toggle between Feet-Inch-Fractions and Decimal Feet or Inches.

Square Conversions

Convert 14 Square Feet to other Square dimensions:

KEYSTROKE	DISPLAY
On/C On/C	0.
1 4 Feet Feet	14 SQ FEET
Conv Inch	2016. SQ INCH
Conv Yds	1.555556 SQ YD
Conv m	1.300643 SQ M
Conv 7 (cm)	13006.43 SQ CM

Cubic Conversions

Convert 14 Cubic Feet to other Cubic dimensions:

KEYSTROKE	DISPLAY
On/C On/C	0.
1 4 Feet Feet Feet	14 CU FEET
Conv Inch	24192. CU INCH
Conv Yds	0.518519 CU YD
Conv m	0.396436 CU M

PERFORMING BASIC MATH WITH DIMENSIONS

Adding Dimensions

KEYSTROKE

DISPLAY

Add 11 Inches to 2 Feet 1 Inch:

1 1 Inch + 2 Feet 1 Inch =

3 FEET 0 INCH

Add 5 Feet 7-1/2 Inches to 18 Feet 8 Inches:

5 Feet 7 Inch 1 / 2 + 1 8 Feet 8 Inch =

24 FEET 3-1/2 INCH

Subtracting Dimensions

KEYSTROKE

DISPLAY

Subtract 3 Feet from 11 Feet 7-1/2 Inches:

1 1 Feet 7 Inch 1 / 2 - 3 Feet =

8 FEET 7-1/2 INCH

Subtract 32 Inches from 81 Inches:

8 1 Inch - 3 2 Inch =

49 INCH

Multiplying Dimensions

KEYSTROKE

DISPLAY

Multiply 5 Feet 3 Inches by 11 Feet 6-1/2 Inches:

5 Feet 3 Inch X 1 1 Feet 6 Inch 1 / 2 =

60.59375 SQ FEET

Multiply 2 Feet 7 Inches by 10:

2 Feet 7 Inch X 1 0 =

25 FEET 10 INCH

Dividing Dimensions

KEYSTROKE

DISPLAY

Divide 30 Feet 4 Inches by 7 Inches:

3 0 Feet 4 Inch ÷ 7 Inch =

52.

Divide 20 Feet 3 Inches by 9:

2 0 Feet 3 Inch ÷ 9 =

2 FEET 3 INCH

Percentage Calculations

The percent **%** key is used to find a given percent of a number or to perform add-on, discount or division percentage calculations. You may also perform percentage calculations with dimensional units (Feet, Inch, etc.), in any format (linear, Square or Cubic).

Examples:

KEYSTROKE	DISPLAY
Find 18% of 500 Feet: 5 0 0 Feet × 1 8 %	90 FEET 0 INCH
Add 10% to 137 Square Feet: 1 3 7 Feet Feet + 1 0 %	150.7 SQ FEET
Subtract 20% from 552 Feet 6 Inches: 5 5 2 Feet 6 Inch - 2 0 %	442 FEET 0 INCH
Divide 350 Cubic Yards by 80%: 3 5 0 Yds Yds Yds ÷ 8 0 %	437.5 CU YD

MEMORY OPERATION

Your calculator has two types of Memory operations:

- 1) a standard, cumulative, semi-permanent Memory **M+**; and
- 2) three storage registers **M1**, **M2**, and **M3**, used to permanently store single, non-cumulative values.

Memory commands are listed below.

FUNCTION	KEYSTROKES
M+ :	
Add value to M+	M+
Subtract value from M+	Conv M+
Clear M+	Conv Rcl
Display and Clear M+	Rcl Rcl
Recall stored value	Rcl M+
M1/M2/M3:	
Store single value in M1	Stor 1
Store single value in M2	Stor 2
Store single value in M3	Stor 3
Clear register M1	0 Stor 1

(Cont'd)

(Cont'd)

FUNCTION	KEYSTROKES
Clear register M2	0 Stor 2
Clear register M3	0 Stor 3
Recall stored value in M1	Rcl 1
Recall stored value in M2	Rcl 2
Recall stored value in M3	Rcl 3

Basic Cumulative Memory (M+)

Example:

Store 100 into M+, add 200, and then subtract 50. Display the total, average, and total count. Clear the Memory:

KEYSTROKE	DISPLAY
1 0 0 M+	M+ 100. M
2 0 0 M+	M+ 200. M
5 0 Conv M+ (M-)	M- 50. M
Rcl M+	TTL STORED 250. M
M+	AVG 83.33333 M
M+	CNT 3. M
Rcl Rcl	M+ 250.

Note: To Clear Memory (M+):

- press **Rcl** **Rcl**;
- **Conv** **Rcl**; or
- turn off the calculator.

Permanent Storage Registers (M1 and M2)

Examples:

Store a rate of \$175 into M1 and recall the value:

KEYSTROKE	DISPLAY
1 7 5 Stor 1	M-1 STORED 175.
Off On/C	0.
Rcl 1	M-1 STORED 175.

Store 1,575 Square Yards into M2 and recall the value:

KEYSTROKE	DISPLAY
1 5 7 5 Yds Yds Stor 2	M-2 STORED 1575. SQ YD
Off On/C	0.
Rcl 2	M-2 STORED 1575. SQ YD

Note: To Clear M1-M3: Values stored in M1-M3 will remain permanently stored, even after you turn the calculator off. You will never need to clear the storage registers; simply enter a new value. However, if you wish to clear M1-M3 to "zero":

- Enter **0** **Stor** **1**, **0** **Stor** **2**, or **0** **Stor** **3** or **Conv** **X** to clear all registers

PAPERLESS TAPE OPERATION

Note: Not available on DT (Desktop) Printer — Model #44065.

The Paperless Tape allows you to display and review the last twenty entries of a regular math or basic dimensional math string calculation.

To access this mode after entering values, press **Rcl** **=**. Then, press **+** or **=** to scroll forward or backward through the entries.

While in the Paperless Tape mode, the display will show the previously entered or calculated value, along with the sequential number of entry (e.g., 01, 02, 03, etc.) and the math operator (+, -, x, ÷, %) in the upper left corner of the display.

*Note: If **=** has been used in the middle of a string, SUB (for Subtotal) will display in the upper left. If **=** was the last operation performed, the display will show TTL (Total) as the last entry.*

To **exit** this mode, press **=** to exit and maintain the last entry on the display. When exiting, the last entry (or TTL) will be displayed, allowing you to continue using the last tape value for another operation, if desired.

Note: The Paperless Tape is cleared when:

- **On/C** is pressed twice;
- upon a new calculation (new equation string is started); or
- when the calculator is shut off.

Example:

KEYSTROKE	DISPLAY
-----------	---------

1. Enter a string of numbers:

4 Feet +	4 FEET 0 INCH
5 Feet +	9 FEET 0 INCH
6 Feet +	15 FEET 0 INCH
7 Feet =	22 FEET 0 INCH

2. Access the tape function:

Rcl =	TTL= 22 FEET 0 INCH
---------------------	---------------------

3. Scroll from first value to total:

+	01 4 FEET 0 INCH
+	02+ 5 FEET 0 INCH
+	03+ 6 FEET 0 INCH
+	04+ 7 FEET 0 INCH
+	TTL = 22 FEET 0 INCH

(Cont'd)

(Cont'd)

KEYSTROKE

DISPLAY

4. Scroll last two values:



04+ 7 FEET 0 INCH

03+ 6 FEET 0 INCH

5. Exit tape function and continue:



TTL= 22 FEET 0 INCH

22 FEET 0 INCH

24 FEET 0 INCH

EXAMPLES — USING THE CONSTRUCTION MASTER PRO

The *Construction Master Pro* calculators have keys and functions labeled in common building terms. Just follow the examples and adapt the keystrokes to your specific application.

Please note that some of the following examples will not apply to your specific calculator model. For example, the *Trig Model* (#4080) has trigonometry functions, but does not have **Length**, **Width** or **Height** keys, or *Blocks*, *Footing* or *Drywall* functions.

It is good practice to clear your calculator (press **On/C** twice) before beginning each problem. And remember to use the Backspace  key to correct entries one entry at a time.

LINEAR MEASUREMENT EXAMPLES

Adding Linear Measurements

Find the total length of the following measurements: 5 Feet 4-1/2 Inches, 8 Inches and 3.5 Yards.

KEYSTROKE	DISPLAY
1. Add the measurements:	
On/C On/C	0.
5 Feet 4 Inch 1 / 2 +	5 FEET 4-1/2 INCH
8 Inch +	6 FEET 0-1/2 INCH
3 . 5 Yds	3.5 YD
2. Find the total:	
=	16 FEET 6-1/2 INCH

Cutting Boards

How many 2-foot 2-inch pieces can be cut from one 10-foot board?

KEYSTROKE	DISPLAY
Divide board length by smaller cuts:	
On/C On/C	0.
1 0 Feet	10 FEET
÷ 2 Feet 2 Inch =	4.615385 (4 whole pieces)

Window Measurement

What is the total width of three window openings, if each measures 2 Feet 5 Inches in width?

KEYSTROKE

DISPLAY

1. Enter window width:

On/C **On/C**

0.

2 **Feet** **5** **Inch**

2 FEET 5 INCH

2. Find total width:

× **3** **=**

7 FEET 3 INCH

3. Convert to Decimal Feet:

Feet

7.25 FEET

Calculating the Center Point

You have a room that measures 13 Feet 8 Inches by 14 Feet 10 Inches. Find the center point to install a ceiling fan.

KEYSTROKE

DISPLAY

1. Divide length in half, to figure first center point:

On/C **On/C**

0.

1 **3** **Feet** **8** **Inch**

13 FEET 8 INCH

÷ **2** **=**

6 FEET 10 INCH

2. Divide width in half, to figure second center point:

1 **4** **Feet** **1** **0** **Inch**

14 FEET 10 INCH

÷ **2** **=**

7 FEET 5 INCH

Therefore, you should install the fan at the intersection of 6 Feet 10 Inches length and 7 Feet 5 Inches width.

AREA CALCULATIONS

Square Area (x^2)

What is the area of a square room with sides measuring 7 Feet 4 Inches?

KEYSTROKE

DISPLAY

On/C **On/C**

0.

7 **Feet** **4** **Inch** **Conv** **%** (x^2)

53.77778 SQ FEET

Area of a Rectangular Room (LxW)

What is the area of a room measuring 12 Feet 6 Inches by 15 Feet 8 Inches?

KEYSTROKE

DISPLAY

On/C **On/C**

0.

1 **2** **Feet** **6** **Inch**

12 FEET 6 INCH

X **1** **5** **Feet** **8** **Inch** **=**

195.8333 SQ FEET

*Note: You can also find area using the **Length** and **Width** keys as seen in the next problem. However, these keys are not available on the Trig Model (#4080).*

Using Multi-Function **Width** Key to Find Area, Square-up and Perimeter (NOT AVAILABLE ON TRIG MODEL #4080)

Find the area, square-up and perimeter of a space measuring 20 Feet 6 Inches by 25 Feet 6 Inches:

KEYSTROKE

DISPLAY

On/C **On/C**

0.

2 **0** **Feet** **6** **Inch** **Length**

LNTH 20 FEET 6 INCH

2 **5** **Feet** **6** **Inch** **Width**

WDTH 25 FEET 6 INCH

Width

AREA 522.75 SQ FEET

Width

SQUP 32 FEET 8-5/8 INCH

Width

PER 92 FEET 0 INCH

VOLUME CALCULATIONS

Rectangular Containers (LxWxH)

What is the volume of a rectangular container that measures 3 Feet by 1 Foot 9-5/8 Inches by 2 Feet 4 Inches?

KEYSTROKE

DISPLAY

1. Find volume in Cubic Feet:

On/C **On/C**

0.

3 **Feet**

3 FEET

X **1** **Feet** **9** **Inch** **5** **/** **8**

1 FEET 9-5/8 INCH

X **2** **Feet** **4** **Inch** **=**

12.61458 CU FEET*

2. Convert to Cubic Yards:

Conv **Yds**

0.467207 CU YD

**If the "Volume Display Format" Preference Setting is set to Cubic Yards or Cubic Meters, your result will display accordingly. (See Preference Settings on page 83.)*

Using the Multi-Function **Height** Key to Find Volume, Wall Area and Room Area (NOT AVAILABLE ON TRIG MODEL #4080)

Find the volume, wall area and total surface/room area* if you have a length of 15 feet, width of 20 feet and height of 12 feet.

**Room Area includes four walls plus ceiling area.*

KEYSTROKE

DISPLAY

On/C **On/C**

0.

1 **5** **Feet** **Length**

LNTH 15 FEET 0 INCH

2 **0** **Feet** **Width**

WDTH 20 FEET 0 INCH

1 **2** **Feet** **Height**

HGHT 12 FEET 0 INCH

Height

VOL 3600. CU FEET

Height

WALL 840. SQ FEET

Height

ROOM 1140. SQ FEET

Volume of a Cylinder

Calculate the volume of a cylinder with a diameter of 2 Feet 4 Inches and a height of 4 Feet 6 Inches:

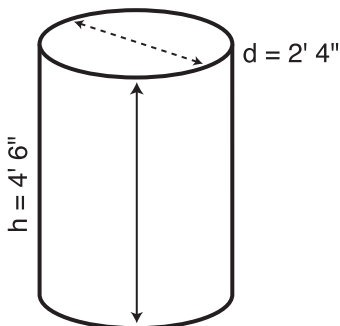

Note: For a cylinder, use the Column function.

KEYSTROKE

DISPLAY

1. Find Circle area:

On/C **On/C**

2 **Feet** **4** **Inch**

Circ **Circ**

0.

2 FEET 4 INCH

AREA 4.276057 SQ FEET

2. Enter height and find volume:

4 **Feet** **6** **Inch** **Height**

Conv **Circ**

HGHT 4 FEET 6 INCH

COL 19.24226 CU FEET

Volume of a Cone

Calculate the volume of a Cone with a diameter of 3 Feet 6 Inches and a height of 5 Feet:

KEYSTROKE

DISPLAY

1. Find Circle area:

On/C **On/C**

3 **Feet** **6** **Inch** **Circ**

Circ

0.

DIA 3 FEET 6 INCH

AREA 9.621128 SQ FEET

2. Enter height and find volume:

5 **Feet** **Height**

Conv **Circ** **Circ** **Circ***

HGHT 5 FEET 0 INCH

CONE 16.03521 CU FEET

*To access Cone volume, you must press the **Circ** key three times after **Conv**.

For Trig Model (#4080) Users:

As this model does not have a **Height** key, you must enter the height using the **Rise** key.

WEIGHT/VOLUME CONVERSIONS

Weight Conversions

Convert 2,500 Pounds to Kilograms, Tons and Metric Tons:

KEYSTROKE DISPLAY

1. Enter Pounds:

On/C **On/C** 0.
2 **5** **0** **0** **Conv** **4** (lbs) 2500 LB

2. Convert to Kilograms, Tons and Metric Tons:

Conv **1** (kg) 1133.981 kg
Conv **6** (tons) 1.25 Ton
Conv **3** (met tons) 1.133981 MET Ton

Weight per Volume/Volume Conversions

Convert 5 Cubic Yards of concrete to Pounds, Tons and Kilograms, if concrete weighs 1.5 Tons per Cubic Yard.

KEYSTROKE DISPLAY

1. Store Weight per Volume:

On/C **On/C** 0.
1 **▢** **5** **Stor** **0*** (wt/vol) **STORED** 1.5 Ton Per CU YD

2. Enter concrete volume:

5 **Yds** **Yds** **Yds** 5 CU YD

3. Convert to Pounds, Tons and Kilograms:

Conv **4** (lbs) 15000. LB
Conv **6** (tons) 7.5 Ton
Conv **1** (kg) 6803.886 kg

*If calculator does not display Tons per Cubic Yard, keep pressing the **0** key until the desired format is displayed (e.g., Ton Per CU YD, LB Per CU YD, LB Per CU FEET, MET Ton Per CU M, or kg Per CU M).

BLOCKS/BRICKS (NOT AVAILABLE ON TRIG MODEL #4080)

Number of Blocks, Based on Entered Length and Height

You are building an “L” shaped retaining wall out of standard 8-inch x 16-inch size blocks (*Note: this is the default block size of 128 Square Inches*). One side of the retaining wall is 22 Feet long, and the other side is 15 Feet 8 Inches long. The wall is to be 4 Feet high. How many blocks are required to build this wall? Add a 5% waste allowance.

Note: The calculated area from an entered length (Length) and height (Height) will be used for calculating blocks if these values exist.

KEYSTROKE

DISPLAY

1. Find total wall length:

On/C On/C **0.**
Rcl Conv 4* (Blk Size) **B--AR STORED 128. SQ INCH**
2 2 Feet + 1 5 Feet 8 Inch = **37 FEET 8 INCH**
Length **LNTH 37 FEET 8 INCH**

2. Enter wall height as height:

4 Feet Height **HGHT 4 FEET 0 INCH**

3. Find the number of blocks and add 5% waste allowance:

Conv Length (Blocks) **BLKS 169.5**
+ 5 % **177.975**
(178 Blocks)

*If **Rcl Conv Length (Blocks)** does not result in 128 Square Inches, then enter the following:

1 2 8 Inch Inch Stor 4 (Blk Size) **B--AR STORED 128. SQ INCH**

-OR-

8 Inch X 1 6 Inch = **128. SQ INCH**

Stor 4 (Blk Size) **B--AR STORED 128. SQ INCH**

Number of Blocks, Based on Entered Area

Find the number of blocks required for an area measuring 300 Square Feet. Then add a 3% waste allowance.

KEYSTROKE

DISPLAY

On/C On/C **0.**
3 0 0 Feet Feet **300 SQ FEET**
Conv Length (Blocks) **BLKS 337.5**
+ 3 % **347.625**
(348 Blocks)

Number of Blocks, Based on Calculated Perimeter

Calculate the wall's perimeter if the length is 30 Feet and width is 45 Feet. Then, find the number of blocks required. Add a 3% waste allowance.

KEYSTROKE

DISPLAY

1. Find wall area:

On/C **On/C**

3 **0** **Feet** **Length**

4 **5** **Feet** **Width**

0.

LNTH 30 FEET 0 INCH

WDTH 45 FEET 0 INCH

2. Find the perimeter:

Width **Width** **Width**

PER 150 FEET 0 INCH

3. Find the number of blocks for the displayed perimeter, and add 3% waste allowance:

= **Conv** **Length** (Blocks)

+ **3** **%**

BLKS 112.50

115.875

(116 Blocks)

Number of Blocks, Based on Entered Length

Calculate the number of blocks required for a length of 20 Feet.

KEYSTROKE

DISPLAY

1. Enter length then calculate number of blocks:

On/C **On/C**

2 **0** **Feet**

Conv **Length** (Blocks)

0.

20 FEET

BLKS 15.

2. Display the stored block length*:

Length

B-LN STORED 16 INCH

Note: The calculator will calculate the number of blocks based on the entered length and the stored block size (length).

**If the stored block length is not 16 Inches, then enter the following:*

1 **6** **Inch** **Stor** **4** (Blk Size)

B-LN STORED 16 INCH

Number of “Face” Bricks

How many “face” bricks (21 Square Inch size) will you need to purchase to cover a 40-Foot by 8-Foot wall, if you include a 3% waste allowance? Use the Blocks function for calculating bricks.

KEYSTROKE

DISPLAY

1. Enter and store brick area into Block Size storage key:
On/C On/C **0.**
2 1 Inch Inch Stor 4 (Blk Size) **B--AR STORED 21. SQ INCH**
2. Enter length and height of wall:
4 0 Feet Length **LNTH 40 FEET 0 INCH**
8 Feet Height **HGHT 8 FEET 0 INCH**
3. Find the number of bricks and add a 3% waste allowance:
Conv Length (Blocks) **BLKS 2194.286**
+ 3 % **2260.114**
(2261 Bricks)
4. Reset block area to default value:
1 2 8 Inch Inch Stor 4 (Blk Size) **B--AR STORED 128. SQ INCH**

Number of “Paver” Bricks

How many “paver” bricks (32 Square Inch size) will you need to fill a 5-Foot by 15-Foot walkway?

KEYSTROKE

DISPLAY

1. Enter brick area into Block Size storage key:
On/C On/C **0.**
3 2 Inch Inch Stor 4 (Blk Size) **B--AR STORED 32. SQ INCH**
2. Enter length and width (as height):
5 Feet Length **LNTH 5 FEET 0 INCH**
1 5 Feet Height **HGHT 15 FEET 0 INCH**
3. Find the number of bricks:
Conv Length (Blocks) **BLKS 337.5**
(338 Bricks)
4. Reset block area to default value:
1 2 8 Inch Inch Stor 4 (Blk Size) **B--AR STORED 128. SQ INCH**

BOARD FEET — LUMBER ESTIMATION

The *Construction Master Pro* easily calculates board feet for lumber estimation problems. The default entry format for Board Feet is “Inch x Inch x Feet” (e.g., **2** **X** **4** **X** **1** **4** is 2 Inches x 4 Inches x 14 Feet). You can also convert Cubic values (volume) to Board Feet.

Total Board Feet — With Dollar Cost

Find the total board feet for the following board sizes:

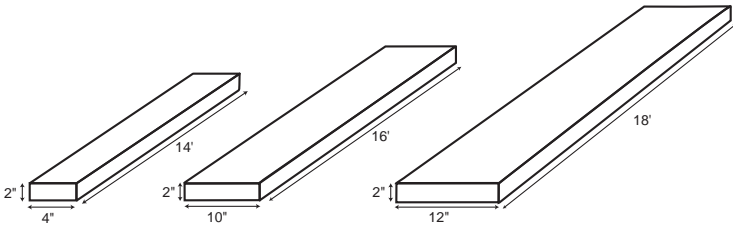

If the boards cost \$250 per MBM., what is the total cost? Use **Conv** **0** (*Cost*) to figure total lumber cost.

KEYSTROKE

DISPLAY

1. Enter board sizes, convert to board feet and store in memory:

On/C **On/C**

2 **X** **4** **X** **1** **4** **Conv** **8** **M+**

2 **X** **1** **0** **X** **1** **6** **Conv** **8** **M+**

2 **X** **1** **2** **X** **1** **8** **Conv** **8** **M+**

0.

BDFT 9.333333 M

BDFT 26.66667 M

BDFT 36. M

2. Recall total Board Feet and calculate total cost:

Rcl **Rcl**

X **2** **5** **0** **Conv** **0** (*Cost*)

BDFT 72.

\$18.00

Note: Unit cost is entered in the standard per thousand Board Foot measure (MBM) format.

Number of Board Feet Based on Entered Volume

Find the number of board feet required for a volume of 150 cubic feet.

KEYSTROKE

DISPLAY

Enter cubic feet and convert to board feet:

On/C **On/C**

1 **5** **0** **Feet** **Feet** **Feet**

Conv **8** (*Bd Ft*)

0.

150 CU FEET

BDFT 1800.

CIRCLE AND ARC CALCULATIONS

Circle/Arc values can be solved by entering any two of the following values: Arc Length/Angle, Diameter/Radius, Chord Length (Run), and Segment Rise (Rise).

It is recommended that you clear the calculator (press **On/C** twice) after calculating right-triangle solutions prior to beginning an Arc or Circle solution.

Note: Circle/Arc solutions cannot be solved for the following cases:

- Entered Arc Length and Chord Length (Run)
- Entered Arc Length and Segment Rise (Rise)

Circumference and Area of a Circle

Find the area and circumference of a circle with a diameter of 11 Inches:

KEYSTROKE	DISPLAY
On/C On/C	0.
1 1 Inch Circ	DIA 11 INCH
Circ	AREA 95.03318 SQ INCH
Circ	CIRC 34-9/16 INCH

Arc Length — Degree and Diameter Known

Find the arc length of an 85° portion of a circle with a 5-foot diameter:

KEYSTROKE	DISPLAY
On/C On/C	0.
5 Feet Circ	DIA 5 FEET 0 INCH
8 5 Arc	ARC 85.00°
Arc	ARC 3 FEET 8-1/2 INCH

Arc Length — Chord Length and Segment Rise Known

Find the arc length and radius of a circle with a 3-feet 6-inch chord length and 1-foot 3-inch segment rise.

KEYSTROKE	DISPLAY
1. Enter the chord length of the segment as Run:	
On/C On/C	0.
3 Feet 6 Inch Run	RUN 3 FEET 6 INCH
2. Enter the height of the segment as Rise:	
1 Feet 3 Inch Rise	RISE 1 FEET 3 INCH
3. Find the Radius:	
Conv Arc (Radius)	RAD 1 FEET 10-3/16 INCH

(Cont'd)

(Cont'd)

KEYSTROKE

DISPLAY

4. Find the Arc Angle:

Arc

ARC 142.15°

5. Find the Arc Length:

Arc

ARC 4 FEET 7-1/16 INCH

Arc Calculations — Arc Length and Diameter Known

Find the arc degree, chord length, segment rise, segment and pie slice area, and segment rise, given a 5-foot diameter and an arc length of 3 Feet 3 Inches:

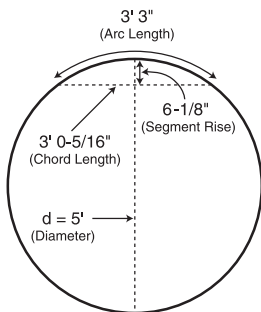

KEYSTROKE

DISPLAY

1. Enter Circle diameter (Note: enter diameter into the **Circ** key):

On/C On/C

0.

5 Feet Circ

DIA 5 FEET 0 INCH

2. Enter Arc length:

3 Feet 3 Inch Arc

ARC 3 FEET 3 INCH

3. Find degree of Arc:

Arc

ARC 74.48°

4. Find chord length:

Arc

CORD 3 FEET 0-5/16 INCH

5. Find segment area:

Arc

SEG 1.051381 SQ FEET

6. Find pie slice area:

Arc

PIE 4.0625 SQ FEET

7. Find segment rise:

Arc

RISE 0 FEET 6-1/8 INCH

ARCHED SEGMENT WALLS

The arc function can also calculate the outside (default) and inside lengths of arched walls. The outside arched wall lengths are measured outside of the arc (see diagram below). The inside arched wall lengths are measured inside of the arc (see diagram on **page 43**).

Arched Segment Walls — Arched Windows (No Base)

Find the radius of an arched window with a chord length of 8 Feet 1 Inch and a rise of 2 Feet and 10-1/2 Inches. Then, find the arc angle, arc length and segment area of the window. Then find the “outside” arched segment wall lengths in order to frame the window.

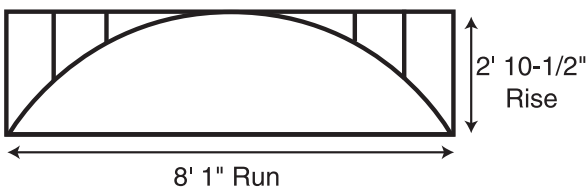

KEYSTROKE

DISPLAY

1. Enter chord length:

On/C **On/C**

8 **Feet** **1** **Inch** **Run**

0.

RUN 8 FEET 1 INCH

2. Enter rise:

2 **Feet** **1** **0** **Inch** **1** **/** **2** **Rise**

RISE 2 FEET 10-1/2 INCH

3. Find Arc angle:

Arc

ARC 141.70°

4. Find Arc length:

Arc

ARC 10 FEET 7 INCH

5. Display chord length:

Arc

CORD 8 FEET 1 INCH

6. Find segment area:

Arc

SEG 16.96327 SQ INCH

7. Find pie slice area:

Arc

PIE 22.63527 SQ INCH

(Cont'd)

(Cont'd)

KEYSTROKE

DISPLAY

8. Display entered rise (segment height):

Arc

RISE 2 FEET 10-1/2 INCH

9. Display On-center spacing:

Arc

OC STORED 16 INCH

10. Find the arched segment wall lengths:

Arc

AW 1 0 FEET 2-9/16 INCH

Arc

AW 2 0 FEET 11-3/16 INCH

Arc

AW 3 2 FEET 9-1/8 INCH

Arched Segment Walls — Arched Windows (With Base)

Find the radius of an arched window with a chord length of 8 Feet 1 Inch, a rise of 2 Feet and 10-1/2 Inches and a base height of 2 Feet. Then, find the arc angle, arc length and segment area of the window. Then find the "outside" arched segment wall lengths in order to frame the window.

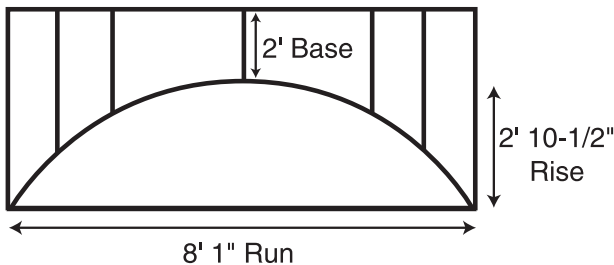

KEYSTROKE

DISPLAY

1. Enter chord length:

On/C On/C

8 Feet 1 Inch Run

0.

RUN 8 FEET 1 INCH

2. Enter rise:

2 Feet 1 0 Inch 1 / 2 Rise

RISE 2 FEET 10-1/2 INCH

3. Enter base height (into Rake Wall function):

2 Feet Conv Rise

BASE 2 FEET 0 INCH

4. Find Arc angle:

Arc

ARC 141.70°

(Cont'd)

(Cont'd)

KEYSTROKE

DISPLAY

5. Find Arc length:

Arc

ARC 10 FEET 7 INCH

6. Display chord length:

Arc

CORD 8 FEET 1 INCH

7. Find segment area:

Arc

SEG 16.96327 SQ INCH

8. Find pie slice area:

Arc

PIE 22.63527 SQ INCH

9. Display entered rise (segment height):

Arc

RISE 2 FEET 10-1/2 INCH

10. Display On-center spacing:

Arc

OC **STORED 16 INCH**

11. Find the arched segment wall lengths:

Arc

AW 1 2 FEET 2-9/16 INCH

Arc

AW 2 2 FEET 11-3/16 INCH

Arc

AW 3 4 FEET 9-1/8 INCH

Arched Segment Walls — Chord Length and Segment Height Known

You're building a circular or arched segment wall. Given a chord length of 15 Feet and a segment height of 5 Feet, find all arc values and "inside" arched segment wall lengths. The On-center spacing is 16 Inches.

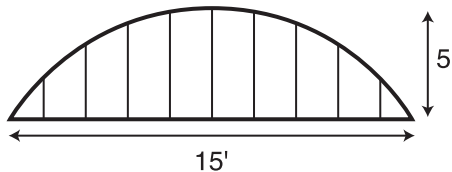

KEYSTROKE

DISPLAY

1. Change arched walls preference setting to "inside" Arc:

Conv Stor Stor Stor Stor Stor Stor

AW outSide

+

AW inSide

On/C

0.

(Cont'd)

(Cont'd)

KEYSTROKE

DISPLAY

2. Enter chord length and segment height (rise):

On/C **On/C**

0.

1 **5** **Feet** **Run**

RUN 15 FEET 0 INCH

5 **Feet** **Rise**

RISE 5 FEET 0 INCH

3. Find Arc angle:

Arc

ARC 134.76°

4. Find Arc length:

Arc

ARC 19 FEET 1-5/16 INCH

5. Display entered chord length:

Arc

CORD 15 FEET 0 INCH

6. Find segment area:

Arc

SEG 54.19722 SQ FEET

7. Find pie slice area:

Arc

PIE 77.63472 SQ FEET

8. Display entered segment height (rise):

Arc

RISE 5 FEET 0 INCH

9. Display stored On-center spacing for the wall:

Arc

OC **STORED 16 INCH**

10. Find arched segment wall lengths:

Arc

AW 1 4 FEET 10-11/16 INCH

Arc

AW 2 4 FEET 6-5/8 INCH

Arc

AW 3 3 FEET 11-3/8 INCH

Arc

AW 4 3 FEET 0-1/16 INCH

Arc*

AW 5 1 FEET 6-1/4 INCH

11. Change arched walls preference setting back to "outside" Arc:

Conv **Stor** **Stor** **Stor** **Stor** **Stor** **Stor** **Stor**

AW inSidE

+

AW outSidE

On/C

0.

*Successive presses of **Arc** will toggle to the beginning.

COMPOUND MITER

Compound Miter Cuts

You're installing crown moulding on the upper wall of your living room. If the wall corner angle is 60° and the spring (crown) angle is 38° , find the miter angle and bevel angle cut.

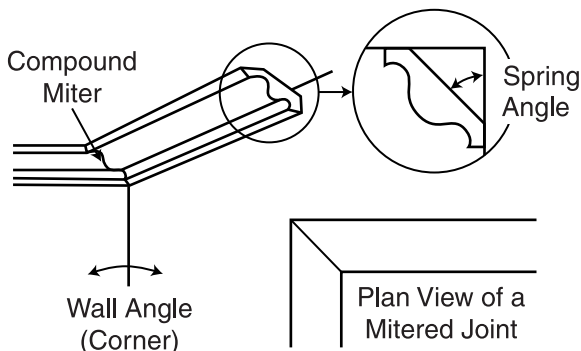

KEYSTROKE

DISPLAY

1. Store the spring angle:

On/C **On/C**

3 8 **Stor** **Comp Miter** (Spring Angle)

0.
SPRG **STORED** **38.00°**

2. Enter wall corner angle and calculate miter angle:

6 0 **Comp Miter***

MITR **46.84°**

3. Calculate bevel angle:

Comp Miter

BEVL **43.03°**

4. Display stored spring angle:

Comp Miter

SPRG **STORED** **38.00°**

5. Display entered wall corner angle:

Comp Miter

CRNR **60.00°**

*When a value less than 25 is entered as the wall corner angle, the compound miter function assumes this is the number of sides of a polygon, calculates the wall corner angle, and displays it first before displaying the miter angle.

CONCRETE/PAVING

Volume of Concrete for a Driveway

Find the Cubic Yards of concrete required to pour a driveway with the following dimensions: 36 Feet 3 Inches long by 11 Feet 6 Inches wide by 4 Inches deep. If concrete costs \$55 per Cubic Yard, what is the total cost?

KEYSTROKE

DISPLAY

1. Multiply the length times the width to find the area:

On/C **On/C**

3 **6** **Feet** **3** **Inch**

X **1** **1** **Feet** **6** **Inch**

=

0.

36 FEET 3 INCH

11 FEET 6 INCH

416.875 SQ FEET

2. Multiply times the depth to find the volume:

X **4** **Inch** **=**

5.146605 CU YD*

3. Multiply times the per Unit Cost to find the total cost of concrete:

X **5** **5** **Conv** **0** (Cost)

\$283.⁰⁶

This answer will automatically display in Cubic Yards due to the multiplication of mixed units, unless the preference setting for volume display has been changed from the default Standard Setting. (See Preference Settings on **page 83.)*

Concrete Columns

Find the Cubic Yards of concrete required to pour five columns, if each has a diameter of 3 Feet 4-1/2 Inches and a height of 11 Feet 6 Inches. If the concrete weighs 1.75 Tons per Cubic Yard, what is the total weight in Tons? In Pounds? In Kilograms?

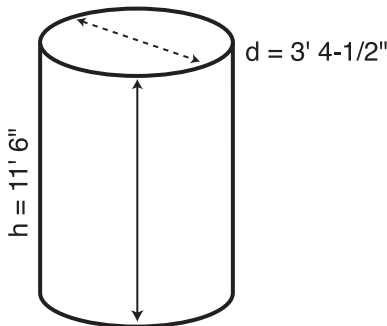

KEYSTROKE

DISPLAY

1. Enter weight in Tons per Cubic Yard:

1 **0** **7** **5** **Stor** **0** (wt/vol)

STORED 1.75 Ton Per CU YD

2. Enter diameter and find Circle area:

On/C **On/C**

3 **Feet** **4** **Inch** **1** **/** **2**

Circ **Circ**

0.

3 FEET 4-1/2 INCH

AREA 8.946176 SQ FEET

3. Enter height and find total volume of concrete:

1 **1** **Feet** **6** **Inch** **Height**

Conv **Circ** (Column/Cone)

Conv **Yds**

X **5** **=**

HGHT 11 FEET 6 INCH

COL 102.881 CU FEET

3.810408 CU YD

19.05204 CU YD

4. Convert volume to weight in tons, pounds, and kilograms:

Conv **6** (tons)

Conv **4** (lbs)

Conv **1** (kg)

33.34107 Ton

66682.14 LB

30246.51 kg

For Trig Model (#4080) Users:

As this model does not have a **Height** key, you must enter the height using the **Rise** key.

Complex Concrete Volume

You're going to pour an odd-shaped patio 4-1/2 Inches deep with the dimensions shown below. Calculate the total area (by dividing the drawing into three rectangles) and determine the total Yards of concrete required. Then, find the total cost, if concrete costs \$45 per Cubic Yard.

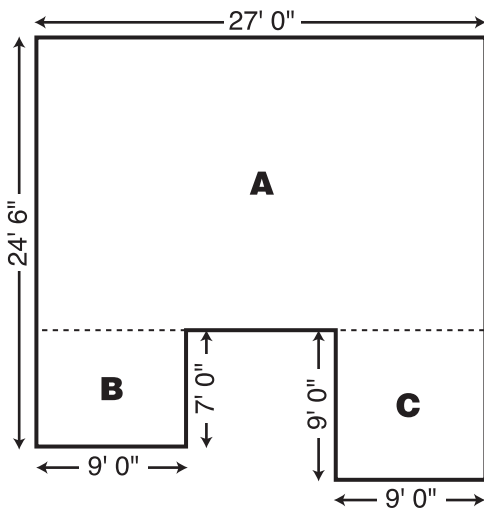

KEYSTROKE

DISPLAY

1. Find area of Part "A" and store into Memory:

On/C On/C

2 4 Feet 6 Inch =

7 Feet =

X 2 7 Feet =

M+

0.

24 FEET 6 INCH

17 FEET 6 INCH

472.5 SQ FEET

M+ 472.5 SQ FEET M

2. Find area of Part "B" and store into Memory:

7 Feet

X 9 Feet =

M+

7 FEET M

63. SQ FEET M

M+ 63. SQ FEET M

3. Find area of Part "C" and store into Memory:

9 Feet

X 9 Feet =

M+

9 FEET M

81. SQ FEET M

M+ 81. SQ FEET M

(Cont'd)

(Cont'd)

KEYSTROKE

DISPLAY

4. Find total area and clear Memory:

Rcl Rcl

M+ 616.5 SQ FEET

5. Find total Cubic Yards:

X 4 Inch 1 / 2 =

8.5625 CU YD

6. Find total cost:

X 4 5 Conv 0 (Cost)

\$385.³¹

Polygon, Finding Angles Based on Entered Radius and Number of Sides

You're going to pour a polygon-shaped patio. Find the polygon values if the radius is 15 Feet and the number of sides is 6.

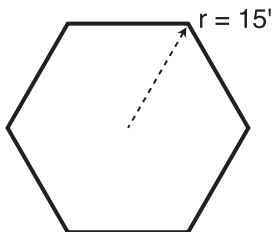

KEYSTROKE

DISPLAY

1. Enter radius and number of sides* to calculate the full angle:

On/C On/C

0.

1 5 Feet Conv Arc (Radius)

RAD 15 FEET 0 INCH

6 Conv Run (Polygon)

FULL 120.00°

2. Then calculate the bi-sect angle, side length, perimeter, and polygon area:

Run

HALF 60.00°

Run

SIDE 15 FEET 0 INCH

Run

PER 90 FEET 0 INCH

Run

AREA 584.5671 SQ FEET

*You must enter more than three sides for a multi-sided polygon figure or the calculator will display "None".

Concrete Footings (NOT AVAILABLE ON TRIG MODEL #4080)

Find the volume of concrete required for a 16-Inch by 8-Inch footing that measures 232 Feet 6 Inches in length. Then find the volume of five footings of the same size.

KEYSTROKE

DISPLAY

1. Calculate and store footing area:

On/C On/C

0.

1 6 Inch X 8 Inch = Stor 6 (Ftg Area)

F-AR STORED 128. SQ INCH

2. Enter length and find footing volume:

2 3 2 Feet 6 Inch Conv Width (Footing) FTG 7.654321 CU YD

To find the volume of multiple footings of the same size, multiply times the total number of footings:

3. Multiply by 5 footings to find total concrete volume:

X 5 =

38.2716 CU YD

4. Clear and return stored footing size to default:

Conv X

ALL CLEARed

Squaring-up a Foundation

A concrete foundation measures 45 Feet 6 Inches by 23 Feet 8 Inches. Find the diagonal measurement (square-up) to ensure the form is perfectly square.

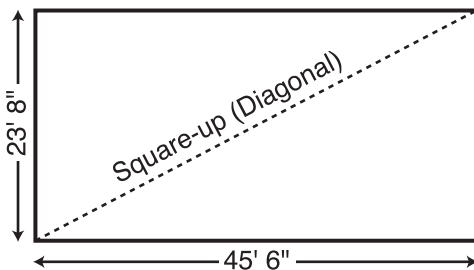

KEYSTROKE

DISPLAY

1. Enter sides as rise/run:

On/C **On/C**

2 **3** **Feet** **8** **Inch** **Rise**

4 **5** **Feet** **6** **Inch** **Run**

0.
RISE 23 FEET 8 INCH
RUN 45 FEET 6 INCH

2. Find the square-up (diagonal):

Diag

DIAG 51 FEET 3-7/16 INCH

Alternative Method using **Length** and **Width** keys (NOT AVAILABLE ON TRIG MODEL #4080):

1. Enter sides as length and width:

On/C **On/C**

2 **3** **Feet** **8** **Inch** **Length**

4 **5** **Feet** **6** **Inch** **Width**

0.
LNTH 23 FEET 8 INCH
WDTH 45 FEET 6 INCH

2. Find the square-up (diagonal):

Width **Width**

SQUP 51 FEET 3-7/16 INCH

DRYWALL (NOT AVAILABLE ON TRIG MODEL #4080)

Number of Drywall Sheets for a Given Area

Find the number of 4 x 8, 4 x 9 and 4 x 12 sheets to cover an area of 150 Square Feet.

KEYSTROKE

DISPLAY

1. Enter area:

On/C On/C **0.**
1 5 0 Feet Feet **150 SQ FEET**

2. Find the number of 4 x 8 sheets, 4 x 9 sheets and 4 x 12 sheets required:

Conv Height (Drywall) **4X8 4.6875**
(5 - 4 x 8 Sheets)

Height **4X9 4.166667**
(5 - 4 x 9 Sheets)

Height **4X12 3.125**
(4 - 4 x 12 Sheets)

Height **150. SQ FEET**

Number of Drywall Sheets for a Given Length

Find the number of 4 x 8, 4 x 9 and 4 x 12 sheets to cover a length of 40 Feet.

KEYSTROKE

DISPLAY

1. Enter length:

On/C On/C **0.**
4 0 Feet **40 FEET**

2. Find the number of 4 x 8 sheets, 4 x 9 sheets and 4 x 12 sheets required:

Conv Height (Drywall) **4X8 10.***

Height **4X9 10.***

Height **4X12 10.***

Height **LNTH 40 FEET 0 INCH**

* It is the same amount for all three of the sheet sizes because the linear calculation is based on the width of the sheets (e.g., 4 Feet).

Note: The order in which the different sheet size answers appear may differ from that of the guide. The order is based on the last displayed sheet size when previously calculated.

GRADE/SLOPE

Back-Fill on a Slope — Percent of Grade Known

You've built 55 linear Feet of a 3-foot high retaining wall that is 3 Feet from the base of a 65% grade. You need to pour back-fill within 12 Inches of the top of the wall (for a 2 Foot depth). How many Cubic Yards of fill should you have delivered?

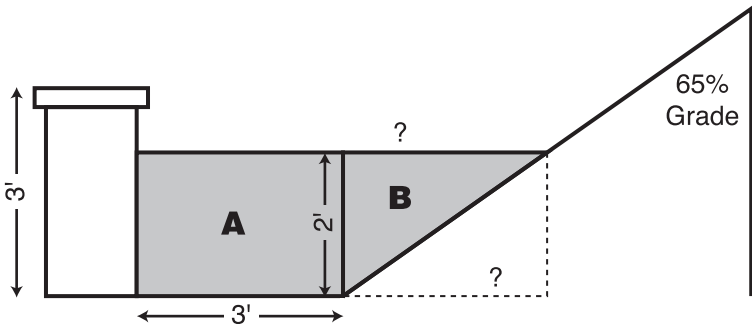

KEYSTROKE

DISPLAY

1. Find volume for "A":

On/C **On/C**

0.

5 **5** **Feet**

55 FEET

X **3** **Feet**

3 FEET

X **2** **Feet** **=** **M+**

M+ 330. CU FEET **M**

2. Find run of "B":

6 **5** **%** **Pitch**

%GRD 65. **M**

2 **Feet** **Rise**

RISE 2 FEET 0 INCH **M**

Run

RUN 3 FEET 0-15/16 INCH **M**

3. Find volume of triangle "B":

5 **5** **Feet**

55 FEET **M**

X **Rcl** **Run**

RUN 3 FEET 0-15/16 INCH **M**

X **2** **Feet** **=**

338.4615 CU FEET **M**

÷ **2** **=** **M+**

M+ 169.2308 CU FEET **M**

4. Find total volume:

Rcl **Rcl**

M+ 499.2308 CU FEET

Conv **Yds**

18.49003 CU YD

RIGHT TRIANGLE AND ROOF FRAMING EXAMPLES

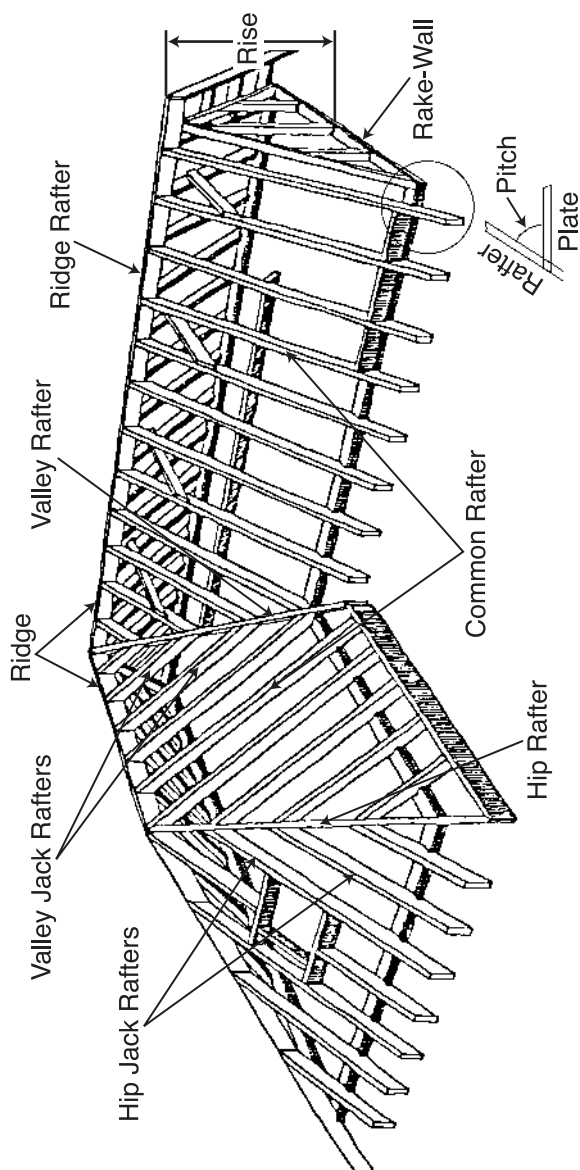

Roof Framing Definitions

Rise: The vertical distance measured from the wall's top plate to the top of the ridge.

Span: The horizontal distance or full width between the outside edges of the wall's top plates.

Run: The horizontal distance between the outside edge of the wall's top plate and the center of the ridge; in most cases this is equivalent to half of the span.

Pitch: Pitch and slope are synonymous in modern trade language. Pitch/slope of a roof is generally expressed in two types of measurement:

- 1) Ratio of unit rise to unit run* — 7/12 or 7 Inch
- 2) Angle of rafters, in degrees — 30.26°

**The unit rise is the number of Inches of rise per Foot (12 Inches) of unit run. The unit run is expressed as one Foot (12 Inches).*

Plate: The top horizontal wall member that the ceiling joist and rafters sit on and fasten to.

Ridge: The uppermost point of two roof planes. This rafter is the uppermost rafter that all Hip, Valley, Valley Jack and Common rafters are fastened to.

Rafters: Rafters are inclined roof support members. Rafters include the following types:

- **Common Rafter:** The Common connects the plate to the ridge and is perpendicular to the ridge.
- **Hip Rafter:** The Hip rafter extends from the corner of two wall plates to the ridge or King rafter at angle other than 90°. The Hip rafter is an external angle of two planes.
- **Valley Rafter:** The Valley rafter extends from the corner of two wall plates to the ridge or King rafter at angle other than 90°. The Valley rafter is an internal angle of two planes.
- **Jack Rafters:** Rafters that connect the Hip or Valley rafter to the wall plate.
- **Irregular Hip/Valley Jacks:** Jack rafters found in dual pitch or "Irregular" roofs.

Regular Roof: A standard roof where the Hips and/or Valleys run at 45° and have the same pitch/slope on both sides of the Hip and/or Valley.

Irregular Roof: A non-standard roof where the Hips and/or Valleys bisect two different pitches/slopes, or have “skewed wings” or irregular Jacks.

Rake Wall: A gable end wall that follows the pitch/slope of a roof.

Angle "A" = Angle "B"

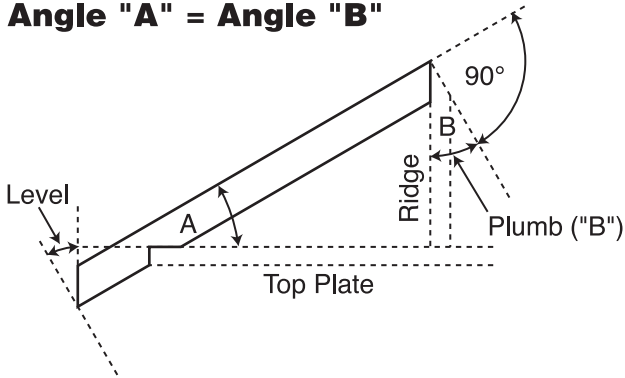

Plumb: Vertical Cut. The angle of cut from the edge of the board that allows the rafter to mate on the vertical side of the ridge rafter.

Level: Horizontal Cut. The angle of cut from the edge of the board that allows the rafter to seat flat on the wall plate.

Cheek: Side Cut(s). The angle to cut from the SIDE of the Jack rafter to match up against the Hip or Valley rafter, usually made by tilting the blade from 90° . Jack rafters typically have one Cheek cut. If there is only one pitch (no irregular pitch), the angle will be 45° . If there are two pitches, each side will have a different Cheek cut for the Jack rafter and the angles will total 90° .

Incremental Adjustment: The difference in rafter length from one rafter to the next.

Degree of Pitch

If the degree of pitch is 30.45° , what is the percent Grade, Slope and Pitch in Inches?

KEYSTROKE	DISPLAY
On/C On/C	0.
3 0 ◦ 4 5 Pitch	PTCH 30.45°
Pitch	%GRD 58.78702
Pitch	SLP 0.58787
Pitch	PTCH 7-1/16 INCH

Note: To convert Pitch in Inches: Simply enter the Pitch in Inches first (e.g., **7** **Inch** **Pitch**), then continuously press the **Pitch** key to calculate the pitch conversions, as above.

Percent Grade

If the Percent Grade is 47.25%, what is the Slope, Pitch in Inches, and Degree of Pitch?

KEYSTROKE	DISPLAY
On/C On/C	0.
4 7 ◦ 2 5 %* Pitch	%GRD 47.25
Pitch	SLP 0.4725
Pitch	PTCH 5-11/16 INCH
Pitch	PTCH 25.29°

**For entering Percent Grade, you need to label the value with the percent key.*

Pitch Ratio or Slope

If the Pitch Ratio is 0.65, what is the Pitch in Inches, Degree of Pitch, and Percent Grade?

KEYSTROKE	DISPLAY
On/C On/C	0.
◦ 6 5 Conv* Pitch (Slope)	SLP 0.65
Pitch	PTCH 7-13/16 INCH
Pitch	PTCH 33.02°
Pitch	%GRD 65.

For entering Pitch Ratio, you must press the **Conv key first.*

Common Rafter Length

If a roof has a 7/12 Pitch and a span of 14 Feet 4 Inches, what is the point-to-point length of the Common rafter (excluding the overhang or ridge adjustment)? What are the Plumb and Level cuts?

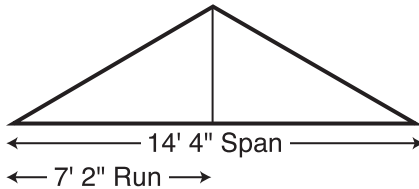

Note: Run is half the Span.

KEYSTROKE

DISPLAY

1. Find diagonal or point-to-point length of the Common rafter:

On/C On/C

7 Inch Pitch

1 4 Feet 4 Inch ÷ 2 =

Run

Diag

0.

PTCH 7 INCH

7 FEET 2 INCH

RUN 7 FEET 2 INCH

DIAG 8 FEET 3-9/16 INCH

2. Find Plumb and Level cuts:

Diag

Diag

PLMB 30.26°

LEVL 59.74°

Note: The Common rafter calculation is the "point-to-point" length and does not include the overhang or ridge adjustment.

Common Rafter Length — Pitch Unknown

Find the common rafter length for a roof with a rise of 6 Feet 11-1/2 Inches and a run of 14 Feet 6 Inches. Solve for the Pitch in Degrees and in Inches.

KEYSTROKE

DISPLAY

Find Diagonal and Pitch:

On/C On/C

6 Feet 1 1 Inch 1 / 2 Rise

1 4 Feet 6 Inch Run

Diag

Pitch

Pitch

0.

RISE 6 FEET 11-1/2 INCH

RUN 14 FEET 6 INCH

DIAG 16 FEET 1 INCH

PTCH 5-3/4 INCH

PTCH 25.64°

Angle and Diagonal (Hypotenuse)

Find the Diagonal (Hypotenuse) and degree of angle of a right triangle that is 9 Feet high and 12 Feet long.

KEYSTROKE

DISPLAY

1. Enter Rise and Run:

On/C **On/C**

0.

9 **Feet** **Rise**

RISE 9 FEET 0 INCH

1 **2** **Feet** **Run**

RUN 12 FEET 0 INCH

2. Solve for Diagonal/Hypotenuse and Pitch in Inches and Degree of Angle:

Diag

DIAG 15 FEET 0 INCH

Pitch

PTCH 9 INCH

Pitch

PTCH 36.87°

Rise

Find the Rise given a 7/12 Pitch and a Run of 11 Feet 6 Inches.

KEYSTROKE

DISPLAY

On/C **On/C**

0.

7 **Inch** **Pitch**

PTCH 7 INCH

1 **1** **Feet** **6** **Inch** **Run**

RUN 11 FEET 6 INCH

Rise

RISE 6 FEET 8-1/2 INCH

Rise and Diagonal

Find the Rise and Diagonal of a right triangle given a 30° Pitch and a run of 20 Feet 4 Inches.

KEYSTROKE

DISPLAY

On/C **On/C**

0.

3 **0** **Pitch**

PTCH 30.00°

2 **0** **Feet** **4** **Inch** **Run**

RUN 20 FEET 4 INCH

Rise

RISE 11 FEET 8-7/8 INCH

Diag

DIAG 23 FEET 5-3/4 INCH

Sheathing Cut

You have framed an equal pitch roof and need to apply the roof sheathing. Find the distance from the corner of the sheathing so that you can finish the run at the Hip rafter and cut the material. The pitch is 6 Inches and you are using 4-foot by 8-foot plywood, with the 8-foot side along the plate.

KEYSTROKE

DISPLAY

1. Enter Pitch:

On/C On/C

0.

6 Inch Pitch

PTCH 6 INCH

2. Enter width of plywood:

4 Feet Diag

DIAG 4 FEET 0 INCH

3. Find length of sheathing:

Run

RUN 3 FEET 6-15/16 INCH

Regular Hip/Valley and Jack Rafters

You're working with a 7/12 Pitch, and half your total span is 8 Feet 5 Inches:

- (1) Find point-to-point length and cut angles for the common rafter;
- (2) Find the length and cut angles of the adjoining Hip (or Valley) and;
- (3) Find the Incremental Jack Adjustment, Regular Jack Rafter lengths and cut angles (Jack Rafters at 16-Inch On-center spacing).

KEYSTROKE

DISPLAY

1. Find Common rafter length and Plumb and Level cuts:

On/C On/C

0.

8 Feet 5 Inch Run

RUN 8 FEET 5 INCH

7 Inch Pitch

PTCH 7 INCH

Diag

DIAG 9 FEET 8-15/16 INCH

Diag

PLMB 30.26°

Diag

LEVL 59.74°

2. Find Hip/Valley rafter length and cut angles:

Hip/V

H/V 12 FEET 10-1/2 INCH

Hip/V

PLMB 22.42°

Hip/V

LEVL 67.58°

Hip/V

CHK1 45.00°

(Cont'd)

(Cont'd)

KEYSTROKE

DISPLAY

3. Find regular incremental Jack adjustment and regular Jack rafter lengths and cut angles:

Jack	JKOC STORED 16 INCH*
Jack	INCR 1 FEET 6-1/2 INCH
Jack	JK 1 8 FEET 2-3/8 INCH
Jack	JK 2 6 FEET 7-7/8 INCH
Jack	JK 3 5 FEET 1-3/8 INCH
Jack	JK 4 3 FEET 6-13/16 INCH
Jack	JK 5 2 FEET 0-5/16 INCH
Jack	JK 6 0 FEET 5-13/16 INCH
Jack	JK 7 0 FEET 0 INCH
Jack	PLMB 30.26°
Jack	LEVL 59.74°
Jack	CHK1 45.00°

*If display does not read JKOC 16 INCH (the default), then reset On-center spacing by pressing **1** **6** **Inch** **Stor** **5**.

Jack Rafters — Using Other Than 16-Inch On-Center Spacing

A roof has a 9/12 Pitch and a run of 6 Feet 9 Inches. Find the incremental jack adjustment, jack rafter lengths and cut angles at 18-inch (versus 16-inch) On-center spacing. The On-center spacing is used for both Regular and Irregular Jack calculations.

KEYSTROKE

DISPLAY

1. Enter Pitch, Run and spacing:

On/C On/C	0.
9 Inch Pitch	PTCH 9 INCH
6 Feet 9 Inch Run	RUN 6 FEET 9 INCH
1 8 Inch Stor 5 (o.c.)	OC STORED 18 INCH

2. Find regular incremental Jack adjustment and regular Jack rafter lengths and cut angles:

Jack	JKOC STORED 18 INCH
Jack	INCR 1 FEET 10-1/2 INCH
Jack	JK 1 6 FEET 6-3/4 INCH
Jack	JK 2 4 FEET 8-1/4 INCH
Jack	JK 3 2 FEET 9-3/4 INCH
Jack	JK 4 0 FEET 11-1/4 INCH
Jack	JK 5 0 FEET 0 INCH
Jack	PLMB 36.87°
Jack	LEVL 53.13°
Jack	CHK1 45.00°

3. Reset On-center spacing to default 16-inch:

1 6 Inch Stor 5 (o.c.)	OC STORED 16 INCH
---	---------------------------------

Irregular Hip/Valley and Jack Rafters — *Descending, with On-Center Spacing Maintained*

You're working with a 7/12 Pitch and half your overall span is 4 Feet. The irregular Pitch is 8/12, and 16-inch On-center spacing is maintained on both sides. Complete the following steps:

- (1) Find the length of the common rafter;
- (2) Reset calculator to 16-inch On-center spacing;
- (3) Enter the Irregular Pitch; find the length of the adjoining "Irregular" Hip (or Valley) and the cut angles;
- (4) Find the incremental jack adjustment and the jack lengths on the "Irregular" Pitch side (16-inch On-center spacing);
- (5) Find the cut angles;
- (6) Find the incremental jack adjustment and the jack lengths on the "Regular" Pitch side (16-inch On-center spacing);
- (7) Find the cut angles.

KEYSTROKE

DISPLAY

1. Find Common rafter length:

On/C **On/C**

7 **Inch** **Pitch**

4 **Feet** **Run**

Diag

0.

PTCH 7 INCH

RUN 4 FEET 0 INCH

DIAG 4 FEET 7-9/16 INCH

2. Enter On-center spacing:

1 **6** **Inch** **Stor** **5** (o.c.)

OC STORED 16 INCH

3. Find Irregular Hip/Valley rafter length and cut angles:

8 **Inch** **Conv** **Hip/V** (Ir/Pitch)

IPCH 8 INCH

Hip/V

IHV 5 FEET 9-11/16 INCH

Hip/V

PLMB 23.70°

Hip/V

LEVL 66.30°

Hip/V

CHK1 41.19°

Hip/V

CHK2 48.81°

(Cont'd)

(Cont'd)

KEYSTROKE

DISPLAY

4. Find irregular incremental jack adjustment and Irregular Jack lengths:

Conv **Jack** (Ir/Jack)

Jack

Jack*

Jack

Jack

IJOC **STORED** 16 INCH
INCR 1 FEET 4-13/16 INCH
IJ 1 2 FEET 9-5/8 INCH
IJ 2 1 FEET 4-13/16 INCH
IJ 3 0 FEET 0 INCH

*It is not necessary to continue pressing **Conv** when displaying each Jack rafter size.

5. Find Irregular Jack plumb, level and cheek cut angles:

Jack

Jack

Jack

PLMB 33.69°
LEVL 56.31°
CHK1 41.19°

6. Find regular incremental jack adjustment and Regular Jack lengths:

Jack

Jack

Jack

Jack

Jack

JKOC **STORED** 16 INCH
INCR 1 FEET 9-3/16 INCH
JK 1 2 FEET 10-3/8 INCH
JK 2 1 FEET 1-1/4 INCH
JK 3 0 FEET 0 INCH

7. Find Regular Jack plumb, level and cheek cut angles:

Jack

Jack

Jack

PLMB 30.26°
LEVL 59.74°
CHK1 48.81°

Irregular Hip/Valley and Jack Rafters — Ascending, with Jacks Mating at Hip/Valley

You're working with a 7/12 Pitch and half your overall span is 4 Feet. The Irregular Pitch is 8/12, and the Jacks need to mate at the Hip. The maximum allowable On-center spacing is 16 Inches. Find the Jack rafter sizes from smallest to largest (ascending order). Complete the following steps:

- (1) Set Preference display to "JK ASCEND" (Jack sizes in ascending order);
- (2) Set Preference display to "IRJK JAC-JAC" (Jacks mate);
- (3) Find the length of the common rafter;
- (4) Find the length of the adjoining "Irregular" Hip (or Valley) and the cut angles;
- (5) Find the o.c., incremental jack adjustment, Jack lengths and cut angles on the "Irregular" pitched side;
- (6) Find the o.c., incremental jack adjustment, Jack lengths and cut angles on the "Regular" pitched side.

Note: After completing this example, you may need to reset the Preferences back to "IRJK OC-OC" if you do not normally figure jacks in this manner. (See Preference Settings on page 83.)

KEYSTROKE

DISPLAY

1. Review Preferences until you find "Jack Descend":

On/C On/C

Conv Stor (Prefs)

(If not at 1/16, press **+** until 1/16 is displayed)

Stor

Stor

Stor

Stor

Stor

Stor

Set Preference to "Ascend":

+ (plus sign)

2. Set Preference to "Jacks Mate":

Stor

+ (plus sign)

3. Find common rafter length:

7 Inch Pitch

4 Feet Run

Diag

0.

FRAC 0-1/16 INCH

AREA Std.

VOL Std.

HDRM 6 FEET 8 INCH

RAKE dESCEnd

AW outSidE

JACK dESCEnd

JACK ASCEnd

IRJK OC-OC

IRJK JAC-JAC

PTCH 7 INCH

RUN 4 FEET 0 INCH

DIAG 4 FEET 7-9/16 INCH

(Cont'd)

(Cont'd)

KEYSTROKE

DISPLAY

4. Enter Irregular Pitch and find Irregular Hip/Valley rafter length and cut angles:

8 Inch Conv Hip/V (Ir/Pitch)	IPCH 8 INCH
Hip/V	IH/V 5 FEET 9-11/16 INCH
Hip/V	PLMB 23.70°
Hip/V	LEVL 66.30°
Hip/V	CHK1 41.19°
Hip/V	CHK2 48.81°

5. Display the o.c. and find the irregular incremental jack adjustment and Irregular Jack lengths and cut angles:

Conv Jack (Ir/Jack)	IJOC STORED 16 INCH*
Jack	INCR 1 FEET 4-13/16 INCH
Jack	IJ 1 1 FEET 4-13/16 INCH
Jack	IJ 2 2 FEET 9-5/8 INCH
Jack	IJ 3 4 FEET 2-1/2 INCH
Jack	PLMB 33.69°
Jack	LEVL 56.31°
Jack	CHK1 41.19°

6. Find the o.c., regular incremental jack adjustment and Regular Jack lengths and cut angles:

Jack	JKOC 14 INCH*
Jack	INCR 1 FEET 6-1/2 INCH
Jack	JK 1 1 FEET 6-1/2 INCH
Jack	JK 2 3 FEET 1-1/16 INCH
Jack	JK 3 4 FEET 7-9/16 INCH
Jack	PLMB 30.26°
Jack	LEVL 59.74°
Jack	CHK1 48.81°

7. Reset jack rafter Preference Settings:

On/C On/C	0.
Conv Stor Stor Stor Stor Stor Stor Stor	JACK ASCEnd
Set Preference to "Descend":	
+ (plus sign)	JACK dESCEnd
Set Preference to "Jacks On-Center":	
Stor	IRJK JAC-JAC
+	IRJK OC-OC
Exit Preference Settings:	
On/C	0.

*The stored On-center spacing is used as the maximum allowable spacing. Therefore, it is assigned to the side with the largest entered pitch. In this example, the "Irregular" side pitch is larger than the "Regular" side pitch; thus, the Irregular side is calculated using the maximum On-center value (16 Inches). If the Regular pitch side had the larger pitch, it would require the larger (16 Inches) On-center.

Rake-Wall – No Base

Find each stud size in a Rake-Wall with a peak (rise) of 4 Feet, and a length (run) of 8 Feet. Use 16 Inches as your spacing.

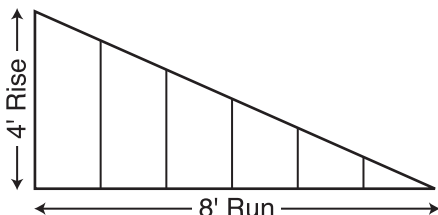

Note: The wall has no base.

KEYSTROKE

DISPLAY

1. Enter Rise and Run and display o.c. spacing:

On/C **On/C**

4 **Feet** **Rise**

8 **Feet** **Run**

Rcl **5***

0.

RISE 4 FEET 0 INCH

RUN 8 FEET 0 INCH

OC STORED 16 INCH

*If 16-inch is not displayed, enter **1** **6** **Inch** **Stor** **5**.

2. Find stud lengths:

Conv **Rise** (R/Wall)

Rise

Rise

Rise

Rise

Rise

Rise

RWOC STORED 16 INCH

RW 1 3 FEET 4 INCH

RW 2 2 FEET 8 INCH

RW 3 2 FEET 0 INCH

RW 4 1 FEET 4 INCH

RW 5 0 FEET 8 INCH

BASE 0 FEET 0 INCH

3. Find Rake-Wall angle of incline:

Rise

RW 26.57°

Note: By setting the Rake "Ascend" Preference (see Preference Settings on page 83), you may view Rake-Wall stud lengths from smallest to largest size.

*Note: You can also solve if you only know the Rise and Pitch, Run and Pitch, or Diagonal and Pitch. Simply enter the known values via **Pitch**, **Rise**, **Run**, or **Diag** keys, similar to Step #1 above, then solve for Rake-Wall stud lengths, as seen in Step #2.*

Rake-Wall – With Base

Find each stud size in a rake-wall with a peak (rise) of 4 Feet, a length (run) of 8 Feet, and a base of 5 Feet. Use 16 Inches as your On-center spacing.

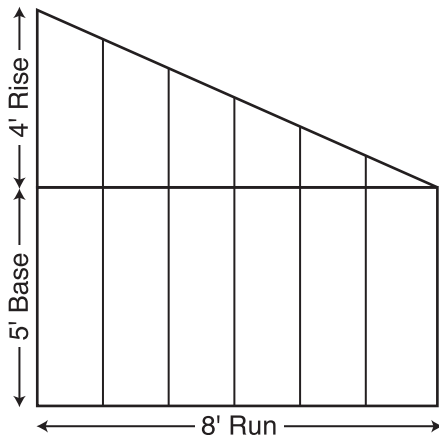

KEYSTROKE

DISPLAY

1. Enter Rise, Run, and o.c. spacing:

On/C **On/C**

4 **Feet** **Rise**

8 **Feet** **Run**

Rcl **5***

0.

RISE 4 FEET 0 INCH

RUN 8 FEET 0 INCH

OC **STORED** 16 INCH

*If 16-inch is not displayed, enter **1** **6** **Inch** **Stor** **5**.

2. Enter base, then find stud lengths and angle of incline:

5 **Feet** **Conv** **Rise** (R/Wall)

Rise

Rise

Rise

Rise

Rise

Rise

Rise

Rise

BASE 5 FEET 0 INCH

RWOC **STORED** 16 INCH

RW 1 8 FEET 4 INCH

RW 2 7 FEET 8 INCH

RW 3 7 FEET 0 INCH

RW 4 6 FEET 4 INCH

RW 5 5 FEET 8 INCH

BASE 5 FEET 0 INCH

RW 26.57°

ROOFING MATERIALS

The Roof function solves for the amount of bundles and squares for standard gable-end style roofs. Bundles are based on a coverage area of 33.33 Square Feet, and squares are based on 100 Square Feet.

Roof Covering — Entering Pitch, Length and Width

Find the roof area and number of roofing squares, number of bundles and 4 x 8 sheets required for a 10-inch Pitch roof covering a floor area of 14 Feet by 11 Feet. Also calculate the plan area.

KEYSTROKE

DISPLAY

1. Enter Pitch and floor area*:

On/C **On/C**

0.

1 **0** **Inch** **Pitch**

PTCH 10 INCH

1 **4** **Feet** **Length**

LNTH 14 FEET 0 INCH

1 **1** **Feet** **Width**

WDTH 11 FEET 0 INCH

2. Find roof area:

Conv **Diag** (Roof)

ROOF 200.4631 SQ FEET

3. Find number of roofing squares:

Diag

SQRS 2.00

4. Find number of bundles:

Diag

BNDL 6.01

5. Display bundle size/area:

Diag

B-SZ 33.33 SQ FEET

6. Find number of 4 x 8 sheets:

Diag

4X8 6.26

7. Display stored Pitch:

Diag

PTCH **STORED** 10 INCH

8. Find floor/plan area:

Diag

PLAN 154. SQ FEET

*If you know the area (and do not need to calculate it), once you have entered the Pitch, enter the area and label it as Square Feet, then press **Conv** **Diag**. For example, if the plan/floor area is 100 Square Feet, enter **1** **0** **0** **Feet** **Feet** **Conv** **Diag**.

For Trig Model (#4080) Users:

As this model does not have **Length** and **Width** keys, you must calculate area the standard way (e.g., L x W, or entering 154 Square Feet), then press **Conv** **Diag**.

Roof Covering — Entering Rise, Run (No Pitch) and Area

Find the roof covering, Pitch and plan area if the Rise is 10 feet and Run is 15 Feet. The length of the floor area is 50 Feet and the width is 30 Feet.

KEYSTROKE

DISPLAY

1. Enter Rise, Run, length and width:

On/C	On/C				0.
1 0	Feet	Rise		RISE	10 FEET 0 INCH
1 5	Feet	Run		RUN	15 FEET 0 INCH
5 0	Feet	Length		LNTH	50 FEET 0 INCH
3 0	Feet	Width		WDTH	30 FEET 0 INCH

2. Find roof area, number of roofing squares, number of bundles, stored bundle size, number of 4 x 8 sheets, Pitch and plan area:

Conv	Diag	(Roof)	ROOF	1082.776	SQ FEET
Diag				SQRS	18.03
Diag				BNDL	54.08
Diag			B-SZ	33.33	SQ FEET
Diag			4X8	56.34	
Diag			PITCH	STORED	8 INCH
Diag			PLAN	1500.	SQ FEET

For Trig Model (#4080) Users:

As this model does not have **Length** and **Width** keys, you must calculate area the standard way (e.g., $L \times W$, or entering 200 Square Feet), then press **Conv** **Diag**.

STAIR LAYOUT EXAMPLES

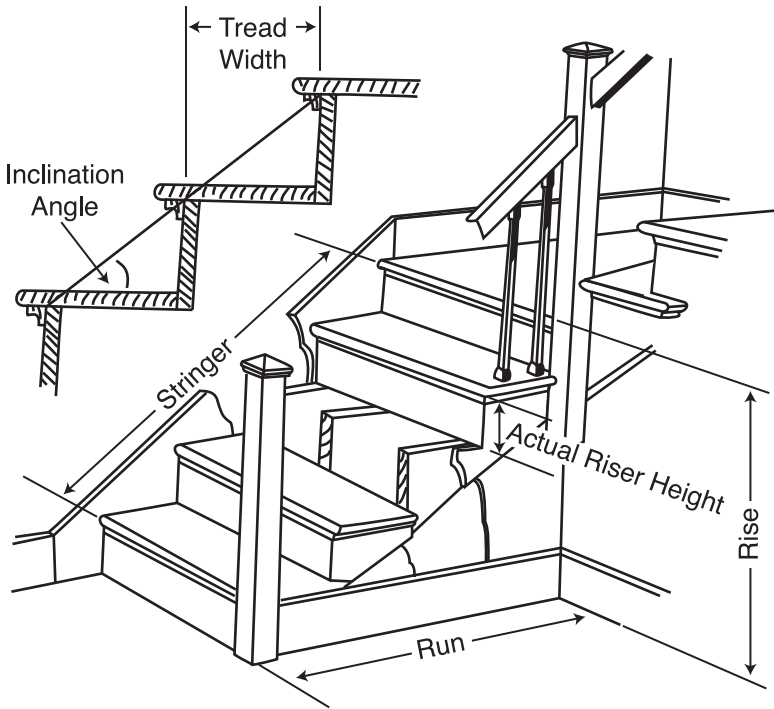

Stair Layout Definitions

Rise: The “floor-to-floor” or “landing-to-landing” rise is the actual vertical rise required for building a stairway after the finish flooring has been installed.

Run: The run of a stairway is the amount of horizontal space required. The total run of a stairway is equal to the width of each tread multiplied by the number of treads.

Desired Riser Height: The desired riser height is the amount of vertical rise you allow for each individual riser in the stairway. This is sometimes dictated by local code.

Actual Riser Height: The actual height of each riser is measured from the top of one tread to the top of the next tread.

Number of Risers: The number of risers includes both the first and the last riser of the stairway.

Riser Overage or Underage: The riser overage or underage is the difference between the “floor-to-floor” rise and the total height of all of the risers. Many times the riser height does not divide evenly into the floor-to-floor rise and a small fraction of an inch is left over. A positive remainder is an overage, while a negative remainder is an underage.

Tread Width: The width of each tread is measured from the front of one riser to the front of the next riser. The width of each tread does NOT include the nosing or overhang of the tread. The nosing or overhang of a tread is the rounded front of the tread that projects beyond the face of the riser.

Number of Treads: The number of treads is one less than the number of risers.

Tread Overage or Underage: The tread overage or underage is the difference between the run or horizontal space that a stairway must fit into and the total width of the treads. Similar to the riser overage/underage, many times the total width of the treads does not divide evenly into the run or horizontal space for the stairway and a small fraction of an inch is left over. A positive remainder is an overage, a negative remainder is an underage.

Stringers: Also called carriages, stair horses or stair jacks. Stringers are the diagonal members that support the treads and risers.

Angle of Incline: The angle of incline of the stairway is determined by the rise and run of each stair. The angle of incline should not be confused with the pitch of the stairway. The pitch of a stairway is the angle based on the floor-to-floor rise and the horizontal run of the stairway. The angle of incline is based on the “actual” riser height and the “actual” tread width of the stair.

Stairwell Opening: The length of the opening at the top of the stairs. The computation is based on the headroom height (the desired spacing between the stairs and upper floor ceiling) and thickness of the upper floor where the opening is located.

Stairs — Given Only Floor-to-Floor Rise

You're building a stairway with a total rise of 9 Feet 11 Inches. Your desired riser height is 7-1/2 Inches and desired tread width is 10 Inches. The desired headroom is 6 Feet 8 Inches and floor thickness 10 Inches*. Find all stair values, then calculate the run.

*Headroom and floor thickness are required to calculate the length of the stairwell opening.

KEYSTROKE

DISPLAY

1. Enter known Rise:

On/C **On/C**

9 **Feet** **1** **1** **Inch** **Rise**

0.

RISE 9 FEET 11 INCH

2. Recall stored desired stair riser height:

Rcl **7**

R-HT **STORED** **7-1/2 INCH**

3. Recall stored desired stair tread width:

Rcl **9**

T-WD **STORED** **10 INCH**

4. Recall stored desired floor thickness:

Rcl **8**

FLOR **STORED** **10 INCH**

5. Display stored Headroom (via Preference Setting Mode):

Conv **Stor** **Stor** **Stor** **Stor**

HDRM 6 FEET 8 INCH

6. Find riser height, number of risers, riser underage/overage, tread width, number of treads, tread overage/underage, length of stairwell opening, stringer length and angle of incline. As a final step, calculate the run.

Stair

R-HT 7-7/16 INCH

Stair

RSRS 16.

Stair

R+/- 0 INCH

Stair

T-WD **STORED** **10 INCH**

Stair

TRDS 15.

Stair

T+/- 0 INCH

Stair

OPEN 10 FEET 1 INCH

Stair

STRG 15 FEET 6-15/16 INCH

Stair

INCL 36.64°

Stair

RUN 12 FEET 6 INCH

Stair*

RISE **STORED** **9 FEET 11 INCH**

*Continuous presses of **Stair** will also recall stored desired riser height, tread, headroom and floor thickness values.

Notes on Changing Stored Stair Variables:

To Change Desired Riser Height: If you wish to use a Desired Riser Height of other than 7-1/2 Inches (the calculator's default), simply enter a new value. For example, to enter 8 Inches, enter **8** **Inch** **Stor** **7**. Press **Rcl** **7** to review your new entry. This value will be permanently stored until you change it.

To Change Desired Tread Width: If you wish to use a Desired Tread Width of other than 10 Inches (the calculator's default), simply enter a new value. For example, to enter 10-1/2 Inches, enter **1** **0** **Inch** **1** **/** **2** **Stor** **9**. Press **Rcl** **9** to review your new entry. This value will be permanently stored until you change it.

To Change Desired Floor Thickness: If you wish to use a Desired Floor Thickness of other than 10 Inches (the calculator's default), simply enter a new value. For example, to enter 12 Inches, enter **1** **2** **Inch** **Stor** **8**. Press **Rcl** **8** to review your new entry. This value will be permanently stored until you change it.

To Change Desired Headroom: If you wish to use a Desired Headroom other than 6 Feet 8 Inches (the calculator's default), simply select a new value via the Preference Mode and use the **+** or **-** keys to increase/decrease by one inch. See examples below. This value will be permanently stored until you change it.

KEYSTROKE

DISPLAY

1. *Select Headroom via Preference Mode:*

On/C **On/C**

0.

Conv **Stor** **Stor** **Stor** **Stor**

HDRM 6 FEET 8 INCH

2. *Decrease Headroom Height by 2 Inches:*

- **-**

HDRM 6 FEET 6 INCH

3. *Then increase Headroom Height by 4 Inches:*

+ **+** **+** **+**

HDRM 6 FEET 10 INCH

4. *Return Headroom Height to default of 6 Feet 8 Inches:*

- **-**

HDRM 6 FEET 8 INCH

Stairs — Given Only the Run

You're building a stairway with a total run of 20 Feet. Your desired riser height is 7-1/2 Inches and desired tread width is 10 Inches. The desired headroom is 6 Feet 8 Inches and floor thickness 10 Inches. Find all stair values, then calculate the rise.

KEYSTROKE

DISPLAY

1. Enter run:

On/C **On/C**

0.

2 **0** **Feet** **Run**

RUN 20 FEET 0 INCH

2. Find riser height, number of risers, riser underage/overage, tread width, number of treads, tread overage/underage, stairwell opening, stringer length and angle of incline. As a final step, calculate the rise.

Stair

R-HT **STORED** **7-1/2 INCH**

Stair

RSRS 25.

Stair

R+/- 0 INCH

Stair

T-WD 10 INCH

Stair

TRDS 24.

Stair

T+/- 0 INCH

Stair

OPEN 10 FEET 0 INCH

Stair

STRG 25 FEET 0 INCH

Stair

INCL 36.87°

Stair

RUN **STORED** **20 FEET 0 INCH**

Stair

RISE 15 FEET 7-1/2 INCH

Stairs — Given Rise and Run

You need to build a stairway with a floor-to-floor height of 10 Feet 1 Inch, a run of 15 Feet 5 Inches, and a nominal desired riser height of 7-1/2 Inches (default). Calculate all stair values.

KEYSTROKE

DISPLAY

1. Enter Rise and Run:

On/C **On/C**

0.

1 **0** **Feet** **1** **Inch** **Rise**

RISE 10 FEET 1 INCH

1 **5** **Feet** **5** **Inch** **Run**

RUN 15 FEET 5 INCH

2. Find Stair values:

Stair

R-HT \triangle 7-9/16 INCH*

Stair

RSRS 16.

Stair

R+/- 0 INCH

Stair

T-WD 12-5/16 INCH

Stair

TRDS 15.

Stair

T+/- - 0-5/16 INCH

Stair

OPEN 12 FEET 2-1/2 INCH

Stair

STRG 18 FEET 0-3/4 INCH

Stair

INCL 31.56°

Stair

RUN **STORED** 15 FEET 5 INCH

Stair

RISE **STORED** 10 FEET 1 INCH

Stair

R-HT **STORED** 7-1/2 INCH

Stair

T-WD **STORED** 10 INCH

Stair

HDRM **STORED** 6 FEET 8 INCH

Stair

FLOR **STORED** 10 INCH

*A \triangle in the display means that the calculated riser height exceeds the stored desired riser height.

Stairs — Given Rise and Run, Using “Riser Limited” Function for Code Restrictions

Your local code prohibits risers greater than 7-1/2 Inches. You need to build a stairway with a floor-to-floor height of 10 Feet 1 Inch, a run of 15 Feet 5 Inches. Calculate all stair values. Use the “Riser Limited” function (second function of the **Stair** key) to calculate a riser height that does not exceed the stored Desired Riser Height of 7-1/2 Inches.

KEYSTROKE

DISPLAY

1. Enter Rise and Run:

On/C On/C

0.

1 0 Feet 1 Inch Rise

RISE 10 FEET 1 INCH

1 5 Feet 5 Inch Run

RUN 15 FEET 5 INCH

2. Find stair values using “Riser Limited”:

Conv Stair (Riser Limited)

R-HT 7-1/8 INCH

Stair

RSRS 17.

Stair

R+/- 1/8 INCH

Stair

T-WD 11-9/16 INCH

Stair

TRDS 16.

Stair

T+/- 0 INCH

Stair

OPEN 12 FEET 2-1/16 INCH

Stair

STRG 18 FEET 1-5/16 INCH

Stair

INCL 31.64°

Stair

RUN **STORED** 15 FEET 5 INCH

Stair

RISE **STORED** 10 FEET 1 INCH

Stair

R-HT **STORED** 7-1/2 INCH

Stair

T-WD **STORED** 10 INCH

Stair

HDRM **STORED** 6 FEET 8 INCH

Stair

FLOR **STORED** 10 INCH

Baluster Spacing

You are going to install a handrail at the top of a balcony. Your total span is 156 Inches and you would like the space between the balusters to be about 4 Inches. If each baluster is 1-1/2 Inches wide, what is the exact spacing between each baluster?

KEYSTROKE

DISPLAY

1. Estimate number of balusters in span.

On/C **On/C**

1 **5** **6** **Inch** **÷**

5 **Inch** **1** **/** **2** **=***

0.

156 INCH

28.36364

(28 balusters)

*Desired spacing plus baluster width (4" plus 1-1/2").

2. Find total space 'occupied' by the balusters by multiplying the width of each baluster by the rounded number of balusters (found above):

1 **Inch** **1** **/** **2** **×**

2 **8** **=**

1-1/2 INCH

42 INCH

3. Find total space between all balusters:

1 **5** **6** **Inch** **=**

4 **2** **Inch** **=**

156 INCH

114 INCH

4. Find actual baluster spacing by dividing total space between all balusters by the number of spaces between the balusters (number of balusters plus one equals 29):

1 **1** **4** **Inch** **÷**

2 **9** **=**

114 INCH

3-15/16 INCH

STUDS

Find the number of 16-inch On-center studs needed for a wall with a length of 18 Feet 7-1/2 Inches.

KEYSTROKE

DISPLAY

1. Enter length and convert to Studs*.

On/C **On/C**

0.

1 **8** **Feet** **7** **Inch** **1** **/** **2**

18 FEET 7-1/2 INCH

Conv **5** (Studs)

STUD 15.

(studs)

*The length is divided by the On-center spacing; in this case, 16 Inches (default setting). Press **Rcl** **5** to review the stored On-center value. If you need to enter a new On-center, for example 18 Inches, enter **1** **8** **Inch** **Stor** **5**.

BASIC D:M:S AND TRIGONOMETRY EXAMPLES

Converting Degrees:Minutes:Seconds

Convert 23° 42' 39" to decimal degrees:

KEYSTROKE

DISPLAY

On/C **On/C**

0.

2 **3** **◦** **4** **2** **'** **3** **9** **"**

DMS 23.42.39

Conv **◦** (dms◀▶deg)

23.71°

Convert 44.29° to degrees:minutes:seconds format:

KEYSTROKE

DISPLAY

On/C **On/C**

0.

4 **4** **◦** **2** **9** **Conv** **◦** (dms◀▶deg)

DMS 44.17.24

Note: Improperly formatted entries will be redisplayed in the correct convention after any operator key is pressed. For example, 30° 89' entered will be corrected and displayed at 31° 29' 0" or 31.48333°.

Time Calculations Using D:M:S

Add 7 Hours 45 Minutes 33 Seconds to 11 Hours 16 Minutes 20 Seconds:

KEYSTROKE

DISPLAY

On/C **On/C**

0.

7 **◦** **4** **5** **◦** **3** **3**

DMS 7.45.33

+ **1** **1** **◦** **1** **6** **◦** **2** **0** **=**

DMS 19.01.53

TRIGONOMETRIC FUNCTIONS

Trigonometric functions are available on the *Construction Master Pro Trig* and *Construction Master Pro Desktop* calculators.

The drawing and formulas below list basic trigonometric formulas, for your reference:

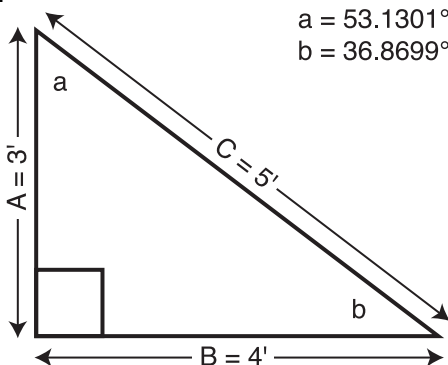

Given side A and angle a, find:

Side C	$A \div a \text{ Cos} =$
(e.g., 3 Feet \div 5 3 \cdot 1 3 Cos =)	
Side B	$A \times a \text{ Tan} =$
Angle b	$90^\circ - a =$

Given side A and angle b, find:

Side B	$A \div b \text{ Tan} =$
Side C	$A \div b \text{ Sine} =$
Angle a	$90^\circ - b =$

Given side B and angle a, find:

Side A	$B \div a \text{ Tan} =$
Side C	$B \div a \text{ Sine} =$

Given side C and angle a, find:

Side A	$C \times a \text{ Cos} =$
Side B	$C \times a \text{ Sine} =$

Given side A and side C, find:

Angle a	$A \div C = \text{Conv Cos}$
Angle b	$A \div C = \text{Conv Sine}$

Given side B and angle b, find:

Side C	$B \div b \text{ Cos} =$
Side A	$B \times b \text{ Tan} =$

Converting Percent Grade to D:M:S

You are grading a piece of property and the site plans call for an embankment with a grade “no steeper than 35%.” Your level shows the slope at an $18^\circ 15'$ angle. Will this pass?

KEYSTROKE

DISPLAY

Enter grade and convert to degrees:minutes:seconds:

On/C On/C

0.

3 5 % Conv Tan Conv \odot (dms \leftarrow \rightarrow deg)

DMS 19.17.24

Since your level reading of $18^\circ 15'$ is less steep than $19^\circ 17' 24''$, the slope will pass inspection.

Converting Tangent/Pitch to Angle

Find the angle and corresponding tangent for a roof with an 8/12 Pitch.

KEYSTROKE

DISPLAY

1. Enter pitch:

On/C On/C

0.

8 Inch Pitch

PTCH 8 INCH

2. Convert Pitch to degrees:

Pitch

PTCH 33.69°

3. Find Tangent or Slope:

Tan

0.666667

Converting Roof Angle in Degrees to Pitch in Inches

Convert a roof angle of 30.25° to Pitch in Inches.

KEYSTROKE

DISPLAY

1. Enter angle:

On/C On/C

0.

3 0 \odot 2 5 Tan

0.583183

2. Convert to Pitch:

Conv Pitch (Slope)

SLP 0.583183

Pitch

PTCH 7 INCH

Angle — Rise and Hypotenuse Known

Find the angle that connects the rise and hypotenuse of a right triangle, if the rise is 6 Feet and the hypotenuse is 10 Feet in length.

KEYSTROKE

DISPLAY

1. Use trigonometric formula (divide the rise by the hypotenuse):

On/C **On/C**

0.

6 **Feet** **÷** **1** **0** **Feet** **=**

0.6

2. Solve for degrees:minutes:seconds or angle:

Conv **Cos** (\cos^{-1})

53.13°

Conv **◻** ($dms \leftrightarrow deg$)

DMS 53.07.48

APPENDIX A — DEFAULT SETTINGS

After a *Clear All* (**Conv** **X**), your calculator will return to the following settings:

STORED VALUES	DEFAULT VALUE
Desired Riser Height	7-1/2 INCH
Desired Tread Width	10 INCH
Floor Height	10 INCH
On-center Spacing	16 INCH
Weight per Volume	1.5 Ton Per CU YD
Block Area (<i>except Trig model</i>)	128. SQ INCH
Block Length (<i>except Trig model</i>)	16 INCH
Footing Area (<i>except Trig model</i>)	264. SQ INCH
Spring (Crown) Angle	45.00°

If you replace your batteries or perform a *Full Reset** (press **Off**, hold down **X**, and press **On/C**), your calculator will return to the following settings (in addition to those listed above):

PREFERENCE SETTINGS	DEFAULT VALUE
Fractional Resolution	1/16
Area Display	Standard
Volume Display	Standard
Stairway Headroom	6 Feet 8 Inch
Rake Wall	Descending
Arched Wall	Outside
Jack Rafters	Descending
Irregular Jack Spacing	OC-OC
Exponent	Off
Meter Linear Display	0.000
Decimal Degree Display	0.00°
Fractional Mode	Standard

Depressing the Reset button located above the **Pitch key (below the **Conv** key on the Desktop model) will also perform a Full Reset.*

APPENDIX B — PREFERENCE SETTINGS

The *Construction Master Pro* calculators have Preference Settings that allow you to customize or set desired dimensional formats and calculations. The options vary per model.

If you replace your batteries or perform a *Full Reset** (press **Off**, hold down **X**, and press **On/C**), your calculator will return to the following settings (in addition to those listed on the previous page):

Depressing the Reset button located above the **Pitch key (below the **Conv** key on the Desktop model) will also perform a Full Reset.*

PREFERENCE	OPTIONS
1) Fractional Resolution	<ul style="list-style-type: none">– *1/16 (displays fractional values to the nearest 16th of an Inch)– 1/32– 1/64– 1/2– 1/4– 1/8
2) Area Display Format	<ul style="list-style-type: none">– *Standard (if units entered are the same—e.g., Feet x Feet—the answer will remain in this format (Square Feet), but if units entered are different — e.g., Inches x Feet—area answer will be displayed in Square Feet)– Square Feet (area answers always displayed in Square Feet, regardless of unit entry — e.g., Inches x Inches = Square Feet)– Square Yards (area answers always displayed in Square Yards — e.g., Feet x Feet = Square Yards)– Square Meters (area answers always displayed in Square Meters — e.g., Feet x Feet = Square Meters)

*Note: To check the current Fractional Resolution, press **Rcl** **1/16**. Either "Std" (standard fractional resolution) or "Cnst" (constant) will be displayed, along with the fractional resolution).*

(Cont'd)

(Cont'd)

PREFERENCE	OPTIONS
3) Volume Display Format	<ul style="list-style-type: none">– *Standard (if units entered are the same — e.g., Feet x Feet x Feet — the answer will remain in this format (cu. ft), but if units entered are different — e.g., Feet x Feet x Inches — vol. answer will always be displayed in Cubic Yards)– Cubic Yards (vol. answers always displayed in Cubic Yards, regardless of unit entry — e.g., Feet x Feet x Feet = Cubic Yards)– Cubic Feet (vol. answers always displayed in Cubic Feet, regardless of unit entry — e.g., Inches x Inches x Inches = Cubic Feet)– Cubic Meters (vol. answers always displayed in Cubic Meters, regardless of unit entry — e.g., Feet x Feet x Feet = Cubic Meters)
4) Stairwell—Headroom Height	<ul style="list-style-type: none">– *6 Feet 8 Inch (default)– Use + or - key to increase or decrease above value by 1 Inch
5) Rake-Wall Descending or Ascending	<ul style="list-style-type: none">– *Descending (Rake-Wall studs are displayed from largest to smallest size)– Ascending (Rake-Wall studs are displayed from smallest to largest size)
6) Arched Wall Outside or Inside	<ul style="list-style-type: none">– *Outside (Arched walls are calculated for outside of the arc)– Inside (Arched walls are calculated for inside of the arc)
7) Jack Rafters Descending or Ascending	<ul style="list-style-type: none">– *Descending (Jack rafters are displayed from largest to smallest size)– Ascending (Jack rafters are displayed from smallest to largest size)

(Cont'd)

(Cont'd)

PREFERENCE	OPTIONS
8) Irregular Jack Rafters O-C or Mate	– * OC-OC (On-center spacing maintained on both regular and irregular sides) – JAC-JAC (regular/irregular Jack rafters “mate” at the hip/valley, e.g., On-center spacing not maintained on both sides)
9) Exponent Off or On	– * Off (Exponential Mode is Off; turns on Auto-ranging; e.g., if display can't show seven digits, will display in next largest unit). – On (Exponential Mode is On)
10) Meter Linear Display	– * 0.000 (linear Meter answers are always displayed to third decimal place) – FLOAt (linear Meter answers are displayed to the maximum number of decimal places — e.g., 1.234 M + 2.56 M = 3.794 M)
11) Decimal Degree Display	– * 0.00° – FLOAt
12) Fractional Mode	– * Standard (fractions are displayed to the nearest fraction) – Constant (fractions are displayed in the set fractional resolution)

How to Set Preferences

The following sections detail Preference Setting options for the *Construction Master Pro* calculators.

Enter the Preference Mode by pressing **Conv** **Stor** (*Prefs*). Access each category by pressing the **Stor** key until you reach the desired setting. Within each category, press the **+** or **-** keys to toggle between individual selections. Press **On/C** to exit and set your Preference.

*Note: Press **+** to advance and press **-** to back up. Pressing the **Stor** key continuously in this mode will cycle through all of the Preference Settings.*

You may change these settings at any time by repeating the above, and setting in a new preference.

To reset preferences back to factory default settings, turn your calculator off, hold down the **X** key and turn the calculator back on.

For example, if you wish to display all your dimensional area answers in square meters, press **Conv** **Stor** **Stor** (*Area Std*), then the **+** key until "AREA 0. sq m" is displayed. Simply exit this mode by pressing **On/C** or any key, except **+** or **Stor**, and all your future area answers will be displayed in square meters.

Accessing Preference Settings

KEYSTROKE	DISPLAY
-----------	---------

To Set "Fractional Resolution":

Conv Stor (<i>Prefs</i>) (1st press of Stor)	FRAC 0-1/16 INCH
+ (<i>plus sign</i>)	FRAC 0-1/32 INCH
+	FRAC 0-1/64 INCH
+	FRAC 0-1/2 INCH
+	FRAC 0-1/4 INCH
+	FRAC 0-1/8 INCH
+ (<i>repeats options</i>)	FRAC 0-1/16 INCH

To Set "Area" Answer Format:

Stor (2nd press of Stor)	AREA Std.
+ (<i>plus sign</i>)	AREA 0. SQ FEET
+	AREA 0. SQ YD
+	AREA 0. SQ M
+ (<i>repeats options</i>)	AREA Std.

(Cont'd)

To Set "Volume" Answer Format:

Stor (3rd press of Stor)	VOL Std.
+ (plus sign)	VOL 0. CU YD
+	VOL 0. CU FEET
+	VOL 0. CU M
+ (repeats options)	VOL Std.

To Increase or Decrease Stairwell "Headroom" from Default of 6'8":

Stor (4th press of Stor)	HDRM 6 FEET 8 INCH
+ * (plus sign increases height by 1 Inch)	HDRM 6 FEET 9 INCH
- * (minus sign decreases height by 1 Inch)	HDRM 6 FEET 8 INCH

*Keep pressing **+** or **-** to increase or decrease an Inch at a time.

To Set Rake-Wall Stud Sizes to "Descending" or "Ascending":

Stor (5th press of Stor)	RAKE dESCend
+ (plus sign)	RAKE ASCend
+ (repeats options)	RAKE dESCend

To Set Arched Wall Calculations to "Outside" or "Inside":

Stor (6th press of Stor)	AW outSide
+ (plus sign)	AW inSide
+ (repeats options)	AW outSide

To Set Jack Rafter to "Descending" or "Ascending":

Stor (7th press of Stor)	JACK dESCend
+ (plus sign)	JACK ASCend
+ (repeats options)	JACK dESCend

To Set Irregular Jack Spacing to "On-Center" or "Mate":

Stor (8th press of Stor)	IRJK OC-OC
+ (plus sign)	IRJK JAC-JAC
+ (repeats options)	IRJK OC-OC

To Set "Exponential Mode" On or Off:

Stor (9th press of Stor)	EXP OFF
+ (plus sign)	EXP On
+ (repeats options)	EXP OFF

(Cont'd)

(Cont'd)

KEYSTROKE

DISPLAY

To Set "Meter" Linear Decimal Format:

Stor (10th press of **Stor**)

METR 0.000 M

+ (plus sign)

METR FLOAt M

+ (repeats options)

METR 0.000 M

To Set "Number of Decimal Places for Degree Displays":

Stor (11th press of **Stor**)

DEG 0.00°

+ (plus sign)

DEG FLOAt

+ (repeats options)

DEG 0.00°

To Set Fractional Mode to "Standard" or "Constant":

Stor (12th press of **Stor**)

Std.

+ (plus sign)

COnSt

+ (repeats options)

Std.

Note: Press **On/C** at any time to exit the Preference Mode.

APPENDIX C — CARE INSTRUCTIONS

Please follow the guidelines listed in this section for proper care and operation of your calculator. Not following the instructions listed below may result in damage not covered by your warranty. Refer to the Repair and Return section on **page 95** for more details.

Do not expose calculator to temperatures outside the operating temperature range of 32°F – 104°F (0°C – 40°C).

Do not expose calculator to high moisture such as submersion in water, heavy rain, etc.

APPENDIX D — IMPORTANT NOTES FOR OWNERS OF PREVIOUS CONSTRUCTION MASTERS

The Construction Master Pro Workbook and Study Guide has been written with keystroke examples, illustrations and solutions using Construction Master Pro v3.1. If you are using a Construction Master Pro v3.0 it is important to understand the changes or enhancements to the v 3.1 edition. The version number you are using appears next to the model number 4065 on the left side of the face of the calculator. You can also refer to your User's Guide for more information on any of the following functions.

NEW/ENHANCED FUNCTION	DESCRIPTION
Accumulative Memory (M+)	– Now also displays the average and the count upon repeated key presses of M+ .
Arc and Circle Calculations	– Arc and Circle values can now be solved by entering any two of the following values: Arc Length/Angle, Diameter/Radius, Chord Length, and Segment Rise.
Arched Segment Walls	– Now calculates the segment walls outside the arc (including a base, if needed), or calculates the arched segment walls inside the arc, depending upon preference setting.
Blocks Function	– Now solves for blocks based on values stored in Length only or in Length and Height .
Compound Miter	– Now calculates the Miter and Bevel angles using the spring (crown) angle (this is the angle of the crown molding to the wall; previous version 3.0 used the angle of the crown molding to the ceiling).
Column/Cone Function	– Column/Cone Height is now entered using the Height key instead of the Rise key (excludes Model #4080).
Footing Function	– Default footing area is now 264 Square Inches (instead of 1.8 Square Feet).
Height	– Displays Volume, Wall Area, and Room Area only (excludes display of Area, Square-Up, and Perimeter, which are displayed in the Width function).
Jack Rafters	– Now displays the incremental adjustment, which is the difference in rafter length from one rafter to the next.

APPENDIX E — ACCURACY/ERRORS, AUTO SHUT-OFF, BATTERIES, RESET

ACCURACY/ERRORS

Accuracy/Display Capacity — Your calculator has a twelve-digit display made up of eight digits (normal display) and four fractional digits. You may enter or calculate values up to 19,999,999.99. Each calculation is carried out internally to twelve digits.

Errors — When an incorrect entry is made, or the answer is beyond the range of the calculator, it will display the word “**ERROR**.” To clear an error condition you must hit the **On/C** button once. At this point you must determine what caused the error and re-key the problem.

Error Codes

DISPLAY	ERROR TYPE
OFLO	Overflow (too large)
MATH Error	Divide by 0
DIM Error	Dimension error
ENT Error	Invalid entry error
TRIG Error	Trig. error (for example, tan of 1 foot)
None	Attempt to calculate stairs without entering rise <i>and</i> run

Auto-Range — If an “overflow” is created because of an input and calculation with small units that are out of the standard seven-digit range of the display, the answer will be automatically expressed in the next larger units (instead of showing “**ERROR**”) — e.g., 20,000,000 mm is shown as 20,000 m. Also applies to inches, feet and yards.

Note: If Exponential Notation is activated through the Preference Setting, the value will be shown in scientific notation (e.g., 20 million mm—2.00000⁰⁷ mm).

AUTO SHUT-OFF

Your calculator is designed to shut itself off after about 8-12 minutes of non-use.

BATTERIES

- *Construction Master Pro v3.1* (#4065) and *Construction Master Pro Trig v3.1* (#4080)
Two LR-44 batteries.
- *Construction Master Pro Desktop v3.1* (#44080)
One 3-Volt Lithium CR-2032 battery.

Replacing the Battery(ies)

Should your calculator display become very dim or erratic, replace the battery(ies).

Note: Please use caution when disposing of your old battery, as it contains hazardous chemicals.

Replacement batteries are available at most discount or electronics stores. You may also call Calculated Industries at 1-775-885-4900.

Battery Replacement Instructions

- *The Hand-held Models* —
 - *Construction Master Pro v3.1* (#4065)
 - *Construction Master Pro Trig v3.1* (#4080)To replace the batteries, slide open the battery door (at top backside of unit) and replace with new batteries. Make sure the batteries are facing positive side up.
- *Construction Master Pro Desktop v3.1* (#44080):
To replace the battery, use a small Phillips' head screwdriver and unscrew the two (2) screws on the base of the unit. Carefully remove the lower back housing. Remove the battery from the clip and replace it with a new battery, with the positive side up. Then replace the backplate and reattach the screws.

RESET

If your calculator should ever “lock up,” press Reset — a small hole located above the **Pitch** key (below the **Conv** key on the *Construction Master Pro Desktop*) — to perform a total reset.



APPENDIX F — AREA/VOLUME FORMULAS

AREA FORMULAS

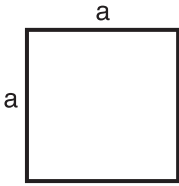

Square
Area = a^2

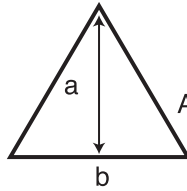

Triangle
Area = $1/2 ab$



Rectangle
Area = lw

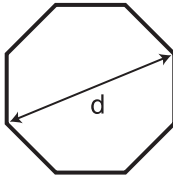

Octagon
Area = $(d/2)^2 \times 2.828$

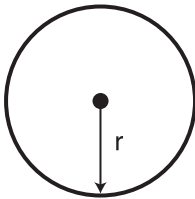

Circle
Circumference = $2\pi r$
Area = πr^2

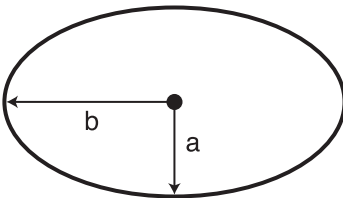

Ellipse
Area = πab

SURFACE AREA/VOLUME FORMULAS

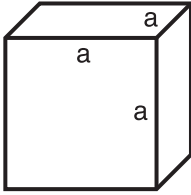

Cube

$$\text{Surface Area} = 6a^2$$

$$\text{Volume} = a^3$$

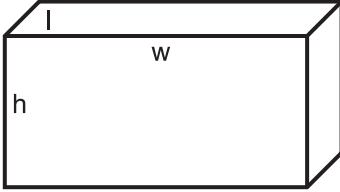

Rectangle

$$\text{Surface Area} = 2hw + 2hl + 2lw$$

$$\text{Volume} = l \times w \times h$$

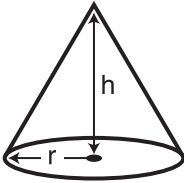

Cone

$$\text{Surface Area} = \pi r \sqrt{r^2 + h^2}$$

(+ πr^2 if you add the base)

$$\text{Volume} = \frac{\pi r^2 h}{3}$$

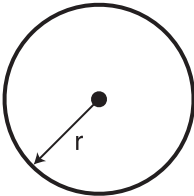

Sphere

$$\text{Surface Area} = 4\pi r^2$$

$$\text{Volume} = \frac{4}{3}\pi r^3$$

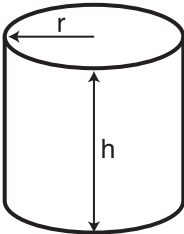

Cylinder

$$\text{Surface Area} = 2\pi r h + 2\pi r^2$$

$$\text{Volume} = \pi r^2 h$$

REPAIR AND RETURN

WARRANTY, REPAIR AND RETURN INFORMATION

Return Guidelines

1. Please read the **Warranty** in this User's Guide to determine if your Calculated Industries product remains under warranty **before** calling or returning any device for evaluation or repairs.
2. If your product won't turn on, check the batteries as outlined in the User's Guide.
3. If you need more assistance, please go to the website listed below.
4. If you believe you need to return your product, please call a Calculated Industries representative between the hours of 8:00am to 4:00pm Pacific Time for additional information and a Return Merchandise Authorization (RMA).

Call Toll Free: 1-800-854-8075

Outside USA: 1-775-885-4900

www.calculated.com/warranty

WARRANTY

Warranty Repair Service – U.S.A.

Calculated Industries (“CI”) warrants this product against defects in materials and workmanship for a period of **one (1) year from the date of original consumer purchase in the U.S.** If a defect exists during the warranty period, CI at its option will either repair (using new or remanufactured parts) or replace (with a new or remanufactured calculator) the product at no charge.

THE WARRANTY **WILL NOT APPLY** TO THE PRODUCT IF IT HAS BEEN DAMAGED BY MISUSE, ALTERATION, ACCIDENT, IMPROPER HANDLING OR OPERATION, OR IF UNAUTHORIZED REPAIRS ARE ATTEMPTED OR MADE. SOME EXAMPLES OF DAMAGES NOT COVERED BY WARRANTY INCLUDE, BUT ARE NOT LIMITED TO, BATTERY LEAKAGE, BENDING, A BLACK “INK SPOT” OR VISIBLE CRACKING OF THE LCD, WHICH ARE PRESUMED TO BE DAMAGES RESULTING FROM MISUSE OR ABUSE.

To obtain warranty service in the U.S., please go to the website.

A repaired or replacement product assumes the remaining warranty of the original product or 90 days, whichever is longer.

Non-Warranty Repair Service – U.S.A.

Non-warranty repair covers service beyond the warranty period, or service requested due to damage resulting from misuse or abuse.

Contact Calculated Industries at the number listed above to obtain current product repair information and charges. Repairs are guaranteed for 90 days.

Repair Service – Outside the U.S.A.

To obtain warranty or non-warranty repair service for goods purchased outside the U.S., contact the dealer through which you initially purchased the product. If you cannot reasonably have the product repaired in your area, you may contact CI to obtain current product repair information and charges, including freight and duties.

Disclaimer

CI MAKES NO WARRANTY OR REPRESENTATION, EITHER EXPRESS OR IMPLIED, WITH RESPECT TO THE PRODUCT'S QUALITY, PERFORMANCE, MERCHANTABILITY, OR FITNESS FOR A PARTICULAR PURPOSE. AS A RESULT, THIS PRODUCT, INCLUDING BUT NOT LIMITED TO, KEYSTROKE PROCEDURES, MATHEMATICAL ACCURACY AND PREPROGRAMMED MATERIAL, IS SOLD "AS IS," AND YOU THE PURCHASER ASSUME THE ENTIRE RISK AS TO ITS QUALITY AND PERFORMANCE.

IN NO EVENT WILL CI BE LIABLE FOR DIRECT, INDIRECT, SPECIAL, INCIDENTAL, OR CONSEQUENTIAL DAMAGES RESULTING FROM ANY DEFECT IN THE PRODUCT OR ITS DOCUMENTATION.

The warranty, disclaimer, and remedies set forth above are exclusive and replace all others, oral or written, expressed or implied. No CI dealer, agent, or employee is authorized to make any modification, extension, or addition to this warranty.

Some states do not allow the exclusion or limitation of implied warranties or liability for incidental or consequential damages, so the above limitation or exclusion may not apply to you. This warranty gives you specific rights, and you may also have other rights, which vary from state to state.

FCC Class B

This equipment has been certified to comply with the limits for a Class B calculating device, pursuant to Subpart J of Part 15 of FCC rules.

Legal Notes

Software copyrighted and licensed to Calculated Industries by Construction Master Technologies, LLC, 2005.

User's Guide copyrighted by Calculated Industries, Inc., 2005.

Construction Master® and **Calculated Industries®** are registered trademarks of Calculated Industries, Inc.

PATENT PENDING

ALL RIGHTS RESERVED

Designed in the U.S.A.

Looking For New Ideas

Calculated Industries, a leading manufacturer of special-function calculators and digital measuring instruments, is always looking for new product ideas in these areas.

If you have an idea, or a suggestion for improving this product or User's Guide, please submit your comments online at: www.calculated.com under "Contact Us", "Product Idea Submittal Agreement". Thank you.

INDEX

Accuracy/Errors, 91
Adding Linear Measurements, 29
Angle – *Rise and Hypotenuse Known*, 81
Angle and Diagonal (Hypotenuse), 59
Arc Calculations – Arc Length and Diameter Known, 40
Arc Length, 39
Arched Segment Walls, 41
Arched Windows, 41, 42
Area and Volume Keys (Not Available on Trig Model #4080), 4
Area Calculations, 31
Area, Rectangular, 31
Area, Square, 31
Area/Volume Formulas, 93
Auto Shut-Off, 91
Baluster Spacing, 77
Basic Math with Dimensions, 24
Basic Operation Keys, 1
Batteries, 92
Block/Brick Function, 6
Blocks, Number of, Based on Calculated Perimeter, 36
Blocks, Number of, Based on Entered Area, 35
Blocks, Number of, Based on Entered Length, 36
Blocks, Number of, Based on Entered Length and Height, 35
Board Feet – *With Dollar Cost*, 38
Board Feet, Number of, Based on Entered Volume, 38
Bricks (Face), Number of, 37
Bricks (Paver), Number of, 37
Center Point, Calculating, 30
Circular/Arc Function Keys, 7
Circumference and Area of a Circle, 39
Column/Cone Function, 8
Common Rafter Length, 58
Common Rafter Length – *Pitch Unknown*, 58
Compound Miter/Crown Moulding Example, 45
Compound Miter/Crown Moulding Keys, 8
Concrete (Driveway), Volume, 46
Concrete Columns, 47
Concrete Footings, 50
Concrete Volume, Complex, 48
Concrete/Paving, 46
Cone, Volume, 33
Construction Master, New Features, 90
Construction Project Keys and Functions, 6
Conversions, Area/Square, 23
Conversions, Linear, 22
Conversions, Volume/Cubic, 23
Conversions, Weight, 34
Conversions/Weight per Volume, 34
Convert **Conv** Key, 1
Convert Degree of Pitch, 57
Convert Percent Grade, 57
Converting Decimal Feet to Feet-Inch-Fractions, 22
Converting Decimal Inches to Fractional Inches, 23
Converting Degrees:Minutes:Seconds, 78
Converting Feet-Inch-Fractions to Decimal Feet, 22
Converting Fractional Inches to Decimal Inches, 23

- Converting Percent Grade to D:M:S, 80
- Converting Roof Angle in Degrees to Pitch in Inches, 80
- Converting Tangent/Pitch to Angle, 80
- Cutting Boards, 29
- Cylinder, Volume, 33
- Default Settings, 82
- Degrees:Minutes:Seconds, Converting, 78
- Dimensional Measurement Unit Keys, 3
- Dimensions (Linear), Entering, 18
- Dimensions (Square/Cubic), Entering, 18
- Dimensions, Adding, 24
- Dimensions, Dividing, 24
- Dimensions, Multiplying, 24
- Dimensions, Subtracting, 24
- Drywall, 52
- Drywall Function (Not Available on Trig Model #4080), 9
- Drywall Sheets, Number of (For a Given Area), 52
- Drywall Sheets, Number of (For a Given Length), 52
- Entering Dimensions, 18
- Error Codes, 91
- Examples, 29
- Footing Function, 9
- Grade/Slope, 53
- Hip/Valley and Jack Rafter Keys, 11
- Hip/Valley Rafter, 12
- Irregular Pitch, 12
- Irregular Side Jacks, 13
- Irregular Hip/Valley and Jack Rafters, 62, 64
- Jack Rafters, 12
- Jack Rafters – *Using Other Than 16 Inch*, 61
- Key definitions, 1
- Lumber Estimation, 38
- Memory and Storage Functions, 2
- Memory Operation, 25
- Multi-Function **Height** Example, 32
- Multi-Function **Width** Example, 31
- Paperless Tape Operation, 27
- Percentage Calculations, 25
- Pitch Ratio, 57
- Polygon, Example, 49
- Polygon Function, 9
- Preference Settings, Appendix B, 83
- Preferences, How to Set, 86
- Rake-Wall Function, 13
- Rake-Wall – *No Base*, 66
- Rake-Wall – *With Base*, 67
- Recall **Rcl** Key, 3
- Regular Hip/Valley and Jack Rafters, 60
- Reset, 92
- Right Triangle and Roof Framing, 54
- Right Triangle/Roof Framing Keys, 10
- Rise, 59
- Rise and Diagonal, 59
- Roof Covering – *Entering Pitch, Length and Width*, 68
- Roof Covering – *Entering Rise, Run (No Pitch) and Area*, 69
- Roof Framing Definitions, 55
- Roof Materials/Covering Function, 14, 68
- Setting Fractional Resolution, 20
- Sheathing Cut, 60

Square Area, 31
Squaring-Up a Foundation, 51
Stair Key, 14
Stair Layout Definitions, 70
Stair Layout Examples, 70
Stairs – *Given Only Floor-to-Floor Rise*, 72
Stairs – *Given Only the Run*, 74
Stairs – *Given Rise and Run*, 75
Stairs – *Given Rise and Run, Using “Riser Limited” Function for Code Restrictions*, 76
Studs Function, 16
Studs, Number of, 78
Time Calculations Using D:M:S, 78
Trigonometric Keys (Trig #4080 and Desktop #44080 Models only), 16
Volume Calculations, 32
Volume, Concrete Columns, 47
Volume, Concrete (Complex), 48
Volume, Concrete (Driveway), 46
Volume, Cone, 33
Volume, Cylinder, 33
Volume, Rectangular Containers, 32
Warranty, 96
Warranty Repair Service, 96
Weight Keys, 5
Window Measurement, 30



4840 Hytech Drive
Carson City, NV 89706 U.S.A.
1-800-854-8075 • Fax: 1-775-885-4949
E-mail: info@calculated.com
www.calculated.com



Designed in the United States of America

Printed in China

3/06



UG4065E-F