

# Elite

BY MAXI-MATIC®

## PLATINUM

## 6Qt. Digital Pressure Cooker



Model EPC-608  
EPC-608W

### INSTRUCTION MANUAL

Before operating your new appliance,  
please read all instructions carefully and keep for future reference.

# TABLE OF CONTENTS

IMPORTANT SAFEGUARDS	2
ABOUT YOUR PRESSURE COOKER	4
PARTS & FEATURES	5
BEFORE FIRST USE	6
<i>Lid Assembly</i>	6
<i>Dismantling &amp; Installing</i>	7
PREPARING YOUR PRESSURE COOKER	8
OPERATING INSTRUCTIONS	10
<i>How to Use the Menu Buttons</i>	10
<i>How to use the Pressure Cook Time</i>	12
<i>How to use the Pre-Set Timer</i>	13
<i>How to Brown/Sauté</i>	14
<i>How to Reheat or Keep Warm</i>	14
<i>How to cook Frozen foods</i>	14
<i>How to Pressure Can</i>	15
CARE & CLEANING	16
FREQUENTLY ASKED QUESTIONS	17
COOKING CHARTS	19
RECIPES	22
WARRANTY & CUSTOMER SERVICE	Back

**CAUTION – To ensure continued protection against the risk of electric shock connect to properly grounded outlets only.**

This appliance has a **three-prong plug** (meaning there are three prongs to fit into a power outlet), please follow the below instructions:

To reduce the risk of electric shock, this plug is intended to fit into a three-prong power outlet only in one direction. If it does not fit, contact a qualified electrician. Do not attempt to modify the plug in any way.

**NOTE:** A short power cord is provided to reduce the risk of personal injury resulting from becoming entangled in or tripping over a longer cord.

**Longer power-supply cords or extension cords are available and may be used if care is exercised in their use.**

If an extension cord is used: (1) the marked electrical rating of the extension cord should be at least as great as the electrical rating of the product; (2) the extension cord should be arranged so that it will not drape over the countertop or tabletop where it can unintentionally be pulled on or tripped over by children or pets.

# IMPORTANT SAFEGUARDS

**When using pressure cookers, basic safety precautions should always be followed:**

1. Read all instructions before operating your pressure cooker.
2. Do not operate while unattended.
3. Do not touch hot surfaces. Use handles or knobs.
4. Close supervision is necessary when the pressure cooker is used near children.
5. DO NOT allow children to operate under any circumstance.
6. Do not place the pressure cooker in a heated oven or on a stove top.
7. Extreme caution must be used when moving a pressure cooker containing hot foods.
8. Do not use pressure cooker for other than intended use.
9. Never immerse machine in water or other liquids.
10. This appliance cooks under pressure. Improper use may result in injury.
11. Make certain the unit is properly closed before operating. See Operating Instructions.
12. Do not fill the unit over 4/5 full. When cooking foods that expand during cooking such as rice or dried vegetables, do not fill the unit over 3/5 full. Over filling may cause a risk of clogging the vent pipe and developing excess pressure. Failure to follow this procedure can result in injury to person(s) and/or damage to the unit.
13. Be aware that certain foods, such as applesauce, cranberries, pearl barley, oatmeal or other cereals, split peas, noodles, macaroni, rhubarb, or spaghetti can foam, froth, and sputter, and clog the pressure release device (steam vent). These foods should not be cooked in a pressure cooker.
14. Always check the pressure release devices for clogging before use.
15. Do not open the pressure cooker until the unit's internal pressure has been released completely. If the lid is difficult to slide open, this indicates that the cooker is still pressurized – do not force it open. Any pressure in the cooker can be hazardous. See Operating Instructions.
16. Do not use this pressure cooker for pressure frying with oil.
17. DO NOT place the product near flammable materials or use in a humid environment.
18. DO NOT damage the Rubber Seal and DO NOT replace it with anything other than the replacement designated for this unit.
19. DO NOT tamper with the Steel Ring in the Lid (2) with any tools or external forces. If the Steel Ring is damaged (2), please stop using immediately and replace the Lid.
20. Clean the Filter (20) regularly to keep the pressure cooker clean.
21. NEVER use additional weight on the Pressure Limiting Valve (3) or replace the Pressure Limiting Valve (3) with anything not intended for use with this unit.
22. The surface of contact between the Inner Pot (8) and the Electronic Heater (18) should always be clean. DO NOT use the Inner Pot with other heating sources. DO NOT replace the Inner Pot with a container other than what is recommended by the manufacturer.
23. The Inner Pot consists of a non-stick layer surface. To avoid scratching the non-stick surface, please use wooden or plastic utensils.
24. Food should not be kept warm for more than 4 hours in order to maintain the freshness of the food. The pressure cooker should not be used for more than 6 hours continuously. Serious Injury and/or damage may occur if any safeguards are ignored.
25. If steam releases around the Lid (2) during the cooking process, please turn the machine off. Allow it to cool and check the Rubber Seal. Please contact our Customer Service for any trouble-shooting information.
26. If there is any malfunction of the cooker during the cooking process, please stop using the device and contact our Customer Service for any trouble-shooting information.
27. DO NOT disassemble the product, or replace parts with parts not intended for this unit. Always contact our Customer Service for any trouble-shooting information.

28. This appliance is not intended for use by persons (including children) with reduced physical, sensory or mental capabilities, or lack of experience and knowledge, unless they have been given supervision or instruction concerning use of the appliance by a person responsible for their safety.
29. Unplug from outlet when not in use and before cleaning. Allow to cool before putting on or taking off parts.
30. Do not operate any appliance with a damaged cord or plug or after the appliance malfunctions or has been damaged in any manner. Return appliance to the nearest authorized service facility for examination, repair or adjustment.
31. The use of accessory attachments not recommended by the appliance manufacturer may cause injuries.
32. Do not use outdoors.
33. Do not let cord hang over edge of table or counter, or touch hot surfaces.
34. Always attach plug to appliance first, then plug cord into the wall outlet. To disconnect, turn any control to "off", then remove plug from wall outlet.
35. DO NOT move the appliance when it contains hot food or liquid.
36. A short detachable power-supply cord should be used to reduce the risk resulting from becoming entangled in or tripping over a longer cord.
37. Longer detachable power-supply cords or extension cord are available and may be used if care is exercised in their use.
38. If a longer detachable power-supply cord or extension cord is used:
  - The marked electrical rating of the cord set or extension cord should be at least as great as the electrical rating of the appliance.
  - The cord should be arranged so that it will not drape over the countertop or tabletop where it can be pulled on by children or tripped over unintentionally.
39. If the appliance is of the grounded type, the extension cord should be a grounding-type 3-prong cord.

# SAVE THESE INSTRUCTIONS

## FOR HOUSEHOLD USE ONLY

**SAFETY WARNING:** There is a potential risk of fire, electric shock or injury to persons if the product is not used as instructed. Protection against electric shock is assured only if the main power cord is connected to a properly grounded 120V | 60Hz power receptacle.

- This product is to be used in an indoor environment only and is not intended for commercial use. Dry locations only.
- All parts and accessories for this appliance must be used properly according to the instructions. All parts and accessories must be the original provided from manufacturer. All other parts or accessories that are not intended for use with this appliance is strictly prohibited.
- The use of an extension cord, power adapter or other electrical device is not recommended due to possibility of short circuit.

### LED ERROR INDICATOR

Indicator Code	Problems/Causes
E1	Open Circuit of the Sensor
E2	Short Circuit of the Sensor
E3	Overheating
E4	Signal Switch Malfunction

# ABOUT YOUR PRESSURE COOKER

This digitally controlled and automatic electric pressure cooker uses advanced technology so you and your family can enjoy the benefits of better, faster and healthier cooking. Your Elite Pressure Cooker seals in steam to cook hotter and faster while maintaining important nutrients for healthier meals. Cook fast and with less water to save vital natural resources and energy. The pressure cooker features easy touch-button settings, a countdown timer, and a very large cooking pot big enough for family gatherings! It's the easiest pressure cooker to use on the market. It may seem like a complicated unit but rest assured, this pressure cooker is simple to use, makes meals quick and easy, and overall it saves you money!

## **PRESSURE COOKER WITH MULTIPLE FUNCTIONS:**

Multiple functions for cooking, stewing, braising, simmering, and roasting:

- Cooking will be done automatically by selecting the different menu choices on the unit. When the food has completed its cooking cycle, there will be a (3) beep indicator, followed by the unit automatically switching to the Keep Warm mode.
- This unit also allows the user to choose the period of Pressurized Cooking Time (0-99 minutes) according to one's taste and needs in addition to the Pre-Set menu.
- A preset timer allows the user to preset the cooking time up to 24-hours. When the timer is set, the count-down will start. By the end of the countdown, the cooker will start to heat up.
- The pressure cooker also has its own memory. Interruptions such as a power failure will automatically renew the cooking cycle where the unit left off when the power resumes.

## **RAPID COOKING; TIME & POWER SAVING:**

- By using high pressure (high temperature), food will be cooked much more rapidly. This will reduce the cooking time and consumption of power. For example: when cooking rice, this pressure cooker will save up to 20% of the electricity and up to 15% of the time when compared to a conventional rice cooker. When cooking stew, soups or braising meats, this cooker will save more than 40% of time and more than 45% of power as compared to a conventional slow cooker. Cooking can also be done at high altitudes.

## **PRESERVE NUTRIENTS & PROMOTES HEALTHY EATING:**

- Airtight cooking methods preserve nutrients and original flavor of food.

# PARTS & FEATURES

Floater Valve

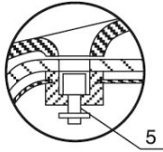

take off and fix filter

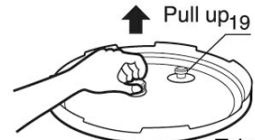

Dismantling of steam water storage

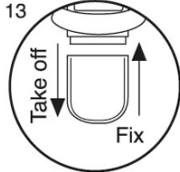

Take off  
20  
Press down

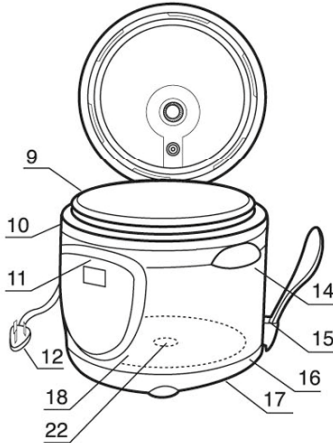
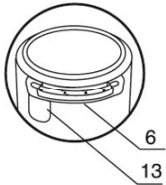
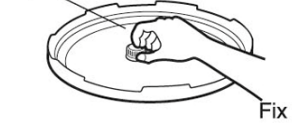

take off and fix sealing belt  
21  
Press down

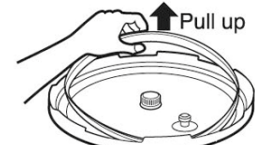
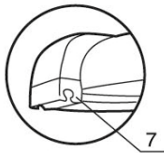
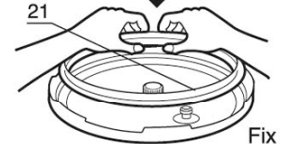

Take off

Accessories



Measuring Cup



spoon

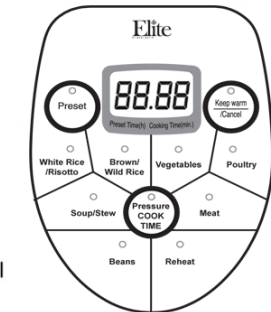

Control Panel

1. Handle
2. Lid
3. Pressure Limiting Valve
4. Float Valve (external view)
5. Float Valve (internal view)
6. Lid Lock-Slider
7. Sliding Latch for Lid
8. Inner Pot

9. Outer Pot
10. Upper Body & Handle
11. Control Panel
12. Power Cable
13. Steam Condensation Cup
14. Body Cover/Structure
15. Spoon/Ladle Holder
16. Lower Body Base

17. Bottom Base
18. Electronic Heater
19. Float Valve Seal Ring
20. Filter
21. Rubber Seal Ring
22. Sensor

# BEFORE FIRST USE

Working Pressure	PSI	Maximum Pressure	Keep Warm Temperature	Preset Timer Half Hour Increments
0~70kPa	12 PSI	90kPa	140°F ~ 175 °F	1~24 Hours

1. Remove packaging materials such as cardboard, plastics or Styrofoam and discard appropriately.
2. Clean all the parts by wiping with a soft damp cloth or sponge and dry thoroughly.

## LID ASSEMBLY:



1. **How to open the lid:** When the lid (2) of the cooker is at the Closed position (Figure 1), hold the Handle (1) and turn it clockwise until you reach the Opened-Lid position (Figure 2). Lift up and the lid will swing open vertically.

**CAUTION:** When hot, always make sure to use a protective glove/mitt when opening the lid to prevent hot steam injury. Keep exposed face or hands away from opening.

**NOTE:** For new units, the seal of the lid may be slightly stronger than normal and may be slightly difficult to unlock. Once the lid has been opened and closed several times, it will loosen up.



2. **How to close the lid:** When the Lid (2) of the cooker is in vertical position (Figure 4), hold the Handle (1) and close it downwards at the Opened Lid position (Figure 5). Turn counter-clockwise until you reach the Closed Lid position. (Figure 6).

## DISMANTLING & INSTALLING LID:

---

3. **How to dismantle/remove the lid:** When the lid (2) of the cooker is in the upright vertical position (Figure 7), hold the lid with both hands, and adjust the height between the Lid and the upper edge of the cooker to approximately 10cm (Figure 8). Then turn it counter-clockwise until you reach the Closed Lid position (Figure 9). In order to remove the lid, you will need to move in an upward direction (Figure 10).

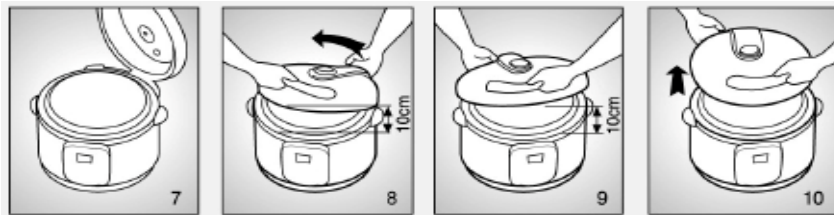

4. **How to install the lid:** Hold the Lid (2) with both hands at the Closed Lid position and pull it upwards in a slanted position which leads to a height of 10cm between the Lid and the upper edge of the cooker (Figure 11). Align the Lid's Sliding Valve (7) to the pressure cooker's Lock-Slider (6) and turn it in a clockwise direction until you reach the Opened Lid position (Figure 12). The lid will be installed when the lid is seated and in the horizontal position (Figure 13).

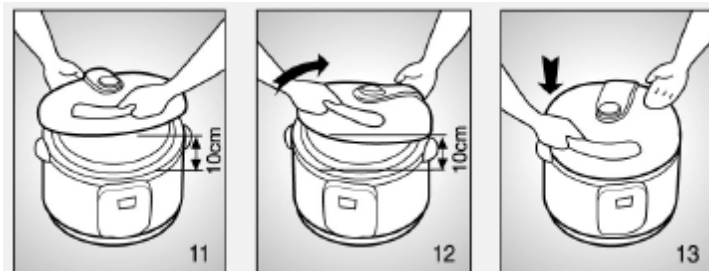

**TIP:** Position the lid above the unit with the open hinge latch positioned right above the hinge bar. Then firmly push down on the lid to snap it into position. Slide the lid left and right to ensure a smooth connection.



# PREPARING YOUR PRESSURE COOKER

1. To open the lid, hold the Handle (1) and turn it in a clockwise direction until you reach the Opened Lid position. Then pull upwards to vertical position (Figure 14 & 15).

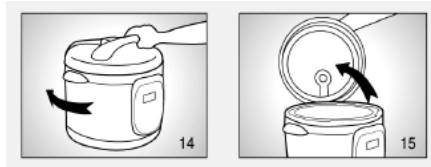

2. Remove the inner pot (8) and place desired food and liquids into the pot. The amount of water and food should not exceed  $\frac{4}{5}$  of the height of the inner Pot (Figure 16.) For food that will expand in water, the level should not exceed  $\frac{3}{5}$  of the Inner Pot (Figure 17). The minimum level for cooking would be  $\frac{1}{5}$  of the Inner Pot (Figure 18).

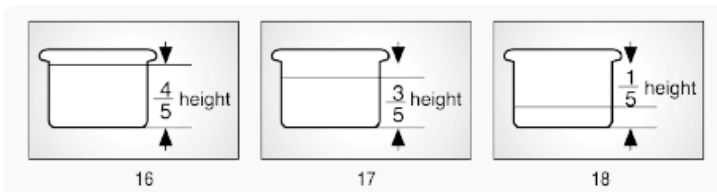

- When cooking rice, the maximum amount of rice allowed for this pressure cooker is 12 cups of uncooked rice.
  - Normally one cup of rice requires one cup of water. This may vary according to taste.
3. Be certain the inner lining receptacle, where the Electronic Heater is located, is clean before inserting the inner pot. Place the inner pot into the pressure cooker and adjust the pot left and right to ensure optimal contact between the Inner Pot and the Electronic Heater. (Figure 19)

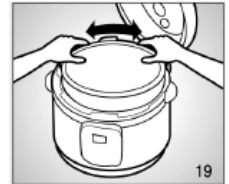

4. Closing the lid.
- Make sure the Rubber Seal Ring (21) is fitted properly onto the inner part of the lid (2).
  - Observe the Rubber Seal Ring (21) inside the Lid (2) and ensure that it is evenly fitted into the track. **(Caution: If the rubber seal ring is damaged, do not use the pressure cooker. Contact Customer Service to repair or replace.)**
  - Close the lid.
  - Hold the Handle (1) and turn it to the “Closed” position or Counter -clockwise. (Figure 20 & 21).

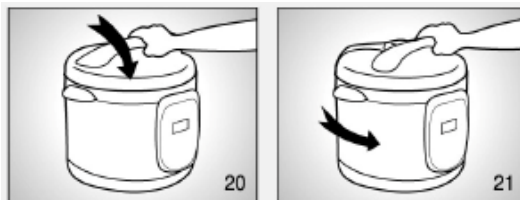

5. Adjust the Pressure Limiting Valve (3) to the “Air Tight” position, and ensure that the Float Valve (5) is in the sunk “down” position. (Figure 22a & 22b)

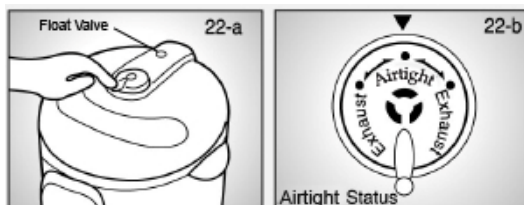

### NOTES & TIPS #1:

- Please note that the Pressure Limiting Valve (3) will be loose when you are not using the unit for cooking. It will rock slightly and will turn 360° manually. Once the pressure cooker is in operation and the pressure has built up to its capacity, the Pressure Limiting Valve (3) will tighten securely, only allowing itself to be turned to the Left or Right to “Exhaust”. Once all the pressure has released, it will become loose again.

# OPERATING INSTRUCTIONS

## HOW TO USE THE MENU BUTTONS:

There are eight Menu Buttons programmed for your pressure cooker. These are provided for quick and easy cooking for small portions of food in addition to manual programming. (When cooking food that is more than 3-4lbs. or more than 6-cups, please use the Timed Cooking function.) Each of these choices is programmed to detect the weight of food being cooked and how much liquid is inside the pot during the cooking cycle. The unit will automatically build up the pressure, cook the food and go to Keep Warm automatically when cooking is complete.

### MENU BUTTON SELECTIONS & APPROXIMATE COOK TIMES:

<b>WHITE RICE / RISOTTO</b>	10 minutes	<b>VEGETABLES</b>	5 minutes
<b>SOUP / STEW</b>	18 minutes	<b>POULTRY</b>	20 minutes
<b>BEANS</b>	25 minutes	<b>MEAT</b>	26 minutes
<b>BROWN / WILD RICE</b>	24 minutes	<b>REHEAT</b>	11 minutes

- 1) Prepare desired food and place into cooking pot. (Recommended portions for the Menu Function are 3lbs. or 6 cups. Any food over this amount, please see the Pressure Cook Time section.)
- 2) Secure the lid onto the unit, turn it Counter-clockwise to lock it properly in place.
- 3) Make sure the Pressure Limiting Valve (3) is set to the "Airtight" position.
- 4) Plug the power cord into a 120V power outlet.
- 5) The machine will beep and the LED screen will display **0000**.
- 6) Choose the desired Menu Function and press the button, the indicator light will illuminate and the LED will display the pre-programmed cook time. The pressure cooker will begin to operate.
- 7) When proper pressure is achieved, the LED screen will display a letter "P". (For example when the Meat Menu Button is selected: **P026** will display and the 26-minutes will begin to count down after Pressure has been achieved.)
- 8) When the unit has pressurized, it will begin to pressure-cook the food. You may hear quiet hissing or sizzling sounds coming from inside of the unit during this time.

### NOTES & TIPS #2:

- During the Pressure Building process, you may notice steam or pressure escaping from the Pressure Limiting Valve (3). Carefully adjust the valve by moving it gently or turning it side to side gently using tongs or similar utensil until it seals properly.
- If any steam is escaping around the lid, it means that the Rubber Seal Ring (21) may not have completed a tight seal when the lid was locked. Cancel the cooking process, release pressure manually or naturally, remove the lid and check the Rubber Seal Ring (21). Reposition the lid and ensure that it is secure. Start the cooking process again.

### NOTES & TIPS #3:

- When cooking soups or stews with other hearty ingredients such as potatoes or meat, as much as 3 to 6 cups of liquid must be used to prevent ingredients from over-cooking or burning.

- 9) When cooking has completed, the pressure cooker will beep 3-times and automatically go to Keep Warm.
- 10) The Keep Warm indicator light will illuminate. The Pressure Cooker will automatically release the pressure naturally. This will take approximately 10-15 minutes.
- 11) If you wish to Quick Release the pressure, move the Pressure Limiting Valve (3) to “Exhaust” position to release the pressure until the Float Valve (5) sinks. (Figure 23a & 23b).

**CAUTION: Keep hands and face away from Pressure Limiting Valve while in the Exhaust position. Failure to comply may cause serious injury.**

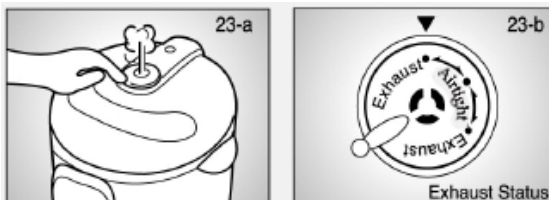

- 12) Always be certain the pressure is released completely before unlocking the lid and opening it.  
**CAUTION: Keep exposed hands and face away from the opening when opening the lid. Failure to comply may cause serious injury.**
- 13) Remove food to serve immediately or press the Keep Warm button to keep food warm. (It is not recommended to keep food warm for over 4-hours).

#### **NOTES & TIPS #4:**

- NATURAL RELEASE is recommended when cooking foods that will not have the tendency to overcook such as Potatoes, Beans, Soups & Stews. During the Natural Release time period (approximately 10-15 minutes), the pressure cooker may still be heated and cooking the food slightly.
- QUICK RELEASE is recommended when cooking foods that you wish to be Medium or Medium-Rare such as Beef Roasts or Lamb. This will release the pressure quickly and prevent the food from over-cooking.

## HOW TO USE THE PRESSURE COOK TIME:

Setting your own cook time is ideal for cooking meat or poultry that weighs more than 3-pounds. It is also suggested for slow-cooking certain recipes that require cooking for more than 30-minutes. The programmed cook time can be set up to 90-minutes.

- 1) Prepare desired food and place into cooking pot.
- 2) Secure the lid onto the unit, turn it Counter-clockwise to lock it in place properly.
- 3) Make sure the Pressure Limiting Valve (3) is set to the "Airtight" position.
- 4) Plug the power cord into a 120V power outlet.
- 5) The LED screen will display **0000**.
- 6) Press "Pressure Cook Time" button to the desired time frame.  
(EX: If you set the cook time to 30-minutes, the LED screen will display **0030**)
- 7) **The "Pressure Cook Time" indicator light will flash for 5-seconds and automatically stop and set on its own if no other buttons are pushed.**

**NOTE:** The LED screen will not immediately display a P until the proper pressure has been achieved. This may sometimes take up to approximately 5-minutes.

- 8) The pressure cooker will begin to operate.
- 9) When optimum pressure is achieved, the LED screen will display **P030**
- 10) When the unit has pressurized, it will begin to pressure-cook the food. The programmed time will begin to count down until it reaches zero.
- 11) When cooking is complete, the pressure cooker will beep 3-times and automatically go to Keep Warm.
- 12) The Keep Warm indicator light will begin to flash/flicker. This indicates the Pressure Cooker is Naturally Releasing the pressure. (See Notes & Tips #4)

## HOW TO USE THE PRE-SET TIMER:

If you wish to program your pressure cooker to automatically cook prepared food, you can Pre-Set the pressure cooker for up to 24-hours. (\*See Tip Caution #5)

- 1) Prepare desired food and place into cooking pot.
- 2) Secure the lid onto the unit, turn it Counter-clockwise to lock it in place properly.
- 3) Make sure the Pressure Limiting Valve (3) is set to the “Airtight” position.
- 4) Plug the power cord into a 120V power outlet.
- 5) The LED screen will display **0000**.
- 6) Press the **PRESET** button to increase the timer by 1/2-hour increments. The maximum Preset period is 24-hours. After 24-hours, the timer will start a new cycle. (The time that displays on the LED screen shows how long the user wants the unit to wait before the cooking process begins. EX: If you wish to program the pressure cooker to automatically turn on in 3.5-hours, press the **PRESET** button until the LED screen displays **35 00**).
- 7) After choosing the desired pre-set time, choose your pre-set function or cooking time.

### MENU BUTTONS:

- Press one of the eight pre-programmed MENU BUTTONS. The Menu Button indicator light will illuminate. Your pre-set timer has been programmed.
- After the pressure cooker counts down to automatically turn on, it will follow the cooking sequence for Menu Button Operation.
- When cooking is complete, the pressure cooker will beep 3-times and automatically go to Keep Warm. (See Notes & Tips #5)

### COOKING TIME:

- Press the SET PRESSURE COOKING TIME to desired cook time. EX: If you wish to program to cook for 60-minutes. The LED screen will display **35 60**).
- **The “Pressure Cook Time” indicator light will blink for 5-seconds and automatically stop and set on its own if no other buttons are pushed.**
- After the pressure cooker counts down to automatically turn on, it will follow the cooking sequence for desired cook time.
- When cooking is complete, the pressure cooker will beep 3-times and automatically go to Keep Warm. (See Notes & Tips #5)

### NOTES & TIPS #5:

- It is recommended to release the pressurized steam when the “Keep Warm” LED stops flashing as the pressure cooker will have lower pressure. This will require a little more time. (Approximately 5-10 minutes).
- For foods with a high volume of liquid (Stews, soups, porridges, etc.) **IT IS NOT RECOMMEND TO USE QUICK RELEASE**. This is to avoid liquid splatter from the ventilation in the Pressure Limiting Valve (3).
- **NATURAL RELEASE:** User should wait for the temperature to drop and the Float Valve to sink on its own prior to opening the lid.

**\*CAUTION: It is not recommended to use the Pre-Set Timer function to cook foods that may spoil. Leaving raw foods inside the pressure cooker for long periods of time prior to cooking may result in the food spoiling. Recommended items such as rice, beans, grains or similar foods will not spoil.**

## **HOW TO BROWN/SAUTÉ INSIDE THE PRESSURE COOKER:**

Certain recipes suggest that you brown meat or sauté vegetables to ensure juices are retained during cooking. It also provides nice coloring when meat or vegetables are cooked and ready to serve.

To brown or sauté:

1. Open and/or remove the lid depending on your preference.
2. Press the **BROWN / WILD RICE** button to manually begin the heating process.
3. Put food into the Inner Pot (8) and brown/sauté to desired consistency.

### **NOTES & TIPS #6:**

During Browning/Sautéing, the pressure cooker will automatically set itself to Keep Warm when it reaches a high temperature. (Approximately 5-minutes). If you are browning/sautéing a large quantity of food, you may need to allow the unit to cool slightly for 1-2 minutes before pressing the BROWN / WILD RICE button again. It is possible that the internal sensor will prevent any other buttons from activating to avoid over-heating.

4. When ready to start the pressurized cooking cycle: Press “Keep Warm/Cancel” button to cancel the browning/sautéing process.
5. Close the lid and secure properly.
6. Follow the instructions on cooking to your preference.

## **HOW TO USE THE REHEAT or KEEP WARM FUNCTION:**

Food can be prepared at an earlier time and kept warm inside the pressure cooker using the Keep Warm function or reheated using the Reheat function. Food can be kept warm for up to 4-hours. Additional time may cause a change in flavor, appearance or cause food to spoil.

- 1) Prepare desired food and place into inner pot.
- 2) Secure the lid onto the unit and turn it Counter-clockwise to lock it in place properly.
- 3) **It is recommended to set the Pressure Limiting Valve (3) to “Exhaust” at this time since you are only reheating or keeping food warm and not pressurizing.**
- 4) Press the Reheat or Keep Warm button. The indicator light will illuminate solid.
- 5) The pressure cooker will start to heat and maintain a lower temperature to keep warm.
- 6) To cancel, simply press the Cancel button until indicator light is no longer illuminated.
- 7) Remove food and serve.
- 8) Unplug power cord and allow to cool completely before dismantling and cleaning.

## **HOW TO COOK FROZEN FOODS:**

Cooking frozen food inside a pressure cooker is quick and easy but has certain restrictions. Only cook individual cuts of frozen meats that are up to 1 inch thick, the cooking time does not need to be altered. Pressure will not be achieved until the internal temperature has reached a preset level. If the recipe states the meat be cooked for 10 minutes after pressure has been achieved, it will still be the same, but it will take longer to reach pressure point.

It is not recommended to pressure cook larger cuts of frozen meats such as a whole roast, a block of frozen ground meat or a whole chicken. Larger cuts will require increased cooking times of up to one third more, and the results may not be the same when compared to meats that were thawed (or at least partially thawed) and browned before cooking.

# HOW TO USE THE PRESSURE COOKER FOR CANNING:

It is recommended to purchase a separate instructional book that is specific to Canning. These books can be purchased at a local book store or on the internet.

This pressure cooker can be used to do basic pressure canning and the water-bath method.

Low-Acidic fruits and vegetables and High-Acidic fruits and vegetables are recommended. It is not recommended to can foods such as meat or seafood products in this unit. It is not recommended to use this pressure cooker for canning at high or low altitudes.

Before using this unit for canning purposes, check with the USDA for food preservation guidelines or read the publications listed at [http://www.uga.edu/nchfp/publications/publications\\_usda.html](http://www.uga.edu/nchfp/publications/publications_usda.html)

- Always use canning supplies specifically manufactured for canning purposes. It is recommended to use mason jars that are 32-ounces or smaller. Do not stack jars on top of each other.
- Always inspect your canning supplies to ensure proper function and safety. Avoid using jars with chips, nicks, cracks or other imperfections in the glass, rims or lids.
- Wash jars thoroughly in hot water according to manufacturer's instructions.
- Prepare food and fill mason jars and seal according to manufacturer's instructions.
  - Always make sure there is 1-inch of headspace in the jars.
  - Use a thin utensil to release any trapped air between the food and the jar by pressing food firmly to the sides to dislodge any air bubbles.
  - Set jar lids onto the jar and screw on the outer rings until tight, then unscrew ¼ turn.
- Place jars into the inner pot. desired, use clean dish towels to tuck around the jars to prevent them from touching each other or the sides of the inner pot.
- Fill inner pot with 6-cups of water. (Certain canning recipes may require a different amount of water.)
- Secure the lid onto the pressure cooker, turn it Counter-clockwise to lock it in place properly.
- Make sure the Pressure Limiting Valve (3) is set to the "Airtight" position.
- Plug the power cord into a 120V power outlet.
- Follow canning recipe for the type of food you are canning and program the "Pressure Cooking Time" for the specified time frame for the size of jars and type of food recipe you are using. (EX: If you set the cook time to 30-minutes, the LED screen will display **00 30**)
- The pressure cooker will begin to operate.
- When pressurization has been achieved, the LED screen will display **P0 30**
- When the unit has reached optimum pressure, it will begin to pressure-seal the mason jars. The programmed time will begin to count down until it reaches zero.
- When time has expired, the pressure cooker will beep 3-times and automatically go to Keep Warm.
- The Keep Warm indicator light will illuminate. This indicates the Pressure Cooker is proceeding to Naturally Release the pressure. (See Notes & Tips #4)
- Open lid once pressure has completely released which is indicated by the Keep Warm indicator light staying illuminated.
- Carefully remove jars using special canning utensils or tools. **CAUTION:** Jars are hot!
- Set jars on a towel or cooling rack and allow to cool completely in a draft-free location.
- Follow recipe instructions on cooling and storage.

## **NOTES & TIPS #7:**

- While the jars are cooling, a small "click" sound will come from the lids to indicate the lids are sealing properly.
- After approximately one hour, check to be sure the flat lids have obtained a good seal by pressing down with your thumb; the lid should remain stiff with no movement.
- If you have not achieved a good seal within 2 hours, the canning did not work properly and the ingredients will need to be refrigerated and used within 3 days or frozen in a freezer container.



## CLEANING & MAINTENANCE

1. Always make sure the Pressure Cooker is unplugged, depressurized and completely cooled down before dismantling.
2. Use a non-abrasive sponge or damp wash cloth to clean the exterior of the outer body (9) and the exterior surface of the pressure cooker. **NEVER** immerse the pressure cooker in any liquids.
3. Remove the Steam Condensation Cup (13) and rinse it thoroughly and let dry. Clean the Upper Body (10) with a damp sponge or wash cloth.
4. Clean the Lid (2) with warm soapy water, including the Seal Belt (21), Pressure Limiting Valve (3), Filter (20), Vent, Float Valve (5) and let dry thoroughly.
  - The Pressure Limiting Valve (3) pops off easily by gently reaching underneath it and gently prying upwards. Be careful not to damage the thin wire spring under it.
  - On the underside of the lid below the Pressure Limiting Valve (3), is a small metal filter cap which can be removed easily to clean.
5. Let parts dry completely before reassembling.
6. Wash the Inner Pot (8) with a non-abrasive sponge and allow to air dry or use a towel.
7. Clean the Pressure Limiting Valve (3) and the holes with a small brush to ensure smooth flow of steam during the release cycle.

**NOTE:** Any servicing required shall be performed by an authorized service representative or from the original manufacturer or distributor

## FAQ (FREQUENTLY ASKED QUESTIONS)

- 1) Is the Airtight/Exhaust Valve Knob on the top of the lid supposed to be loose?**
  - If you are not cooking or using the unit, the Valve Knob will be loose. It will turn 360 degrees and may even come off if you pull on it. Once you start using the pressure cooker and the pressure has built up, and the Valve Knob is set to "Airtight" properly, it will not be loose anymore.
  - Sometimes during cooking and pressurizing, steam may escape from the Valve. It indicates the Valve is not seated properly/securely. Simply use tongs or similar utensil and gently/carefully adjust it so it is seated properly.
  
- 2) When I choose a Menu Button (ex: Meat & Chicken), nothing happens? What's wrong?**
  - Nothing is wrong.
  - Make sure the Valve on top is set to Airtight and the lid is locked securely. Once you have selected the Menu Button, simply leave the unit alone and it will start to heat up and build up pressure. This sometimes may take up to 5-10 minutes depending on what you're cooking.
  - Once the unit has built up enough pressure, the LED display will change to a letter **(P)**. This is the time the unit will start cooking the food. This may take up to 5 minutes.
  - The unit will then start to cool down and de-pressurize on its own. It will beep 3 times. The **(P)** will turn back to a **(0)** and the Keep Warm light will begin to blink.
  - During this time, the food inside is still cooking. Depending if you want your food to be cooked longer, you can allow the unit to naturally release the pressure by letting the unit sit. (Some meats will keep cooking once the pressure is released, so if you prefer your meat to be Medium or Medium-Rare, we suggest the quick release.)
  - Once the pressure has completely released, the floating valve will drop down. You can unlock the lid and open to check on your food.
  
- 3) What is the little black plastic piece that came in the accessory bag?**
  - This is part #15 on the instruction manual. Some may think it is part #7, but it is not. It is the spatula/spoon holder that latches onto the side of the pressure cooker. Refer to the instruction manual for the parts indicator to determine the location of where to attach #15 part.
  
- 4) When I set the pressure cooker using the Manual Pressure Cooking time OR the Preset Menu Buttons, it will begin to build pressure heat up, but in about 5-minute the unit beeps 3 times and goes to Keep Warm and my food did not cook completely. What is happening?**
  - The unit is sensing that there is a leak in the pressure and that it is not sealed up properly. Check the unit thoroughly. Make sure the rubber gasket ring is in place, the lid is securely locked, and that the Valve on top of the lid is set to the "Airtight" position. Reset the unit by unplugging it. Wait 10-seconds and plug it back in. Program the unit again.
  - Another reason this may happen is that not enough liquid has been added to your recipe. The pressure cooker has an automatic over-heat prevention sensor that will automatically set itself to OFF or to Keep Warm when it senses that no liquid is present so it does not over-heat. Add more liquid to the contents and stir.

- 5) **Steam is being released around the rim of the lid during the pressurizing sequence. How do I fix this?**
- The Rubber Sealing Ring did not make a proper seal. Cancel all the functions. Exhaust any remaining pressure and steam. Open the lid and remove it entirely. Check the Rubber Sealing Ring to make sure it is positioned properly. Rub a wet cloth along it to make sure it is clean of debris and it is smooth. Re-assemble the lid, lock it securely in place and restart the cooking process.
- 6) **Steam is being released from the Pressure Limiting Valve during the pressurizing sequence. How do I fix this?**
- The Valve may not be positioned properly. Simply use tongs or similar utensil or oven mitt and carefully adjust it so it is seated properly. If the steam continues to release, you may need to Cancel all the functions. Exhaust any remaining pressure and steam. Remove the Pressure Limiting Valve and check the thin wire spring on the underside of it. Make sure it is not bent or loose. If steam still continues to escape, the Valve may be faulty and replacement or repair may be necessary. Please contact the manufacturer.
- 7) **Pressurized Steam is being quietly released from the Floating Valve area during the pressurizing sequence. How do I fix this?**
- This may happen during the initial start-up of the Pressurizing Sequence. Simply use tongs or similar utensil or oven mitt and carefully adjust it so it is seated properly. This will help settle the lid and all the valves properly. The pressure will quickly push up on the Floating Valve and seal it properly then finish the pressurizing sequence.
- 8) **My food is finished cooking and all the pressure is released, but I cannot unlock and open my lid. What is stuck?**
- Make sure all the pressure and steam have completely been released. Make sure the small Floating Valve is no longer in the up position. It may be stuck in the UP position, simply tap the lid slightly to make it go back down. Then turn the lid clockwise to unlock the lid. If it is still stuck, unplugging the unit may help.

**NOTES & TIPS #9:**

- If recipes require the use of a trivet, riser (wire rack), foil, or heat-resistant/pressure-resistant oven-safe cookware, you may use these accessories in this pressure cooker.
- If you do not have a wire rack that will fit, simply use 3-4 mason jar lids or regular jar lids for a simple 1-inch riser.

# COOKING TIME CHART

Courtesy of [www.healthfoods.com](http://www.healthfoods.com)

Please note that all the below information is for your reference only and can be adjusted according to the user's preference.

## Meat/Poultry

- Always cook meat or poultry with at least 1-3 cups of liquid. If the cooking time exceeds 15 minutes, use 2 cups of liquid. If weight of meat or poultry is 3lbs, use 3 cups of liquid. Preserved or salted meats should be immersed in water.
- Cooking times for meat and poultry may vary according to the quality and quantity of meat or poultry being cooked.
- Unless indicated. The cooking times given below are for 3 pounds of meat or poultry unless noted otherwise. Additionally, the denser the cut, the longer the cooking time should be.

Type of Meat	Approximate Cooking Minutes	Pressure Release
Beef/Veal, roast or brisket	38-42	Quick Release
Beef Meatloaf, 2 lbs.	13-18 or use the Meat Button	Quick Release
Beef, meatballs, 1-2 lbs.	7-12 or use the Meat Button	Natural Release
Beef, Corned	55-65	Natural Release
Pork, roast	43-47	Natural Release
Pork, ribs, 2 lbs.	18 or use the Meat Button	Quick Release
Pork, ham shank	25-28	Natural Release
Leg of Lamb	42-45	Natural Release
Chicken, whole, 2-3 lbs.	15-18 or use the Meat Button	Quick Release
Chicken, pieces, 2-3 lbs.	12-15 or use the Meat Button	Quick Release
Cornish Hens, two	12-15 or use the Meat Button	Quick Release
Meat/Poultry soup/stock	15-20 or use the Meat Button	Quick Release

## Seafood

- Cooking times may vary according to the type of seafood being cooked.
- Cook seafood on a cooking rack with a trivet on the bottom of the pot (if available), and add at least 3/4 cup of liquid. Lightly grease cooking rack with vegetable oil when cooking fish.

Type of Seafood	Approximate Cooking Minutes	Pressure Release
Clams	3-5	Quick Release
Crabs	3-5	Quick Release
Lobster, 1 1/2 - 2 lbs.	3-5	Natural Release
Mussels	3-5	Quick Release
Shrimp	2-3	Quick Release
Fish, whole, gutted	7-8	Quick Release
Fish, Soup or Stock	7-8	Quick Release

## Vegetables

- Always cook with at least 1-2 cups of liquid.
- Add 1-2 additional minutes to cooking time when preparing frozen vegetables.
- Use the quick-release release method at the end of cooking cycle so vegetables will not become soggy. (Below chart is for quantity approximately half a pot).

Type of Vegetable	Approximate Cooking Minutes	Pressure Release
Asparagus, thick whole	2-5	Quick Release
Asparagus, thin whole	1-2	Quick Release
Beans, fava, shelled	5	Quick Release
Beans, green, whole	4-5	Quick Release
Beans, lima, shelled	3	Quick Release
Beets, small, whole	2-3	Quick Release
Beets, large whole	23	Quick Release
Beets, 1-inch slices	5	Quick Release
Broccoli, flowerets	3	Quick Release
Brussel sprouts, whole	5	Quick Release
Carrots, 1-inch chunks	5	Quick Release
Carrots, 1/4-inch slices	1-2	Quick Release
Cauliflower, flowerets	3-5	Quick Release
Corn on-the-cob (4-6)	4	Quick Release
Escarole, coarsely chopped	2-3	Quick Release
Kale, coarsely chopped	2-3	Quick Release
Okra, small pods	3-5	Quick Release
Onions, whole	3	Quick Release
Potatoes, 1 1/2-inch chunks	7	Quick Release
Potatoes, new, small whole	6	Quick Release
Potatoes, sweet and yams, whole, medium	10-12	Quick Release
Potatoes, sweet and yams, 2" chunks	7-8	Quick Release
Spinach, fresh, coarsely chopped	3	Quick Release
Squash, acorn, halved	8	Quick Release
Squash, butternut, 1-inch chunks	5	Quick Release
Squash, summer, zucchini or yellow, 1/2-inch slices	6	Quick Release
Turnips, small quartered	4	Quick Release
Turnips, 1 1/2 inch chunks	4	Quick Release

**\*Split peas and rhubarb can foam, froth, and sputter, and can clog the pressure release device (steam vent). These foods should not be cooked in a pressure cooker.**

### **Dried Beans and Other Legumes**

- Place beans or legumes in pressure cooker. Add 3 cups of water for each cup of beans or legumes.
- Add 1 tablespoon of vegetable oil for each cup of water to cut down on foaming. Do not add salt until after cooking.
- Let pressure drop naturally after cooking.
- Cooking times may vary according to the quality of the beans or other legumes. If still hard after recommended cooking times, continue cooking uncovered. Add additional water, if necessary. (Below chart is for quantity approximately half a pot).

<b>Type of Legume</b>	<b>Approximate Cooking Minutes</b>	<b>Pressure Setting</b>
Azuki	7-8	Natural Release
Black Beans	10-12	Natural Release
Black Eyed Peas	11-12	Natural Release
Chick Peas (garbanzo)	11-13	Natural Release
Gandules (pigeon peas)	8-10	Natural Release
Great Northern	10-14	Natural Release
Kidney Beans, Red	12-14	Natural Release
Lentils, green	10-12	Natural Release
Lentils, soup	8-10	Natural Release
Lentils, red	10-15	Natural Release
Lima Beans	7-8	Natural Release

**\* Applesauce and cranberries, can foam, froth, and sputter, and can clog the pressure release device (steam vent). These foods should not be cooked in a pressure cooker.**

### **Grains**

Before cooking, soak certain grains, such as wheat berries and pearl barley in four times their volume of lukewarm water for at least four (4) hours or overnight if required. Do not add salt to water, since it may toughen the grains and inhibit hydration.

- Do not soak rice.
- Rinse under lukewarm water (this also applies to rice)
- Add rice, then follow with enough water to overlap the rice by 1-inch.

<b>Type of Grain</b>	<b>Approximate Cooking Minutes</b>	<b>Pressure Setting</b>
Rice, basmati – 1 1/2 cups	7-8	Natural Release
Rice, converted – 1 1/2 cups	7-8	Natural Release
Rice, long grain – 1 1/2 cups	7-8	Natural Release
Rice, brown – 1 1/2 cups	17-22	Natural Release
Rice, wild – 3 cups	25-27	Natural Release
Wheat, berries – 3 cups	1	Natural Release

**\* Pearl barley, oatmeal or other cereals can foam, froth, and sputter, and can clog the pressure release device (steam vent). These foods should be cooked in smaller quantities.**

## RECIPES

Please visit the **[Peggy Under Pressure Blog](http://www.peggyunderpressure.com)** for recipes and instructions featuring the Elite Platinum Pressure Cookers. [www.peggyunderpressure.com](http://www.peggyunderpressure.com)

*Please note that all information is for your reference only and can be adjusted according to the user's preference. Results may vary. The blog is in no way affiliated with retail department stores, online shopping sites or television shopping networks. If you have any questions regarding any of the recipes, please contact the author of the blog directly.*

### LEEK & ASPARAGUS RISOTTO

SERVES 4 -6

#### INGREDIENTS

- 1 1/2 tablespoons olive oil
- 1 1/2 tablespoons butter
- 1 1/2 tablespoons water
- 2 garlic cloves, minced
- 1 1/2 cups leeks, sliced
- 1 1/2 cups Arborio rice
- 4 cups vegetable broth
- 1/4 lb asparagus, chopped into 1 inch segments
- 1 1/4 cups parmesan cheese, shredded

#### DIRECTIONS

- In the pressure cooker, heat the olive oil and butter. (Follow the Browning/Sautéing instructions on Page-14 of this manual.)
- Add the garlic and leeks, sauté until soft.
- Add the rice, stir thoroughly and then add broth.
- Close pressure cooker, and press the RICE & RISOTTO function switch.
- While risotto cooks, steam asparagus in water. Then sauté in olive oil. Season with salt and pepper.
- When risotto is done cooking, follow instructions to reduce pressure, then add the sautéed asparagus, and Parmesan cheese.
- Serve immediately.

# **BEEF IN PEPPER SAUCE**

SERVES 4

## **INGREDIENTS**

### **Pepper Sauce**

1 red bell pepper or green bell pepper  
1/2 cup baby carrot  
1 (8 ounce) can tomato sauce (1 tbsp to be use later)  
2 garlic cloves  
2 teaspoons ground ginger  
1 teaspoon turmeric  
1 teaspoon salt  
1/2 teaspoon black pepper  
1/2-1 teaspoon cayenne pepper (depends on how spicy you like it)  
1/2 teaspoon ground cardamom

### **Remaining Ingredients**

2 tablespoons olive oil  
2 lbs boneless sirloin steaks, cut into strips  
salt & pepper  
1 cup water  
1/2 teaspoon paprika  
1/2 teaspoon cumin  
1/2-1 onions, sliced  
1 green bell pepper, sliced

## **DIRECTIONS**

- Remove 1 tablespoon of tomato sauce from the can to be used later. Then blend the ingredients for the pepper sauce (green pepper through cardamom) in a food processor until there are no chunks left. Set aside.
- Pour the oil into the pressure cooker, sprinkle the beef with salt & pepper then brown over heat. . (Follow the Browning/Sautéing instructions on Page-14 of this manual.)
- Once brown add the water, reserved tomato sauce, paprika & cumin. Close the lid and press the MEAT function switch.
- When meat is done, follow instructions to reduce pressure.
- Add the pepper mixture, sliced onions & green peppers to the meat and sauce, cover with lid and press the MEAT function again.
- When cooking is complete, follow instructions to reduce pressure.
- Vegetables should be tender. Serve immediately.



# CHICKEN PICCATA

SERVES 6

## INGREDIENTS

6 chicken breast halves	1 cup pimento stuffed olive, minced
1/2 cup all-purpose flour	1/4 cup sour cream
1/4 cup olive oil	1 tablespoon potato starch or flour
4 shallots	1/4 cup fresh parmesan cheese, grated (1 ounce)
3 garlic cloves, crushed	fontinella cheese, grated
3/4 cup chicken broth	1 lemon, thinly sliced, to garnish
1/3 cup fresh lemon juice	1 teaspoon dried basil
1 tablespoon sherry wine	
2 teaspoons salt	
1/4 teaspoon white pepper	

## DIRECTIONS

- Lightly dust chicken pieces with flour.
- In pressure cooker, heat oil. Add chicken breasts, two at a time, and sauté in hot oil until brown on all sides. (Follow the Browning/Sautéing instructions on Page-14 of this manual.)
- Set aside when finished. (Follow the Browning/Sautéing instructions on page-14 of this manual.)
- Add shallots and garlic to pressure cooker and sauté in oil, scraping bottom of pan to loosen browned particles remaining from chicken. Stir in broth, lemon juice, sherry, salt, pepper, basil, and olives. Mix well.
- Add chicken pieces skin side down back into the pressure cooker with other ingredients.
- Close the lid and press the POULTRY function switch.
- When cooking is complete, follow instructions to reduce pressure.
- Lift lid. Stir chicken mixture, then transfer just the chicken to serving platter, and cover to retain heat.
- Whisk sour cream and starch together. Stir into cooking liquid inside the pressure cooker and cook over manual heat 1 minute, stirring constantly.
- Spoon sauce over chicken. Sprinkle with cheese and garnish with lemon slices.

# ITALIAN POTATO, RICE, & SPINACH SOUP

SERVES 6

## **INGREDIENTS**

1/4 cup olive oil	2 tablespoons fresh lemon juice
6 leeks, white part only, sliced	3 tablespoons tomato paste
3 garlic cloves, crushed	1 tablespoon light brown sugar
2 carrots	10 ounces fresh spinach, rinsed, cut in large pieces
1/2 cup Arborio rice	1/4 cup parmesan cheese, grated
3 potatoes, cut in large chunks	1/4 cup fontinella cheese, grated
5 cups chicken stock	
1/2 cup parsley, chopped	
1/2 cup celery, chopped	
1 bay leaf	
1 teaspoon salt	
1/4 teaspoon pepper	
2 teaspoons dried basil	

## **DIRECTIONS**

- In the pressure cooker, heat oil. Add leeks, garlic, and carrots and sauté in hot oil 2 minutes. (Follow the Browning/Sautéing instructions on Page-14 of this manual.)
- Add rice and potatoes. Stir well and cook 1 minute.
- Add broth, parsley, celery, bay leaf, salt, pepper, basil, lemon juice, tomato paste, and brown sugar. Stir well.
- Secure lid. Press the POTATOES & YAMS function switch.
- Cooking should be approximately 15-20 minutes.
- When cooking is complete, follow instructions to reduce pressure.
- Lift lid. Ladle the soup into large serving bowl or individual bowls
- Combine the cheeses and sprinkle over soup. Serve with hunks of Italian bread.

## CHICKEN ADOBO

SERVES 4 -5

### INGREDIENTS

8-9 chicken thighs	2 tablespoons cooking sherry
2 cups water	1 teaspoon ground black pepper
2 cups low sodium soy sauce	3 tablespoons molasses
1 large onion (cut into rings)	1 tablespoon olive oil
8 garlic cloves (chopped up)	Jasmine rice
3 bay leaves	

### DIRECTIONS

- In the pressure cooker, heat olive oil over heat. Brown the chicken thighs on both sides. (Follow the Browning/Sautéing instructions on Page-14 of this manual.)
- Remove and set aside.
- In pressure cooker, combine water, soy sauce, onion, garlic, bay leaves, sherry wine, black pepper and molasses.
- Add the chicken to the sauce. Stir a bit to get the chicken thighs down into the liquid.
- Close the lid and press the menu function switch for poultry.
- Use this time to cook some jasmine rice.
- When cooking is complete, follow instructions to reduce pressure.
- Lift lid. Remove the bay leaves. Serve chicken and sauce over jasmine rice.

## SPARE RIBS

SERVES 6 -8

### INGREDIENTS

1 cup brown sugar  
1/4 cup soy sauce  
1/2 teaspoon paprika  
1 tablespoon vinegar  
1/4 teaspoon cayenne  
1 teaspoon garlic powder  
2 lbs pork ribs  
1 cup of chicken/beef stock

### DIRECTIONS

- Prepare sauce ingredients inside inner pot.
- Divide ribs up evenly so it fits into the pressure cooker.
- Coat each piece thoroughly with the sauce.
- Place all ribs into pressure cooker pot after coating with sauce.
- Add the 1 cup of stock to the bottom of pot.
- Close the lid, lock and press the MEAT function switch.
- When cooking is complete, use the Quick or Natural release method and remove the lid.

# TUSCAN LAMB SHANK

SERVES 5

## INGREDIENTS

3/4 cup dried great northern beans	1 cup dry red wine
3 1/4 cups water, divided	1/4 cup sun-dried tomato
3 lbs lamb shanks (about 2 large shanks)	1 teaspoon dried rosemary
2 tablespoons all-purpose flour	1 tablespoon Worcestershire sauce
1/2 teaspoon salt	1 (14 1/4 ounce) can low sodium beef broth
1/2 teaspoon fresh ground black pepper	2 tablespoons flat leaf parsley, chopped
2 teaspoons olive oil, divided	5 cups egg noodles, hot cooked (about 4 cups uncooked pasta)
1/2 cup shallot, sliced	
6 garlic cloves, sliced	

## DIRECTIONS

- Sort and wash beans; combine with 3 cups water in a small saucepan. Bring to a boil; cook 1 minute. Remove from heat. Let stand 20 minutes. Drain; set aside.
- Trim fat from lamb. Place flour, salt, and pepper in a large zip-top plastic bag; add lamb. Seal; shake to coat. Remove lamb from bag; shake off excess flour mixture. Reserve 1 1/2 teaspoons flour mixture, and set aside. (Follow the Browning/Sautéing instructions on Page-14 of this manual.)
- Heat 1 teaspoon oil in the pressure cooker over heat. Brown the lamb shanks one by one. Let cook for 8-minutes on each side for Medium doneness. Remove lamb and set aside.
- Add shallots and garlic to the pressure cooker, and sauté 2 minutes using the Browning/Sautéing instructions on Page-14 of this manual.
- Add the beans, 1/4 cup water, reserved 1 1/2 teaspoons flour mixture, red wine, and the next 4 ingredients (wine through broth).
- Close the lid and program the pressure cooker to cook for 30-minutes.
- During cooking of the sauce, go back to the lamb that was set aside. Remove lamb meat from bones; discard bones, fat, and gristle.
- When the sauce is finished cooking, follow instructions to reduce pressure.
- Lift lid. Skim fat from surface. Stir meat into bean mixture. Sprinkle with parsley. Serve over noodles or mashed potatoes.

## **SOUTH OF THE BORDER SPICY CHILI**

SERVES 6

### **INGREDIENTS**

2 tablespoons olive oil	1 bay leaf
2 medium onions, chopped	2 teaspoons celery seed
3 garlic cloves, minced	Salt to taste
1 1/2 lb ground beef	1 tablespoon flour
2 teaspoons ground cumin	1 1/2 cups crushed tomato
2 tablespoons chili powder, or to taste	1 cup beef stock
1 1/2 teaspoons oregano	1 1/2 cups cooked pinto or red kidney beans

### **Garnishes**

Grated cheddar or Monterey Jack cheese  
Finely chopped onion  
Shredded lettuce

### **DIRECTIONS**

- Heat the oil in the pressure cooker and sauté the onion and garlic until the onion is wilted. (Follow the Browning/Sautéing instructions on Page-14 of this manual.)
- Add the beef and cook until it is browned. Mix the cumin, chili powder, oregano, bay leaf, celery seed, salt and flour. Stir in the crushed tomato and beef stock. Add beans.
- Lock the lid in place and press the SOUP & STEW button. When cooking is complete, use the Quick release method and remove the lid. Serve in bowls, passing the garnishes separately.

## **SWEET-SOUR BEEF SPARERIBS**

SERVES 4

### **INGREDIENTS**

3 tablespoons vegetable oil  
3 lb lean short spareribs cut into serving pieces

### **Sweet-Sour Sauce Ingredients**

3 tablespoons soy sauce	2 tablespoons onion, minced
2 tablespoons brown sugar	2 tablespoons apricot marmalade
3 tablespoons honey	2 tablespoons cider vinegar
3 cloves garlic, minced	2 tablespoons dry sherry
1/4 cup ketchup	1 teaspoon hot pepper sauce, or to taste

### **DIRECTIONS**

- In a small bowl combine all the sauce ingredients. Heat the oil in the pressure cooker until very hot, add as many ribs at a time as will comfortably fit, and brown well. Pour off all fat, and then stir in the sauce. (Follow the Browning/Sautéing instructions on Page-14 of this manual.)
- Lock the lid in place and press the MEAT button. When cooking is complete, use the Quick release method and remove the lid.

# TRADITIONAL MEAT LOAF

SERVES 4

## **INGREDIENTS**

1 1/2 lb mixture of chopped or ground lean beef, pork and veal  
1 teaspoon salt  
Freshly ground pepper  
2 slices bread, soaked in water and squeezed dry  
2 tablespoons parsley  
1 medium onion, minced 1 garlic clove  
1 egg  
2 tablespoons chicken stock  
2 teaspoons Worcestershire sauce  
2 tablespoons olive oil  
1 cup tomato sauce  
1 cup water

## **DIRECTIONS**

- In a bowl, combine the chopped meat, salt, pepper, bread, parsley, onion, garlic, egg, chicken stock and Worcestershire sauce. Shape into two small loaves. Wrap each in wax paper and chill several hours to firm. Heat the oil in the pressure cooker and brown the loaves well on all sides. (Follow the Browning/Sautéing instructions on Page-14 of this manual.)
- Remove and set on oven-safe dish that will fit into the pressure cooker.
- Pour off the oil and combine the tomato sauce and water, and season with salt and pepper. Spread the ketchup over the meat loaves and lower the oven-safe dish into the pressure cooker.
- Lock the lid in place and press the MEAT button. When cooking is complete, use the Quick or Natural release method and remove the lid. Remove dish using a removing utensil/tool. Slice and serve.
- Lock the lid in place and press the MEAT button. When cooking is complete, use the Quick or Natural release method and remove the lid. Serve with rice if desired.

# JAMBALAYA

SERVES 4-6

## **INGREDIENTS**

1 tablespoon vegetable oil  
1/2 lb boneless skinless chicken breasts, cut into 1" pieces  
1/2 lb fully cooked Andouille or Italian sausage, sliced  
1/2 lb uncooked shrimp, peeled and deveined  
2 teaspoons Creole seasoning  
1 teaspoon dried thyme leaves  
1/8 teaspoon cayenne pepper 1 onion, chopped  
3 garlic cloves, minced  
1 green bell pepper, chopped  
3 stalks celery, sliced  
1 cup long grain rice  
16 oz canned chopped tomatoes, un-drained  
1 cup chicken stock  
3 tablespoons fresh parsley, minced

## **DIRECTIONS**

- Heat oil in the pressure cooker. Add chicken, sausage and shrimp. Sprinkle meats with half of the Creole seasoning, half the thyme and half the cayenne. Cook for 3-5 minutes uncovered, stirring frequently, until chicken and shrimp are thoroughly cooked. Remove chicken, sausage and shrimp with a slotted spoon and set aside. (Follow the Browning/Sautéing instructions on Page-14 of this manual.)
- Add onion, bell pepper, celery and remaining Creole seasoning, thyme and cayenne to pressure cooker. Cook for 4-5 minutes, stirring frequently. Add chicken, sauce, shrimp and rice, tomatoes with their juice and stock. (Follow the Browning/Sautéing instructions on Page-14 of this manual.)
- Lock the lid in place and press the SOUP & STEW button. When cooking is complete, use the Quick or Natural release method and remove the lid. Serve with rice if desired.

## CORNISH HENS BRAISED IN WHITE WINE

SERVES 4

### **INGREDIENTS**

2 tablespoons olive oil	1 tablespoon minced parsley
2 Cornish hens, trussed	1 tablespoon flour
1/2 teaspoon salt	1/2 cup dry white wine
1/4 teaspoon freshly ground black pepper	1/2 cup chicken stock
1/2 teaspoon thyme	1/4 lb mushrooms, cleaned and sliced
1/2 teaspoon basil	

### **DIRECTIONS**

- In the pressure cooker, heat the olive oil and brown the Cornish hens on all sides. Sprinkle them with salt and pepper, thyme, basil and parsley. Stir in the flour, and then pour in the wine and stock. (Follow the Browning/Sautéing instructions on Page-14 of this manual.)
  - Lock the lid in place and program to cook for 40-minutes. When cooking is complete, use the Quick or Natural release method and remove the lid. Serve with rice or a salad if desired.
- 

## ORANGE-FLAVORED CANDIED YAMS

SERVES 4

### *Ingredients*

1 cup orange juice	1/2 cup brown sugar
2 large sweet potatoes (yams)	1 teaspoon grated orange zest
Salt, to taste	2 tablespoons butter

### **DIRECTIONS**

- Pour the orange juice into the pressure cooker. Peel the sweet potatoes and cut them in half lengthwise. Arrange in a pressure cooker steamer basket (if available) and sprinkle with salt, brown sugar and orange zest. Dot with butter.
- Lower the steamer basket into the pressure cooker.
- Lock the lid in place and press the POTATOES & YAMS. When cooking is complete, use the Quick or Natural release method and remove the lid.
- Lift out the sweet potatoes.
- Boil down the sauce until thickened and pour over the sweet potatoes.



## CHICKEN TORTILLA SOUP

SERVES 8-10

### INGREDIENTS

1/3 cup vegetable oil  
2 onions, diced  
4 cloves garlic, peeled  
1 can tomatoes, drained  
3 quarts chicken broth

2 Cups Cooked Shredded Chicken  
Tortilla chips  
cilantro, chopped  
1 lb grated cheese  
lime wedges (optional)

### DIRECTIONS

- Sauté onions and garlic in the oil in the pressure cooker until they are deep golden brown. (Follow the Browning/Sautéing instructions on Page-14 of this manual.)
- Remove from unit and purée with tomatoes in blender or food processor until smooth.
- Return to pressure cooker and add broth. Heat to boiling.
- Lock the lid in place and press the SOUP & STEW button. When cooking is complete, use the Quick or Natural release method and remove the lid.
- Add cilantro and salt to taste. Place cheese and tortilla chips in individual soup bowls and pour hot soup on top. Serve with lime wedges, if desired.

## SPICED APPLE CRUNCH

SERVES 3

### INGREDIENTS

1 cup dry bread crumbs (unseasoned)  
1/4 cup sugar  
1/2 teaspoon cinnamon

1 lemon (juice and rind) 3 apples, sliced  
1/4 cup butter, melted  
2 cups water

### DIRECTIONS

- Butter a 15 cm (6") baking dish. Combine bread crumbs (or graham wafer crumbs), sugar, cinnamon, juice and lemon rind. Place alternate layers of apples and crumbs in baking dish. Pour melted butter over ingredients and cover baking dish firmly with aluminum foil.
- Place water, trivet, and then baking dish in pressure cooker.
- Lock the lid in place and program to cook for 20-minutes. When cooking is complete, use the Quick or Natural release method and remove the lid.
- If you wish to add more color and crunch, run the dish quickly under the broiler. Be sure to watch carefully to prevent burning.

# OLD FASHIONED RICE PUDDING

SERVES 4

## **INGREDIENTS**

1 tablespoon butter	1 egg
1/4 cup long grain rice	1/4 cup evaporated milk
2 cups milk	1/2 teaspoon vanilla
1 cup water	Cinnamon
1/3 sugar	1/2 teaspoon salt

## **DIRECTIONS**

- Melt the butter in the pressure cooker and stir in the rice, coating it with the butter. Pour in the fresh milk and water, and then stir in the sugar and salt. (Follow the Browning/Sautéing instructions on Page-14 of this manual.)
- Lock the lid in place and program to cook for 10-minutes. When cooking is complete, use the Quick or Natural release method and remove the lid.
- In a small bowl mix together the egg, evaporated milk and vanilla. Stir in a little of the hot liquid from the pressure cooker, then add the mixture to the pressure cooker.
- When cooking is complete, use the Quick or Natural release method and remove the lid.
- Cover again and set to cook for 5 more minutes.
- When cooking is complete, use the Quick or Natural release method and remove the lid.
- Cool 10 minutes, stirring occasionally.
- Transfer to individual dessert bowls, continue cooling, then refrigerate. Serve sprinkled with cinnamon.

# PEARS STEWED IN RED WINE

SERVES 4

## **INGREDIENTS**

2 cups water

1/2 cup sugar

2 slices lemon

2 cinnamon sticks

1/4 teaspoon mace

4 firm pears, peeled but not cored, stems on

3/4 cup red wine

1 cup frozen raspberries

4 tablespoons heavy cream

## **DIRECTIONS**

- In the pressure cooker, combine the water, sugar, lemon, cinnamon sticks and mace. Simmer until the sugar is dissolved. (Follow the Browning/Sautéing instructions on Page-14 of this manual.)
- Place the pears into the pressure cooker, trimming bottoms if necessary so they stand upright.
- Lock the lid in place and program to cook for 10-minutes. When cooking is complete, use the Quick or Natural release method and remove the lid.
- Add the red wine.
- Lock the lid in place again and program to cook for 10 more minutes. When cooking is complete, use the Quick or Natural release method and remove the lid.
- Carefully remove only the pears and transfer to a deep container.
- Boil down the remaining sauce until it is syrupy by pressing BROWN / WILD RICE button. Cool, then pour over the pears and keep at room temperature overnight.
- To serve, defrost and purée the raspberries in a processor until smooth.
- Spoon 4 tablespoons of the purée on four dessert dishes or shallow bowls. Place a pear upright in the center of each dish. Spoon some syrup over the pears.
- Dribble 1 tablespoon of cream in a circle over the sauce. With the aid of a knife, swirl the cream into the sauce in an attractive design.

# CINNAMON APPLE FLAN WITH MAPLE SYRUP

SERVES 6

## **INGREDIENTS**

5 tablespoons maple syrup	1/4 teaspoon vanilla
1/4 teaspoon cinnamon	6 tablespoons sugar
2 apples, peeled and cut in 1/4" slices	2 1/2 cups milk
3 whole eggs 3 egg yolks	

## **DIRECTIONS**

- In a small saucepan, combine the maple syrup and the cinnamon. Add the apple slices and slowly simmer until the apples are tender.
- Divide the mixture into 6 greased oven-safe custard cups. In a large bowl, whisk the eggs and egg yolks. Stir in the vanilla, sugar and milk. Pour this mixture slowly into the custard cups. Cover tightly with foil.
- Fill the pressure cooker with 2 1/2 cups water. Place as many custard cups as will fit in the pressure cooker steamer basket (if available) and lower into the pressure cooker.
- Lock the lid in place again and program to cook for 10 minutes. When cooking is complete, use the Natural release method and remove the lid.
- Remove the lid, take out the basket, loosen the foil and cool the custard.
- Refrigerate. To serve, loosen the custard from the molds with a knife and invert onto dessert dishes.

### **LIMITED WARRANTY\* ONE (1) YEAR:**

Your small kitchen appliance is warranted to the original purchaser to be free from any manufacturing defects under normal use and conditions for one (1) year, cord excluded. During that period, should the appliance fail to operate properly, return the appliance with your sales receipt to the store where purchased. If you use your appliance for household use and according to instructions, it should give you years of satisfactory service. This product warranty covers only the original consumer purchase of the product.

### **WARRANTY IS ONLY VALID WITH A DATED PROOF OF PURCHASE.**

To guarantee repair or replacement without charge, a dated sales receipt showing purchase within the limited warranty period\* must accompany the appliance. Without a sales receipt, warranty will be estimated according to the appliance's manufactured date. A comparable appliance should arrive within 2-3 weeks. However, in case an appliance is not covered by warranty, correspondence offering alternatives will be mailed to you. During the limited one-year warranty period, a product with a defect will be either repaired or replaced with a comparable reconditioned model (at our option) when the product is returned to our Service Center. (See the "Returns" section below). The repaired or replacement product will be in warranty for the remaining balance of the limited one-year warranty period and an additional one-month (30 day) period.

\*One Year Limited Warranty valid only **within the United States plus the District of Columbia, excluding Puerto Rico and the Virgin Islands and does NOT cover:**

- Damages caused by unreasonable use, neglect, normal wear and tear, commercial use, improper assembly or installation of product.
- Damages caused in shipping.
- Damages caused by replacement or resetting of house fuses or circuit breakers.
- Defects other than manufacturing defects.
- Breakage caused by misuse, abuse, accident, alteration, lack of proper care and maintenance, or incorrect current or voltage.
- Lost or missing parts of the product. Parts will need to be purchased separately.
- Damages of parts that are not electrical; for example: cracked or broken plastic or glass.
- Damage from service or repair by unauthorized personnel.
- Extended warranties purchased via a separate company or reseller.
- Consumer's remorse is not an acceptable reason to return a product to our Service Center.

\*The consumer is responsible for any delivery charges for all replacement units provided for exchange under the warranty.

**RETURNS:** Any return of defective merchandise to the manufacturer must be processed accordingly by contacting customer service first to obtain an RA # (Return Authorization Number). We will not accept any returns of merchandise without an applicable RA #.

We cannot assume responsibility for loss or damages to products returned to us during incoming shipment. For your protection, always carefully package the product for shipment and insure with the carrier. Be sure to enclose the following items with your return: any accessories related to the problem, your full address and daytime phone number, a note describing the problem, a copy of the dated sales receipt or other proof of purchase and a valid RA#.

C.O.D shipments cannot be accepted.

\*One Year Limited Warranty valid only **within the United States plus the District of Columbia, excluding Puerto Rico and the Virgin Islands.**

This warranty is effective only if the product is purchased and operated in the USA; product usage which is in violation of the written instructions provided with the unit will void this warranty.

For international warranty, please contact the local distributor.

\*\*Any instruction or policy included in this manual may be subject to change at any time.

**Model EPC-608**

*Elite Platinum*<sup>®</sup> **6Qt. Digital Pressure Cooker**

### **MAXI-MATIC<sup>®</sup>, USA**

18401 E. Arenth Ave. City of Industry, CA 91748

Customer Service Dept: (626) 912-9877 Ext: 107 / 120 MON-FRI 9am-5pm PST

Email: [info@maxi-matic.com](mailto:info@maxi-matic.com)

Website: [www.maxi-matic.com](http://www.maxi-matic.com)