



Better solutions through innovation

## Owner's Manual

Model

DWF3651

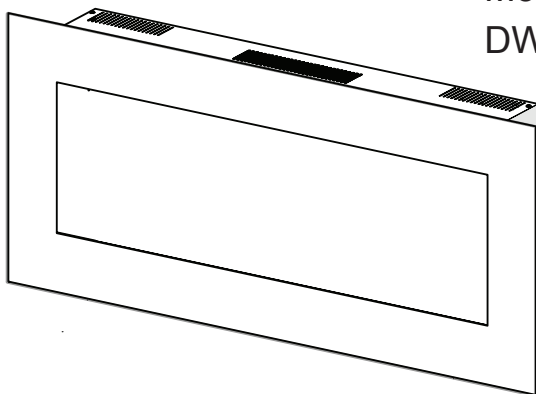

---









**IMPORTANT SAFETY INFORMATION:** Always read this manual first before attempting to install or use this fireplace. For your safety, always comply with all warnings and safety instructions contained in this manual to prevent personal injury or property damage.

To view the full line of Dimplex products, please visit [www.dimplex.com](http://www.dimplex.com)

7214040100R01



## Table of Contents

 Welcome & Congratulations . . . . .	3
 IMPORTANT INSTRUCTIONS . . . . .	4
 Quick Reference Guide . . . . .	6
 Fireplace Installation . . . . .	7
 Operation . . . . .	11
 Maintenance . . . . .	14
 Warranty . . . . .	15
 Replacement Parts . . . . .	17

Always use a qualified technician or service agency to repair this fireplace.

**! NOTE:** Procedures and techniques that are considered important enough to emphasize.

**⚠ CAUTION:** Procedures and techniques which, if not carefully followed, will result in damage to the equipment.

**⚠ WARNING:** Procedures and techniques which, if not carefully followed, will expose the user to the risk of fire, serious injury, or death.

## Welcome & Congratulations

Thank you and congratulations for purchasing an electric fireplace from Dimplex. Please use our convenient online registration page to record your model and serial numbers for future reference at

[www.dimplex.com/register](http://www.dimplex.com/register)

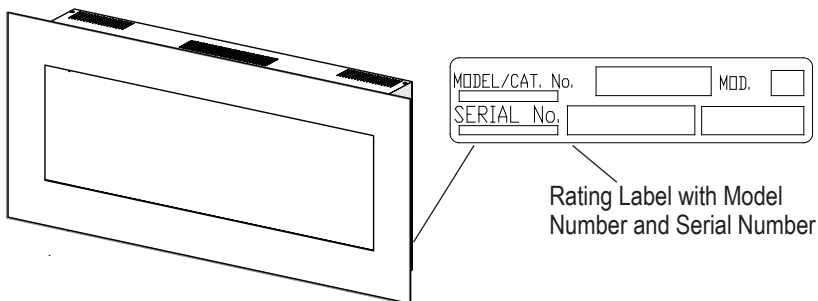

Rating Label with Model Number and Serial Number

**Please carefully read and save these instructions.**

**⚠ CAUTION:** Read all instructions and warnings carefully before starting installation. Failure to follow these instructions may result in a possible electric shock, fire hazard and will void the warranty.



**NO NEED TO RETURN TO THE STORE**

Questions with operation or assembly? Require Parts Information?  
Product Under Manufacturer's Warranty?

Contact us at:  [www.dimplex.com/customer\\_support](http://www.dimplex.com/customer_support)  
For Troubleshooting and Technical Support

OR  **Toll-Free 1-888-DIMPLEX (1-888-346-7539)**

Monday to Friday 8:00 a.m. to 4:30 p.m. EST

*In order to better serve you, please have your model and serial number ready or register your product online before calling (See above)*

# IMPORTANT INSTRUCTIONS

When using electrical appliances, basic precautions should always be followed to reduce the risk of fire, electric shock, and injury to persons, including the following:

- ① Read all instructions before using the electric fireplace.
- ② This fireplace is hot when in use. To avoid burns, do not let bare skin touch hot surfaces. The trim around the heater outlet becomes hot during heater operation.
- ③ Extreme caution is necessary when any heater is used by or near children or invalids and whenever the unit is left operating and unattended.
- ④ Always unplug the fireplace when not in use.
- ⑤ Young children should be supervised to ensure that they do not play with the appliance.
- ⑥ The appliance is not intended for use by young children or infirmed persons without supervision.
- ⑦ If the supply cord is damaged, it must be replaced by the manufacturer, or its service agent, or a qualified person in order to avoid a hazard.
- ⑧ Do not operate any unit with a damaged cord or plug, or if the heater has malfunctioned, or if the electric fireplace has been dropped or damaged in any manner, contact Dimplex Technical Service at 1-888-346-7539.
- ⑨ Do not use outdoors.
- ⑩ This fireplace is not intended for use in bathrooms, laundry areas and similar indoor locations. Never locate heater where it may fall into a bathtub or other water container.
- ⑪ High temperature, keep electrical cords, drapery, and other furnishings at least 3 feet (0.9m) from the front of the heater and away from the side and rear.
- ⑫ Do not run the cord under carpeting. Do not cover cord with throw rugs, runners, or the like. Arrange cord away from traffic area and where it will not be tripped over.
- ⑬ Do not locate the unit directly below a fixed electrical convenience outlet.
- ⑭ To disconnect the fireplace, turn the controls off, then remove the plug from the outlet.
- ⑮ Do not insert or allow foreign objects to enter any ventilation or exhaust opening as this may cause an electric shock or fire, or damage to the heater.
- ⑯ Do not block air intake or

# IMPORTANT INSTRUCTIONS

exhaust in any manner. Do not use on soft surfaces, like a bed, where openings may become blocked.

⑰ All electrical heaters have hot and arcing or sparking parts inside. Do not use in areas where gasoline, paint, or flammable liquids are used or stored or where the unit will be exposed to flammable vapors.

⑱ Do not modify the electric fireplace. Use it only as described in this manual. Any other use not recommended by the manufacturer may cause fire, electric shock or injury to persons.

⑲ Avoid the use of an extension cord. Extension cords may overheat and cause a risk of fire. This heater is not intended for use with an extension cord. Plug the cord directly into an appropriate wall receptacle.

⑳ Do not burn wood or other materials in the electric fireplace.

㉑ Do not strike the fireplace glass.

㉒ Always use a certified electrician

should new circuits or outlets be required.

㉓ Always use properly grounded, fused and polarized outlets.

㉔ Disconnect all power supply before performing any cleaning, maintenance or relocation of the unit.

㉕ When transporting or storing the unit and cord, keep in a dry place, free from excessive vibration and store so as to avoid damage.

 **WARNING:** Remote control contains a small battery. Keep away from children. If swallowed, seek medical attention immediately.

 **WARNING:** Do not install battery backwards, charge, put in fire or mix with used or other battery types - may explode or leak causing injury.

**! NOTE:** Changes or modifications not expressly approved by the party responsible for compliance could void user's authority to operate the equipment.



**CAUTION**  
RISK OF ELECTRIC SHOCK  
DO NOT OPEN  
NO USER-SERVICABLE PARTS INSIDE



## SAVE THESE INSTRUCTIONS



## Quick Reference Guide

1. Before using the fireplace verify the circuit breakers for the unit on?
2. If you have any technical questions or concerns regarding the operation of your electric fireplace, or require service, contact customer service.
3. The heater may emit a slight, harmless odor when first used. This odor is a normal condition caused by the initial heating of internal heater parts.
4. For dimensions of your fireplace, refer to Figure 1.

Figure 1

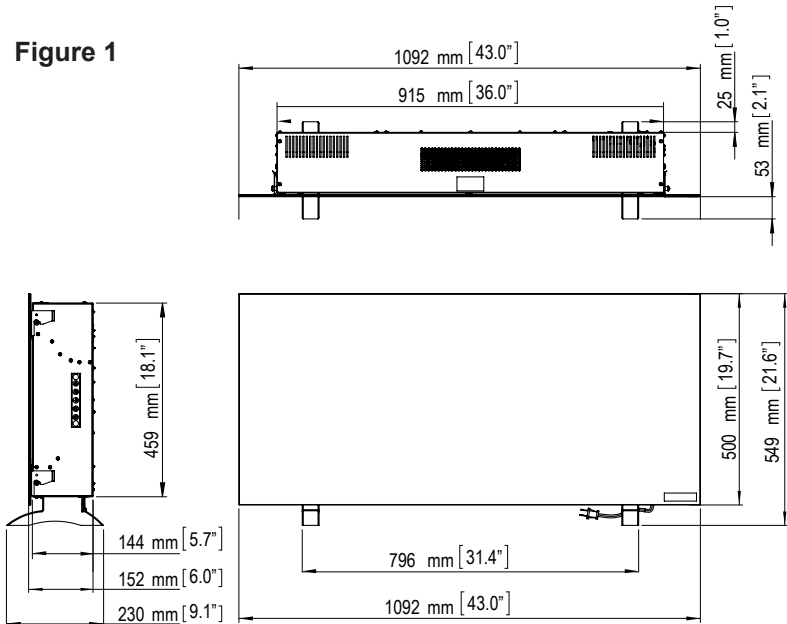

**! NOTE:** The use of feet are optional.

# Fireplace Installation

## Site Selection

The unit is packaged with two types of mounting options:

- Wall mounting, Surface
- Support feet, table top

**! NOTE:** A 15 Amp, 120 Volt circuit is required. A dedicated circuit is preferred but not essential in all cases. A dedicated circuit will be required if, after installation, the circuit breaker trips or the fuse blows on a regular basis when the heater is operating. Additional appliances on the same circuit may exceed the current rating of the circuit breaker.

**⚠ WARNING:** Ensure the power cord is not installed so that it is pinched or against a sharp edge and ensure that the power cord is stored or secured to avoid tripping or snagging to reduce the risk of fire, electric shock or injury to persons.

Construction and electrical outlet wiring must comply with local building codes and other applicable regulations to reduce the risk of fire, electric shock and injury to persons.

Do not attempt to wire your own new outlets or circuits. To reduce the risk of fire, electric

shock or injury to persons, always use a licensed electrician.

**⚠ WARNING:** The supplied mounting bracket is designed for use with Dimplex wall mounted fireplaces only. Improper use, or use for purposes other than intended, may cause damage or injury.

## Wall Mounting Instructions

**⚠ WARNING:** Failure to install the fireplace as instructed below may result in damage to the equipment and or may expose the user to the risk of fire, serious injury, illness or death.

**⚠ WARNING:** The fireplace requires the wall mounting bracket screws to be installed into a minimum of two wall studs (Figure 2).

## Tools Required

- #2 Phillips screwdriver
- Pencil
- Slot screwdriver
- Bubble level (supplied)
- Drill, and drill bits as required

**Approximate time:** 30 minutes for installation

1. Select an appropriate location

## Fireplace Installation

to mount the unit on a wall, above an electrical outlet. Access to the electrical outlet must be maintained. Ensure the installation meets the national and state/provincial electrical codes.

**! NOTE:** It is recommended that the bottom of the unit not be mounted higher than 1020mm (40") from the Fireplace Installation ground to maintain an optimized viewing angle of the flame.

**! CAUTION:** Ensure that the top of the unit is at least 610mm (24") from the ceiling or any object (i.e. Electrical receptacles) that may obstruct or be susceptible the flow or temperature of air out of the unit.

**! CAUTION:** High temperature, keep electrical cords, drapery, and other furnishings at least 3 feet (0.9m) from the front of the heater and away from the side and rear.

2. The wall-mounting bracket must be mounted to at least 2 wall studs. Studs should be accessed through 2 wall-bracket holes in one of the following combinations: A&F, B&D, or C&E (Figure 2).

**Figure 2**

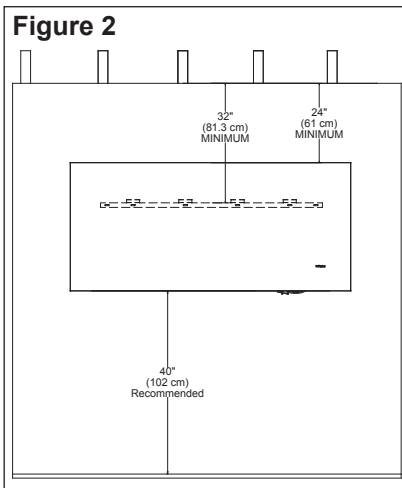

**Figure 3**

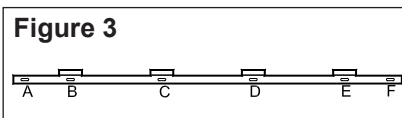

**! NOTE:** Wall anchors must be installed in the appropriate wall locations to fasten the wall bracket through the remaining holes (Figure 3). For example, if you plan to secure the bracket to studs through holes A&D, install anchors centered on holes B & C.

3. Hold the wall-mounting bracket on the wall and mark the location of 1 of the mounting holes.
4. Place the bubble level onto the top of the wall-mounting



## Fireplace Installation

bracket.

- Adjust the wall-mounting bracket so the bubble on the level is centered between the two black lines.
- Mark 3 other mounting screw locations, on the wall, ensuring that the wall bracket stays level.
- Install the supplied wall anchors on the drywall marked locations by placing a #2 Phillips screwdriver into the recess of the anchor.
- Press the anchor into the wall in the desired marked position while turning the anchor clockwise until it is flush with the wall.
- Insert the wall anchor screws through the wall bracket and thread into the wall anchors. Tighten the screw (Figure 4).

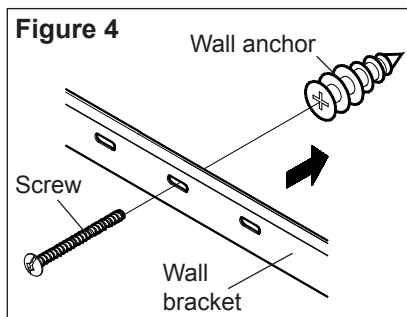

**Figure 5**

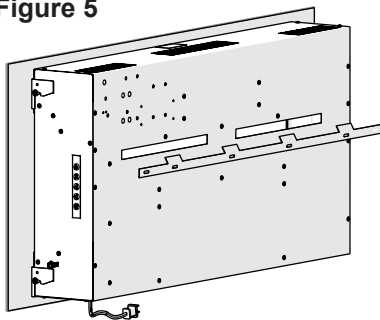

- Install the remaining screws through the bracket and into the wall studs as required.

**! NOTE:** At least two of the mounting screws must be installed into a wall stud.

- Mount the unit on the wall, so that the tabs on the wall bracket have been inserted into the slots on the back of the firebox, as shown. (Figure 5)
- Carefully pour and evenly distribute the supplied glass rock media in the Media tray of the firebox (Figure 6).
- Hang the front glass assembly on the mounts of the firebox and secure the glass onto the unit by installing the retaining screws (Figure 7).
- Excess electrical cord can be

## Fireplace Installation

inserted back into the bottom of the unit, into the cord storage area.

### Support Feet Installation Instructions

1. Remove unit from packaging and place open side up on a flat working surface.
2. Secure the two support feet to the bottom of the unit using the supplied screws.
3. Turn the unit upright.
4. Attach the provided cover plates over the two hanging bracket openings on the back of the unit, with the provided screws (Figure 8).
5. Carefully pour and evenly distribute the supplied glass rock media in the Media tray of the firebox (Figure 6).
6. Hang the front glass assembly on the mounts of the firebox and secure the glass onto the unit by installing the retaining screws (Figure 7)
7. Excess electrical cord can be inserted back into the bottom of the unit, into the cord storage area.

**Figure 6**

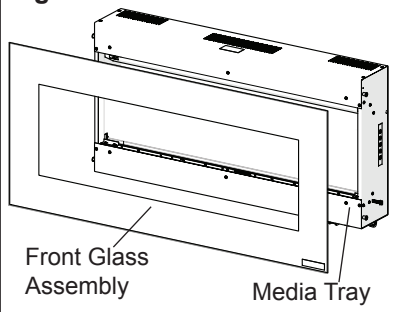

**Figure 7**

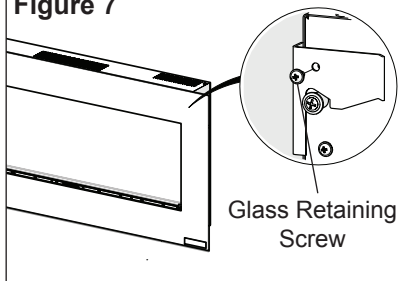

**Figure 8**

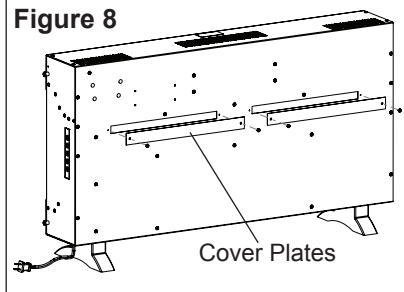

## 🔑 Operation

Figure 9

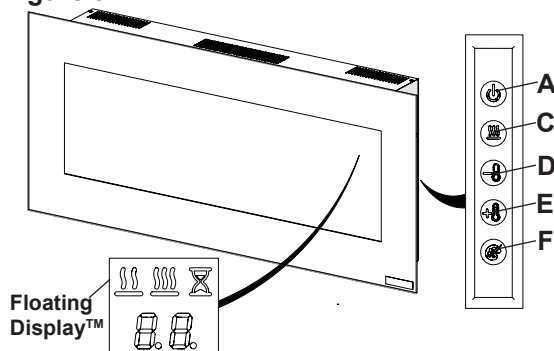
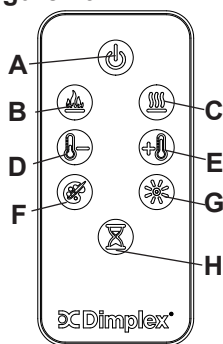

Figure 10



The unit can be controlled by either the manual controls which are located on the right side of the fireplace or the remote (Figure 9 & 10).

The fireplace is supplied with an IR multifunction remote control.

**! NOTE:** To operate correctly, the remote control must be pointed towards the Floating Display™.

**! NOTE:** Before attempting any operation with the remote, pull the plastic insulator strip out from between the remote casing and battery cover.

### A. Standby

Turns the unit On and Off.

→ Activated by pressing the Standby button on the remote or the unit.

- The unit will turn on with the

same functions that it was set to when it was turned Off and the intake temperature will be indicated on the On Screen Display.

**! NOTE:** If the unit is turned off when the flame effect is Off, when the unit is turned back on the flame will be restored.

**! NOTE:** When any button is pressed the intake temperature will be displayed on the On Screen Display for 5 seconds.

### B. Flame Effects

Turns the flame effect On and Off.

→ Activated by pressing the  button on the remote.



### C. Heat ON/OFF

Cycles the unit sequentially through the 3 settings: Low Heat,



## Operation

High Heat and Off.

→ Activated by pressing the  button on the unit or the remote.

- Indicated by the  (low heat) or the  (high heat) icon and the intake temperature being displayed on the On Screen Display, for 5 seconds before turning off.



**! NOTE:** After the heater is switched off, there is a 60 second fan delay, where the fan will continue running before turning off.

**! NOTE:** The unit can be operated in **Heat Only Mode**. When the unit is only running with the heater, the  (low heat) or the  (high heat) icon and the intake temperature will continuously be displayed on the On Screen Display.



**! NOTE:** The heater may emit a slight, harmless odor when first used. This odor is a normal condition caused by initial heating of internal heater parts and will not occur again.

**D & E.**  **Thermostat Controls**  
Adjusts the temperature set point to your individual requirements.

Once the desired set temperature is reached the heater will turn off. The heater will cycle on and off to maintain the desired set temperature. The default temperature setting is 72°F (22°C).



→ Adjusted by pressing the  to decrease the setpoint and the  to increase the setpoint on the remote.

- The On Screen Display will indicate the temperature setpoint as it is adjusted.

**! NOTE:** Holding the  button down, then press  on the unit, will change the temperature from °C to °F, or vice versa.

### **Disable Heat**

If desired, depending on the season, the heater on the unit can be disabled. The unit will operate in the same fashion, with remainder of the controls.

Pressing the  and  buttons on the unit at the same time and holding for 2 seconds will disable and enable the heater.

**! NOTE:** When the heater has been disabled and either the 

## Operation

or the  is pressed the On Screen Display will indicate "--".

### F. Color Themes

Different presets of ambient lighting color combinations contained in the unit.

- Changed by repeatedly pressing the corresponding button on the remote or the unit.
- Cycles through the different preset ambient lighting settings of the unit, this includes different combinations of colours of the top lighting, flame base and media lighting (if applicable).

**! NOTE:** The last theme of the cycle is a prism where the unit cycles through a variety of colours.

Pressing the  button stops the cycling and holds the unit on the preferred color, indicated by a solid circle. When the unit is on prism, and is cycling through the colours, a rotating circle will be displayed.

### G. Brightness

Changes the brightness of the lights in the unit.

- Adjusted by repeatedly pressing the corresponding button on the remote.

- Indicated by the second digit on the Floating Display™ changing to show: "H" (high), and "L" (low).

### H. Sleep Timer

The Sleep Timer can be set to automatically shut off the fireplace after a preset time (from 30 minutes to 8 hours).

- To set the timer press the timer button on the remote, repeatedly, until the desired time is displayed.
- The On Screen Display will display the different times as it is adjusted. Once the timer has begun, pressing the  button will display the time remaining before the unit turns Off.

**! NOTE:** The Sleep Timer can be cancelled at any time by pressing the  button repeatedly until the sleep timer displays nothing.

### Resetting the Temperature Cutoff Switch

Should the heater overheat, an automatic cut out will turn the heater off and it will not come back on without being reset. It can be reset by unplugging the

## Operation

unit and waiting 5 minutes before plugging the unit back in.

**⚠ CAUTION:** If you need to continuously reset the heater, unplug the unit and call technical support at 1-888-346-7539.

### Remote Control Battery Replacement

To replace the battery:

1. Slide battery cover open on

the remote control. Correctly install one 3 Volt (CR2032 [longer life] or CR2025) battery in the battery holder.

2. Close the battery cover.



Battery must be recycled or disposed of properly. Check with your Local Authority or Retailer for recycling advice in your area



## Maintenance

**⚠ WARNING:** Disconnect power before attempting any maintenance or cleaning to reduce the risk of fire, electric shock or damage to persons.

### Partially Reflective Glass Cleaning

The Partially Reflective Glass is cleaned in the factory during the assembly operation. During shipment, installation, handling, etc., the Partially Reflective Glass may collect dust particles; these can be removed by dusting lightly with a clean dry cloth.

To remove fingerprints or other marks, the Partially Reflective Glass can be cleaned with

a damp cloth. The Partially Reflective Glass should be completely dried with a lint free cloth to prevent water spots. To prevent scratching, do not use abrasive cleaners.

### Fireplace Surface Cleaning

Use only a damp cloth to clean painted surfaces of the fireplace. Do not use abrasive cleaners.

### Servicing

Except for installation and cleaning described in this manual, an authorized service representative should perform any other servicing.



## Warranty

### *Products to which this limited warranty applies*

This limited warranty applies to the following models of your newly purchased Dimplex electric fireplace **DWF3651**. This limited warranty applies only to purchases made in any province of Canada except for Yukon Territory, Nunavut, or Northwest Territories or in any of the 50 States of the USA (and the District of Columbia) except for Hawaii and Alaska. This limited warranty applies to the original purchaser of the product only and is not transferable.

### *Products excluded from this limited warranty*

Products purchased in Yukon Territory, Nunavut, Northwest Territories, Hawaii, or Alaska are not covered by this limited warranty. Products purchased in these States, provinces, or territories are sold AS IS without warranty or condition of any kind (including, without limitation, any implied warranties or conditions of merchantability or fitness for a particular purpose) and the entire risk of as to the quality and performance of the products is with the purchaser, and in the event of a defect the purchaser assumes the entire cost of all necessary servicing or repair.

### *What this limited warranty covers and for how long*

Products, other than fireplace surrounds (mantels) and trims, covered by this limited warranty have been tested and inspected prior to shipment and, subject to the provisions of this warranty, Dimplex warrants such products to be free from defects in material and workmanship for a period of 1 year from the date of the first purchase of such products.

The limited 1 year warranty period also applies to any implied warranties that may exist under applicable law. Some jurisdictions do not allow limitations on how long an implied warranty lasts, so the above limitation may not apply to the purchaser.

### *What this limited warranty does not cover*

This limited warranty does not apply to products that have been repaired (except by Dimplex or its authorized service representatives) or otherwise altered. This limited warranty does further not apply to defects resulting from misuse, abuse, accident, neglect, incorrect installation, improper maintenance or handling, or operation with an incorrect power source.

### *What you must do to get service under this limited warranty*

Defects must be brought to the attention of Dimplex Technical Service by contacting Dimplex at 1-888-DIMPLEX (1-888-346-7539), or 1367 Industrial Road, Cambridge Ontario, Canada N1R 7G8. Please have proof of purchase, catalogue/model and serial numbers available when calling. Limited warranty service requires a proof of purchase of the product.

### *What Dimplex will do in the event of a defect?*

In the event a product or part covered by this limited warranty is proven to be defective in material or workmanship during the 1 year limited warranty period you have the following rights:

- Dimplex will in its sole discretion either repair or replace such defective product or part without charge. If Dimplex is unable to repair or replace such product or part, or if repair or



## Warranty

replacement is not commercially practicable or cannot be timely made, Dimplex may, in lieu of repair or replacement, choose to refund the purchase price for such product or part.

- Limited warranty service will be performed solely by dealers or service agents of Dimplex authorized to provide limited warranty services.
- Dimplex will not be responsible for, and the limited warranty services shall not include, any expense incurred for installation or removal of the product or part (or any replacement product or part) or any labour or transportation costs. Such costs shall be the purchaser's responsibility.

*What Dimplex and its dealers and service agents are also not responsible for:*

IN NO EVENT WILL DIMPLEX, OR ITS DIRECTORS, OFFICERS, OR AGENTS, BE LIABLE TO THE PURCHASER OR ANY THIRD PARTY, WHETHER IN CONTRACT, IN TORT, OR ON ANY OTHER BASIS, FOR ANY INDIRECT, SPECIAL, PUNITIVE, EXEMPLARY, CONSEQUENTIAL, OR INCIDENTAL LOSS, COST, OR DAMAGE ARISING OUT OF OR IN CONNECTION WITH THE SALE, MAINTENANCE, USE, OR INABILITY TO USE THE PRODUCT, EVEN IF DIMPLEX OR ITS DIRECTORS, OFFICERS, OR AGENTS HAVE BEEN ADVISED OF THE POSSIBILITY OF SUCH LOSSES, COSTS OR DAMAGES, OR IF SUCH LOSSES, COSTS, OR DAMAGES ARE FORESEEABLE. IN NO EVENT WILL DIMPLEX, OR ITS OFFICERS, DIRECTORS, OR AGENTS BE LIABLE FOR ANY DIRECT LOSSES,

COSTS, OR DAMAGES THAT EXCEED THE PURCHASE PRICE OF THE PRODUCT.

SOME JURISDICTIONS DO NOT ALLOW THE EXCLUSION OR LIMITATION OF INCIDENTAL OR CONSEQUENTIAL DAMAGES, SO THE ABOVE LIMITATION OR EXCLUSION MAY NOT APPLY TO THE PURCHASER.

### *How State and Provincial law apply*

This limited warranty gives you specific legal rights, and you may also have other rights which vary from jurisdiction to jurisdiction. The provisions of the United Nations Convention on Contracts for the Sale of Goods shall not apply to this limited warranty or the sale of products covered by this limited warranty.





## Replacement Parts

Heater Assembly (with Cutout) . . . . .	2203610400RP
Front Glass . . . . .	5902440100RP
Partially Reflective Glass . . . . .	5902420100RP
Power Cord . . . . .	4100010900RP
Flicker Motor . . . . .	2000500100RP
Flicker Rod . . . . .	5901070200RP
Mounting Hardware Kit . . . . .	9600350100RP
Mounting Bracket . . . . .	1017130259RP
Display/ Control Board . . . . .	3001430200RP
Switchboard . . . . .	3001520100RP
Relay Board . . . . .	3001440200RP
AC/DC Adapter . . . . .	2100250100RP
Remote Control . . . . .	6700520200RP
Thermistor . . . . .	3001560100RP
Surface Mount Hardware Kit . . . . .	9601410100RP
Acrylic Media . . . . .	1400150100RP
Media LED Set (RGB) . . . . .	9601180100RP
Flame LED Light Assembly (Amber) . . . . .	3001420200RP
Flame LED Light Assembly (RGB) . . . . .	3001570200RP



**Dimplex North America Limited**  
1367 Industrial Road  
Cambridge ON  
Canada N1R 7G8

© 2015 Dimplex North America Limited