

*If you have questions or comments, contact us.  
Pour toute question ou tout commentaire, nous contacter.  
Si tiene dudas o comentarios, contáctenos.*

**1-800-4-DEWALT • [www.dewalt.com](http://www.dewalt.com)**

**INSTRUCTION MANUAL  
GUIDE D'UTILISATION  
MANUAL DE INSTRUCCIONES**

INSTRUCTIVO DE OPERACIÓN, CENTROS DE SERVICIO Y PÓLIZA DE GARANTÍA. **ADVERTENCIA:** LÉASE ESTE INSTRUCTIVO ANTES DE USAR EL PRODUCTO.



DC820, DC822, DC830, DC840 1/2" (13 mm) Cordless Impact Wrench  
DC825, DC827, DC835, DC845, DC855, DCF826 1/4" (6.35 mm) Cordless Impact Driver  
DC823, DC833, DC841 3/8" (9.5 mm) Cordless Impact Wrench / DC821, DW059, DW059H 18 V 1/2" (13 mm) Cordless Impact Wrench  
Clé à chocs sans fil DC820, DC822, DC830, DC840 13 mm (1/2 po) / Mandrin à chocs sans fil DC825, DC827, DC835, DC845, DC855, DCF826 6,35 mm (1/4 po) / Clé à chocs sans fil DC823, DC833, DC841 9,5 mm (3/8 po) / Clé à chocs sans fil DC821, DW059, DW059H 18 V 13 mm (1/2 po)  
Llave de impacto inalámbrica DC820, DC822, DC830, DC840 de 13 mm (1/2") / Destornillador de impacto inalámbrico DC825, DC827, DC835, DC845, DC855, DCF826 de 6,35 mm (1/4") / Llave de impacto inalámbrica DC823, DC833, DC841 de 9,5 mm (3/8") / Llave de impacto inalámbrica DC821, DW059, DW059H de 18 V y 13 mm (1/2")

**Definitions: Safety Guidelines**

The definitions below describe the level of severity for each signal word. Please read the manual and pay attention to these symbols.

- ⚠ DANGER:** Indicates an imminently hazardous situation which, if not avoided, **will** result in **death or serious injury**.
- ⚠ WARNING:** Indicates a potentially hazardous situation which, if not avoided, **could** result in **death or serious injury**.
- ⚠ CAUTION:** Indicates a potentially hazardous situation which, if not avoided, **may** result in **minor or moderate injury**.
- NOTICE:** Indicates a practice **not related to personal injury** which, if not avoided, **may** result in **property damage**.

IF YOU HAVE ANY QUESTIONS OR COMMENTS ABOUT THIS OR ANY DEWALT TOOL, CALL US TOLL FREE AT: **1-800-4-DEWALT (1-800-433-9258)**.



**WARNING:** To reduce the risk of injury, read the instruction manual.

**General Power Tool Safety Warnings**

**⚠ WARNING! Read all safety warnings and all instructions.** Failure to follow the warnings and instructions may result in electric shock, fire and/or serious injury.

**SAVE ALL WARNINGS AND INSTRUCTIONS FOR FUTURE REFERENCE**

The term "power tool" in the warnings refers to your mains-operated (corded) power tool or battery-operated (cordless) power tool.

**1) WORK AREA SAFETY**

- a) **Keep work area clean and well lit.** Cluttered or dark areas invite accidents.
- b) **Do not operate power tools in explosive atmospheres, such as in the presence of flammable liquids, gases or dust.** Power tools create sparks which may ignite the dust or fumes.
- c) **Keep children and bystanders away while operating a power tool.** Distractions can cause you to lose control.

**2) ELECTRICAL SAFETY**

- a) **Power tool plugs must match the outlet. Never modify the plug in any way. Do not use any adapter plugs with earthed (grounded) power tools.** Unmodified plugs and matching outlets will reduce risk of electric shock.
- b) **Avoid body contact with earthed or grounded surfaces such as pipes, radiators, ranges and refrigerators.** There is an increased risk of electric shock if your body is earthed or grounded.
- c) **Do not expose power tools to rain or wet conditions.** Water entering a power tool will increase the risk of electric shock.
- d) **Do not abuse the cord. Never use the cord for carrying, pulling or unplugging the power tool. Keep cord away from heat, oil, sharp edges or moving parts.** Damaged or entangled cords increase the risk of electric shock.
- e) **When operating a power tool outdoors, use an extension cord suitable for outdoor use.** Use of a cord suitable for outdoor use reduces the risk of electric shock.
- f) **When operating a power tool in a damp location is unavoidable, use a ground fault circuit interrupter (GFCI) protected supply.** Use of a GFCI reduces the risk of electric shock.

### 3) PERSONAL SAFETY

- a) **Stay alert, watch what you are doing and use common sense when operating a power tool. Do not use a power tool while you are tired or under the influence of drugs, alcohol or medication.** A moment of inattention while operating power tools may result in serious personal injury.
- b) **Use personal protective equipment. Always wear eye protection.** Protective equipment such as dust mask, non-skid safety shoes, hard hat, or hearing protection used for appropriate conditions will reduce personal injuries.
- c) **Prevent unintentional starting. Ensure the switch is in the off position before connecting to power source and/or battery pack, picking up or carrying the tool.** Carrying power tools with your finger on the switch or energizing power tools that have the switch on invites accidents.
- d) **Remove any adjusting key or wrench before turning the power tool on.** A wrench or a key left attached to a rotating part of the power tool may result in personal injury.
- e) **Do not overreach. Keep proper footing and balance at all times.** This enables better control of the power tool in unexpected situations.
- f) **Dress properly. Do not wear loose clothing or jewelry. Keep your hair, clothing and gloves away from moving parts.** Loose clothes, jewelry or long hair can be caught in moving parts.
- g) **If devices are provided for the connection of dust extraction and collection facilities, ensure these are connected and properly used.** Use of dust collection can reduce dust-related hazards.

### 4) POWER TOOL USE AND CARE

- a) **Do not force the power tool. Use the correct power tool for your application.** The correct power tool will do the job better and safer at the rate for which it was designed.
- b) **Do not use the power tool if the switch does not turn it on and off.** Any power tool that cannot be controlled with the switch is dangerous and must be repaired.
- c) **Disconnect the plug from the power source and/or the battery pack from the power tool before making any adjustments, changing accessories, or storing power tools.** Such preventive safety measures reduce the risk of starting the power tool accidentally.
- d) **Store idle power tools out of the reach of children and do not allow persons unfamiliar with the power tool or these instructions to operate the power tool.** Power tools are dangerous in the hands of untrained users.
- e) **Maintain power tools. Check for misalignment or binding of moving parts, breakage of parts and any other condition that may affect the power tool's operation. If damaged, have the power tool repaired before use.** Many accidents are caused by poorly maintained power tools.
- f) **Keep cutting tools sharp and clean.** Properly maintained cutting tools with sharp cutting edges are less likely to bind and are easier to control.
- g) **Use the power tool, accessories and tool bits, etc. in accordance with these instructions, taking into account the working conditions and the work to be performed.** Use of the power tool for operations different from those intended could result in a hazardous situation.

### 5) BATTERY TOOL USE AND CARE

- a) **Recharge only with the charger specified by the manufacturer.** A charger that is suitable for one type of

## English

- **Accessories and tools get hot during operation.** Wear gloves when touching them.
- **Do not operate this tool for long periods of time.** Vibration caused by tool action may be harmful to your hands and arms. Use gloves to provide extra cushion and limit exposure by taking frequent rest periods.
- **Air vents often cover moving parts and should be avoided.** Loose clothes, jewelry or long hair can be caught in moving parts.
- **⚠ WARNING: ALWAYS** use safety glasses. Everyday eyeglasses are NOT safety glasses. Also use face or dust mask if cutting operation is dusty. ALWAYS WEAR CERTIFIED SAFETY EQUIPMENT:
  - ANSI Z87.1 eye protection (CAN/CSA Z94.3),
  - ANSI S12.6 (S3.19) hearing protection,
  - NIOSH/OSHA/MSHA respiratory protection.
- **⚠ WARNING:** Some dust created by power sanding, sawing, grinding, drilling, and other construction activities contains chemicals known to the State of California to cause cancer, birth defects or other reproductive harm. Some examples of these chemicals are:
  - lead from lead-based paints,
  - crystalline silica from bricks and cement and other masonry products, and
  - arsenic and chromium from chemically-treated lumber.Your risk from these exposures varies, depending on how often you do this type of work. To reduce your exposure to these chemicals: work in a well ventilated area, and work with approved safety equipment, such as those dust masks that are specially designed to filter out microscopic particles.
- **Avoid prolonged contact with dust from power sanding, sawing, grinding, drilling, and other construction activities. Wear protective clothing and wash exposed areas with soap and water.** Allowing dust to get into your mouth, eyes, or lay on the skin may promote absorption of harmful chemicals.

- battery pack may create a risk of fire when used with another battery pack.
- a) **Use power tools only with specifically designated battery packs.** Use of any other battery packs may create a risk of injury and fire.
  - b) **When battery pack is not in use, keep it away from other metal objects, like paper clips, coins, keys, nails, screws, or other small metal objects, that can make a connection from one terminal to another.** Shorting the battery terminals together may cause burns or a fire.
  - c) **Under abusive conditions, liquid may be ejected from the battery; avoid contact. If contact accidentally occurs, flush with water. If liquid contacts eyes, additionally seek medical help.** Liquid ejected from the battery may cause irritation or burns.

### 6) SERVICE

- a) **Have your power tool serviced by a qualified repair person using only identical replacement parts.** This will ensure that the safety of the power tool is maintained.

### Additional Specific Safety Rules

- **Hold power tool by insulated gripping surfaces, when performing an operation where the fastener may contact hidden wiring.** Fasteners contacting a "live" wire may make exposed metal parts of the power tool "live" and could give the operator an electric shock.
- **Use clamps or other practical way to secure and support the workpiece to a stable platform.** Holding the work by hand or against your body is unstable and may lead to loss of control.
- **Wear safety goggles or other eye protection.** Hammering and drilling operations cause chips to fly. Flying particles can cause permanent eye damage.

**⚠ WARNING:** Use of this tool can generate and/or disperse dust, which may cause serious and permanent respiratory or other injury. Always use NIOSH/OSHA approved respiratory protection appropriate for the dust exposure. Direct particles away from face and body.

**⚠ WARNING:** Always wear proper personal hearing protection that conforms to ANSI S12.6 (S3.19) during use. Under some conditions and duration of use, noise from this product may contribute to hearing loss.

**⚠ CAUTION:** When not in use, place tool on its side on a stable surface where it will not cause a tripping or falling hazard. Some tools with large battery packs will stand upright on the battery pack but may be easily knocked over.

- The label on your tool may include the following symbols. The symbols and their definitions are as follows:

V.....	volts	A.....	amperes
Hz.....	hertz	W.....	watts
min.....	minutes	~ or AC.....	alternating current
⎓ or DC... direct current		⎓ or AC/DC... alternating or direct current	
Ⓛ.....	Class I Construction (grounded)	Ⓜ.....	no load
Ⓜ.....	Class II Construction (double insulated)	n.....	speed
.../min.....	per minute	n.....	rated speed
BPM.....	beats per minute	⊕.....	earthing terminal
IPM.....	impacts per minute	⚠.....	safety alert symbol
RPM.....	revolutions per minute		
sfpm.....	surface feet per minute		

## Important Safety Instructions for All Battery Packs

When ordering replacement battery packs, be sure to include catalog number and voltage. Consult the chart at the end of this manual for compatibility of chargers and battery packs.

The battery pack is not fully charged out of the carton. Before using the battery pack and charger, read the safety instructions below. Then follow charging procedures outlined.

### READ ALL INSTRUCTIONS

- Do not charge or use battery in explosive atmospheres, such as in the presence of flammable liquids, gases or dust.** Inserting or removing the battery from the charger may ignite the dust or fumes.
- NEVER force battery pack into charger. DO NOT modify battery pack in any way to fit into a non-compatible charger as battery pack may rupture causing serious personal injury.** Consult the chart at the end of this manual for compatibility of batteries and chargers.
- Charge the battery packs only in DEWALT chargers.
- DO NOT** splash or immerse in water or other liquids.
- Do not store or use the tool and battery pack in locations where the temperature may reach or exceed 105 °F (40 °C) (such as outside sheds or metal buildings in summer).**

**⚠ DANGER:** Electrocutation hazard. Never attempt to open the battery pack for any reason. If battery pack case is cracked or damaged, do not insert into charger. Do not crush, drop or damage battery pack. Do not use a battery pack or charger that has received a sharp blow, been dropped, run over or damaged in any way (i.e., pierced with a nail, hit with a hammer, stepped on). Electric shock or electrocution may result. Damaged battery packs should be returned to service center for recycling.



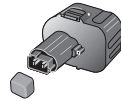

**NOTE:** Battery storage and carrying caps are provided for use whenever the battery is out of the tool or charger. Remove cap before placing battery in charger or tool.

**⚠ WARNING: Fire hazard. Do not store or carry battery so that metal objects can contact exposed battery terminals.** For example, do not place battery in aprons, pockets, tool boxes, product kit boxes, drawers, etc., with loose nails, screws, keys, etc. without battery cap. **Transporting batteries can possibly cause fires if the battery terminals inadvertently come in contact with conductive materials such as keys, coins, hand tools and the like.** The U.S. Department of Transportation Hazardous Material Regulations (HMR) actually prohibit transporting batteries in commerce or on airplanes (i.e., packed in suitcases and carry-on luggage) UNLESS they are properly protected from short circuits. So when transporting individual batteries, make sure that the battery terminals are protected and well insulated from materials that could contact them and cause a short circuit.

#### **SPECIFIC SAFETY INSTRUCTIONS FOR NICKEL CADMIUM (NiCd) OR NICKEL METAL HYDRIDE (NiMH)**

- **Do not incinerate the battery pack even if it is severely damaged or is completely worn out.** The battery pack can explode in a fire.
- **A small leakage of liquid from the battery pack cells may occur under extreme usage or temperature conditions.** This does not indicate a failure.

However, if the outer seal is broken:

- a. and the battery liquid gets on your skin, immediately wash with soap and water for several minutes.
- b. and the battery liquid gets into your eyes, flush them with clean water for a minimum of 10 minutes and seek immediate

medical attention. **(Medical note: The liquid is 25–35% solution of potassium hydroxide.)**

#### **SPECIFIC SAFETY INSTRUCTIONS FOR LITHIUM ION (Li-Ion)**

- **Do not incinerate the battery pack even if it is severely damaged or is completely worn out.** The battery pack can explode in a fire. Toxic fumes and materials are created when lithium ion battery packs are burned.
- **If battery contents come into contact with the skin, immediately wash area with mild soap and water.** If battery liquid gets into the eye, rinse water over the open eye for 15 minutes or until irritation ceases. If medical attention is needed, the battery electrolyte is composed of a mixture of liquid organic carbonates and lithium salts.
- **Contents of opened battery cells may cause respiratory irritation.** Provide fresh air. If symptoms persist, seek medical attention.

**⚠ WARNING: Burn hazard. Battery liquid may be flammable if exposed to spark or flame.**

#### **The RBRC™ Seal**

The RBRC™ (Rechargeable Battery Recycling Corporation) Seal on the nickel cadmium, nickel metal hydride or lithium ion batteries (or battery packs) indicate that the costs to recycle these batteries (or battery packs) at the end of their useful life have already been paid by DEWALT. In some areas, it is illegal to place spent nickel cadmium, nickel metal hydride or lithium ion batteries in the trash or municipal solid waste stream and the RBRC program provides an environmentally conscious alternative.



RBRC™ in cooperation with DEWALT and other battery users, has established programs in the United States and Canada to facilitate the collection of spent nickel cadmium, nickel metal hydride or lithium

ion batteries. Help protect our environment and conserve natural resources by returning the spent nickel cadmium, nickel metal hydride or lithium ion batteries to an authorized DEWALT service center or to your local retailer for recycling. You may also contact your local recycling center for information on where to drop off the spent battery.

RBRC™ is a registered trademark of the Rechargeable Battery Recycling Corporation.

### **Important Safety Instructions for All Battery Chargers**

**SAVE THESE INSTRUCTIONS:** This manual contains important safety and operating instructions for battery chargers.

- Before using charger, read all instructions and cautionary markings on charger, battery pack, and product using battery pack.
- ⚠ **DANGER:** Electrocutation hazard. 120 volts are present at charging terminals. Do not probe with conductive objects. Electric shock or electrocution may result.
- ⚠ **WARNING:** Shock hazard. Do not allow any liquid to get inside charger. Electric shock may result.
- ⚠ **CAUTION:** Burn hazard. To reduce the risk of injury, charge only DEWALT rechargeable batteries. Other types of batteries may burst causing personal injury and damage.
- NOTICE:** Under certain conditions, with the charger plugged in to the power supply, the exposed charging contacts inside the charger can be shorted by foreign material. Foreign materials of a conductive nature such as, but not limited to, grinding dust, metal chips, steel wool, aluminum foil, or any buildup of metallic particles should be kept away from charger cavities. Always unplug the charger from the power supply when there is no battery pack in the cavity. Unplug charger before attempting to clean.

- **DO NOT attempt to charge the battery pack with any chargers other than the ones in this manual.** The charger and battery pack are specifically designed to work together.
- **These chargers are not intended for any uses other than charging DEWALT rechargeable batteries.** Any other uses may result in risk of fire, electric shock or electrocution.
- **Do not expose charger to rain or snow.**
- **Pull by plug rather than cord when disconnecting charger.** This will reduce risk of damage to electric plug and cord.
- **Make sure that cord is located so that it will not be stepped on, tripped over, or otherwise subjected to damage or stress.**
- **Do not use an extension cord unless it is absolutely necessary.** Use of improper extension cord could result in risk of fire, electric shock, or electrocution.
- **When operating a power tool outdoors, use an extension cord suitable for outdoor use.** Use of a cord suitable for outdoor use reduces the risk of electric shock.
- **An extension cord must have adequate wire size (AWG or American Wire Gauge) for safety.** The smaller the gauge number of the wire, the greater the capacity of the cable, that is 16 gauge has more capacity than 18 gauge. An undersized cord will cause a drop in line voltage resulting in loss of power and overheating. When using more than one extension to make up the total length, be sure each individual extension contains at least the minimum wire size. The following table shows the correct size to use depending on cord length and nameplate ampere rating. If in doubt, use the next heavier gauge. The smaller the gauge number, the heavier the cord.

### Using Automatic Tune-Up™ Mode

The automatic Tune-Up™ Mode equalizes or balances the individual cells in the battery pack allowing it to function at peak capacity. Battery packs should be tuned up weekly or after 10 charge/discharge cycles or whenever the pack no longer delivers the same amount of work. To use the automatic Tune-Up™, place the battery pack in the charger and leave it for at least 8 hours. The charger will cycle through the following modes.

1. The red light will blink continuously indicating that the 1-hour charge cycle has started.
2. When the 1-hour charge cycle is complete, the light will stay on continuously and will no longer blink. This indicates that the pack is fully charged and can be used at this time.
3. If the pack is left in the charger after the initial 1-hour charge, the charger will begin the Automatic Tune-Up™ mode. This mode continues up to 8 hours or until the individual cells in the battery pack are equalized. The battery pack is ready for use and can be removed at any time during the Automatic Tune-Up™ mode.
4. Once the Automatic Tune-Up™ mode is complete, the charger will begin a maintenance charge; the red indicator will remain lit.

### Chargers

Your tool uses a DEWALT charger. Be sure to read all safety instructions before using your charger. Consult the chart at the end of this manual for compatibility of chargers and battery packs.

### Charging Procedure (Fig. 1)

**⚠ DANGER:** Electrocutation hazard. 120 volts are present at charging terminals. Do not probe with conductive objects. Electric shock or electrocution may result.

1. Plug the charger into an appropriate outlet before inserting battery pack.

		Minimum Gauge for Cord Sets			
		Volts	Total Length of Cord in Feet (meters)		
Ampere Rating	120V	25 (7.6)	50 (15.2)	100 (30.5)	150 (45.7)
	240V	50 (15.2)	100 (30.5)	200 (61.0)	300 (91.4)
More Than	Not More Than	AWG			
0	6	18	16	16	14
6	10	18	16	14	12
10	12	16	16	14	12
12	16	14	12	Not Recommended	

- **Do not place any object on top of charger or place the charger on a soft surface that might block the ventilation slots and result in excessive internal heat.** Place the charger in a position away from any heat source. The charger is ventilated through slots in the top and the bottom of the housing.
- **Do not operate charger with damaged cord or plug.**
- **Do not operate charger if it has received a sharp blow, been dropped, or otherwise damaged in any way.** Take it to an authorized service center.
- **Do not disassemble charger; take it to an authorized service center when service or repair is required.** Incorrect reassembly may result in a risk of electric shock, electrocution or fire.
- **Disconnect the charger from the outlet before attempting any cleaning. This will reduce the risk of electric shock.** Removing the battery pack will not reduce this risk.
- **NEVER** attempt to connect two chargers together.
- **The charger is designed to operate on standard 120 volt household electrical power. Do not attempt to use it on any other voltage.** This does not apply to the vehicular charger.





4. The battery pack should be recharged when it fails to produce sufficient power on jobs which were easily done previously. DO NOT CONTINUE to use under these conditions. Follow the charging procedure. You may also charge a partially used pack whenever you desire with no adverse affect on the battery pack.
5. Under certain conditions, with the charger plugged into the power supply, the exposed charging contacts inside the charger can be shorted by foreign material. Foreign materials of a conductive nature such as, but not limited to, grinding dust, metal chips, steel wool, aluminum foil, or any buildup of metallic particles should be kept away from charger cavities. Always unplug the charger from the power supply when there is no battery pack in the cavity. Unplug charger before attempting to clean.

6. Do not freeze or immerse charger in water or any other liquid.  
**⚠ WARNING: Shock hazard. Don't allow any liquid to get inside charger. Electric shock may result.**

**⚠ WARNING: Burn hazard. Never attempt to open the battery pack for any reason. If the plastic housing of the battery pack breaks or cracks, return to a service center for recycling.**

### **Storage Recommendations**

1. The best storage place is one that is cool and dry away from direct sunlight and excess heat or cold.
2. For long storage, it is recommended to store a fully charged battery pack in a cool dry place out of the charger for optimal results.

**NOTE:** Battery packs should not be stored completely depleted of charge. The battery pack will need to be recharged before use.

**SAVE THESE INSTRUCTIONS  
FOR FUTURE USE**

charge, it may need to be recharged before use. A battery pack may also slowly lose its charge if left in a charger that is not plugged into an appropriate AC source.

**WEAK BATTERY PACKS:** Chargers can also detect a weak battery pack. Such batteries are still usable but should not be expected to perform as much work. The charger will indicate to replace battery pack.

### **Important Charging Notes**

1. Longest life and best performance can be obtained if the battery pack is charged when the air temperature is between 65 °F and 75 °F (18 °-24 °C). DO NOT charge the battery pack in an air temperature below +40 °F (+4.5 °C), or above +105 °F (+40.5 °C). This is important and will prevent serious damage to the battery pack.

2. The charger and battery pack may become warm to touch while charging. This is a normal condition, and does not indicate a problem. To facilitate the cooling of the battery pack after use, avoid placing the charger or battery pack in a warm environment such as in a metal shed, or an uninsulated trailer.

3. If the battery pack does not charge properly:
  - a. Check operation of receptacle by plugging in a lamp or other appliance;
  - b. Check to see if receptacle is connected to a light switch which turns power off when you turn out the lights;
  - c. Move charger and battery pack to a location where the surrounding air temperature is approximately 65 °F-75 °F (18 °- 24 °C);
  - d. If charging problems persist, take the tool, battery pack and charger to your local service center.

FIG. 2

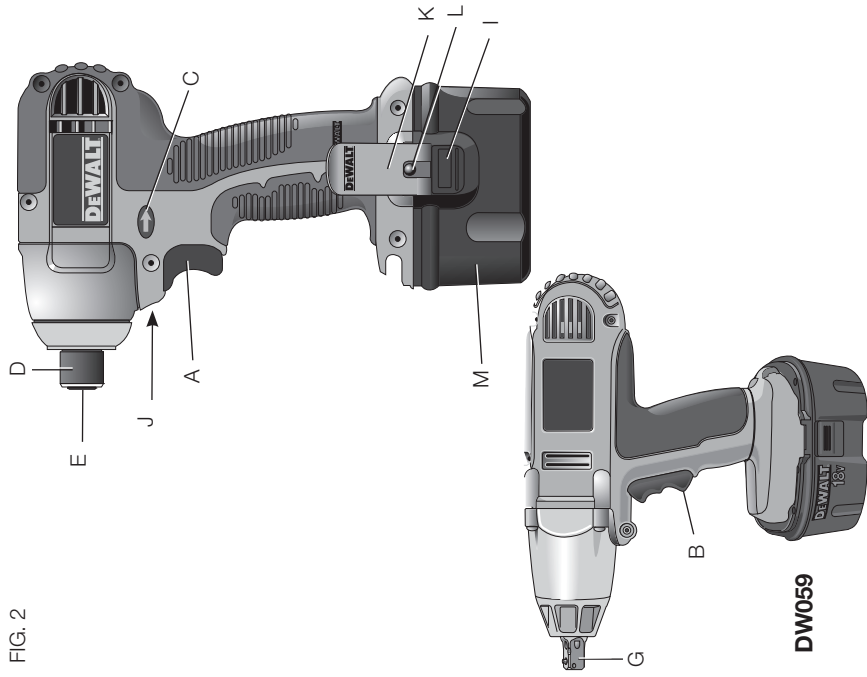

**COMPONENTS (Fig. 2, 5, 6)**

**⚠ WARNING:** Never modify the power tool or any part of it. Damage or personal injury could result.

- A. Trigger switch
- B. Rocker switch (DW059)
- C. Forward/reverse button
- D. Chuck collar
- E. 1/4" hex quick-release chuck
- F. Defent pin
- G. Anvil
- H. Hog ring
- I. Battery release buttons
- J. Worklight
- K. Belt hook (optional)
- L. Belt hook accessory
- M. Battery

**INTENDED USE**

These heavy-duty impact wrench/drivers are designed for professional impact screwdriving applications. The impact function makes this tool particularly useful for driving fasteners in wood, metal and concrete. **DO NOT** use under wet conditions or in presence of flammable liquids or gases.

These heavy-duty impact wrench/drivers are professional power tools. **DO NOT** let children come into contact with the tool. Supervision is required when inexperienced operators use this tool.

**BELT HOOK (OPTIONAL ACCESSORY)**

**⚠ WARNING:** To reduce the risk of serious personal injury, **DO NOT** suspend tool overhead or suspend objects from the belt hook. **ONLY** hang tool's belt hook from a work belt.

**⚠ WARNING:** To reduce the risk of serious personal injury, ensure the screw (L) holding the belt hook is secure.

The belt hook (K) can be attached to either side of the tool to accommodate left- or right- handed users. If the hook is not desired at all, it can be removed from the tool.

### Variable Speed Trigger Switch (Fig. 2)

To turn the tool on, squeeze the trigger switch (A). To turn the tool off, release the trigger switch. Your tool is equipped with a brake. The chuck will stop as soon as the trigger switch is fully released. The variable speed switch enables you to select the best speed for a particular application. The more you squeeze the trigger, the faster the tool will operate. Use lower speeds for starting holes without a center punch, drilling in metals or plastics, or driving screws. For maximum tool life, use variable speed only for starting holes or fasteners.

**NOTE:** Continuous use in variable speed range is not recommended. It may damage the switch and should be avoided.

### Forward/Reverse Control Button (Fig. 2)

A forward/reverse control button (C) determines the direction of the tool and also serves as a lock off button. **To select forward rotation,** release the trigger switch and depress the forward/reverse control button on the right side of the tool. **To select reverse,** depress the forward/reverse control button on the left side of the tool. The center position of the control button locks the tool in the OFF position. When changing the position of the control button, be sure the trigger is released.

**NOTE:** The first time the tool is run after changing the direction of rotation, you may hear a click on start up. This is normal and does not indicate a problem.

### Worklight (Fig. 2)

There is a worklight (J) located just above the trigger switch (A). The worklight will be activated when the trigger switch is squeezed.

**NOTE:** The worklight is for lighting the immediate work surface and is not intended to be used as a flashlight.

To move belt hook, remove the screw (L) that holds the belt hook in place then reassemble on the opposite side.

### OPERATION

**⚠ WARNING:** To reduce the risk of injury, turn unit off and disconnect it from power source before installing and removing accessories, before adjusting or when making repairs. An accidental start-up can cause injury.

### Installing and Removing the Battery Pack (Fig. 3)

**NOTE:** For best results, make sure your battery pack is fully charged.

To install the battery pack into the tool handle, align the notch inside the tool's handle with the battery pack and slide the battery pack firmly into the handle until you hear the lock snap into place as shown in Figure 2.

To remove the battery pack from the tool, press the release buttons (I) and firmly pull the battery pack out of the tool handle. Insert it into the charger as described in the charger section of this manual.

### Switch – DW059, DW059H (Fig. 2)

Pressing the BOTTOM part of the rocker switch (B) runs the tool in forward (right hand thread) direction. Pressing the TOP of the switch reverses motor direction. This allows “rocking” fasteners to break them loose.

FIG. 3

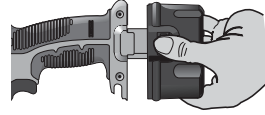
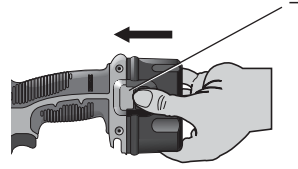

### Quick-Release Chuck (Fig. 4)

DC825, DC827, DC835, DC845, DC855, DCF826

**NOTE:** The chuck accepts 1/4" (6.35 mm) hex accessories only.

Place the switch in the locked off (center) position or remove battery pack before changing accessories.

**To install an accessory,** pull the chuck collar (D) away from the front of the tool, insert the accessory and release the collar. The accessory is locked in place.

**To remove an accessory,** pull the chuck collar away from the front of the tool. Remove the accessory and release the collar.

FIG. 4

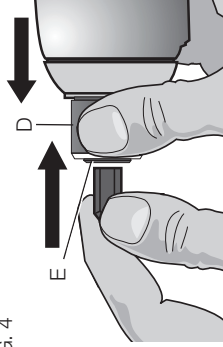

### ANVIL WITH DETENT PIN (FIG. 5)

DC820, DC821, DC822, DC830, DC840, DW059

**To install an accessory on the anvil,** align the hole in the side of the accessory with the detent pin (F) on the anvil (G). Press the accessory on until the detent pin engages in the hole. Depression of detent pin may be necessary to aid installation of accessory.

**To remove an accessory,** depress the detent pin through the hole and pull the accessory off.

FIG. 5

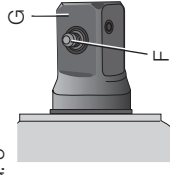

DC820, DC822,  
DC830, DC840,  
DW059

### ANVIL WITH HOG RING (FIG. 6)

DC823, DC833, DC841, DW059H

**To install an accessory on the hog ring anvil,** firmly push accessory onto the anvil (G). The hog ring (H) compresses to allow the accessory to slide on. After the accessory is installed, the hog ring applies pressure to help provide accessory retention.

**To remove an accessory,** grasp the accessory and firmly pull it off.

FIG. 6

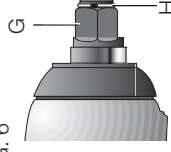

DC823,  
DC833, DC841,  
DW059H

### Anvils

**⚠ WARNING:** Use only impact accessories. Non-impact accessories may break and cause a hazardous condition. Inspect accessory prior to use to ensure that it contains no cracks.

**⚠ CAUTION:** Inspect anvils, detent pins, and hog rings prior to use. Missing or damaged items should be replaced before use.

Place the switch in the locked off (center) position or remove battery pack before changing accessories.



## English

### Usage

Your impact tool generates the following output torque:

Cat #	Ft.-Lbs.	In.-Lbs.	Nm
DC820	145	1740	195
DC821	160	1920	215
DC822	145	1740	195
DC823	120	1440	160
DC825	111	1330	150
DC827	111	1330	150
DCF826	111	1330	150
DC830	135	1620	180
DC833	111	1330	150
DC835	103	1240	140
DC840	120	1440	160
DC841	105	1260	145
DC845	96	1150	130
DC855	80	960	110
DW059	300	3600	405
DW059H	300	3600	405

**⚠CAUTION:** Ensure fastener and/or system will withstand the level of torque generated by the tool. Excessive torque may cause breakage and possible personal injury.

1. Place the accessory on the fastener head. Keep the tool pointed straight at the fastener.
2. Press switch to start operation. Always check torque with a torque wrench, as the fastening torque is affected by many factors including the following:

- **Voltage:** Low voltage, due to a nearly discharged battery, will reduce fastening torque.

- **Accessory size:** Failure to use the correct accessory size will cause a reduction in fastening torque.
- **Bolt Size:** Larger bolt diameters generally require higher fastening torque. Fastening torque will also vary according to length, grade, and torque coefficient.
- **Bolt:** Ensure that all threads are free of rust and other debris to allow proper fastening torque.
- **Material:** The type of material and surface finish of the material will affect fastening torque.
- **Fastening Time:** Longer fastening time results in increased fastening torque. Using a longer fastening time than recommended could cause the fasteners to be overstressed, stripped or damaged.

### MAINTENANCE

**⚠WARNING:** To reduce the risk of injury, turn unit off and disconnect it from power source before installing and removing accessories, before adjusting or when making repairs. An accidental start-up can cause injury.

### Cleaning

**⚠WARNING:** Blow dirt and dust out of all air vents with clean, dry air at least once a week. To minimize the risk of eye injury, always wear ANSI Z87.1 approved eye protection when performing this.

**⚠WARNING:** Never use solvents or other harsh chemicals for cleaning the non-metallic parts of the tool. These chemicals may weaken the plastic materials used in these parts. Use a cloth dampened only with water and mild soap. Never let any liquid get inside the tool; never immerse any part of the tool into a liquid.

### CHARGER CLEANING INSTRUCTIONS

**⚠WARNING:** Shock hazard. Disconnect the charger from the AC outlet before cleaning. Dirt and grease may be removed from the

exterior of the charger using a cloth or soft non-metallic brush. Do not use water or any cleaning solutions.

**Accessories**

**⚠WARNING:** Since accessories, other than those offered by DEWALT, have not been tested with this product, use of such accessories with this tool could be hazardous. To reduce the risk of injury, only DEWALT recommended accessories should be used with this product.

**⚠WARNING:** Use only impact accessories. Non-impact accessories may break and cause a hazardous condition. Inspect accessory prior to use to ensure that it contains no cracks.

Recommended accessories for use with your tool are available at extra cost from your local dealer or authorized service center. If you need assistance in locating any accessory, please contact DEWALT Industrial Tool Co., 701 East Joppa Road, Baltimore, MD 21286, call 1-800-4-DEWALT (1-800-433-9258) or visit our website: www.dewalt.com.

**Repairs**

The charger and battery pack are not serviceable.

To assure product SAFETY and RELIABILITY, repairs, maintenance and adjustment (including brush inspection and replacement) should be performed by a DEWALT factory service center, a DEWALT authorized service center or other qualified service personnel. Always use identical replacement parts.

**Register Online**

Thank you for your purchase. Register your product now for:

- **WARRANTY SERVICE:** Registering your product will help you obtain more efficient warranty service in case there is a problem with your product.

- **CONFIRMATION OF OWNERSHIP:** In case of an insurance loss, such as fire, flood or theft, your registration of ownership will serve as your proof of purchase.

- **FOR YOUR SAFETY:** Registering your product will allow us to contact you in the unlikely event a safety notification is required under the Federal Consumer Safety Act.

**Three Year Limited Warranty**

DEWALT will repair, without charge, any defects due to faulty materials or workmanship for three years from the date of purchase. This warranty does not cover part failure due to normal wear or tool abuse. For further detail of warranty coverage and warranty repair information, visit www.dewalt.com or call 1-800-4-DEWALT (1-800-433-9258). This warranty does not apply to accessories or damage caused where repairs have been made or attempted by others. This warranty gives you specific legal rights and you may have other rights which vary in certain states or provinces.

In addition to the warranty, DEWALT tools are covered by our:

**1 YEAR FREE SERVICE**

DEWALT will maintain the tool and replace worn parts caused by normal use, for free, any time during the first year after purchase.

**2 YEARS FREE SERVICE ON DEWALT BATTERY PACKS**

DC9071, DC9091, DC9096, DC9280, DC9360, DC9180, DCB120 and DCB201

**3 YEARS FREE SERVICE ON DEWALT BATTERY PACKS**

DCB200

**DEWALT BATTERY PACKS**

Product warranty voided if the battery pack is tampered with in any way. DEWALT is not responsible for any injury caused by tampering and may prosecute warranty fraud to the fullest extent permitted by law.

**90 DAY MONEY BACK GUARANTEE**

If you are not completely satisfied with the performance of your DEWALT Power Tool, Laser, or Nailer for any reason, you can return it within 90 days from the date of purchase with a receipt for a full refund – no questions asked.

**LATIN AMERICA:** This warranty does not apply to products sold in Latin America. For products sold in Latin America, see country specific warranty information contained in the packaging, call the local company or see website for warranty information.

**FREE WARNING LABEL REPLACEMENT:** If your warning labels become illegible or are missing, call 1-800-4-DEWALT (1-800-433-9258) for a free replacement.

<b>DCXXX</b>
SER. _____
 <b>WARNING</b> TO REDUCE THE RISK OF INJURY USER MUST READ INSTRUCTION MANUAL. USE ONLY WITH DEWALT BATTERIES. ALWAYS USE PROPER EYE AND RESPIRATORY PROTECTION. <small>DEWALT INDUSTRIAL TOOL CO. BALTIMORE, MD 21286 U.S.A. FOR SERVICE INFORMATION, CALL 1-800-4-DEWALT www.dewalt.com</small>

 <b>ADVERTENCIA</b> PARA EL MANEJO SEGURO LEA EL MANUAL DE INSTRUCCIONES.
 <b>AVERTISSEMENT</b> À TITRE PREVENTIF, LIRE LE GUIDE.