

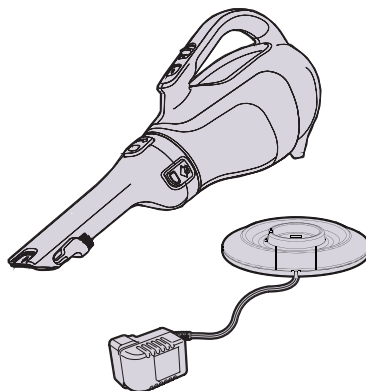

## CORDLESS HAND VAC

# INSTRUCTION MANUAL

Catalog Number CHV1410L Series



Thank you for choosing Black & Decker! Go to [www.BlackandDecker.com/NewOwner](http://www.BlackandDecker.com/NewOwner) to register your new product.

### PLEASE READ BEFORE RETURNING THIS PRODUCT FOR ANY REASON:

If you have a question or experience a problem with your Black & Decker purchase, go to

[WWW.BLACKANDDECKER.COM/INSTANTANSWERS](http://WWW.BLACKANDDECKER.COM/INSTANTANSWERS) for instant answers 24 hours a day.

If you can't find the answer or do not have access to the internet, call 1-800-544-6986 from 8 a.m. to 5 p.m. EST Mon. - Fri to speak with an agent.

Please have the catalog number available when you call.

To purchase a replacement filter call 1-888-678-7278.

**SAVE THIS MANUAL FOR FUTURE REFERENCE.  
FOR HOUSEHOLD USE ONLY.**

VEA EL ESPAÑOL EN LA CONTRAPORTADA.

POUR LE FRANÇAIS, VOIR LA COUVERTURE ARRIÈRE.

INSTRUCTIVO DE OPERACIÓN, CENTROS DE SERVICIO Y PÓLIZA DE GARANTÍA.

ADVERTENCIA: LÉASE ESTE INSTRUCTIVO ANTES DE USAR EL PRODUCTO.

# IMPORTANT SAFEGUARDS

When using electrical appliances, basic safety precautions should always be followed, including the following:

**PLEASE READ AND UNDERSTAND ALL INSTRUCTIONS BEFORE USING THE UNIT.**

## SAFETY GUIDELINES - DEFINITIONS

It is important for you to read and understand this manual.

The information it contains relates to protecting YOUR SAFETY and PREVENTING PROBLEMS. The symbols below are used to help you recognize this information.

**⚠ DANGER:** Indicates an imminently hazardous situation which, if not avoided, will result in death or serious injury.

**⚠ WARNING:** Indicates a potentially hazardous situation which, if not avoided, could result in death or serious injury.

**⚠ CAUTION:** Indicates a potentially hazardous situation which, if not avoided, may result in minor or moderate injury.

**NOTICE:** Used without the safety alert symbol indicates potentially hazardous situation which, if not avoided, may result in property damage.

**⚠ WARNING:** Some household dust contains chemicals known to the State of California to cause cancer, birth defects or other reproductive harm such as asbestos and lead in lead based paint.

- ⚠ WARNING:** To reduce the risk of fire, electrical shock or injury:
- Close supervision is necessary when any appliance is used by or near children. Do not allow to be used as a toy.
  - **Shock Hazard.** To protect against risk of electrical shock, do not put unit or charging base in water or other liquid.
  - Do not use dry hand vacs to pick up liquids, toxic substances, flammable or combustible liquids such as gasoline or use in areas where they may be present.
  - Do not use wet/dry hand vacs to pick up toxic substances, flammable or combustible liquids such as gasoline or use in areas where they may be present.
  - Do not operate in the presence of explosives and/or flammable fumes or liquids.
  - **Shock Hazard.** Do not operate any appliance with a damaged cord or charger or after the appliance malfunctions, is left outdoors, dropped into water or is damaged in any manner. Return the appliance to any authorized service facility.
  - Do not use dry hand vacs outdoors or on wet surfaces.
  - Do not abuse the cord. Never carry the charger or base by the cord or yank to disconnect from an outlet; instead grasp the charger and pull to disconnect. Keep cord away from heated surfaces. Do not pull cord around sharp edges or corners.
  - Do not allow the cord to hang over the edge of a table or counter or touch hot surfaces. The unit should be placed or mounted away from sinks and hot surfaces.
  - Do not use an extension cord. Plug the charger directly into an electrical outlet.
  - Use the charger only in a standard electrical outlet (120V/60Hz).
  - Do not attempt to use the charger with any other product; do not attempt to charge this product with any other charger. Use only the charger supplied by the manufacturer to recharge.
  - Keep hair, loose clothing, and all parts of body away from openings and moving parts.
  - Do not insert accessories when unit is running.

- **Shock Hazard.** Do not handle plug or appliance with wet hands.
- Do not put any object into unit openings. Do not use with any openings blocked; keep free of dust, lint, hair, and anything that may reduce air flow.
- **Fire Hazard.** Do not vacuum burning or smoking materials, such as lit cigarette butts, matches or hot ashes.
- Do not use on or near hot surfaces.
- Use extra caution when cleaning on stairs.
- This appliance is intended for household use only and not for commercial or industrial use.
- Use only as described in this manual. Use only manufacturer's recommended attachments.
- Unplug the charger from outlet before any routine cleaning or maintenance.
- This product includes rechargeable Lithium Ion batteries. Do not incinerate batteries as they will explode at high temperatures.
- **If battery contents come into contact with the skin, immediately wash area with mild soap and water.** If battery liquid gets into the eye, rinse water over the open eye for 15 minutes or until irritation ceases. If medical attention is needed, the battery electrolyte for Lithium Ion batteries is composed of a mixture of liquid organic carbonates and lithium salts.







**⚠ WARNING:** Do not look into the air vents when the unit is switched on, as sometimes there is a possibility of small debris being discharged from the air vents, especially after cleaning / replacement of the filters as debris inside the unit can be disturbed.

- The charger supplied with this product is intended to be plugged in such that it is correctly orientated in a vertical or floor mount position.

## SAVE THESE INSTRUCTIONS

### Symbols

- The label on your tool may include the following symbols. The symbols and their definitions are as follows:
 

<p><i>V</i>.....volts</p> <p><i>Hz</i>.....hertz</p> <p><i>min</i> .....minutes</p> <p> .....direct current</p> <p> .....Class I Construction (grounded)</p> <p> .....Class II Construction (double insulated)</p>	<p><i>A</i> .....amperes</p> <p><i>W</i>.....watts</p> <p> .....alternating current</p> <p><i>n<sub>0</sub></i> .....no load speed</p> <p> .....earthing terminal</p> <p> .....safety alert symbol</p> <p><i>.../min or rpm..</i>revolutions or reciprocation per minute</p>
---	---

## Product Features

1. On/off switch
2. Bowl release button
3. Charging indicator
4. Dust bowl
5. Nozzle
6. Nozzle release button
7. Nozzle rotating button
8. Extendable crevice tool
9. Flip-up Brush
10. Charger base
11. Charger
12. Cloth filter
13. Plastic pre-filter

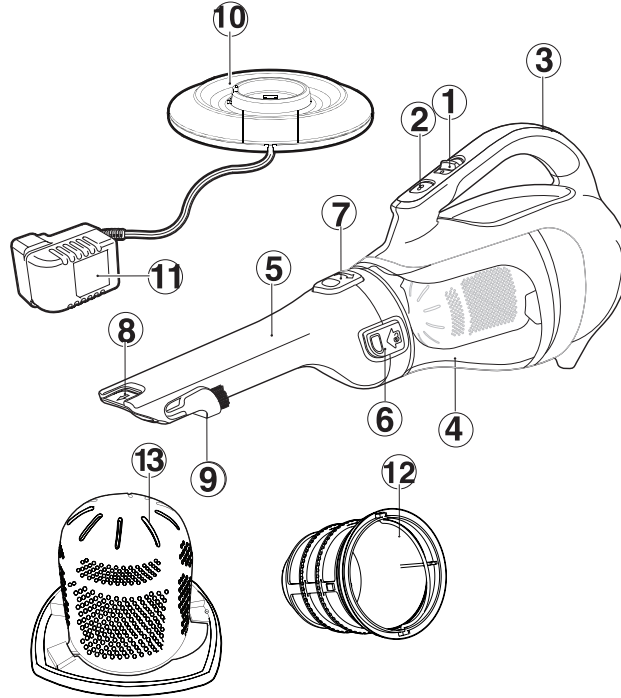

### Charging the battery

- Place the appliance on the charging base as shown.
- Plug in the charger. The charging indicator will flash continuously (slowly).
- Leave the appliance to charge.

While charging, the charger may get warm, this is perfectly normal and safe. The charging indicator will be lit as long as the appliance is connected to the plugged-in charger. It can remain on charge indefinitely without damage or danger. It is not possible to “overcharge” the battery cells with the charger provided.

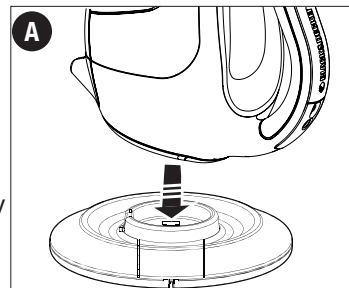

**⚠ WARNING:** Do not charge the battery at ambient temperatures below 39°F (4°C) or above 104°F (40°C).

The charge is complete when the charging indicator lights continuously. The charger and the battery can be left connected indefinitely with the LED illuminated. The LED will change to flashing (charging) state as the charger occasionally tops off the battery charge.

- Charge discharged batteries within 1 week. Battery life will be greatly diminished if stored in a discharged state.

### Battery diagnostics

If the appliance detects a weak battery, the charging indicator will flash at a fast rate. Proceed as follows:

- Place the appliance on the charging base.
- Plug in the charger.
- Leave the appliance to charge.

If the appliance detects a damaged battery, the charging indicator will flash at a fast rate when the appliance is on the charger base. Proceed as follows:

- Take the appliance and the charger to be tested at an authorized service facility.

**Note: It may take as long as 60 minutes to determine that the battery is defective. If the battery is too hot or too cold, the LED will alternately blink, fast and slow, one flash at each speed and repeat.**

## Use

### Switching on and off

- **Figure B** - To start, slide the On/Off switch forward (i.e. "O" = Off, "I" = On).
- To stop, slide the switch back.
- Return the product to the charger immediately after use so that it will be ready and fully charged for the next use. Ensure that the product is fully engaged with the charger base.

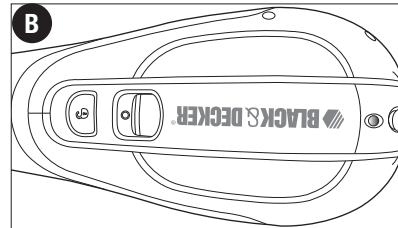

### Cleaning and emptying the product

**⚠ WARNING:** Projectile/Respiratory Hazard: Never use the vac without its filter.

**NOTE:** The filter is re-usable, do not confuse it with a disposable dust bag, and do not throw it away when the product is emptied. We recommend that you replace the filter every 6-9 months depending on frequency of use.

There are two methods of cleaning the bowl, a quick empty method and a thorough clean method.

#### For a quick empty (figures C,D)

- **Figure C** - Press in on both nozzle release buttons on the sides of the nozzle and remove the nozzle by pulling straight off.

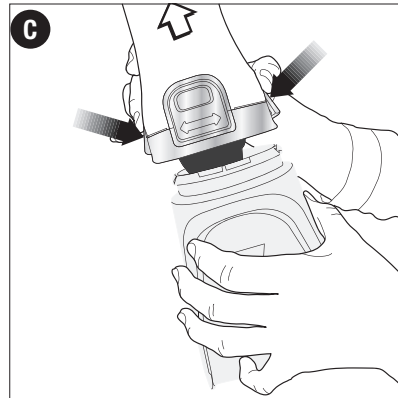

- **Figure D** - Empty the dust from the bowl.
- For a more thorough cleaning, remove bowl as described in **figures E, F, & G.**

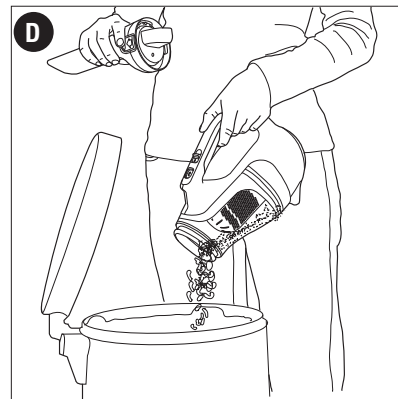

### Removing the dust bowl and filters (figures E, F, & G)

**⚠ WARNING:** The filters are re-usable and should be cleaned regularly.

- Press the release latch and pull the dust bowl straight off.
- While holding the dust bowl over a bin or sink, pull out the filter to empty the contents of the bowl.
- To replace the dust bowl, place it back onto the handle until it “clicks” firmly into position.

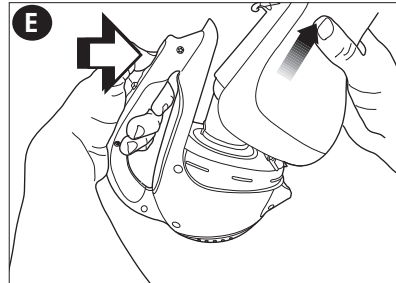

**⚠ WARNING:** Never use the appliance without the filters. Optimum dust collection will only be achieved with clean filters.

### Pre-filter (figure F)

The Pre filter and Pre Filter Housing can be separated to allow better cleaning.

- Twist the Pre Filter (F1) in a clockwise direction and lift from the Pre Filter Housing (F2)

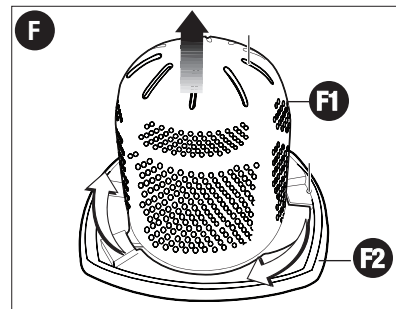

### Quick clean filter (figure G)

- Lift the filter cleaning handle.
- While holding the quick clean filter housing (G1), turn the filter cleaning handle (G2) to perform a quick clean of the filter.
- Pull the filter out of the quick clean filter housing for more thorough cleaning.

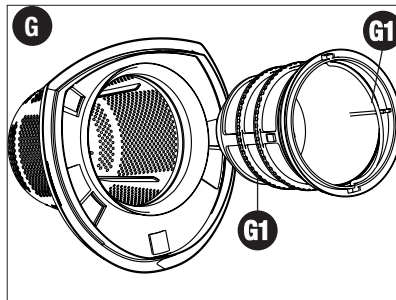

### Cleaning the dust bowls and filters

- The dust bowls and filters can be washed in warm soapy water.
- Make sure that the filters and the dust bowl are dry before re-fitting.

## Nozzle / Accessories

- **Figure H** - A crevice tool is built into the nozzle and can be extended as shown in figure H by pulling the extension piece until it locks into position.

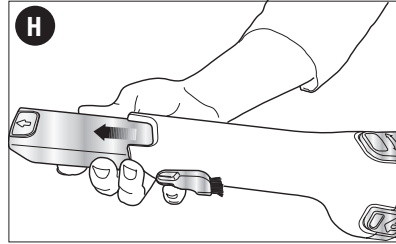

- **Figure I** - A brush accessory is built into the nozzle and can be flipped upwards for use.

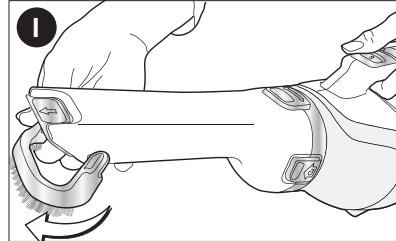

- **Figure J** - The nozzle can be rotated for better access in tight spots. To rotate the nozzle, press the button shown in figure J and rotate the nozzle to the left or right until it clicks into place.

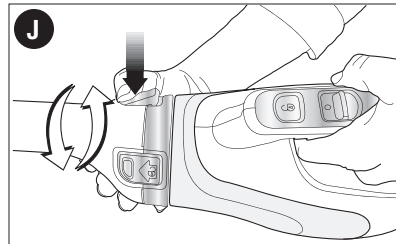

## Replacing the filters

The filters should be replaced every 6 to 9 months and whenever worn or damaged. Replacement filters are available from your Black & Decker dealer.

Visit [www.blackanddecker.com](http://www.blackanddecker.com) to locate dealers.

- Remove the old filters as described above.
- Fit the new filters as described above.

## Maintenance

Bowls and filters can be washed thoroughly; however, use only mild soap and a damp cloth to clean the main part of the vacuum.

**IMPORTANT:** To assure product SAFETY and RELIABILITY, repairs, maintenance and adjustment (other than those listed in this manual) should be performed by authorized service centers or other qualified service personnel, always using identical replacement parts.

## Troubleshooting

If the product does not work, check the following:

- The charge indicator light is flashing when unit is connected to charger.
- The charger was correctly plugged in for recharge. (It feels slightly warm to the touch.)
- The charger cord is not damaged and is correctly attached.
- The charger is plugged into a working electrical outlet.
- The switch is in the "OFF" position when charging.

For assistance with your product, visit our website [www.blackanddecker.com](http://www.blackanddecker.com) for the location of the service center nearest you or call the BLACK & DECKER help line at 1-800-544-6986.

## Accessories

Recommended accessories for use with your product are available from your local dealer or authorized service center. If you need assistance regarding accessories, please call: **1-800-544-6986**.

**⚠ WARNING:** The use of any accessory not recommended for use with this product could be hazardous.

## Battery Removal and Disposal

This product uses Lithium Ion rechargeable and recyclable batteries. When the batteries no longer hold a charge, they should be removed from the Vac and recycled. They must not be incinerated or composted.

The batteries can be taken for disposal to a Black & Decker, Company-Owned or Authorized Service Center. Some local retailers are also participating in a national recycling program (see "RBRC™ Seal"). Call your local retailer for details. If you bring the batteries to a Black & Decker Company-Owned or Authorized Service Center, the Center will arrange to recycle old batteries. Or, contact your local municipality for proper disposal instructions in your city/town.

To remove the battery pack for disposal:

- 1.) First, before attempting to disassemble the product, turn it on and leave it on until the motor completely stops insuring a complete discharge of the batteries.
- 2.) Using a phillips screwdriver, remove the seven screws securing the two housing halves.
- 3.) Lift the housing cover away from the assembly.
- 4.) Detach all lead connections from battery pack.
- 5.) Remove battery pack and dispose of as per recommended guidelines.

## The RBRC™ Seal

The RBRC™ (Rechargeable Battery Recycling Corporation)

Seal on the Lithium Ion battery (or battery pack) indicates that the costs to recycle the battery (or battery pack) at the end of its useful life have already been paid by Black & Decker. In some areas, it is illegal to place spent Lithium Ion batteries in the trash or municipal solid waste stream and the RBRC program provides an environmentally conscious alternative.

RBRC in cooperation with Black & Decker and other battery users, has established programs in the United States and Canada to facilitate the collection of spent Lithium Ion batteries. Help protect our environment and conserve natural resources by returning the spent Lithium Ion battery to an authorized Black & Decker service center or to your local retailer for recycling. You may also contact your local recycling center for information on where to drop off the spent battery, or call **1-800-8-BATTERY**.



## Service Information

All Black & Decker Service Centers are staffed with trained personnel to provide customers with efficient and reliable power tool service. Whether you need technical advice, repair, or genuine factory replacement parts, contact the Black & Decker location nearest you. To find your local service location, refer to the yellow page directory under "Tools—Electric" or call: **1-800-544-6986** or visit **www.blackanddecker.com**



## Full Two-Year Home Use Warranty

Black & Decker (U.S.) Inc. warrants this product for two years against any defects in material or workmanship. The defective product will be replaced or repaired at no charge in either of two ways.

The first, which will result in exchanges only, is to return the product to the retailer from whom it was purchased (provided that the store is a participating retailer). Returns should be made within the time period of the retailer's policy for exchanges (usually 30 to 90 days after the sale). Proof of purchase may be required. Please check with the retailer for their specific return policy regarding returns that are beyond the time set for exchanges.

The second option is to take or send the product (prepaid) to a Black & Decker owned or authorized Service Center for repair or replacement at our option. Proof of purchase may be required. Black & Decker owned and authorized Service Centers are listed under "Tools-Electric" in the yellow pages of the phone directory and on our website [www.blackanddecker.com](http://www.blackanddecker.com).

This warranty does not apply to accessories. This warranty gives you specific legal rights and you may have other rights which vary from state to state. Should you have any questions, contact the manager of your nearest Black & Decker Service Center. This product is not intended for commercial use.

**FREE WARNING LABEL REPLACEMENT:** If your warning labels become illegible or are missing, call **1-800-544-6986** for a free replacement.

**LATIN AMERICA:** This warranty does not apply to products sold in Latin America. For products sold in Latin America, check country specific warranty information contained in the packaging, call the local company or see the website for warranty information.

Imported by  
Black & Decker  
(U.S.) Inc.,  
701 E. Joppa Rd.  
Towson, MD 21286  
U.S.A.



See 'Tools-Electric'  
- Yellow Pages -  
for Service & Sales

