

Built-In Electric Wall Oven

User manual

NV51K7770S*



SAMSUNG

Regulatory Notice

1. FCC Notice

CAUTION

FCC CAUTION: Any changes or modifications not expressly approved by the party responsible for compliance could void the user's authority to operate the equipment.

This device complies with Part 15 of FCC Rules. Operation is Subject to following two conditions:

- 1) This device may not cause harmful interference, and
- 2) This device must accept any interference received including interference that cause undesired operation.

For products sold in the US and Canadian markets, only channels 1~11 are available. You cannot select any other channels.

FCC STATEMENT:

This equipment has been tested and found to comply within the limits for a Class B digital device, pursuant to part 15 of the FCC Rules. These limits are designed to provide reasonable protection against harmful interference in a residential installation.

This equipment generates, uses, and can radiate radio frequency energy and, if not installed and used in accordance with the instructions, may cause harmful interference to radio communications. However, there is no guarantee that interference will not occur in a particular installation. If this equipment does cause harmful interference to radio or television reception, which can be determined by turning the equipment off and on, the user is encouraged to try to correct the interference by one or more of the following measures:

- Reorienting or relocating the receiving antenna
- Increasing the separation between the equipment and receiver
- Connecting the equipment to an outlet that is on a different circuit than the radio or TV
- Consulting the dealer or an experienced radio/TV technician for help.

Regulatory Notice

FCC RADIATION EXPOSURE STATEMENT:

This equipment complies with FCC radiation exposure limits set forth for an uncontrolled environment. This equipment should be installed and operated so there is at least 8 inches (20 cm) between the radiator and your body. This device and its antenna(s) must not be co-located or operated in conjunction with any other antenna or transmitter.

2. IC Notice

The term “IC” before the radio certification number only signifies that Industry Canada technical specifications were met. Operation is subject to the following two conditions: (1) this device may not cause interference, and (2) this device must accept any interference, including interference that may cause undesired operation of the device.

This Class B digital apparatus complies with Canadian ICES-003. For products sold in the US and Canadian markets, only channels 1~11 are available. You cannot select any other channels.

IC RADIATION EXPOSURE STATEMENT:

This equipment complies with IC RSS-102 radiation exposure limits set forth for an uncontrolled environment. This equipment should be installed and operated so there is at least 8 inches (20 cm) between the radiator and your body. This device and its antenna(s) must not be co-located or operated in conjunction with any other antenna or transmitter.

Contents

Important safety instructions	5	Using the gliding rack	40
Introducing your new oven	18	Using the divider	41
Overview	18	Using the clean feature	41
What's included with your oven	18	Settings	48
Before you begin	19	Using the Sabbath feature	50
Energy saving tips	19	Maintaining your appliance	51
Water reservoir	19	Care and cleaning of the oven	51
Operating the oven	20	Removing the oven doors	53
Control panel	20	Replacing the oven doors	54
Display	21	Changing the oven light	55
Setting the temperature	21	Troubleshooting	56
Control Lockout	22	Troubleshooting	56
Kitchen Timer	23	Information codes	59
Timed cooking	24	Warranty (U.S.A)	60
Delay Start	25	Warranty (CANADA)	61
Using the Temp probe	26	Open Source Announcement	63
Twin cooking mode temperature setting ranges	27		
Oven functions	28		
Using the healthy cook feature	34		
Using the gourmet cook feature	36		
Using the smart control feature	37		
Using the oven racks	38		

Important safety instructions

Read and follow all instructions before using your oven to prevent the risk of fire, electric shock, personal injury, or damage when using the oven. This guide does not cover all possible conditions that may occur. Always contact your service agent or the manufacturer about problems that you do not understand.

WHAT YOU NEED TO KNOW ABOUT SAFETY INSTRUCTIONS

Warnings and important safety instructions in this manual do not cover all possible conditions and situations that may occur. It is your responsibility to use common sense, caution, and care when installing, maintaining, and operating your oven.

Important safety symbols and precautions

What the icons and signs in this user manual mean:

WARNING









Hazards or unsafe practices that may result in **severe personal injury or death**.

CAUTION

Hazards or unsafe practices that may result in **minor personal injury or property damage**.

CAUTION

To reduce the risk of fire, explosion, electric shock, or personal injury when using your oven, follow these basic safety precautions.

-  Do NOT attempt.
-  Do NOT disassemble.
-  Do NOT touch.
-  Follow directions explicitly.
-  Unplug the power plug from the wall socket.
-  Make sure the machine is grounded to prevent electric shock.
-  Call a Samsung service center for help.
-  Note

These warning signs are here to prevent injury to you and others. Please follow them explicitly.

After reading this section, keep it in a safe place for future reference.

SAVE THESE INSTRUCTIONS

Important safety instructions



STATE OF CALIFORNIA PROPOSITION 65 WARNING (US ONLY)

WARNING : This product contains chemicals known to the State of California to cause cancer and birth defects or other reproductive harm.

FOR YOUR SAFETY

When using electrical appliances, you should follow basic safety precautions, including the following:

CAUTION

- Use this appliance only for its intended purpose as described in this Owner's Manual.
- Potentially hot surfaces include the oven vent opening, surfaces near the opening, and crevices around the oven door.
-  **Proper Installation** - Be sure your appliance is properly installed and grounded by a qualified technician.
-  **User servicing** - Do not repair or replace any part of the appliance unless specifically recommended in this manual. All other servicing should be referred to a qualified technician.

 Always disconnect the power to the appliance before servicing by removing the fuse or switching off the circuit breaker.

-  **Do not enter the oven.**
- **Do not leave children alone.** Never leave children alone or unattended in an area where this appliance is in use. They should never be allowed to sit or stand on any part of the appliance.
- **Never use your appliance for warming or heating the room.**
- **Do not use water on grease fires.** Turn off the oven to avoid spreading the flames. Smother the fire or flames by closing the door or use a dry chemical, baking soda, or foam-type extinguisher.
- Avoid scratching or striking the glass doors and the control panel. Doing so may lead to glass breakage. Do not cook on a product with broken glass. Shock, fire, or cuts may occur.

SAVE THESE INSTRUCTIONS

-
- ❏ If there is a fire in the oven during self-cleaning, turn the oven off and wait for the fire to go out. Do not force the door open. The introduction of fresh air at self-cleaning temperatures may lead to a burst of flame from the oven. Failure to follow these instructions may result in severe burns.
 - If the oven is heavily soiled with oil, self-clean the oven before using the oven again. Leaving the oil in place creates a risk of fire.
 - Wipe up heavy soil on the oven bottom with a paper towel or rag before self-cleaning. Self-cleaning the oven when there is heavy soil on the oven bottom requires longer cleaning cycles and produces more smoke.
 - ★ **Storage in or on the appliance.** Do not store flammable materials in the oven or near the surface units. Be sure all packing materials are removed from the appliance before operating it. Keep plastics, clothes, and paper away from parts of the appliance that may become hot.
 - **Wear proper apparel.** Never wear loose-fitting or hanging garments while using the appliance.

-
- ★ **Use only dry potholders.** Placing moist or damp potholders on hot surfaces may result in burns from steam. Do not let the potholder touch hot heating elements. Do not use a towel or other bulky cloth instead of a potholder.
 - Teach children not to play with the controls or any other part of the oven.
 - For your safety, do not use high-pressure water cleaners or steam jet cleaners to clean any part of the oven.
 - If the power cord is damaged, it must be replaced by the manufacturer, its service agent, or similarly qualified persons to avoid creating a hazard.
 - The appliance is not intended for use by persons (including children) with reduced physical, sensory or mental capabilities, or lack of experience and knowledge, unless they have been given supervision or instruction concerning use of the appliance by a person responsible for their safety.

SAVE THESE INSTRUCTIONS

Important safety instructions

ELECTRICAL SAFETY

- ★ Use only the factory installed flexible power cord to connect to the power supply. Do not use a 3rd party power supply cord kit.
- The appliance should be serviced only by qualified service personnel. Repairs carried out by unqualified individuals may cause injury or a serious malfunction. If your appliance is in need of repair, contact a Samsung authorized service center. Failure to follow these instructions may result in damage and void the warranty.
- Flush - mounted appliances may be operated only after they have been installed in cabinets and workplaces that conform to the relevant standards. This ensures that the appliances are installed in compliance with the appropriate safety standards.
- If your appliance malfunctions or if fractures, cracks, or splits appear:
 - Switch off the oven.
 - Unplug the oven from the AC wall outlet.
 - Contact your local Samsung service center.

⚠ WARNING

- Ensure that the appliance is switched off before replacing the lamp to avoid the possibility of electric shock.

CHILD SAFETY

⚠ WARNING

- This appliance is not intended for use by young children or infirm persons without the adequate supervision of a responsible adult.
- Young children should be supervised to ensure that they do not play with the appliance.
- Keep children away from the door when opening or closing it as they may bump themselves on the door or catch their fingers in the door.
- During self-cleaning, the surfaces may get hotter than usual. Keep small children away from the oven when it is in the self-cleaning mode.

⚠ WARNING

Accessible parts may become hot during use. To avoid burns, young children should be kept away.

SAVE THESE INSTRUCTIONS

OVEN

- ❑ • **DO NOT TOUCH THE HEATING ELEMENTS OR INTERIOR SURFACES OF THE OVEN.** Heating elements may be hot even though they are dark in color. Interior surfaces of an oven become hot enough to cause burns. During and after use, do not touch or let clothing or other flammable materials contact the heating elements or interior surfaces of the oven until they have had sufficient time to cool. Other surfaces of the appliance may become hot enough to cause burns. Among these surfaces are oven vent openings and surfaces near these openings, the oven door, and the window of the oven door.
 - **Do not heat unopened food containers.** The build-up of pressure may cause the container to burst and result in injury.
- ❑ • **Do not use the oven to dry newspapers.** If overheated, newspapers can catch fire.
- **Do not use the oven for a storage area.** Items stored in an oven can ignite.

- ★ • **Use care when opening the door.** Let hot air or steam escape before you remove food from or put food into the oven.
- **Protective liners.** Do not use aluminum foil to line the oven bottoms, except as suggested in this manual. Improper installation of these liners may result in a risk of electric shock or fire.
- **Keep oven vent ducts unobstructed.** The oven vent is located above the right rear surface unit. This area could become hot during oven use. Never block this vent or place plastic or heat-sensitive items on it.
- **Placement of oven racks.** Always place oven racks in the desired location while the oven is cool. If the rack must be moved while the oven is hot, use potholders. Do not let the potholders come in contact with the hot heating element in the oven.
- ❑ • Do not allow aluminum foil or a meat probe to contact the heating elements.

SAVE THESE INSTRUCTIONS

Important safety instructions

- ❑ • **During use, the appliance becomes hot.**
Care should be taken to avoid touching heating elements inside the oven.
- Do not use harsh abrasive cleaners or sharp metal scrapers to clean the oven door glass. They can scratch the surface which may result in the glass shattering.

⚠ CAUTION

Do not attempt to operate the oven during a power failure.

If the power fails, always turn the oven off. If the oven is not turned off and the power returns, the oven may begin to operate again. Food left unattended could catch fire or spoil.

SELF-CLEANING OVENS

- ❑ • **Do not clean the door gasket.** The door gasket is essential for a good seal. Care should be taken not to rub, damage, or move the gasket.
- ★ • **Never keep pet birds in the kitchen.** Birds are extremely sensitive to the fumes released during an oven self-clean cycle. Fumes may be harmful or fatal to birds. Move birds to a well-ventilated room.
- **Clean only the parts listed in this manual in the self-clean cycle.** Before self-cleaning the oven, remove the divider, rack, utensils, and any food.
- Before operating the self-clean cycle, wipe grease and food soils from the oven. Excessive amounts of grease may ignite, leading to smoke damage to your home.
- Do not use any commercial oven cleaner or oven liner protective coating of any kind in or on the outside of the oven.
- Remove the nickel oven shelves from the oven before you begin the self-cleaning cycle or they may discolor.

SAVE THESE INSTRUCTIONS

-
- ★ If the self-cleaning mode malfunctions, turn the oven off and disconnect the power supply. Have it serviced by a qualified technician.
 - Excess spillage must be removed before you run the self-cleaning cycle.

VENTILATING HOOD

- ★ **Clean ventilating hoods frequently.** Do not let grease accumulate on the hood or filter.
- When flaming foods under the hood, turn the fan on.**



CRITICAL INSTALLATION WARNINGS

⚠ WARNING

- ★ This appliance must be installed by a qualified technician or service company.
 - Failing to have a qualified technician install the oven may result in electric shock, fire, an explosion, problems with the product, or injury.
- Unpack the oven, remove all packaging material and examine the oven for any damage such as dents on the interior or exterior of the oven, broken door latches, cracks in the door, or a door that is not lined up correctly. If there is any damage, do not operate the oven and notify your dealer immediately.
- Plug the power cord into a properly grounded outlet with the proper configuration. Your oven should be the only item connected to this circuit.
- Keep all packaging materials out of the reach of children. Children may use them for play and injure themselves.

SAVE THESE INSTRUCTIONS

Important safety instructions

-  This appliance must be properly grounded.
- Do not ground the appliance to a gas pipe, plastic water pipe, or telephone line.
 - This may result in electric shock, fire, an explosion, or problems with the product
- Do not cut or remove the ground prong from the power cord under any circumstances.
- Connect the oven to a circuit that provides the correct amperage.
-  Do not install this appliance in a humid, oily or dusty location, or in a location exposed to direct sunlight or water (rain drops).
 - This may result in electric shock or fire.
- Do not use a damaged power cord or loose wall socket.
 - This may result in electric shock or fire.
- Do not pull or excessively bend the power cord.
- Do not twist or tie the power cord.
- Do not hook the power cord over a metal object, place a heavy object on the power cord, or insert the power cord between objects.
 - This may result in electric shock or fire.

-  If the power cord is damaged, contact your nearest Samsung service center.

CRITICAL USAGE WARNING

CAUTION

-  If the appliance is flooded by any liquid, please contact your nearest Samsung service center. Failing to do so may result in electric shock or fire.
- If the appliance produces a strange noise, a burning smell, or smoke, unplug the power plug immediately and contact your nearest Samsung service center.
 - Failing to do so may result in electric shock or fire
- In the event of a gas leak (such as propane gas, LP gas, etc.), ventilate the area immediately. Do not touch the power cord. Do not touch the appliance.
 - A spark may result in an explosion or fire.
- Take care not to contact the oven door, heating elements, or any of the other hot parts with your body while cooking or just after cooking.
 - Failing to do so may result in burns.

SAVE THESE INSTRUCTIONS

-
- ★ • If materials inside the oven should ignite, keep the oven door closed, turn the oven off and disconnect the power cord, or shut off power at the fuse or circuit breaker panel. If the door is opened, the fire may spread.
 - Always observe safety precautions when using your oven. Never try to repair the oven on your own - there is dangerous voltage inside. If the oven needs to be repaired, contact an authorized Samsung service center near you.
 - If you use the appliance when it is contaminated by foreign substances such as food waste, it may result in a problem with the appliance.
 - Take care when removing the wrapping from food taken out of the appliance.
 - If the food is hot, hot steam may be emitted abruptly when you remove the wrapping and this may result in burns.

-
- ✗ • Do not attempt to repair, disassemble, or modify the appliance yourself.
 - Since a high voltage current enters the product chassis, it may result in electric shock or fire.
 - When a repair is needed, contact your nearest Samsung service center.
 - ✍ • If any foreign substance such as water has entered the appliance, contact your nearest Samsung service center.
 - Failing to do so may result in electric shock or fire.
 - ✗ • Do not touch the power cord with wet hands.
 - This may result in electric shock.
 - Do not turn the appliance off while an operation is in progress.
 - This may cause a spark and result in electric shock or fire.
 - Do not let children or any person with reduced physical, sensory, or mental capabilities use this appliance unsupervised.
 - Make sure that the appliance's controls and cooking areas are out of the reach of children.
 - Failing to do so may result in electric shock, burns, or injury.

SAVE THESE INSTRUCTIONS

Important safety instructions

- ❑ • Do not touch the inside of the appliance immediately after cooking. The inside of the appliance will be hot.
 - Failing to do so may result in burns.
- Do not use or place flammable sprays or objects near the oven.
 - Flammable items or sprays can cause fires or an explosion.
- Do not insert fingers, foreign substances, or metal objects such as pins or needles into inlets, outlets, or holes. If foreign substances are inserted into any of these holes, contact your product provider or nearest Samsung service center.
- Do not tamper with or make any adjustments or repairs to the door. Under no circumstances should you remove the door or outer shell of the oven.
- Do not store or use the oven outdoors.
- Never use this appliance for purposes other than cooking.
 - Using the appliance for any purpose other than cooking may result in fire.
- ❑ • Open the cap or stopper of sealed containers (herb tonic tea bottle, baby bottle, milk bottle and so on) before heating them. Make a hole in food items that have shells (eggs, chestnuts, etc) with a knife before cooking them.
 - Failing to do so may result in burns or injury.
- Never heat plastic or paper containers and do not use them for cooking.
 - Failing to do so may result in fire.
- Do not heat food wrapped in paper from magazines, newspapers, etc.
 - This may result in fire.
- Do not open the door when the food in the oven is burning.
 - If you open the door, it causes an inflow of oxygen and may cause the food to ignite.

SAVE THESE INSTRUCTIONS

-
- ❏ Do not apply excessive pressure to the door or the inside of the appliance. Do not strike the door or the inside or the appliance.
 - Hanging on to the door may result in the product falling and cause serious injury.
 - If the door is damaged, do not use the appliance. Contact a Samsung service center.
 - Do not hold food in your bare hands during or immediately after cooking.
 - Use cooking gloves. The food may be very hot and you could burn yourself.
 - As the handle and oven surfaces may be hot enough to cause burns after cooking, use cooking gloves to protect your hands from burns.

USAGE CAUTIONS

⚠ CAUTION

- ★ If the surface is cracked, turn the appliance off.
 - Failing to do so may result in electric shock.
- Dishes and containers can become hot. Handle with care.
- Hot foods and steam can cause burns. Carefully remove container coverings, directing the steam away your hands and face.
- Remove lids from baby food jars before heating. After heating baby food, stir well to distribute the heat evenly. Always test the temperature by tasting before feeding the baby. The glass jar or the surface of the food may appear to be cooler than the interior, which can be hot enough to burn an infant's mouth.
- Take care as beverages or food may be very hot after heating.
 - Especially when feeding a child, make sure the food or beverage has cooled sufficiently.

SAVE THESE INSTRUCTIONS

Important safety instructions

- ★ • Take care when heating liquids such as water or other beverages.
 - Make sure to stir during or after cooking.
 - Avoid using a slippery container with a narrow neck.
 - Wait at least 30 seconds after heating before removing the heated liquid.
 - Failing to do so may result in an abrupt overflow of the contents and cause burns.
- ☒ • Do not stand on top of the appliance or place objects (such as laundry, an oven cover, lighted candles, lighted cigarettes, dishes, chemicals, metal objects, etc.) on the appliance.
 - Items, such as a cloth, may get caught in the door.
 - This may result in electric shock, fire, problems with the product, or injury.
- Do not operate the appliance with wet hands.
 - This may result in electric shock.
- Do not spray volatile substances such as insecticide onto the surface of the appliance.
 - As well as being harmful to humans, it may also result in electric shock, fire, or problems with the product.
- ☒ • Do not put your face or body close to the appliance while cooking or when opening the door just after cooking.
 - Take care that children do not come too close to the appliance.
 - Failing to do so may result in children burning themselves.
- Do not place food or heavy objects over the edge of the oven door.
 - If you open the door, the food or object may fall and this may result in burns or injury.
- Do not abruptly cool the door, the inside of the appliance, or a dish by pouring water over it during or just after cooking.
 - This may result in damage to the appliance. The steam or water spray may result in burns or injury.
- Do not operate while empty except for self-cleaning.
- Do not defrost frozen beverages in narrow-necked bottles. The bottles can break.
- Do not scratch the glass of the oven door with a sharp object.
 - This may result in the glass being damaged or broken.

SAVE THESE INSTRUCTIONS

-
- ❏ Do not store anything directly on top of the appliance when it is in operation.
 - Do not use sealed containers. Remove seals and lids before cooking. Sealed containers can explode due to the build up of pressure even after the oven has been turned off.
 - Take care that food you are cooking in the oven does not come into contact with the heating element.
 - This may result in fire.
 - Do not over-heat food.
 - Overheating food may result in fire.
 - Use caution when opening or closing the door. Your fingers may be pinched, resulting in physical injury.
 - The door reveals wires at the bottom for connecting LED lights. So use caution not to pull or cut the wires when handling the door.

CRITICAL CLEANING WARNINGS

⚠ CAUTION

- ★ Do not clean the appliance by spraying water directly on to it.
- Do not use benzene, thinner, or alcohol to clean the appliance.
 - This may result in discoloration, deformation, damage, electric shock, or fire.
- Take care not to hurt yourself when cleaning the appliance (externally or internally).
 - You may hurt yourself on the sharp edges of the appliance.
- Do not clean the appliance with a steam cleaner.
 - This may result in corrosion.
- Keep the inside of the oven clean. Food particles or spattered oils stuck to the oven walls or floor can cause paint damage and reduce the efficiency of the oven.

SAVE THESE INSTRUCTIONS

Introducing your new oven

Overview

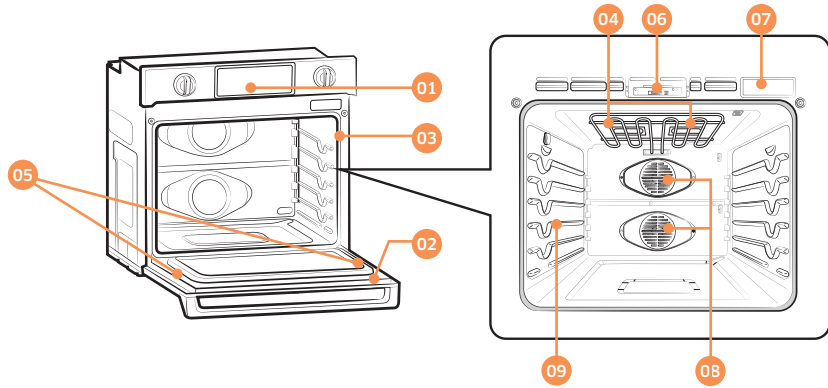

- 01 Oven control panel
- 02 Oven door
- 03 Oven gasket
- 04 Halogen lamp *
- 05 Door LED light
- 06 Door latch
- 07 Water reservoir
- 08 Convection fan
- 09 Shelf position

What's included with your oven

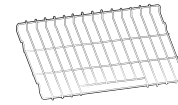

Wire racks (2)*

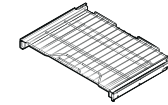

Gliding rack (1)*

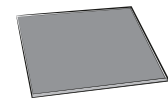

Divider (1)*

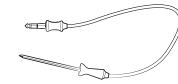

Temp probe (1)*

NOTE

If you need an accessory marked with a *, you can buy it from the Samsung Contact Center (1-800-726-7864).

Before you begin

Clean the oven thoroughly before using it for the first time. Then, remove the accessories, set the oven to Bake, and then run the oven at 400 °F for 1 hour. There will be a distinctive odor. This is normal. Ensure your kitchen is well ventilated during this conditioning period.

Energy saving tips

- During cooking, the oven door should remain closed except when you turn food over. Do not open the door frequently during cooking to maintain the oven temperature and to save energy.
- If cooking time is more than 30 minutes, you can switch the oven off 5-10 minutes before the end of the cooking time to save energy. The residual heat will complete the cooking process.
- To save energy and reduce the time needed for re-heating the oven, plan oven use to avoid turning the oven off between cooking one item and the next.
- Whenever possible, cook more than one item at a time.

Water reservoir

The water reservoir is used for the Steam Bake, Steam Roast and Hybrid Clean functions and also to remove water scale that may form on the oven walls, especially after Steam Baking, Steam Roasting, and Hybrid cleaning. Fill it with water in advance of steam cooking or descaling.

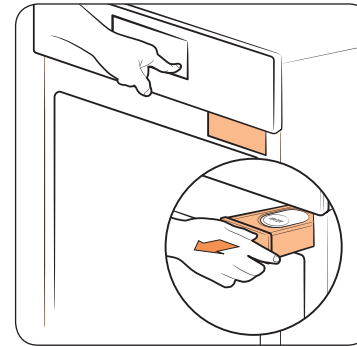

1. Locate the water reservoir. The water reservoir is on the right side of the oven, just above the oven opening. Touch **Reservoir**  on the control panel. The oven ejects the water reservoir. Grasp the front of the reservoir, and then slide it out to remove.

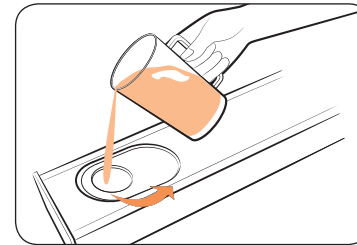

2. Open the reservoir cap, and then fill the reservoir with 22 oz (650ml) of drinkable water.

NOTE

You can open the reservoir by removing the rubber cap or by removing the clear plastic top.

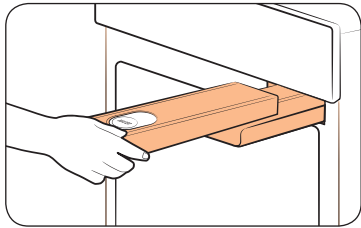

3. Replace the cap or the clear plastic top, and then slide the water reservoir back into the reservoir slot.
4. Push the reservoir in. There will be soft click when it is in place correctly. Touch **Reservoir** . The oven retracts the water reservoir.
5. Close the oven door.

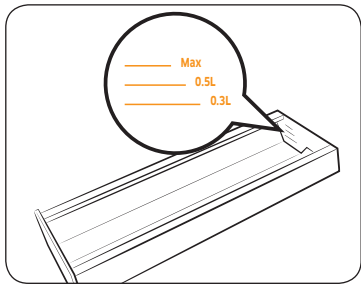

- NOTE**
Do not exceed the max line.

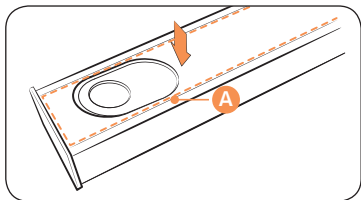

- NOTE**
Make sure the cap and the upper portion of the water reservoir (**labeled A**) are closed before using the oven.

CAUTION

The water reservoir becomes hot during cooking. Make sure you wear oven gloves to remove or refill the water reservoir.

Operating the oven

Control panel

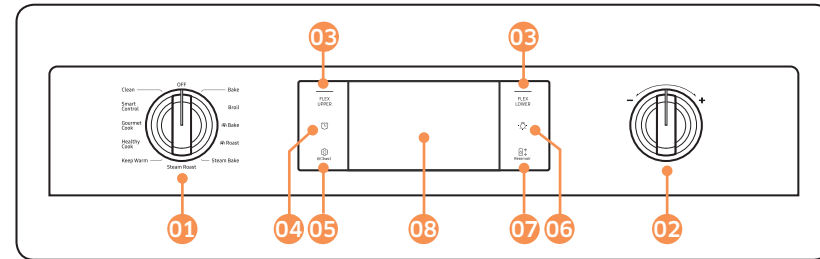

- 01 Mode knob:** Use to select mode of single or twin oven.
- **Single:** Bake, Broil, Bake (Convection Bake), Roast (Convection Roast), Steam Bake, Steam Roast, Keep Warm, Healthy Cook, Gourmet Cook, Smart Control, Clean.
 - **FLEX Upper:** Broil, Bake (Convection Bake), Roast (Convection Roast), Steam Bake.
 - **FLEX Lower:** Bake, Bake (Convection Bake).
- 02 Temp knob:** Use to set the temperature for the oven or the flex upper or lower compartments.
- 03 FLEX UPPER, FLEX LOWER:** Use to display the Flex upper or Flex lower oven mode screen on the display. Touching here does not turn the ovens on or off. It only displays their current status.
- 04 Timer** : Use to display the set Timer screen.
- 05 Setting and Control Lockout** : Use to display the Setting screen. If you touch and hold this key for 3 seconds, all oven functions will be disabled.
- 06 Lamp** : Use to turn the oven light on or off.
- 07 Reservoir** : Touch to open the water reservoir.
- 08 Display:** Swipe to navigate through the menus and tap to select a desired setting.

NOTE

If you tap or touch the display while wearing plastic or oven gloves, the display will not operate properly. Take the gloves off first, and then tap with a bare finger.

Display

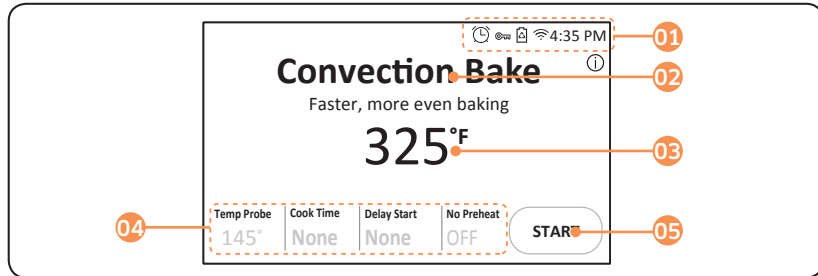

01 Indicator area

- **Timer** (🕒): When the timer is set, the timer indicator is displayed. When more than 2 timers are set, the number of set timers is shown.
- **Door lock** (🔒): Displayed when the oven door is locked.
- **Wi-Fi** (📶): Shows Wi-Fi signal strength in 5 steps.
- **12 hour energy saving** (🌙): Displayed when 12 hour energy saving is turned on.
- **Current time**: The current time is displayed.

02 Mode: The current or selected menu is displayed with a mode description.

03 Temperature: The current or selected temperature is displayed. When you tap this area, the temperature adjustment screen is displayed.

04 Information area

- **Temp Probe**: The set temperature of the temp probe is displayed. When you tap this area, the Temp Probe screen is displayed.
- **Cook Time**: The cooking time is displayed. When you tap this area, the cooking time screen is displayed.
- **Delay Start**: The delay start time is displayed. When you tap this area, the Delay Start screen is displayed.
- **No preheat**: Indicates if the No Preheat feature is on or off. (Only displayed when you are using the Convection Bake or Convection Roast mode.)
- **Steam**: The steam level is displayed. When you tap this area, the steam level screen is displayed. (Only displayed when you are using the Steam Bake or Steam Roast mode.)

05 START: Tap to start the oven using the displayed settings.

Setting the temperature

This oven provides three methods to set the temperature.

Temperature knob

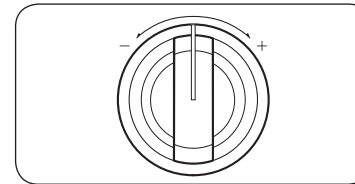

- Turn the Temperature knob clockwise (+) or counterclockwise (-) and then release. The temperature will rise or fall by 5 °F.
- To change the temperature quickly by more than 5 °F, turn and hold the knob at the + or - position.

Numeric pad

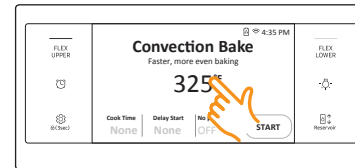

- Tap the temperature area to display the numeric pad.
- Tap the numbers in the numeric pad to set the temperature.
- Tap **OK**

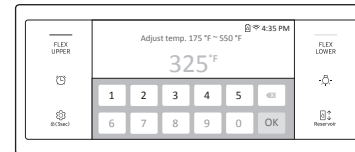

Operating the oven

Wheel picker

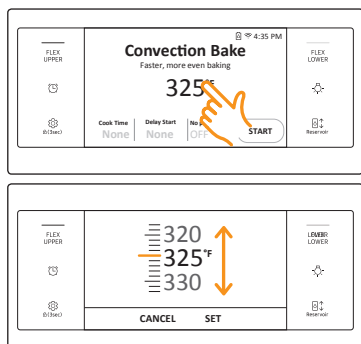

- Tap and hold the temperature area. The wheel picker appears.
- Set the temperature you want by flicking the wheel picker on the screen.
- Tap **OK**

Control Lockout

Control Lockout lets you lock the buttons on the touch pad so they cannot be activated accidentally. Control Lock also locks the oven door so it cannot be opened. You can only activate Control Lockout when the oven is in standby mode.

How to activate the Control Lockout feature

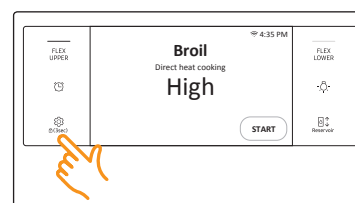

1. Cancel or turn off all functions.
2. Touch **Control Lockout** for 3 seconds.

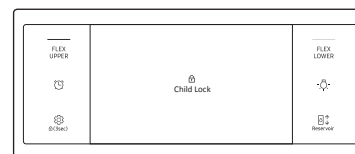

3. The display will change to the control lock screen and the control lock confirmation will appear at the bottom of the screen.

NOTE

- Control Lockout is available only when the oven temperature is under 400 °F.
- All other functions must be cancelled before you activate Control Lockout.

How to unlock the controls

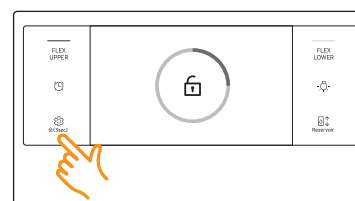

1. Touch **Control Lockout** for 3 seconds. The control lock confirmation and the lock icon will disappear from the display.

NOTE

It may take up to 10 seconds for the door to unlock.

Kitchen Timer

The kitchen timer serves as an extra timer that will beep when the set time has elapsed. It does not start or stop cooking functions. You can use the kitchen timer with any of the other oven functions.

How to set the timer

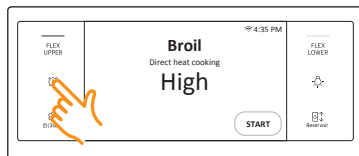

1. Touch **Timer** . The display will be changed to the timer screen.

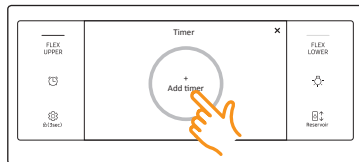

2. Tap **+ Add timer**.

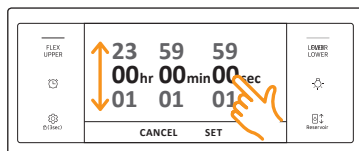

3. Flick screen or tap the time area to set time. (You can set the timer for any amount of time from 1 sec to 24 hr).

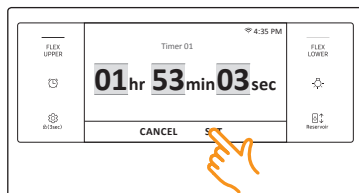

4. Tap **SET**. The timer is displayed on the screen.

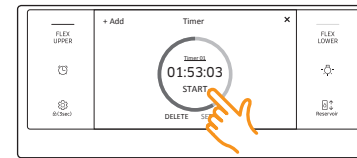

5. Tap **START**. When the set time has elapsed, the oven will beep and the display will show the Timer has finished.

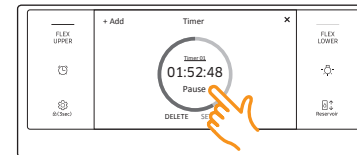

- You can pause, reset, or delete the timer at any time by touching the screen.

How to change timer name

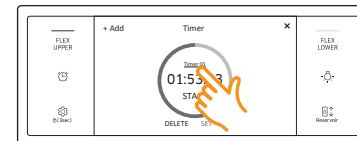

You can change the timer name to identify what you are timing, for example, a chicken defrosting.

1. Tap the timer name area.



- The keyboard appears.

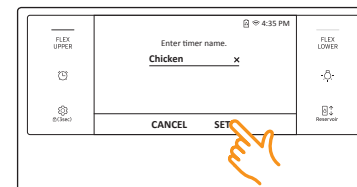

2. Enter the new timer name, and then tap **SET**.

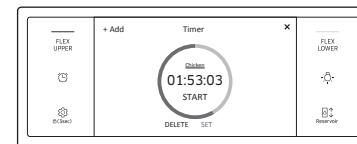

- The display shows the changed timer name.

Operating the oven

Timed cooking

In timed cooking mode, the oven turns on immediately and cooks for the length of time you select.

At the end of the cooking time, the oven turns off automatically.

- You can use the timed cooking feature only with another cooking operation. (Bake, Convection Bake, Convection Roast, Steam Bake, Steam Roast, Convection Broil, Healthy Cook, Bread Proof).

How to set the oven for timed cooking



- Turn Oven Mode knob to the cooking operation you want.
- Tap **Cook Time**. The display will change to the cooking time screen.

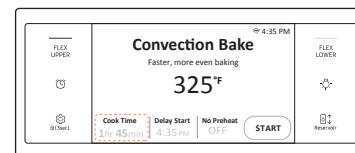
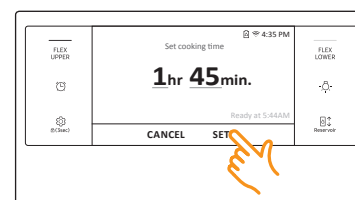
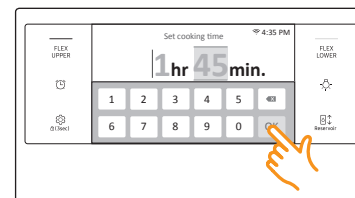
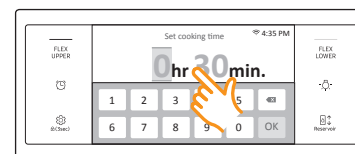

- Flick the screen or tap the time area to set the cooking time. If you tap the time area, the numeric pad appears. Tap numbers in the numeric pad to set the cooking time. (You can set the cooking time for any amount of time from 1 minute to 9 hours and 59 minutes).

- Tap **SET**. The cooking time screen closes. The cooking time is displayed in the Cook Time area on the screen.
- You can cancel a cook time at any time by setting the Cook Time to 0 minutes.

NOTE

See pages 31 through 33 for basic baking and broiling instructions.

CAUTION

Use caution with the timed cooking or delay start features. You can use these features to cook cured or frozen meats and most fruits and vegetables. For food that can easily spoil, such as milk, eggs, and unfrozen or fresh fish, meat, or poultry, chill them in the refrigerator first. Even when chilled, they should not stand in the oven for more than 1 hour before cooking begins, and should be removed promptly when cooking is completed. Eating spoiled food can result in sickness from food poisoning.

Delay Start

In the delay timed cooking mode, the oven's timer turns the oven on at a time you select in advance. You can have the oven turn off automatically after a set time has elapsed by setting the Timed Cooking function as well.

- You can use the delay start feature only with another cooking operation (Bake, Convection Bake, Convection Roast, Steam Bake, Steam Roast, Healthy Cook, Self Clean).
- You can set the oven for a delay start before setting other cooking operations.
- The clock must be set to the current time.

How to set the oven for delay timed cooking

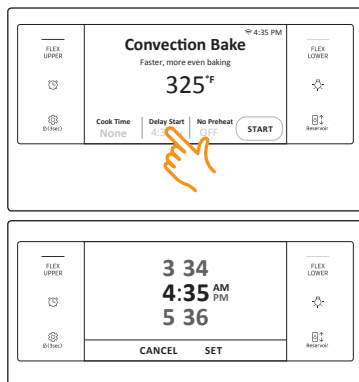

- Position the oven rack(s) and place the food in the oven.
- Turn the Oven Mode knob to the cooking operation you want.
- Set the cooking time if you want the oven to turn off automatically after a set time. (See the **Timed cooking** section on page 24).
- Tap **Delay Start**. The current time is displayed as the first entry.

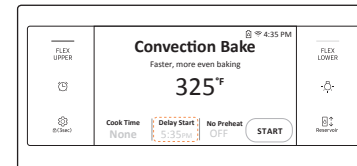
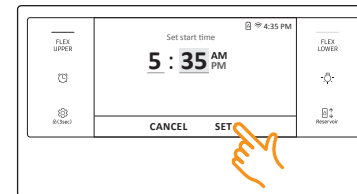
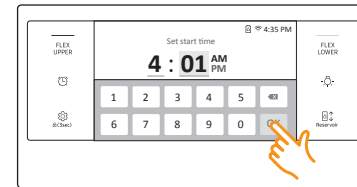
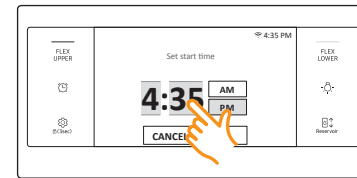

- Flick the screen or tap the time area to set the start time. If you tap the time area, the numeric pad appears. Tap numbers in the numeric pad to set the time you want the oven to start.

- Tap **SET**. The Delay Start screen closes. The start time, and, if you set it, the cooking time, is displayed on the screen.

NOTE

See pages 31 through 33 for basic baking and broiling instructions.

Operating the oven

Using the Temp probe

For many foods, especially roasts and poultry (beef, chicken, turkey, pork, lamb, etc), measuring the internal temperature is the best way to determine if the food is properly cooked. The Temp probe lets you cook meat to the exact internal temperature you want, taking the guess work out of determining whether a piece of meat is done or not. This function can be used with Bake, Convection Bake, or Convection Roast.

After the internal temperature of the food reaches 100 °F, the increasing internal temperature will be shown in the display.

How to use the Temp probe

1. Push the tip of the Temp probe into the meat as fully as possible, so that the tip is in the center of the meat.

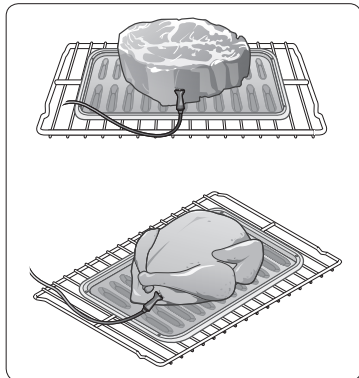

- Insert the probe completely into the meat as shown in the illustrations. It should not touch bone, fat, or gristle.
- If you do not fully insert the probe into the meat, the Temp Probe function will not work correctly because the probe will sense the oven temperature, not the temperature of the meat.
- For bone-in meats, insert the probe into the center of the lowest and thickest portion of the piece.
- For whole poultry (turkey, large chickens, etc.), insert the probe into the thickest part of the inner thigh, parallel to the leg.
- If you activate the Keep Warm function to keep the meat warm after you have cooked it using the Temp Probe function, the meat's internal temperature will exceed the temperature you want.

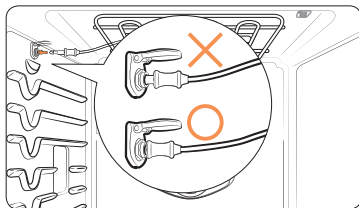

2. Insert the temp probe plug into the socket on the top side wall of the oven as far as it will go.
 3. Turn the upper or lower oven mode knob to select the desired cooking mode (Bake, Convection Bake or Convection Roast). Set the cooking temperature. (See pages 21 and 31.)
 4. Tap **Temp Probe** to set the desired internal temperature.
 5. Set the desired internal temperature using the numeric pad.
- | | |
|------------------------|------------------|
| Available temperatures | 100 °F to 200 °F |
|------------------------|------------------|
6. If you want to use the Cook time or Delay start, set each function.
 7. Tap **START**.
 8. When the desired internal temperature is reached, the function automatically stops and an alarm sounds.

⚠ CAUTION

To protect the Temp probe's tip, be careful not to insert the probe so that the tip protrudes through the surface of the meat. Make sure that the tip is in or near the center of the meat.

⚠ CAUTION

- Do not store the probe in the oven.
- Do not leave the probe inside the oven during a self-cleaning or broiling cycle. You can permanently damage the probe and it will no longer work.
- To avoid breaking the probe's tip, defrost your food completely.
- Do not use tongs when inserting or removing the probe. Tongs can damage the probe.
- Use the Temp probe for Temp Probe function cooking only. Do not use the Temp probe for any other purpose.

📖 NOTE

- If you remove the Temp probe while the Temp Probe function is operating or insert the Temp probe while baking or cooking normally, cooking will stop after 1 minute.
- If you use the probe to cook frozen food, there are times when it cannot be detected. (The probe icon won't appear in the display.)

Temp probe table

Type of Food		Internal temperature
Beef / Lamb	Rare	140 °F
	Medium	160 °F
	Well done	170 °F
Pork		170 °F
Poultry		180-185 °F

NOTE

If you cover the meat with aluminum foil and allow it to stand for 10 minutes after cooking, the Internal temperature will rise 5-10 degrees.

Removing the Temp probe

Remove the temp probe plug from the socket.

CAUTION

After cooking, the Temp probe is hot enough to cause burns. Let it cool sufficiently before attempting to remove it.

Twin cooking mode temperature setting ranges

Using the divider you can divide the oven into two compartments, flex upper and flex lower. This is also called twin mode. When you use the flex upper and flex lower compartments at the same time, each oven has a minimum and maximum amount of power available and consequently minimum and maximum temperature settings.

Oven temperatures in the flex lower compartment also limit broil settings in the flex upper compartment. The temperature and broil setting limitations are shown in the table below and on the next page.

FLEX UPPER COMPARTMENT		FLEX LOWER COMPARTMENT (Available function settings and temperatures)	
Mode	Set Temp.	Bake, Convection Bake	
		Min	Max
Broil	Hi	400 °F	480 °F
	Low	325 °F	480 °F
Convection Bake & Convection Roast	480 °F	400 °F	480 °F
	450 °F	350 °F	480 °F
	300 °F	250 °F	375 °F
	250 °F	225 °F	300 °F
	175 °F	175 °F	200 °F

NOTE

To insert the divider, see page 41.

Operating the oven

FLEX LOWER COMPARTMENT		FLEX UPPER COMPARTMENT (Available function settings and temperatures)			
Mode	Set Temp.	Broil		Convection Bake, Convection Roast	
		Low	Hi	Min	Max
Bake & Convection Bake	480 °F	O	O	400 °F	480 °F
	450 °F	O	O	350 °F	480 °F
	350 °F	O	X	275 °F	450 °F
	325 °F	O	X	275 °F	400 °F
	250 °F	X	X	225 °F	300 °F
	175 °F	X	X	175 °F	200 °F



O = Available X = Not Available

NOTE

The twin cooking mode lets you use different settings for the upper and lower compartments, such as different switch off times, cooking times, and temperatures settings.

To apply or modify settings in either compartment, tap the respective touch pad.

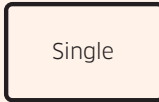
Oven functions

Oven		Oven functions
 Without a divider	Single oven	Bake, Broil, Convection Bake, Convection Roast, Steam Bake, Steam Roast, Keep Warm, Healthy Cook, Gourmet Cook, Smart Control, Clean
 With a divider	*Twin oven	Upper Broil, Convection Bake, Convection Roast, Steam Bake, Healthy Cook, Smart Control
	Lower	Bake, Convection Bake, Healthy Cook, Smart Control

* To use the twin flex oven functionality, you must insert the divider into the oven and divide it into an upper and lower compartment. See page 41.

Cooking mode

Single Mode

Turn the Oven Mode knob to select the cooking mode. Set the temperature using the Temp knob, the numeric pad, or the wheel picker. See Setting the Temperature on pages 21 and 22 and Basic Baking and Broiling Instructions starting on page 31.

Twin Flex Mode

Touch Flex Upper or Flex Lower. Turn the Oven Mode knob to select the cooking mode. Set the temperature using the Temp knob, the numeric pad, or the wheel picker. See Setting the Temperature on pages 21 and 22 and Basic Baking and Broiling Instructions starting on page 31.

Mode	Temperature range		Single oven	*Twin oven		Temp probe	No preheat
	Single oven	*Twin oven		Upper	Lower		
Bake	175 °F (80 °C) - 550 °F (285 °C)	175 °F (80 °C) - 480 °F (250 °C)	0	-	0	0	-
Broil	LO / HI	LO / HI	0	0	-	-	-
Convection Bake	175 °F (80 °C) - 550 °F (285 °C)	175 °F (80 °C) - 480 °F (250 °C)	0	0	0	0	0
Convection Roast	175 °F (80 °C) - 550 °F (285 °C)	175 °F (80 °C) - 480 °F (250 °C)	0	0	-	0	0
Steam Bake	230 °F (110 °C) - 550 °F (285 °C)	230 °F (110 °C) - 480 °F (250 °C)	0	0	-	-	-
Steam Roast	230 °F (110 °C) - 550 °F (285 °C)	230 °F (110 °C) - 480 °F (250 °C)	0	-	-	-	-
Keep Warm	**None	-	0	-	-	-	-

0 = Available - = Not Available

* To use the twin flex oven functionality, you must insert the divider into the oven and divide it into an upper and lower compartment. See page 41.

** None means that a factory set temperature is applied for the best performance. You cannot adjust this temperature.

Mode	Instruction
Bake	<ul style="list-style-type: none"> Bake is used to cook cakes, cookies, and casseroles. Always preheat the oven first. Baking temperatures and times will vary depending on the ingredients and the size and shape of the baking pan used. Dark or nonstick coatings may cook faster with more browning. <p> NOTE For performance reasons, the convection fan may turn on or off during baking.</p>
Broil	<ul style="list-style-type: none"> Broiling is a method of cooking tender cuts of meat by direct heat under the broil element of the oven. The high heat cooks quickly and gives a rich, brown outer appearance. Broil mode is best for meats, fish, and poultry up to 1 inch thick. Always preheat the oven for 5 minutes before broiling. See the Broiling recommendation guide section starting on page 30.
Convection Bake	<ul style="list-style-type: none"> Convection Bake uses a fan to circulate the oven's heat evenly and continuously within the oven. This improved heat distribution allows for even cooking and excellent results while using multiple racks at the same time. Breads and pastries brown more evenly.
Convection Roast	<ul style="list-style-type: none"> Convection Roast is good for cooking large tender cuts of meat, uncovered. The convection fan circulates the heated air evenly over and around the food. Meat and poultry are browned on all sides as if they were cooked on a rotisserie. The heated air seals in juices quickly for moist and tender results while, at the same time, creating a rich golden brown exterior.

Operating the oven

Mode	Instruction
Steam Bake	<ul style="list-style-type: none"> Steam Bake provides excellent baking conditions for breads, pastries, and desserts by increasing moisture content and improving texture and flavor. See the Steam cook recommendation guide section starting on page 31.
Steam Roast	<ul style="list-style-type: none"> Steam Roast provides excellent cooking conditions for roasted meats or poultry by maintaining a crispy surface while sealing in the juices for a moist and tender result. See the Steam cook recommendation guide section starting on page 31.
Keep Warm	<ul style="list-style-type: none"> The keep warm mode will keep cooked food warm for serving up to 3 hours after cooking has finished. You can use the keep warm mode without any other cooking operations or you can set it to activate after a timed or delay timed cooking operation. You should not use this mode to reheat cold food.

Broiling recommendation guide

The size, weight, thickness, starting temperature, and your doneness preference will affect broiling times. This guide is based on meats at refrigerator temperature. Always use a broiler pan and its grid when broiling. Always preheat the oven for 5 minutes before broiling.

Food	Doneness	Size	Thickness	Level	Rack position	Cooking time(min)	
						1st side	2nd side
Hamburgers	Medium	9 patties	3/4"	Hi	6	3:00	2:00
	Medium	9 patties	1"	Hi	6	3:20	2:20
Beef steaks	Rare	-	1"	Hi	5	5:00	4:00
	Medium	-	1- 1 1/2"	Hi	5	6:00-6:30	4:30-4:00
	Well done	-	1- 1 1/2"	Lo	4	7:00-8:00	4:00-5:00
Chicken pieces	Well done	4.5 lbs.	1/2-3/4"	Lo	3	16:00-18:00	13:00-15:00
	Well done	2 lbs.	1/2-3/4"	Lo	3 or 4	15:00-16:00	10:00-12:00
Pork chops	Well done	1 lbs.	1"	Lo	3	8:00-10:00	6:00-8:00
Fish fillets	Well done	-	1/4-1/2"	Lo	3 or 4	7:00-8:00	4:00-5:00

Steam cook recommendation guide

Steam mode	level	Foods
Steam bake	High	Rye breads, Desserts (Flan caramel)
	Med	Croissants, Pies, Reheats (Pizza, Casseroles)
	Low	Pastries
Steam Roast	High	-
	Med	Meats, Poultry
	Low	Turkey, Large meats

Basic Baking and Broiling Instructions

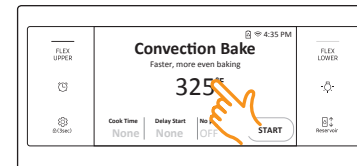
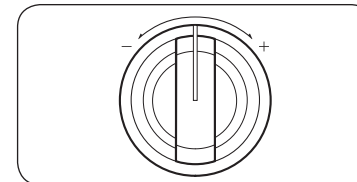
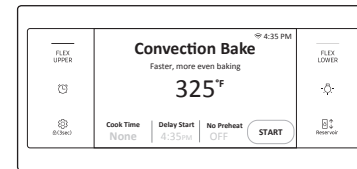
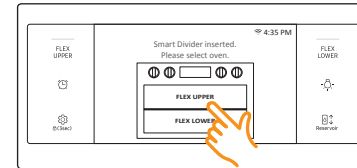

- To use Twin Flex mode, insert the divider into the oven. See page 41 for details. If you are using single mode, skip this step and go to Step 2.
- Turn the Oven Mode knob to select the desired cooking mode. If you inserted the divider, select **FLEX UPPER** or **FLEX LOWER** on the screen.
- Set the temperature you want. (See the **Setting the temperature** section on page 21.)
 - Broil mode can be set only Hi or Low.
 - Keep Warm temperatures are fixed and cannot be changed.

Operating the oven



4. Follow the steps below to use the No Preheat feature, Steam Bake, or Steam Roast. If you are not using these features, skip these steps and go to Step 5 in the next column.
 - No Preheat
 - a. If you are select Convection Bake or Convection Roast, the display will show the No preheat information. (The default is OFF).
 - b. Tap the No Preheat area. The No Preheat feature is activated and the display will show ON.

NOTE

- For best performance, we recommend cooking on a single rack.

Type	Rack Positions
Baking	3 or 4
Roasting	1 or 2

- Place food in the oven before you start cooking when using the No preheat feature.
- For best performance, preheat the oven when baking rising bakery products such as angel food cakes, bundt cakes, or puff pastries.



5. Steam Bake, Steam Roast
 - a. If you selected Steam Bake or Steam Roast, the display will show the steam level information. (The default is Medium).
 - b. Tap the Steam area to adjust the steam level. The steam level adjustment screen appears. You can set the steam level to Low, Medium, or High.
 - c. Tap **SET**. The steam level adjustment screen closes and the steam level information is displayed on the screen.

Important: You must fill the water reservoir before you start steam cooking. See the **Water reservoir** section on page 19.
5. If you want to use the Cook Time, or Delay Start function, set each function now. See pages 24 and 25 for instructions.

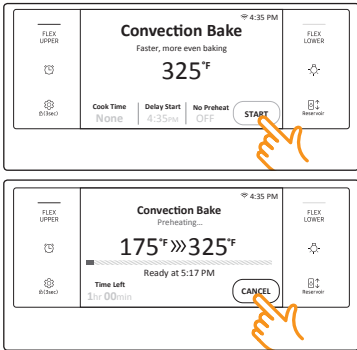

6. Tap **START** to begin cooking.
7. Tap **CANCEL** when cooking is done or if you want to cancel cooking.

How to adjust the temperature while cooking

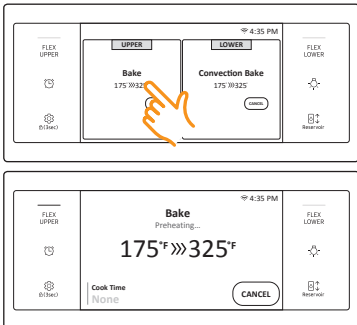

If you are using the oven in single mode, do one of the following:

- Use the oven temperature knob to adjust the temperature.
- Tap the temperature area, enter the new temperature using the numeric keypad, and then tap **OK**.
- Touch and hold the temperature area, flick the wheel picker to set the temperature, and then tap **SET**.

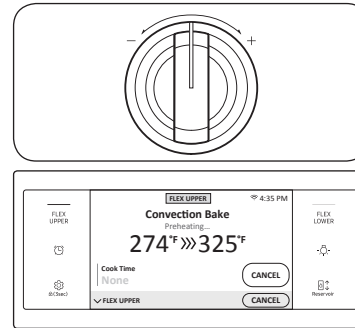

If you are using the oven in twin flex mode, tap **FLEX UPPER** or **FLEX LOWER**, and then do one of the following:

- Use the oven temperature knob to adjust the temperature.
- Tap the temperature area, enter the new temperature using the numeric keypad, and then tap **OK**.
- Touch and hold the temperature area, flick the wheel picker to set the temperature, and then tap **SET**.



- Place food in the oven after preheating if the recipe calls for it. Preheating is very important for good results when baking cakes, cookies, pastry, and breads. After the oven has reached the desired temperature, the oven will beep 6 times.
- The convection oven fan shuts off when the oven door is opened.
- DO NOT leave the door open for long periods of time while using convection cooking or you may shorten the life of the convection heating element.

Operating the oven

NOTE

- If you leave the oven door open for more than 2 minutes when the oven is on, all heating elements will shut off automatically.
- When you have finished cooking, the cooling fan will continue to run until the oven has cooled down.
- Make sure to drain the remaining water after using steam cooking. Once the oven starts draining, please wait until the draining cycle is complete.
- When a steam function is complete, you must empty the water reservoir because the remaining water can affect other cooking modes.
- If you are using an oven thermometer in the oven cavity, the temperature registered by the thermometer may differ from the actual set oven temperature.
- For performance reasons, the convection fan may turn on or off while the oven is cooking.
- This oven is designed for CLOSED DOOR broiling. The oven door must be closed during broiling.

CAUTION

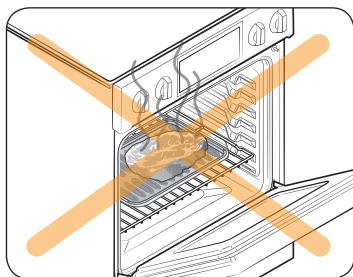

Always broil with the oven door closed. Use care when opening the door. Let hot air or steam escape before you remove food from or put food into the oven.

Using the healthy cook feature

Health Cook provides 6 different specialized cooking options.

Mode	Temperature range		Single oven	*Twin oven	
	Single oven	*Twin oven		Upper	Lower
Baked Potato	175 °F (80 °C) - 550 °F (285 °C)	175 °F (80 °C) - 480 °F (250 °C)	0	0	0
Grilled Chicken	175 °F (80 °C) - 550 °F (285 °C)	175 °F (80 °C) - 480 °F (250 °C)	0	0	0
Salmon Steak	175 °F (80 °C) - 550 °F (285 °C)	175 °F (80 °C) - 480 °F (250 °C)	0	0	0
White Fish Fillet	175 °F (80 °C) - 550 °F (285 °C)	175 °F (80 °C) - 480 °F (250 °C)	0	0	0
Dehydrate	100 °F (40 °C) - 225 °F (105 °C)	-	0	-	-
Bread Proof	** None	-	0	-	-

* To use the twin flex oven functionality, you must insert the divider into the oven and divide it into an upper and lower compartment. See page 41.

** None means that a factory set temperature is applied for the best performance. You cannot adjust this temperature.

Mode	Instruction
Baked Potato	<ul style="list-style-type: none"> • Baked Potato is specially designed to cook potatoes or sweet potatoes.
Grilled Chicken	<ul style="list-style-type: none"> • Grilled Chicken is specially designed to cook chicken pieces or chicken breasts. To prevent over-browning and drying of the skin, wrap each piece or breast of the chicken in foil.
Salmon Steak	<ul style="list-style-type: none"> • Salmon Steak is specially designed to cook salmon steaks.
White Fish Fillet	<ul style="list-style-type: none"> • White Fish Fillet is specially designed to cook white fish fillets.

Mode	Instruction									
Dehydrate	<ul style="list-style-type: none"> Dehydrate dries food or removes moisture from food via heat circulation. After drying the food, keep it in a cool and dry place. For fruit, adding lemon or pineapple juice or sprinkling sugar on the fruit helps the fruit retain sweetness. See the table below for Dehydrate settings. <table border="1"> <thead> <tr> <th>Category</th> <th>Rack position</th> <th>Temperature (°F)</th> </tr> </thead> <tbody> <tr> <td>Vegetables or Fruit</td> <td>3 or 4</td> <td>100-150</td> </tr> <tr> <td>Meat</td> <td>3 or 4</td> <td>145-225</td> </tr> </tbody> </table>	Category	Rack position	Temperature (°F)	Vegetables or Fruit	3 or 4	100-150	Meat	3 or 4	145-225
Category	Rack position	Temperature (°F)								
Vegetables or Fruit	3 or 4	100-150								
Meat	3 or 4	145-225								
Bread Proof	<ul style="list-style-type: none"> Bread Proof provides an optimal temperature for the bread proofing process, and therefore does not require a temperature adjustment. For the best results, always start the Bread Proof option with a cool oven. 									

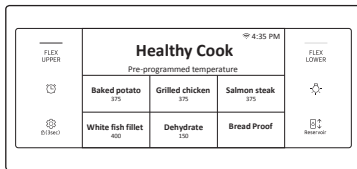

1. Turn the Mode knob to the Healthy Cook mode. The display will show the specialized cooking options.

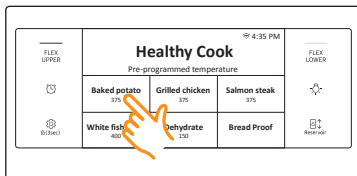

2. Tap the cooking option you want.

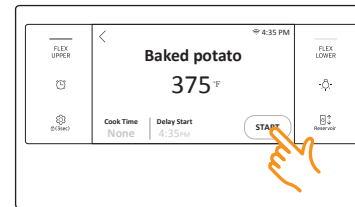

- Set the temperature you want.
- Tap **START**.

NOTE

You cannot adjust the temperature of the Bread Proof mode.

CAUTION

- Do not use Bread Proof when the oven temperature is above 125 °F. If temperature is above 125 °F, this mode won't function properly. Wait until the oven cools down.
- Do not use Bread Proof for warming food. The proofing temperature is not hot enough to keep food warm.
- Place the dough in a heat-safe container on rack position 3 or 4 and cover it with a cloth or with plastic wrap. You may need to anchor the plastic wrap underneath the container so that the oven does not blow the plastic wrap off the dough.
- To avoid lowering the temperature and extending proofing time, do not open the oven door.

NOTE

- Preheating is not necessary.
- An error beep sounds if the temperature setting is out of the set range.

Rack position chart for special cooking options

Food	Single	Flex Upper	Flex Lower
Baked Potato	5	A	1
Grilled Chicken	4 or 5	A	1
Salmon Steak	4 or 5	A	1
White Fish Fillet	4 or 5	A	1
Dehydrate	3 or 4	-	-
Bread Proof	3	-	-



Operating the oven

Using the gourmet cook feature

For inexperienced cooks, the oven offers 10 gourmet auto cook features. Take advantage of this feature to save time or shorten your learning curve. The cooking time and temperature will be adjusted according to the selected recipe. You can download detailed recipes for each feature from the Samsung website.

Operating the oven

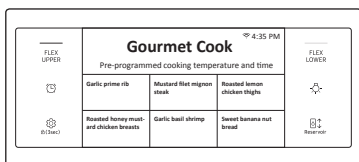

1. Turn the Mode knob to the **Gourmet Cook** mode. The display will show 10 auto cook features. (You can scroll down through the list.)

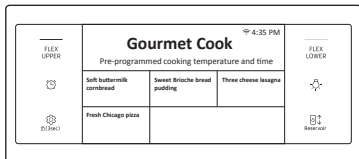

2. Tap the **Gourmet Cook** feature you want.

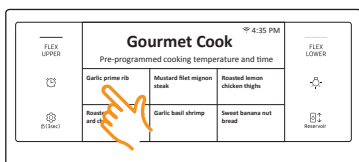

3. Follow the on-screen instructions.

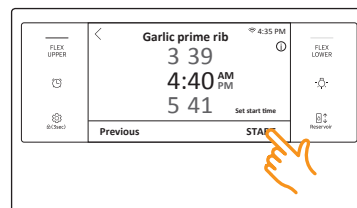
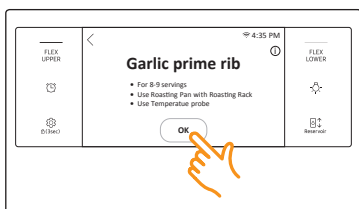

4. Tap **START** to start cooking.

Cooking tips in the gourmet cook mode

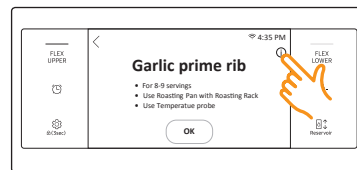

1. Tap **i** on the screen to see a cooking tip.

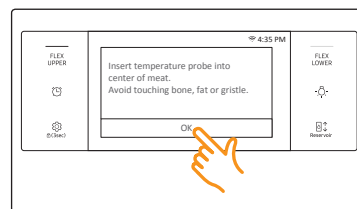

2. The display will show the cooking tip. You can see the cooking tip before you start cooking or while you are cooking.



Using the smart control feature

To use the oven's Smart Control feature, you must download Samsung's Smart Home app to a mobile device. Functions that can be operated using Samsung's Smart Home app may not work smoothly if communication conditions are poor or the oven is installed in a place with a weak Wi-Fi signal.

Please refer to the following table for the main functions that can be operated from the app.

When Smart Control on the oven is off	Monitoring (Oven, Probe), Oven off
When Smart Control on the oven is on.	Monitoring (Oven, Probe), Oven start, Oven off, Error check

How to connect the oven

1. Download and open the Samsung Smart Home app on your smart device.
2. Follow the app's on-screen instructions to connect your oven.
3. Once the process is complete, the connected  icon located on your oven displays and the app will confirm you are connected.
4. If the connection icon does not turn on, follow the instruction in the app to reconnect.

To start the oven remotely

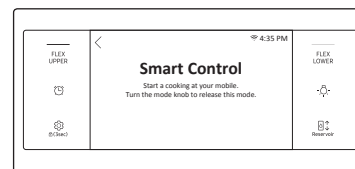

1. Turn the Mode knob to Smart Control. The oven can now be started and controlled remotely by a connected mobile device.

When Smart Control is on you can:

- Remotely change oven settings (mode, time, temperature) using your mobile device.
- Remotely start the oven.
- Remotely turn off the oven.
- Once cooking starts, you can change the cooking time and temperature remotely.

NOTE

Important: Self Clean mode cannot be started remotely.

NOTE

- Opening the oven door or turning the mode knob to other modes will deactivate Smart Control and prevent you from turning the oven on or controlling the oven remotely.
- If Smart Control is deactivated, you can still monitor the oven's status and turn the oven off.
- When oven cooking is finished or cancelled, Smart Control will be deactivated.

Operating the oven

Using the oven racks

Upper and lower oven rack positions (single mode)

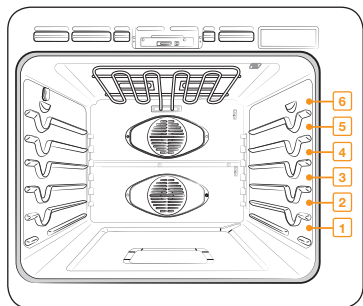

Recommended rack positions for cooking

TYPE OF FOOD	RACK POSITION
Broiling hamburgers	6
Broiling meats or small cuts of poultry, fish	4-6
Bundt cakes, pound cakes, frozen pies, casseroles	4 or 3
Angel food cakes, small roasts	2
Turkeys, large roasts, hams, fresh pizza	1

- This table is for reference only.

Upper oven rack positions with divider (twin mode)

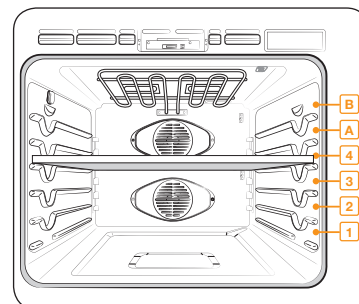

The upper compartment has 2 rack positions (A, B).

The lower compartment has 3 rack positions (1-3).

TYPE OF FOOD	RACK POSITION	
	Upper	Lower
Frozen pies	A	1
Angel food cakes	-	1
Bundt or pound cakes	-	1
Muffins, brownies, cookies, cupcakes, layer cakes, Pies, Biscuits	A	1
Casseroles	A	1
Small roast, hams	A	1
Small turkeys, medium roasts	-	1

- This table is for reference only.

Rack and Pan placement

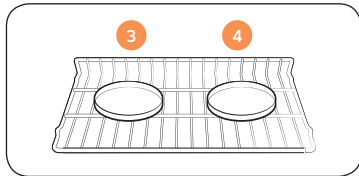

Single Oven Rack

Centering baking pans in the oven as much as possible will produce better results. If baking with more than one pan, place the pans so each has at least 1" to 1½" of air space around it.

When baking on a single oven rack, place the oven rack in **position 3 or 4**. See the figure on the left.

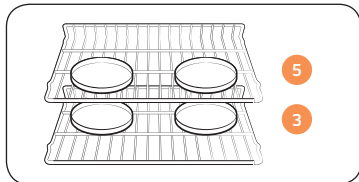

Multiple Oven Racks

When baking cakes and cookies on multiple racks, place the oven racks in **positions 3 and 5**.

Using multiple oven racks

Type of Baking	Rack Positions
Cakes and cookies	3 and 5

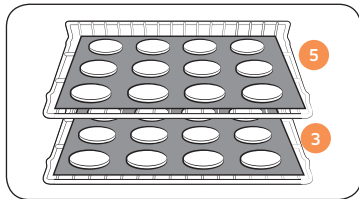

Multiple Oven Racks

Before using the racks

Each rack has stops that need to be placed correctly on the supports. These stops will keep the rack from coming completely out.

Removing the racks

1. Pull the rack straight out until it stops.
2. Lift up the front of the rack, and then pull it out.

Replacing the racks

1. Place the end of the rack on the support.
2. Tilt the front end up and push the rack in.

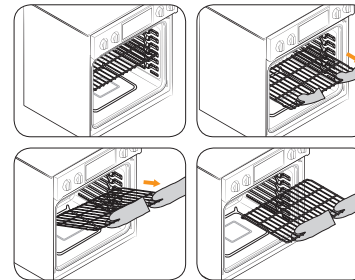

CAUTION

- Do not cover a rack with aluminum foil or place aluminum foil on the oven bottom. This will hamper heat circulation, resulting in poor baking, and may damage the oven bottom.
- Arrange the oven racks only when the oven is cool.

Operating the oven

Using the gliding rack

The fully extendable Gliding rack makes food preparation easier, especially when you are preparing heavier dishes. The Gliding rack has 2 glide tracks that allow you to extend the rack well out of the oven without touching the sides of the oven walls.

Installing the Gliding rack

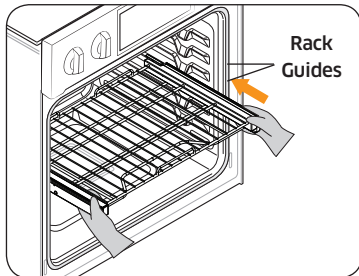

- With the Gliding rack in the Closed position and the oven off, carefully insert the Gliding Rack between the guides until the rack reaches the back.

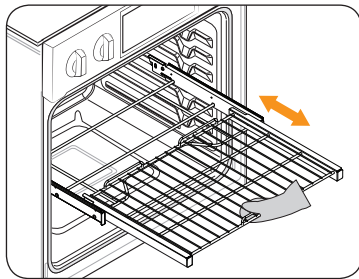

- When using the Gliding rack in the oven, be sure to pull on the handle of the rack only to slide it in and out. If you grasp the frame while using the rack, the entire Gliding rack will be removed. Make sure you use oven mitts when handling the Gliding rack during cooking.

Removing the Gliding rack

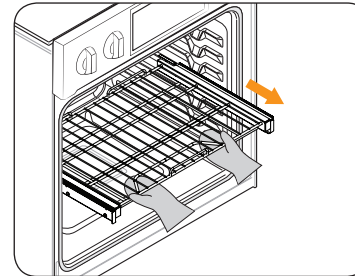

- With the Gliding rack in the Closed position and the oven off and cool, grasp the rack and frame and pull both forward to remove.

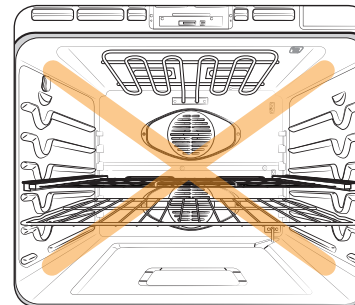

CAUTION

Do not install the Gliding rack directly above the Wire rack. You will not be able to install it properly and the rack could fall.

NOTE

You can install the Gliding rack in any rack positions except the lowest rack position in the oven (level 1).

Using the divider

- To use twin mode operation, insert the divider.
- Handle the divider with both hands.
- Use oven gloves when inserting or removing the divider.

To Install the Divider into the Oven Cavity

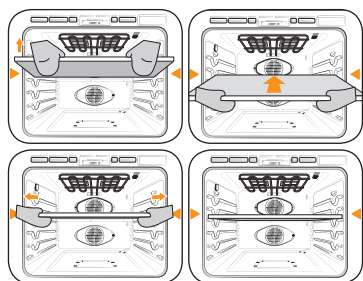

1. Insert the divider into the 4th rack position of the cavity.
2. Push the divider in until its back end rests against the back of the cavity.

⚠ CAUTION

If the oven displays -dC-

- Check the divider to see if it is installed correctly.

Using the clean feature

The Clean feature has four selections: Self-Clean, Hybrid Clean, Descale, and Draining.

Self Clean

This self-cleaning oven uses high temperatures (well above cooking temperatures) to burn off leftover grease and residue completely or reduce them to a finely powdered ash that you can wipe away with a damp cloth.

⚠ CAUTION

- During the self-cleaning cycle, the outside of the oven will become very hot to the touch. **Do not** leave small children unattended near the appliance.
- Some birds are extremely sensitive to the fumes given off during the self-cleaning cycle of any oven. Move birds to another well-ventilated room.
- **Do not** line the oven walls, racks, bottom, or any other part of the oven with aluminum foil. Doing so will result in poor heat distribution, poor baking results, and cause permanent damage to the oven interior. Aluminum foil will melt and adhere to the interior surface of the oven.
- The oven door locks during self-cleaning. **Do not** force the oven door open. This can damage the automatic door locking system. Use care when opening the oven door after the self-cleaning cycle is complete. Stand to the side of the oven when opening the door to allow hot air or steam to escape. The oven may still be **VERY HOT**.

Operating the oven

Before a self cleaning cycle

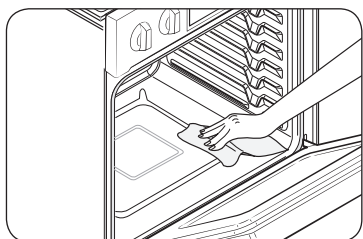

Fig. 1

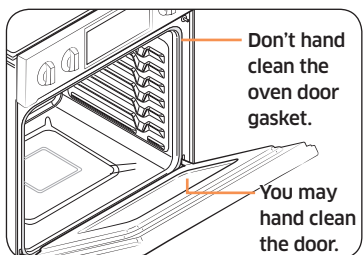
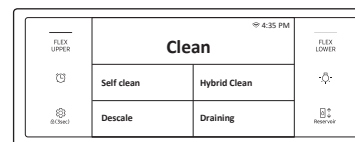

Fig. 2

- We recommend venting your kitchen with an open window or using a ventilation fan or hood during the self-cleaning cycle.
- Remove the wire rack, broil pan, broil pan insert, all cookware, and any aluminum foil from the oven.
- Wipe up debris from the oven bottom.
- (Fig. 1)
- The silver-colored oven racks can be self-cleaned, but they will darken, lose their luster, and become hard to slide.
- Residue on the front frame of the oven and outside the gasket on the door will need to be cleaned by hand. Clean these areas with hot water, soap-filled steel-wool pads, or cleansers such as Soft Scrub. Rinse well with clean water and dry.
- Do not clean the gasket. The fiberglass material of the oven door gasket cannot withstand abrasion. It is essential for the gasket to remain intact. If you notice it becoming worn or frayed, have it replaced. (Fig. 2)
- Make sure the oven light cover is in place and the oven light is off.

How to run a self cleaning cycle



1. Turn the Mode knob to **Clean**. The display will show 4 cleaning selections.

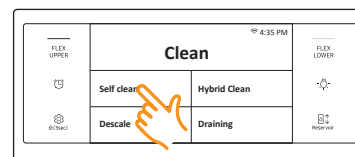

2. Tap **Self Clean**.

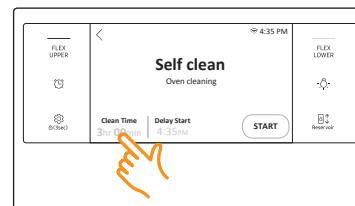

3. Tap **Clean Time**.

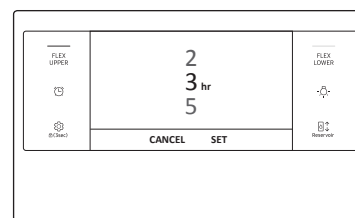

4. Flick the screen to set the clean time. You can choose 2 hours, 3 hours, or 5 hours. (The default is 3h).
5. Tap **SET**.

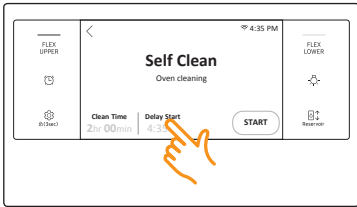

6. If you don't want to use the Delay Start feature, go to Step 8. Otherwise, tap **Delay Start**, and then go to Step 7.

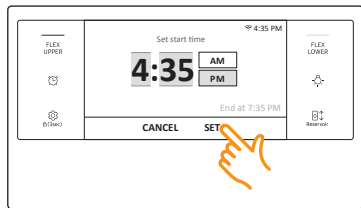

7. Set the time you want self-cleaning to start, and then tap **Set**.

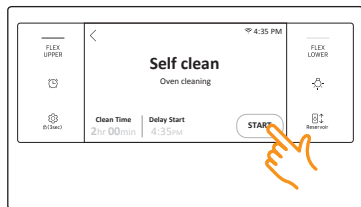

8. Tap **START** to begin self-cleaning. The motor-driven door lock will engage automatically.

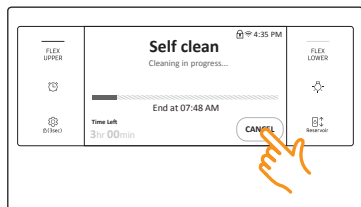

9. If you need to stop or interrupt a self cleaning cycle, tap **CANCEL**.

NOTE

- You will not be able to start a self-cleaning cycle if the control lockout feature is activated or if the oven's temperature is too hot.
- The oven door locks automatically. The display will show the cleaning time remaining. You cannot open the oven door until the temperature drops to a safe/cool temperature.

After a self-cleaning cycle

- You may notice some white ash in the oven. Wipe it up with a damp cloth after the oven cools. (If white spots remain, remove them with a soap-filled steel wool pad and rinse thoroughly with a vinegar and water mixture.)
- If the oven is not clean after one cycle, repeat the cycle.
- You cannot set the oven for cooking until the oven is cool enough for the door to unlock.

Hybrid Clean

The Hybrid cleaning function saves time and energy by removing leftover grease and residue that you can wipe away with a damp cloth.

CAUTION

- Do not** line the oven walls, racks, bottom, or any other part of the oven with aluminum foil. Doing so will result in poor heat distribution, poor baking results, and cause permanent damage to the oven interior. Aluminum foil will melt and adhere to the interior surface of the oven.
- The oven door locks during Hybrid cleaning. **Do not** force the oven door open. This can damage the automatic door locking system. Use care when opening the oven door after a Hybrid cleaning cycle is complete. Stand to the side of the oven when opening the door to allow hot air or steam to escape.

Operating the oven

Before a Hybrid cleaning cycle

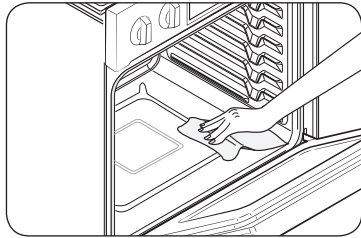

Fig. 1

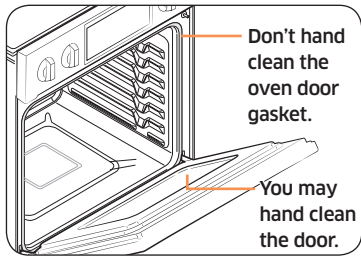

Fig. 2

- Remove the wire rack, broil pan, broil pan insert, all cookware, and any aluminum foil from the oven.
- Wipe up debris from the oven bottom. (Fig. 1)
- The silver-colored oven racks can be Hybrid cleaned, but they will darken, lose their luster, and become harder to slide.
- Residue on the front frame of the oven and outside the gasket on the door will need to be cleaned by hand. Clean these areas with hot water, soap-filled steel-wool pads, or cleansers such as Soft Scrub. Rinse well with clean water and dry.
- Do not clean the gasket. The fiberglass material of the oven door gasket cannot withstand abrasion. It is essential for the gasket to remain intact. If you notice it becoming worn or frayed, have it replaced. (Fig. 2)
- Make sure the oven light cover is in place and the oven light is off.

NOTE

Remove oven racks and accessories before starting the Hybrid Clean mode.

How to run a hybrid cleaning cycle

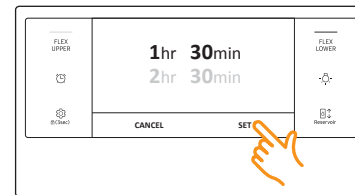
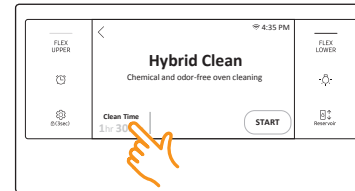
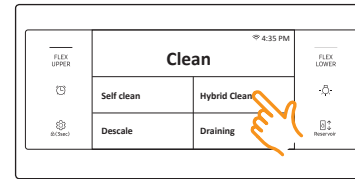
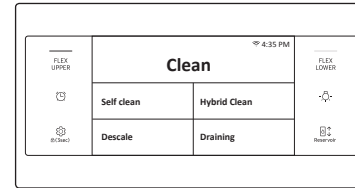

1. Turn the Mode knob to **Clean**. The display will show 4 cleaning selections.
2. Tap **Hybrid Clean**.
3. Tap the Clean Time area to adjust the clean time. The clean time adjustment screen appears. You can set the clean time to 1hr 30min or 2hr 30min.
4. Tap **SET**. The clean time adjustment screen closes and the clean time information is displayed on the screen.

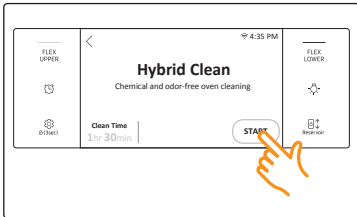

5. Tap **START** to begin Hybrid cleaning.

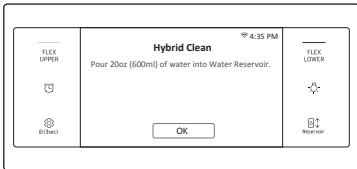

6. Follow the on-screen instructions. Hybrid cleaning will start automatically after the oven senses water in the water reservoir.

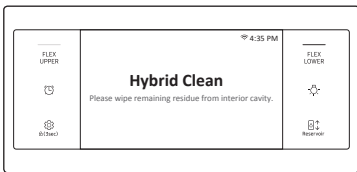

7. When Hybrid cleaning is complete, clean the oven's interior. There will be a significant amount of water remaining on the bottom of the oven after a Hybrid cleaning cycle. Remove the residual water with a sponge or soft dry cloth.

NOTE

For Hybrid cleaning, use exactly 20 oz (600 ml). of water since this produces the best results.

After a Hybrid cleaning cycle

- Take care when opening the door after a Hybrid cleaning procedure has ended. The water on the bottom is hot.
- Open the oven door and remove the remaining water with a sponge. Do not leave the residual water in the oven for any length of time. Wipe the oven clean and dry with a soft cloth. Do not forget to wipe under the oven door seal.
- Use a detergent-soaked sponge, a soft brush, or a nylon scrubber to wipe the oven interior. Remove stubborn residue with a nylon scourer. You can remove lime deposits with a cloth soaked in vinegar.
- If the oven remains dirty, you can repeat the procedure once the oven has cooled.
- For heavy residue, such as grease left over from roasting, we recommend that you rub detergent into the residue before activating the Hybrid cleaning function.
- After cleaning, leave the oven door ajar at a 15° angle to allow the interior enamel surface to dry thoroughly.

NOTE

- You will not be able to start a Hybrid cleaning cycle if the Control Lockout feature is activated or if the oven's temperature is too hot.
- The oven door locks automatically. The display will show the cleaning time remaining. You cannot open the oven door until the temperature drops to a safe/cool temperature.
- If the oven is not clean after one cycle, repeat the cycle.
- You cannot set the oven for cooking until the oven is cool enough for the door to unlock.



Operating the oven

Descal

If you use Steam Bake or Steam Roast functions frequently, we recommend descaling regularly to remove minerals from the oven that may affect the taste or quality of food cooked. When running a descaling cycle, use only descaling agents that are specific to steam ovens or coffee machines.

NOTE

If you use Steam Bake or Steam Roast functions for more than a total of 12 hours, the Descal indicator turns on. You can still enable the Steam Bake or Steam Roast functions for the next two hours without descaling. However, after those two hours are up, the Steam Bake or Steam Roast functions will be disabled until you run a descaling cycle.

How to run a descale cycle

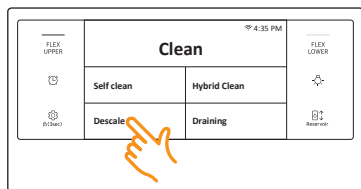

1. Turn the Mode knob to **Clean**. The display will show 4 cleaning selections.
2. Tap **Descal**.

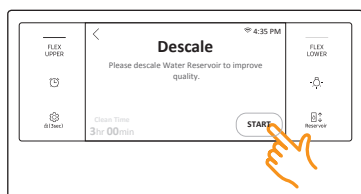

3. Tap **START**.

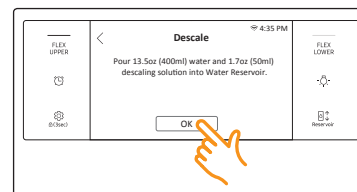

4. Follow the on-screen instructions. It takes 3 hours to complete the cycle.
 - Empty and clean the water reservoir, and then fill it with 1.7 oz (50 ml) of descaling agent and 13.5 oz (400 ml) of drinkable water.

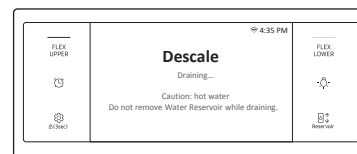

5. When descailling is complete, the oven drains water automatically.
6. Use oven gloves to remove and empty the water reservoir, and then refill it with 22 oz (650 ml) of drinkable water for rinsing.



7. Follow the on-screen instructions, and then tap **OK** to start rinsing.

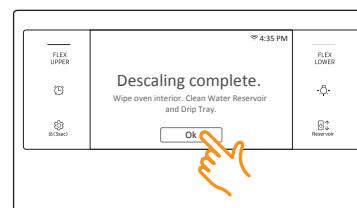

8. When rinsing is complete, use oven gloves to empty and clean the water reservoir.



⚠ WARNING

Use only descaling agents that are specific to steam ovens or coffee machines.

⚠ CAUTION

- Running the Descaling function disables Steam Bake and Steam Roast. Do not cancel descaling while it is in process. If you stop it, you must restart the descaling cycle and complete it within the next three hours to re-enable the Steam Bake and Steam Roast functions.
- To avoid accidents, keep children away from the oven.
- For the correct ratio of water and the descaling agent, follow the agent manufacturer's instructions. If the ratio of water to descaling agent differs from the instructions here (8 to 1), use the ratio indicated in the instructions for the descaling agent.

📄 NOTE

Although the oven automatically starts descaling in 5 seconds without your confirmation, we recommend that you confirm your selection. This is to prevent descaling from starting by mistake.

Draining

When a steam function is complete, you must drain the remaining water to prevent the water from affecting other cooking modes. To drain the water, follow these steps:

How to run a draining

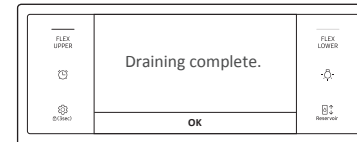
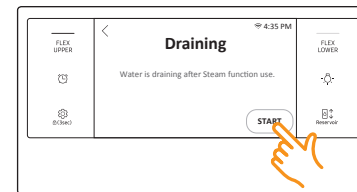
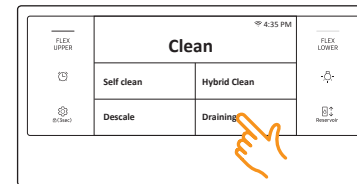

1. Turn the Mode knob to Clean. The display will show 4 cleaning selections.
2. Tap **Draining**.

3. Tap **START**. The oven drains water from the steam generator to the water reservoir.

4. When draining is complete, use oven gloves to remove and empty the water reservoir.

📄 NOTE

Once the oven starts draining, please wait until the draining cycle is complete.

Operating the oven

Settings

In Settings, you can change the default settings to your preference or diagnose problems with the network connection.

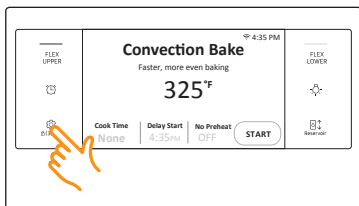

Tap **Settings**. The display will show the Setting item.

Wi-Fi

To enable a Wi-Fi connection

1. Tap **Settings** > **Wi-Fi**, and then tap **ON** in the right screen.
2. Tap Wi-Fi, and then tap a Wi-Fi network in the list that appears.
3. You will be prompted to provide a password for a secure network. Enter the password.

To manually input an IP

1. Tap **Settings** > **Wi-Fi**, and then tap **ON** in the right screen.
2. Tap **Wi-Fi**, and then tap **Add Network**.
3. Enter an IP manually, and then tap **CONNECT** to apply your settings.

NOTE

- To disable a Wi-Fi connection, Tap **Settings** > **Wi-Fi**, and then tap **OFF** in the right screen.
- For details about the Wi-Fi connection and using the Samsung Smart Home app, see the Smart Home app user manual.

Display

1. **Brightness**
You can change the brightness of the display screen.
 - Tap **Settings** > **Display** > **Brightness**, and then use the bar next to Brightness to adjust the brightness of the screen.
2. **Screen saver**
If screen saver is turned off, the Clock theme and Timeout menu are disabled.
 - Tap **Settings** > **Display** > **Screen saver**, and then tap **OFF** in the right screen.
3. **Clock theme**
 - Tap **Settings** > **Display** > **Clock theme**, and then tap in the right screen. You can select a theme.
4. **Timeout**
 - Tap **Settings** > **Display** > **Timeout**, and then tap in the right screen. You can select a time from 5 minutes to 60 minutes.

Date & Time

To enable automatic date and time

1. Turn on the Wi-Fi connection.
2. Tap **Settings** > **Date & Time**, and then tap **Date & Time**.
3. Tap **ON** in the right screen. The data and time are set automatically.

To manually input the date and time

1. Tap **Settings** > **Date & Time**, and then tap **Date & Time**.
2. Tap **OFF** in the right screen. Time zone, set date, and set time are activated.
3. You can set the time zone, date, and time.

To change the time format

1. Tap **Settings** > **Date & Time** > Select time format, and then tap in the right screen.
2. You can select 12-hour clock or 24-hour clock.

Language

Choose a display language.

1. Tap **Settings** > **Language**, and then tap in the right screen.
2. You can select English, Spanish, or French.

Volume

Adjust the volume level for beeps and melodies.

- Tap **Settings**  > **Volume**, and then use the bar next to Volume to adjust the volume.

Temp

1. Temp unit

You can program the oven control to display the temperature in Fahrenheit or Celsius. The oven has been preset at the factory to display in Fahrenheit.

- Tap **Settings**  > **Temp** > **Temp unit**, and then tap in the right screen. You can select °C or °F.

2. Temp adjust

The temperature in the oven has been calibrated at the factory. When first using the oven, be sure to follow recipe times and temperatures.

If you think the oven is too hot or too cool, you can correct the temperature in the oven. Before correcting, test a recipe by using a temperature setting that is higher or lower than the recommended temperature.

The baking results should help you to decide how much of an adjustment is needed. The oven temperature can be adjusted ± 35 °F (± 19 °C).

- Tap **Settings**  > **Temp** > **Temperature Adjust**, and then tap in the right screen. You can increase or decrease the temperature by 35 °F (19 °C).

NOTE

This adjustment will not affect the broiling or the self-cleaning temperatures. The adjustment will be retained in memory after a power failure.

12 hour energy Saving

If you accidentally leave the oven on, this feature will automatically turn off the oven after 12 hours during baking functions or after 3 hours during a broil function.

1. Tap **Settings**  > **12 hour energy Saving**, and then tap **ON** in the right screen.
2. The 12 hour energy saving icon will appear in the indicator area.

Easy connection

Easy connection enables you to easily configure the network settings including the authentication procedure.

Help

Help provides useful tips and explanations on a specific item that you select.

1. Troubleshooting

- Tap a checkpoint directly on the screen, and try the suggestions.

2. Guide for first use

- Provides simple instructions on the basic use of the oven.

About device

You can see information about the oven and do a software update.

To update the software:

1. Tap **Settings**  > **About device** > **SW update**, and then tap **Update** in the right screen.
2. Tap **INSTALL**. The software is updated and the system restarts automatically.

Sabbath

You can set Sabbath mode. See the **Using the Sabbath feature** section on the next page.

Demo mode

This option is for use by retail establishments for display purposes only. (The heating element does not operate.)

1. Tap **Settings**  > **Demo mode**, and then tap **ON** in the right screen.
2. The Demo mode indicator appears on screen.

Operating the oven

Using the Sabbath feature

(For use on the Jewish Sabbath & Holidays)



For further assistance, guidelines for proper usage, and a complete list of models with the Sabbath feature, please visit the web at <http://www.star-k.org>.

You can use the Sabbath feature with baking only. The oven temperature may be set higher or lower after you set the Sabbath feature. (The oven temperature adjustment feature should be used only during Jewish holidays.) The display, however, will not change and tones will not sound when a change occurs. Once the oven is properly set for baking with the Sabbath feature active, the oven will remain on continuously until the Sabbath feature is cancelled. This will override the factory preset 12 hour energy saving feature. If the oven light is needed during the Sabbath, touch **Lamp** before activating the Sabbath feature. Once the oven light is turned on and the Sabbath feature is active, the oven light will remain on until the Sabbath feature is turned off. If the oven light needs to be off, be sure to turn the oven light off before activating the Sabbath feature.

How to use the Sabbath feature

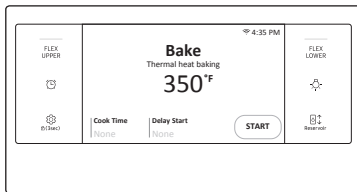

1. Turn the Mode knob to Bake mode.

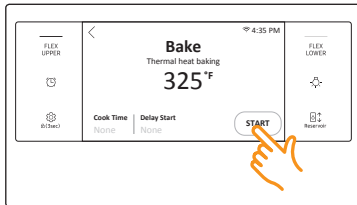



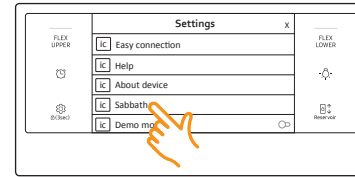

2. Set the temperature and cook time you want.
3. Tap **START**.

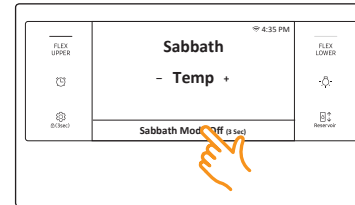

4. Tap **Settings** > **Sabbath**, and then tap **Sabbath** to use the Sabbath feature. The oven will not beep or display any further changes. You may change the oven temperature once baking has started. Remember that the oven will not beep or display any further changes once the Sabbath feature is engaged.



5. You can turn the oven off at any time by touching and holding **Sabbath Off** for 3 seconds or turning the Mode knob to the **OFF** position. Note that this does not turn Sabbath mode off.
6. To turn Sabbath mode off, touch and hold **Sabbath Off** for 3 seconds.

-  Do not attempt to activate any other program feature except Bake while the Sabbath feature is active.
-  You can change the oven temperature, but the display will not change and tones will not sound when a change occurs. (The oven temperature adjustment feature should be used only on Jewish holidays.) After you change the temperature while the unit is in Sabbath mode, there is a 15 second delay before the unit recognizes the change.
-  You can set the Cook Time function before activating the Sabbath feature.
-  Should you experience a power failure or interruption, the oven will shut off. When power is returned, the oven will not turn back on automatically. **Sabbath** will be displayed in the oven control display, but the oven will not operate. Food may be safely removed from the oven while it is still in the Sabbath mode, however the oven cannot be turned back on until after the Sabbath Holidays. After the Sabbath observance, turn off the Sabbath mode. Touch and hold **Sabbath Off** for 3 seconds.
-  Do not open the oven door or change the oven temperature for about 30 minutes after you have started Sabbath mode to allow the oven to reach the set temperature. Note that for best performance, the oven fan operates only when the oven temperature is rising.

Maintaining your appliance

Care and cleaning of the oven

Cleaning painted parts and decorative trim

- For general cleaning, use a cloth with hot, soapy water.
- For more difficult residue and built-up grease, apply a liquid detergent directly onto the area and leave for 30 to 60 minutes. Wipe with a damp cloth and dry. Do not use abrasive cleaners on any oven surface. They can be scratched.

Cleaning stainless steel surfaces

1. Shake a bottle of Stainless Steel Appliance Cleaner or Polish well.
2. Place a small amount of stainless steel appliance cleaner or polish on a damp cloth or damp paper towel.
3. Clean a small area, rubbing with the grain of the stainless steel if applicable.
4. Dry and buff with a clean, dry paper towel or soft cloth.
5. Repeat as necessary.

NOTE

- **Do not use a steel-wool pad. It will scratch the surface.**
- If a mineral oil-based stainless steel appliance cleaner has been used before to clean the appliance, wash the surface with dishwashing liquid and water prior to using the Stainless Steel Appliance Cleaner or Polish.

Maintaining your appliance

Oven racks

- If the racks are left in the oven during a self-cleaning cycle, their color will turn slightly blue and the finish will be dull. After the self-cleaning cycle is complete and the oven has cooled, rub the sides of the racks with wax paper or a cloth containing a small amount of oil. This will help the racks glide more easily on their tracks.
- Gliding racks may be cleaned by hand with an abrasive cleaner or steel wool. During cleaning, be careful not to allow water or cleaner to enter the slides on the sides of rack.

NOTE

- Do not clean in a dishwasher.
- If the rack becomes hard to remove or replace, lightly wipe the oven rack guides with cooking oil. Do not wipe cooking oil on the slides.
- If the rack becomes difficult to slide, the rack may need to be lubricated using a graphite lubricant.

NOTE

- To order graphite lubricant, call Samsung customer care at 1-800-SAMSUNG (726-7864) or visit our homepage (www.samsung.com/us/support, www.samsung.com/ca/support, or www.samsung.com/ca_fr/support) and search for part number DG81-01629A.
- If you want to buy directly, go to <http://www.samsungparts.com>.

To lubricate the slides of the gliding rack

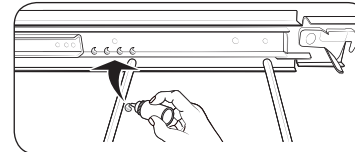
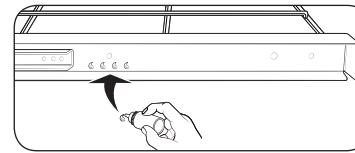
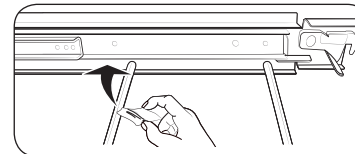
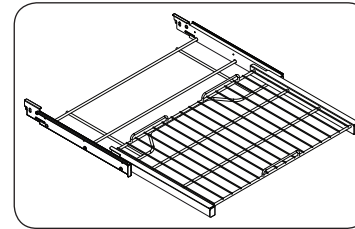

1. Remove the rack from the oven. See removing the gliding rack in the **Using the gliding rack** section on page 40.
2. Fully extend the rack on a table or countertop. Newspaper may be placed underneath the rack for easy cleanup.
3. If there is debris in the slide tracks, wipe it away using a paper towel. (Any graphite lubricant wiped away must be replaced - See steps 4 through 7.
4. Shake the graphite lubricant before opening it. Starting with the left (front and back) slide mechanism of the rack, place four (4) small drops of lubricant on the two (2) bottom tracks of the slide close to the bearing carriers.

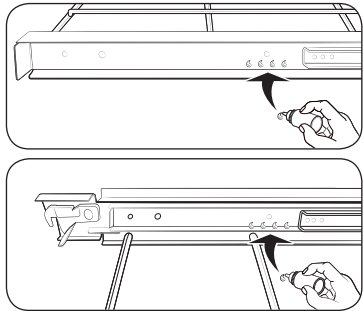

5. Repeat for the right (front and back) slide mechanism of the rack.
6. Open and close the rack several times to distribute the lubricant.
7. Replace the cap on the lubricant and shake it again. Turn the rack over and repeat steps 3, 4, 5, and 6.
8. Close the rack, turn the rack right-side-up, and then place in oven. See **Installing the Gliding rack** on page 40.

NOTE

- Do not spray the gliding rack with cooking spray or other lubricant sprays.

Oven door

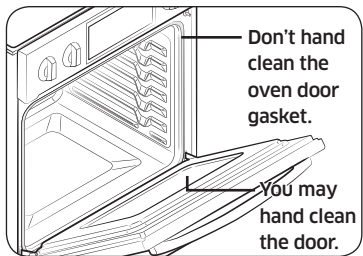

- Use soap and water to thoroughly clean the top, sides, and front of the oven door. Rinse well. You may use a glass cleaner on the outside glass of the oven door. **DO NOT immerse the door in water. DO NOT spray or allow water or the glass cleaner to enter the door vents.** DO NOT use oven cleaners, cleaning powders, or any harsh abrasive cleaning materials on the outside of the oven door.
- **DO NOT clean the oven door gasket.** The oven door gasket is made of a woven material which is essential for a good seal. Care should be taken not to rub, damage, or remove this gasket.

Removing the oven doors

CAUTION

- The door is very heavy. Be careful when removing and lifting the door.
- Do not lift the door by the handle. Use two hands to remove an oven door. For double ovens, repeat the process for each door.

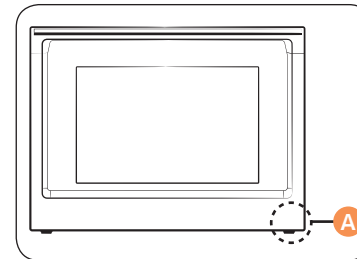

A. Wire Harness

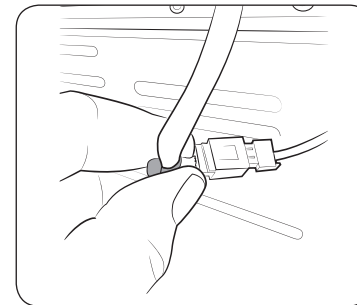

1. Prior to removing the oven door, prepare a surface where you will place it. This surface should be flat and covered with a soft blanket. You can also use the corner posts from your packaging material.
2. Disconnect the LED light's Wire Harness from the bottom right of the door.

Maintaining your appliance

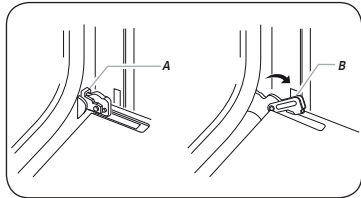

- A. Oven door hinge lock in locked position
- B. Oven door hinge lock in unlocked position

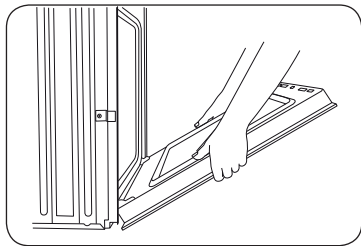

3. Open the oven door.
4. Locate the oven door hinge locks in both corners of the oven door, and then rotate the hinge locks toward the oven door to the unlocked position. If the door hinge lock is not rotated fully (see illustration B on the left for an example of full rotation), you will not be able to remove the door properly.
5. Partially close the door to engage the door latch locks. The door will stop at this point.

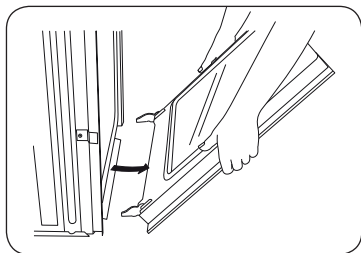

6. Using two hands, grasp the edges of the oven door. Lift and pull the oven door toward you and remove. You may need to gently shift the door from side to side as you pull.
7. Set the oven door aside on the prepared covered work surface with the oven door resting on its handle.

Maintaining your appliance

Replacing the oven doors

⚠ CAUTION

The door is very heavy. You may need help lifting the door high enough to slide it into the hinge slots. Do not lift the door by the handle.

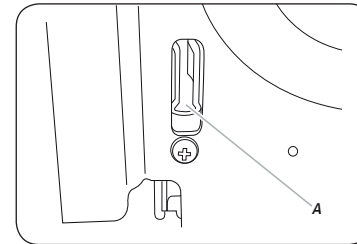

- A. Slot in the oven cavity for the door hinge lock

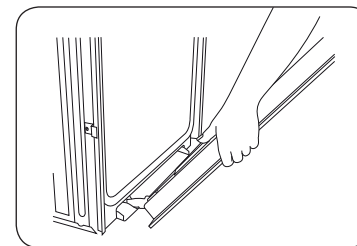

1. Using two hands, grasp the side edges of the door at the midpoint. Face the oven cavity.
2. Locate the slots on each side of the oven cavity for the door hinge locks.
3. Hold the door at a 45° angle, and then align the door hinges with the slots in the lower front of the oven cavity. Slowly insert the door, making sure you maintain the 45° angle. You will know the door is engaged in the slot when you feel a slight drop.

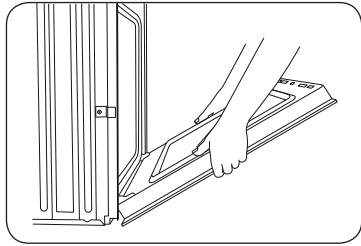

4. Lower the oven door to the fully open position. If the oven door does not open to a full 90°, repeat steps 1 through 3.
5. Locate the oven door hinge locks in the corners of the oven door, and rotate the hinge locks toward the oven cavity to the locked position. See Step 3 (illustration A) in the "Removing the oven doors" section for the proper locked position.
6. Close the oven door.
7. When the hinges are properly installed and the door is closed, there should be an even gap between the door and the control panel. If one side of the oven door is hanging lower than the other, the hinge on that side is not properly installed.
8. Reconnect the LED light's Wire Harness.

CAUTION

After replacing the door, make sure to reconnect the wires. Push them inward to arrange them as they were before you removed the door. Wires that are not connected or arranged correctly can be caught in the door or damaged by heat.

Changing the oven light

The oven light is a standard 40-watt appliance halogen bulb. It comes on when the oven door is open. When the oven door is closed, touch **Lamp**  to turn the light on or off. It will not work during a self-cleaning or Hybrid cleaning cycle.

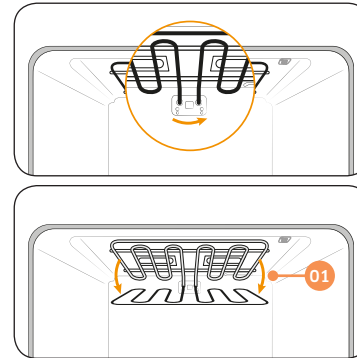

1. To change the halogen bulb, you must tilt the broil heater down. To do this, turn the circular nut on the support counterclockwise while holding the broil heater. The broil heater should loosen and tilt down.
- Important:** The broil heater is not a removable part. Do not force the broil heater down. Do not let it drop down.
2. Remove the glass cover.
 3. Remove the halogen bulb cover.
 4. Replace the halogen bulb.
 5. When done, replace the glass cover, and then follow Step 1 above in the reverse order to return the broiler to its correct position.

CAUTION

Before changing your oven light, disconnect the electrical power to the oven at the main fuse or circuit breaker panel. Make sure the oven and the halogen bulb are cool.

Troubleshooting

Troubleshooting

Samsung works hard to ensure that you don't have problems with your new electric oven. If you run into unexpected trouble, look first for a solution in the tables below. If you're still having trouble after trying the suggested solution, call Samsung at 1-800-SAMSUNG (1-800-726-7864).

CONTROL DISPLAY

Problem	Possible cause	Solution
The display goes blank.	A fuse in your home may be blown or the circuit breaker tripped.	Replace the fuse or reset the circuit breaker.
The buttons cannot be pressed properly.	<ul style="list-style-type: none"> There is foreign matter caught between the buttons Touch model: There is moisture on the exterior The lock function is set 	<ul style="list-style-type: none"> Remove the foreign matter and try again. Remove the moisture and try again. Check whether the lock function is set.

OVEN

Problem	Possible cause	Solution
The oven will not turn on.	The oven is not completely plugged into the electrical outlet.	Make sure the electrical plug is inserted into a live, properly grounded outlet.
	A fuse in your home may be blown or a circuit breaker may have tripped.	Replace the fuse or reset the circuit breaker.
	The oven controls have been set improperly.	See the Operating the oven section starting on page 20.
	The oven is too hot.	Allow the oven to cool.
	Incomplete service wiring.	Call for service.
	Power outage.	Check to see if the house lights will turn on. If necessary, call your local electric company for service.
The oven light will not turn on.	The light is loose or defective.	<ul style="list-style-type: none"> Tighten or replace the lamp. Call for service if the door light does not turn on.
	The switch operating the light is broken.	Call for service.

Problem	Possible cause	Solution
The oven smokes excessively during broiling.	The oven controls have not been set properly.	See the Operating the oven section starting on page 20.
	The meat has been placed too close to the element.	Reposition the rack to provide proper clearance between the meat and the element. Preheat the broil element for searing.
	The meat has not been properly prepared.	Remove excess fat from the meat. Cut away fatty edges that may curl, leaving the lean intact.
	Grease has built up on oven surfaces.	Regular cleaning is necessary when broiling frequently.
Food does not bake or roast properly.	The oven controls have not been set correctly.	See the Operating the oven section starting on page 20.
	The oven rack has been positioned incorrectly or is not level.	See the Using the oven racks section on page 38.
	The oven thermistor needs to be adjusted.	See Temp adjust in the Settings section on page 49.

Problem	Possible cause	Solution
Food does not broil properly.	The serving size may not be appropriate.	Refer to the Broiling recommendation guide for serving sizes on page 30, and then try again.
	The rack has not been properly positioned.	See the Broiling recommendation guide on page 30.
	The cookware is not suited for broiling.	Use suitable cookware.
	In some areas, the power (voltage) may be low.	<ul style="list-style-type: none"> Preheat the broil element for 10 minutes. See the broiling recommendation guide on page 29.
The oven temperature is too hot or too cold.	The oven thermistor needs to be adjusted.	See Temp adjust in the Settings section on page 49.
There is water dripping.	You may see water or steam in some cases depending on the food you are cooking. This is not a product malfunction.	Let the oven cool and then wipe with a dry dish towel.
There is steam coming through the crack between the oven body and the door.		
Water remains in the oven.		

Troubleshooting

Problem	Possible cause	Solution
I can hear water boiling during steam cooking.	Water is being heated by the steam heater.	This is not a product malfunction.
The oven will not self-clean.	The oven temperature is too high to start a self-clean operation.	Allow the oven to cool and then reset the controls.
	The oven controls have been set incorrectly.	See the Self Clean section on page 41.
	A self-cleaning cycle cannot be started if the oven lockout feature has been activated.	Deactivate the oven lockout (see page 22).
Excessive smoking during a self-cleaning cycle.	There is excessive soiling in the oven.	Press OFF . Open the windows to rid the room of smoke. Wait until the self-cleaning cycle is cancelled. Wipe up the excessive soil and then start the self-cleaning cycle again.
The oven door will not open after a self-cleaning cycle.	The oven is too hot.	Allow the oven to cool.
The oven is not clean after a self-cleaning cycle.	The oven controls were not set correctly.	See the Self Clean section on page 41.
	The oven was heavily soiled.	Wipe up heavy spillovers before starting the self-cleaning cycle. Heavily soiled ovens may need to be self-cleaned again or for a longer period of time.

Problem	Possible cause	Solution
Steam is coming out of the vent.	When using the convection feature, it is normal to see steam coming out of the oven vent.	This is normal operation and not a system failure. Use the oven as usual.
	As the number of racks or amount of food being cooked increases, the amount of visible steam will increase.	
A burning or oily odor is coming from the vent.	This is normal for a new oven and will disappear in time.	<ul style="list-style-type: none"> To speed the process, set a self-cleaning cycle for a minimum of 3 hours. See the Self Clean section on page 41.
Strong odor.	An odor coming from the insulation around the inside of the oven is normal for the first few times the oven is used.	Operate the oven empty on the bake setting at 400 °F for 1 hour.
Fan noise.	A convection fan may automatically turn on and off.	This is not a system failure but normal operation.
The oven racks are difficult to slide.	The shiny, silver-colored racks were cleaned in a self-cleaning cycle.	Apply a small amount of vegetable oil to a paper towel, and then wipe the edges of the oven racks with the paper towel.
The oven door is locked.	The circuit breaker has been tripped or there was a power failure while the oven door was locked.	Activate Control Lockout, and then unlock the control. See the Control Lockout section on page 22.

Information codes

OVEN

Displayed Code	Possible cause	Solution
C-d0	This code occurs if the control key is short for 1 minute.	Clean the buttons and make sure there is no water on/ around them. Turn off the oven and try again. If the problem continues, contact a local Samsung service center.
C-d1	This code occurs if the door lock is mispositioned.	Press OFF , and then restart the oven. If the problem persists, disconnect all power to the oven for at least 30 seconds and then reconnect the power. If this does not solve the problem, call for service.
C-F0	This code occurs if communication between the Main and Sub PBA is interrupted.	
C-F2	This code occurs if communication between the Main and Touch is interrupted.	
C-20	The oven sensor is open when the oven is operating.	
	The oven sensor is short when the oven is operating.	
C-21	This code occurs if the internal temperature rises abnormally high.	

Displayed Code	Possible cause	Solution
C-23	The temp probe sensor is short when the oven is operating.	Press OFF , and then restart the oven. If the problem persists, disconnect all power to the oven for at least 30 seconds and then reconnect the power. If this does not solve the problem, call for service.
C-30	The PCB sensor is open when the oven is operating.	
		The PCB sensor is short when the oven is operating.
C-31	This code occurs if the PCB temperature rises abnormally high.	Call for service
-dC-	This code appears if the divider is inserted or removed while the oven is operating.	Make sure the divider is inserted properly, and then restart the oven. If the problem persists, disconnect all power to the oven for at least 30 seconds and then reconnect the power. If this does not solve the problem, call for service.
C-70	The steam sensor is open when the oven is operating	Press OFF, and then restart the oven. If the problem persists, disconnect all power to the oven for at least 30 seconds and then reconnect the power. If does not solve the problem, call the service.
	The steam sensor is short when the oven is operating	
C-72	There are drain system-related problems.	
C-A2	The cooling motor is operating abnormally.	Call for service.

Warranty (U.S.A)

PLEASE DO NOT DISCARD. THIS PAGE REPLACES THE WARRANTY PAGE IN THE USE & CARE GUIDE

SAMSUNG ELECTRIC OVEN

LIMITED WARRANTY TO ORIGINAL PURCHASER

This SAMSUNG brand product, as supplied and distributed by SAMSUNG ELECTRONICS AMERICA, INC. (SAMSUNG) and delivered new, in the original carton to the original consumer purchaser, is warranted by SAMSUNG against manufacturing defects in materials and workmanship for a limited warranty period of:

One (1) Year Parts and Labor

This limited warranty begins on the original date of purchase, and is valid only on products purchased and used in the United States. To receive warranty service, the purchaser must contact SAMSUNG for problem determination and service procedures. Warranty service can only be performed by a SAMSUNG authorized service center. The original dated bill of sale must be presented upon request as proof of purchase to SAMSUNG or SAMSUNG's authorized service center. Samsung will provide in-home service during the warranty period at no charge subject to availability within the contiguous United States. In home service is not available in all areas. To receive in home service, the product must be unobstructed and accessible to the service agent. If service is not available Samsung may elect to provide transportation of the product to and from an authorized service center. SAMSUNG will repair or replace this product, at our option and at no charge as stipulated herein, with new or reconditioned parts or products if found to be defective during the limited warranty period specified above. All replaced parts and products become the property of SAMSUNG and must be returned to SAMSUNG. Replacement parts and products assume the remaining original warranty, or ninety (90) days, whichever is longer.

This limited warranty covers manufacturing defects in materials and workmanship encountered in normal, noncommercial use of this product and shall not apply to the following: damage which occurs in shipment; delivery and installation; applications and uses for which this product was not intended; altered product or serial numbers; cosmetic damage or exterior finish; accidents, abuse, neglect, fire, water, lightning or other acts of nature; use of products, equipment, systems, utilities, services, parts, supplies, accessories, applications, installations, repairs, external wiring or connectors not supplied or authorized by SAMSUNG which damage this product or result in service problems; incorrect electrical line voltage, fluctuations and surges; customer adjustments and failure to follow operating instructions, maintenance and environmental instructions that are covered and prescribed in the instruction book; product removal and reinstallation; problems caused by pest infestations, and overheating or overcooking by user. This limited warranty shall not cover cases of incorrect electric current, voltage or supply, light bulbs, house fuses, house wiring, cost of a service call for instructions, or fixing installation errors. SAMSUNG does not warrant uninterrupted or error-free operation of the product.

EXCEPT AS SET FORTH HEREIN THERE ARE NO WARRANTIES ON THIS PRODUCT EITHER EXPRESS OR IMPLIED AND SAMSUNG DISCLAIMS ALL WARRANTIES INCLUDING, BUT NOT LIMITED TO, ANY IMPLIED WARRANTIES OF MERCHANTABILITY, INFRINGEMENT OR FITNESS FOR A PARTICULAR PURPOSE. NO WARRANTY OR GUARANTY GIVEN BY ANY PERSON, FIRM OR CORPORATION WITH RESPECT TO THIS PRODUCT SHALL BE BINDING ON SAMSUNG. SAMSUNG SHALL NOT BE LIABLE FOR LOSS OF REVENUE OR PROFITS, FAILURE TO REALIZE SAVINGS OR OTHER BENEFITS, OR ANY OTHER SPECIAL, INCIDENTAL OR CONSEQUENTIAL DAMAGES CAUSED BY THE USE, MISUSE OR INABILITY TO USE THIS PRODUCT, REGARDLESS OF THE LEGAL THEORY ON WHICH THE CLAIM IS BASED, AND EVEN IF SAMSUNG HAS BEEN ADVISED OF THE POSSIBILITY OF SUCH DAMAGES. NOR SHALL RECOVERY OF ANY KIND AGAINST SAMSUNG BE GREATER IN AMOUNT THAN THE PURCHASE PRICE OF THE PRODUCT SOLD BY SAMSUNG AND CAUSING THE ALLEGED DAMAGE. WITHOUT LIMITING THE FOREGOING, PURCHASER ASSUMES ALL RISK AND LIABILITY FOR LOSS, DAMAGE OR INJURY TO PURCHASER AND PURCHASER'S PROPERTY AND TO OTHERS AND THEIR PROPERTY ARISING OUT OF THE USE, MISUSE OR INABILITY TO USE THIS PRODUCT. THIS LIMITED WARRANTY SHALL NOT EXTEND TO ANYONE OTHER THAN THE ORIGINAL PURCHASER OF THIS PRODUCT, IS NONTRANSFERABLE AND STATES YOUR EXCLUSIVE REMEDY.

Some provinces or territories may or may not allow limitations on how long an implied warranty lasts, or the exclusion or limitation of incidental or consequential damages, so the above limitations or exclusions may not apply to you. This warranty gives you specific legal rights, and you may also have other rights which vary from state to state. User Replaceable Parts may be sent to the customer for unit repair. If necessary, a Service Engineer can be dispatched to perform service.

To obtain warranty service, please contact SAMSUNG at:

Samsung Electronics America, Inc.
85 Challenger Road Ridgefield Park, NJ 07660
1-800-SAMSUNG (726-7864) and www.samsung.com/us/support

Warranty (CANADA)

PLEASE DO NOT DISCARD. THIS PAGE REPLACES THE WARRANTY PAGE IN THE USE & CARE GUIDE

SAMSUNG ELECTRIC OVEN

LIMITED WARRANTY TO ORIGINAL PURCHASER

This SAMSUNG brand product, as supplied and distributed by SAMSUNG ELECTRONICS CANADA, INC. (SAMSUNG) and delivered new, in the original carton to the original consumer purchaser, is warranted by SAMSUNG against manufacturing defects in materials and workmanship for a limited warranty period of:

One (1) Year Parts and Labor

This limited warranty begins on the original date of purchase, and is valid only on products purchased and used in the CANADA. To receive warranty service, the purchaser must contact SAMSUNG for problem determination and service procedures. Warranty service can only be performed by a SAMSUNG authorized service center. The original dated bill of sale must be presented upon request as proof of purchase to SAMSUNG or SAMSUNG's authorized service center. Samsung will provide in-home service during the warranty period at no charge subject to availability within the contiguous CANADA. In home service is not available in all areas. To receive in home service, the product must be unobstructed and accessible to the service agent. If service is not available Samsung may elect to provide transportation of the product to and from an authorized service center.

Warranty (CANADA)

SAMSUNG will repair or replace this product, at our option and at no charge as stipulated herein, with new or reconditioned parts or products if found to be defective during the limited warranty period specified above. All replaced parts and products become the property of SAMSUNG and must be returned to SAMSUNG. Replacement parts and products assume the remaining original warranty, or ninety (90) days, whichever is longer. This limited warranty covers manufacturing defects in materials and workmanship encountered in normal, noncommercial use of this product and shall not apply to the following: damage which occurs in shipment; delivery and installation; applications and uses for which this product was not intended; altered product or serial numbers; cosmetic damage or exterior finish; accidents, abuse, neglect, fire, water, lightning or other acts of nature; use of products, equipment, systems, utilities, services, parts, supplies, accessories, applications, installations, repairs, external wiring or connectors not supplied or authorized by SAMSUNG which damage this product or result in service problems; incorrect electrical line voltage, fluctuations and surges; customer adjustments and failure to follow operating instructions, maintenance and environmental instructions that are covered and prescribed in the instruction book; product removal and reinstallation; problems caused by pest infestations, and overheating or overcooking by user. This limited warranty shall not cover cases of incorrect electric current, voltage or supply, light bulbs, house fuses, house wiring, cost of a service call for instructions, or fixing installation errors. SAMSUNG does not warrant uninterrupted or error-free operation of the product.

EXCEPT AS SET FORTH HEREIN THERE ARE NO WARRANTIES ON THIS PRODUCT EITHER EXPRESS OR IMPLIED AND SAMSUNG DISCLAIMS ALL WARRANTIES INCLUDING, BUT NOT LIMITED TO, ANY IMPLIED WARRANTIES OF MERCHANTABILITY, INFRINGEMENT OR FITNESS FOR A PARTICULAR PURPOSE. NO WARRANTY OR GUARANTY GIVEN BY ANY PERSON, FIRM OR CORPORATION WITH RESPECT TO THIS PRODUCT SHALL BE BINDING ON SAMSUNG. SAMSUNG SHALL NOT BE LIABLE FOR LOSS OF REVENUE OR PROFITS, FAILURE TO REALIZE SAVINGS OR OTHER BENEFITS, OR ANY OTHER SPECIAL, INCIDENTAL OR CONSEQUENTIAL DAMAGES CAUSED BY THE USE, MISUSE OR INABILITY TO USE THIS PRODUCT, REGARDLESS OF THE LEGAL THEORY ON WHICH THE CLAIM IS BASED, AND EVEN IF SAMSUNG HAS BEEN ADVISED OF THE POSSIBILITY OF SUCH DAMAGES. NOR SHALL RECOVERY OF ANY KIND AGAINST SAMSUNG BE GREATER IN AMOUNT THAN THE PURCHASE PRICE OF THE PRODUCT SOLD BY SAMSUNG AND CAUSING THE ALLEGED DAMAGE. WITHOUT LIMITING THE FOREGOING, PURCHASER ASSUMES ALL RISK AND LIABILITY FOR LOSS, DAMAGE OR INJURY TO PURCHASER AND PURCHASER'S PROPERTY AND TO OTHERS AND THEIR PROPERTY ARISING OUT OF THE USE, MISUSE OR INABILITY TO USE THIS PRODUCT. THIS LIMITED WARRANTY SHALL NOT EXTEND TO ANYONE OTHER THAN THE ORIGINAL PURCHASER OF THIS PRODUCT, IS NONTRANSFERABLE AND STATES YOUR EXCLUSIVE REMEDY.

Some states do not allow limitations on how long an implied warranty lasts, or the exclusion or limitation of incidental or consequential damages, so the above limitations or exclusions may not apply to you. This warranty gives you specific legal rights, and you may also have other rights which vary from state to state.

To obtain warranty service, please contact SAMSUNG at:

Samsung Electronics Canada Inc.
2050 Derry Road West, Mississauga, Ontario L5N 0B9 Canada
1-800-SAMSUNG (726-7864) and www.samsung.com/ca/support (English)
www.samsung.com/ca_fr/support (French)

Open Source Announcement

The software included in this product contains open source software. You may obtain the complete corresponding source code for a period of three years after the last shipment of this product by sending an email to <mailto:oss.request@samsung.com>.

It is also possible to obtain the complete corresponding source code in a physical medium such as a CD-ROM; a minimal charge will be required.

The following URL <http://opensource.samsung.com/opensource/SimpleConnectTP/seq/0> leads to the download page of the source code made available and open source license information as related to this product. This offer is valid to anyone in receipt of this information.





Scan this with your smartphone

Scan the QR code* or visit
www.samsung.com/spsn
to view our helpful
How-to Videos and Live Shows

* Requires reader to be installed on your
smartphone

Please be advised that the Samsung warranty does NOT cover service calls to explain product operation, correct improper installation, or perform normal cleaning or maintenance.

QUESTIONS OR COMMENTS?

COUNTRY	CALL	OR VISIT US ONLINE AT
U.S.A Consumer Electronics	1-800-SAMSUNG (726-7864)	www.samsung.com/us/support
CANADA	1-800-SAMSUNG (726-7864)	www.samsung.com/ca/support (English) www.samsung.com/ca_fr/support (French)



DG68-00857A-01