



Refrigerator

User manual

Free Standing Appliance

SAMSUNG

Contents

Safety information	4
Important safety symbols and precautions:	4
State of California Proposition 65 Warning (US only)	4
Critical installation warnings	5
Installation cautions	7
Critical usage warnings	7
Usage cautions	11
Cleaning cautions	12
Critical disposal warnings	13
1. Regulatory Notice	14
Installation	16
Your refrigerator at a glance	16
Door removal for entrance	18
Step-by-step installation	26
Operations	35
User interface	35
Samsung Smart Home	44
SMART GRID Function (Demand Response)	47
Recommendations for voice recognition	51
Samsung Family Hub	51
Special features	53
Maintenance	58
Handling and care	58
Cleaning	62
Replacement	63



Troubleshooting	66
General	66
Samsung Smart Home	70
Samsung Family Hub	71
Smart Grid	72
LCD	73
Do you hear abnormal sounds from the refrigerator?	74
Warranty (USA)	76
WARRANTY ON SAMSUNG REFRIGERATOR	76
Open Source Announcement	79



Safety information

- Before using your new Samsung Refrigerator, please read this manual thoroughly to ensure that you know how to operate the features and functions that your new appliance offers safely and efficiently.
- This appliance is not intended for use by persons (including children) with reduced physical, sensory, or mental capabilities, or those who lack experience and knowledge, unless they have been given supervision or instruction concerning the use of the appliance by a person responsible for their safety.
- Because the following instructions cover various models, the characteristics of your refrigerator may differ slightly from the refrigerator described in this manual.
- If you have any question, contact us at 1-800-SAMSUNG or find help and information online at www.samsung.com.
- R-600a or R-134a is used as a refrigerant. Check the compressor label on the rear of the appliance or the rating label inside the fridge to see which refrigerant is used for your refrigerator. If this product contains flammable gas (Refrigerant R-600a), contact your local authority in regard to safe disposal of this product.
- It is hazardous for anyone other than an Authorized Service Person to service this appliance.

Important safety symbols and precautions:

Please follow all safety instructions in this manual. This manual uses the following safety symbols.

WARNING

Hazards or unsafe practices that may result in **severe personal injury, property damage, and/or death.**

CAUTION

Hazards or unsafe practices that may result in **severe personal injury and/or property damage.**

NOTE

Useful information that helps users understand or benefit from the refrigerator.

These warning signs are here to prevent injury to you and others.

Please follow them carefully.

After reading this section, keep it in a safe place for future reference.

State of California Proposition 65 Warning (US only)

WARNING : This product contains chemicals known to the State of California to cause cancer and birth defects or other reproductive harm.

Critical installation warnings

WARNING

- Do not install the refrigerator in a damp location or place where it may come in contact with water.
 - Deteriorated insulation on electrical parts may cause an electric shock or fire.
- Do not place this refrigerator in direct sunlight or expose it to the heat from stoves, room heaters, or other appliances.
- Do not plug several appliances into the same multiple power strip. The refrigerator should always be plugged into its own individual electrical outlet which has a voltage rating that matches the voltage listed on the refrigerator's rating plate.
 - This provides the best performance and also prevents overloading of house wiring circuits, which could overheat the wires and cause a fire hazard.
- If the wall socket is loose, do not insert the power plug.
 - There is a risk of electric shock or fire.
- Do not use a power cord that has cracks or abrasion damage along its length or at either end.
- Do not bend the power cord excessively or place heavy objects on it.
- Do not pull or excessively bend the power cord.
- Do not twist or tie the power cord.
- Do not hook the power cord over a metal object, place a heavy object on the power cord, insert the power cord between objects, or push the power cord into the space behind the appliance.
- When moving the refrigerator, be careful not to roll over or damage the power cord.
 - This may result in an electric shock or fire.
- Never unplug your refrigerator by pulling on the power cord. Always grip the plug firmly and pull straight out from the outlet.
 - Damage to the cord may cause a short-circuit, fire, and/or electric shock.
- Do not store explosive substances such as aerosol cans with a flammable propellant in this appliance.
- Do not install this appliance near a heater or flammable material.
- Do not install this appliance in a location where gas may leak.
 - This may result in an electric shock or fire.
- This refrigerator must be properly located and installed in accordance with the instructions in this manual before you use it.
- Connect the power plug in the proper position with the cord hanging down.
 - If you connect the power plug upside down, the wire can get cut off and cause a fire or electric shock.

Safety information

- Make sure that the power plug is not crushed or damaged by the back of the refrigerator.
- Keep the packing materials out of reach of children.
 - There is a risk of death from suffocation if a child puts the packing materials on his or her head.
- The appliance must be positioned so that the plug is accessible after installation.
 - Failing to do so may result in an electric shock or fire due to electric leakage.
- Do not install this appliance in a humid, oily or dusty location, or in a location exposed to direct sunlight or to water (rain drops).
 - Deteriorated insulation on electrical parts may cause an electric shock or fire.
- If large amounts of dust or water enter the refrigerator, disconnect the power plug and contact your Samsung Electronics service center.
 - Otherwise there is a risk of fire.
- Do not stand on top of the appliance or place objects (such as laundry, lighted candles, lighted cigarettes, dishes, chemicals, metal objects, etc.) on the appliance.
 - This may result in an electric shock, fire, problems with the product, or injury.
- You need to remove all the protective plastic film before you initially plug the product in.
- Children should be supervised to ensure that they do not play with the snap rings used for door adjustment or the water tube clips.
 - There is risk of death by suffocation if a child swallows a snap ring or water tube clip. Keep the snap rings and water tube clips out of children's reach.
- The refrigerator must be safely grounded.
 - Always make sure that you have grounded the refrigerator before attempting to investigate or repair any part of the appliance. Power leakages can cause severe electric shock.
- Never use gas pipes, telephone lines, or other potential lightning attractors as an electrical ground.
 - You must ground the refrigerator to prevent any power leakages or electric shocks caused by current leakage from the refrigerator.
 - This may result in an electric shock, fire, explosion, or problems with the product.
 - Improper use of the grounding plug can result in a risk of electric shock. If it is necessary to use an extension cord, use only a 3-wire extension cord that has a 3-blade grounding plug and a 3-slot receptacle that will accept the plug on the appliance. The marked rating of the extension cord should be AC 115-120 V, 10 A, or more. If a grounding adapter is used, make sure the receptacle box is fully grounded.

-
- Plug the power plug into the wall socket firmly. Do not use a damaged power plug, damaged power cord, or loose wall socket.
 - This may result in an electric shock or fire.
 - If the power cord is damaged, have it replaced immediately by the manufacturer or one of its service agents.
 - Only a qualified technician or service company should be allowed to change the fuse in the refrigerator.
 - Failing to do so may result in an electric shock or personal injury.

Installation cautions

CAUTION

- Allow sufficient space around the refrigerator and install it on a flat surface.
 - Keep the ventilation space in the appliance enclosure or mounting structure clear of obstructions.
- After you have installed the refrigerator and turned it on, allow the appliance to stand for 2 hours before loading it with food.
- We strongly recommend you have a qualified technician or service company install the refrigerator.
 - Failing to do so may result in an electric shock, fire, explosion, problems with the product, or injury.
- Overloading one door may make the refrigerator fall, causing physical injury.

Critical usage warnings

WARNING

- Do not insert the power plug into a wall socket with wet hands.
 - This may result in an electric shock.
- Do not store articles on the top of the appliance.
 - When you open or close the door, the articles may fall and cause personal injury and/or material damage.
- Do not insert hands, feet or metal objects (such as chopsticks, etc.) into the bottom or the back of the refrigerator.
 - This may result in an electric shock or injury.
 - Any sharp edges may cause a personal injury.

Safety information

- Do not touch the inside walls of the freezer or products stored in the freezer with wet hands.
 - This may cause frostbite.
- Do not put a container filled with water on the refrigerator.
 - If spilled, there is a risk of fire or electric shock.
- Do not keep volatile or flammable objects or substances (benzene, thinner, propane gas, alcohol, ether, LP gas, and other such products) in the refrigerator.
 - This refrigerator is for storing food only.
 - This may result in fire or explosion.
- Children should be supervised to ensure that they do not play with the appliance.
 - Keep fingers out of "pinch point" areas. Clearances between the doors and cabinet are necessarily small. Be careful when you open the doors if children are in the area.
- Do not let children hang on the door or door bins. A serious injury may occur.
- Do not let children go inside the refrigerator. They could become trapped.
- Do not insert your hands into the area under the appliance.
 - Any sharp edges may cause personal injury.
- Do not store pharmaceutical products, scientific materials, or temperature sensitive products in the refrigerator.
 - Products that require strict temperature controls must not be stored in the refrigerator.
- Do not place or use electrical appliances inside the refrigerator/freezer, unless they are of a type recommended by the manufacturer.
- If you smell smoke, pull out the power plug immediately, and then contact your Samsung Electronics service center.
- If large amounts of dust or water enter the refrigerator, disconnect the power plug and contact your Samsung Electronics service center.
 - Otherwise there is a risk of fire.
- Do not let children step on a drawer.
 - The drawer may break and cause them to slip.
- Do not leave the doors of the refrigerator open while the refrigerator is unattended and do not let children enter the refrigerator.
- Do not allow babies or children go into a drawer.
 - It can cause death from suffocation by entrapment or personal injury.
- Do not overfill the refrigerator with food.
 - When you open the door, an item may fall out and cause personal injury or material damage.
- Do not spray volatile material such as insecticide onto the surface of the appliance.
 - As well as being harmful to humans, it may also result in an electric shock, fire, or problems with the product.



- Never put fingers or any objects into the water dispenser outlet, ice chute, or ice maker bucket.
 - It may cause a personal injury or material damage.
- Do not use or place any substances sensitive to temperature such as flammable sprays, flammable objects, dry ice, medicine, or chemicals near or inside the refrigerator.
- Do not use a hair dryer to dry the inside of the refrigerator. Do not place a lighted candle in the refrigerator to remove bad odors.
 - This may result in an electric shock or fire.
- Fill the water tank, ice tray, and water cubes with potable water only (tap water, mineral water, or purified water).
 - Do not fill the tank with tea, juice, or a sports drink. They can damage the refrigerator.
- Do not stand on top of the appliance or place objects (such as laundry, lighted candles, lighted cigarettes, dishes, chemicals, metal objects, etc.) on the appliance. This may result in an electric shock, fire, problems with the product, or injury. Do not put a container filled with water on the appliance.
 - If spilled, there is a risk of fire or electric shock.
- Do not use mechanical devices or any other means to accelerate the defrosting process, other than those recommended by the manufacturer.
- Do not damage the refrigerant circuit.
- Never stare directly at the UV LED lamp for long periods of time.
 - This may result in eye strain due to the ultraviolet rays.
- Do not put a fridge shelf into the refrigerator upside down. The shelf stopper will not work.
 - The glass shelf could fall and cause personal injury.
- Keep fingers out of "pinch point" areas. Clearances between the doors and cabinet are necessarily small. Be careful when you open the doors if children are in the area.
- If a gas leak is detected, avoid any naked flames or potential sources of ignition, and air the room in which the appliance is standing for several minutes.
 - Do not touch the appliance or power cord.
 - Do not use a ventilating fan.
 - A spark may result in an explosion or fire.
- Use only the LED Lamps provided by the manufacturer or its service agents.
- Bottles should be stored tightly together so that they do not fall over or out.
- This product is intended only for the storage of food in a domestic environment.
- Never put fingers or any objects into the water dispenser outlet, ice chute, or ice maker bucket.
 - This can cause a personal injury or material damage.



Safety information

- Do not attempt to repair, disassemble, or modify the refrigerator yourself.
 - Unauthorized modifications can cause safety problems. To reverse an unauthorized modification, we will charge the full cost of parts and labor.
- Do not use any fuse (such as cooper, steel wire, etc.) other than a standard fuse.
- If your refrigerator needs to be repaired or reinstalled, contact your nearest service center.
 - Failing to do so may result in an electric shock, fire, problems with the product, or injury.
- If the interior or exterior LED lamp has gone out, contact your nearest Samsung service center.
- If the refrigerator emits a burning smell or smoke, unplug the refrigerator immediately and contact a Samsung service center.
 - Failing to do so may result in an electric or fire hazards.
- Pull the power plug out of the socket before changing the interior lamps of the refrigerator.
 - Otherwise, there is a risk of electric shock.
- If you experience difficulty changing a non-LED light, contact a Samsung service center.
- If the product is equipped with LED lamps, do not disassemble the Lamp Covers and LED lamps yourself.
 - Contact a Samsung service center.
- Plug the power plug into the wall socket firmly.
- Do not use a damaged power plug, damaged power cord, or loose wall socket.
 - This may result in an electric shock or fire.

Usage cautions

CAUTION

- Do not re-freeze frozen foods that have thawed completely. Do not place carbonated or fizzy drinks in the freezer compartment. Do not put bottles or glass containers in the freezer.
 - When the contents freeze, the glass may break and cause personal injury.
- Use only the ice maker provided with the refrigerator.
- To get the best performance from the product:
 - Do not place food too close to the vents at the rear of the refrigerator as this can obstruct free air circulation in the refrigerator compartment.
 - Wrap food up properly or place it in airtight containers before putting it into the refrigerator.
 - Do not put glass bottles or carbonated beverages into the freezer. They can freeze and break. Broken beverage containers can cause injury.
 - Please observe maximum storage times and expiration dates of frozen goods.
- Do not put glass containers or bottles or carbonated beverages into the freezer.
 - The container may freeze and break, and this may result in injury.
- Service Warranty and Modification.
 - Any changes or modifications performed by a 3rd party on this finished appliance are not covered under Samsung warranty service, nor is Samsung responsible for safety issues that result from 3rd party modifications.
- Do not block the air vents inside the refrigerator.
 - If the air vents are blocked, especially with a plastic bag, the refrigerator can be over cooled. If a cooling period lasts too long, the water filter may break and cause water leakage.
- If the refrigerator is disconnected from the power supply, you should wait for at least five minutes before plugging it back in.
- If large amounts of water enter the refrigerator, pull out the power plug and contact a Samsung service center.
- Do not strike or apply excessive force to any glass surface.
 - Broken glass may result in a personal injury and/or property damage.
- Fill the water tank and ice cube trays with potable water only (tap water, mineral water, or purified water).
 - Do not fill the tank with tea, juice, or a sports drink. They can damage the refrigerator.
- If the refrigerator is flooded, shut off the power to the refrigerator and contact your nearest Samsung service center.
 - There is a risk of electric shock or fire.

Safety information

Cleaning cautions

CAUTION

- Do not spray water directly on the inside or outside the refrigerator.
 - There is a risk of fire or electric shock.
- Do not use a hair dryer to dry the inside of the refrigerator.
- Do not place a lighted candle in the refrigerator to remove bad odors.
 - This may result in an electric shock or fire.
- Do not spray cleaning products directly on the display.
 - Printed letters on the display may come off.
- If any foreign substance such as water has entered the appliance, unplug the power plug and contact your nearest service center.
 - Failing to do so may result in an electric shock or fire.
- Use a clean, dry cloth to remove any foreign matter or dust from the power plug blades. Do not use a wet or damp cloth when cleaning the plug.
 - Otherwise, there is a risk of fire or electric shock.
- Do not clean the appliance by spraying water directly onto it.
- Do not use benzene, thinner, or Clorox (bleach) to clean the refrigerator.
 - They may damage the surface of the appliance and may cause a fire.
- Never put fingers or any objects into the dispenser outlet.
 - This can cause a personal injury or material damage.
- Before cleaning or performing maintenance, unplug the appliance from the wall socket.
 - Failing to do so may result in an electric shock or fire.

Critical disposal warnings

WARNING

- **DANGER** : Risk of child entrapment. Before you throw away your old refrigerator or freezer:
 - Take off the doors and door latch.
 - Leave the shelves in place so that children cannot easily climb inside.
 - Children trapped inside a refrigerator can hurt themselves or suffocate to death.
- Please dispose of the packaging material from this product in an environmentally friendly manner.
- Ensure that none of the pipes on the back of the refrigerator are damaged prior to disposal.
- R-600a or R-134a is used as a refrigerant. Check the compressor label on the rear of the appliance or the rating label inside the fridge to see which refrigerant is used for your refrigerator. If this refrigerator contains flammable gas (Refrigerant R-600a), contact your local authority in regard to the safe disposal of this product.
- When disposing of this refrigerator, remove the door/door seals and door latch so that small children or animals cannot become trapped inside. Children should be supervised to ensure that they do not play with the appliance.
 - If trapped inside, the child could be injured or suffocate to death.
- Cyclopentane is used in the insulation. The gases in the insulation material require a special disposal procedure. Please contact your local authorities in regard to the environmentally safe disposal of this product.
- Keep all packaging materials well out of the reach of children, as packaging materials can be dangerous to children.
 - If a child places a bag over his or her head, the child could suffocate.

Safety information

1. Regulatory Notice

1.1 FCC Notice

FCC CAUTION:

Any changes or modifications not expressly approved by the party responsible for compliance could void the user's authority to operate the equipment.

Contains Transmitter Module FCC ID: A3LWCM730Q

This device complies with Part 15 of FCC Rules. Operation is Subject to the following two conditions:

- (1) This device may not cause harmful interference, and
- (2) This device must accept any interference received including interference that cause undesired operation.

For products available in the US and Canadian markets, only channels 1~11 are available. You cannot select other channels.

FCC STATEMENT:

This equipment has been tested and found to comply within the limits for a Class B digital device, pursuant to part 15 of the FCC Rules. These limits are designed to provide reasonable protection against harmful interference in a residential installation.

This equipment generates, uses, and can radiate radio frequency energy and, if not installed and used in accordance with the instructions, may cause harmful interference to radio communications. However, there is no guarantee that interference will not occur in a particular installation. If this equipment does cause harmful interference to radio or television reception, which can be determined by turning the equipment off and on, the user is encouraged to try to correct the interference by one or more of the following measures:

- Reorient or relocate the receiving antenna
- Increase the separation between the equipment and receiver
- Connect the equipment to an outlet that is on a different circuit than the receiver.
- Consult the dealer or an experienced radio/TV technician for help.

FCC RADIATION EXPOSURE STATEMENT:

This equipment complies with FCC radiation exposure limits set forth for an uncontrolled environment.

This equipment should be installed and operated so there is at least 8 inches (20 cm) between the radiator and your body. This device and its antennas must not be co-located or operated in conjunction with any other antenna or transmitter except in accordance with FCC multi-transmitter product procedures.



1.2 IC Notice

Contains Transmitter Module IC: 649E-WCM730Q

The term "IC" before the radio certification number only signifies that Industry Canada technical specifications were met. Operation is subject to the following two conditions : (1) this device may not cause interference, and (2) this device must accept any interference, including interference that may cause undesired operation of the device.

This Class B digital apparatus complies with Canadian ICES-003.

Cet appareil numérique de la classe B est conforme à la norme NMB-003 du Canada.

For products available in the US and Canadian markets, only channels 1~11 are available. You cannot select other channels.

IC RADIATION EXPOSURE STATEMENT:

This equipment complies with IC RSS-102 radiation exposure limits set forth for an uncontrolled environment. This equipment should be installed and operated so there is at least 8 inches (20 cm) between the radiator and your body. This device and it's antennas must not be co-located or operated in conjunction with any other antenna or transmitter except in accordance with FCC multi-transmitter product procedures.

SAVE THESE INSTRUCTIONS

Safety Information



Installation

Follow these instructions carefully to prevent accidents and to ensure the proper installation of this refrigerator.

⚠ WARNING

- Use the refrigerator only for its intended purpose as described in this manual.
- Any servicing must be performed by a qualified technician.
- Dispose of the product packaging material in compliance with the local regulations.
- To prevent electric shock, unplug the power cord before servicing.

Your refrigerator at a glance

📖 NOTE

Your refrigerator and the provided component parts of your refrigerator may differ from the illustrations in this manual, depending on the model and your country.

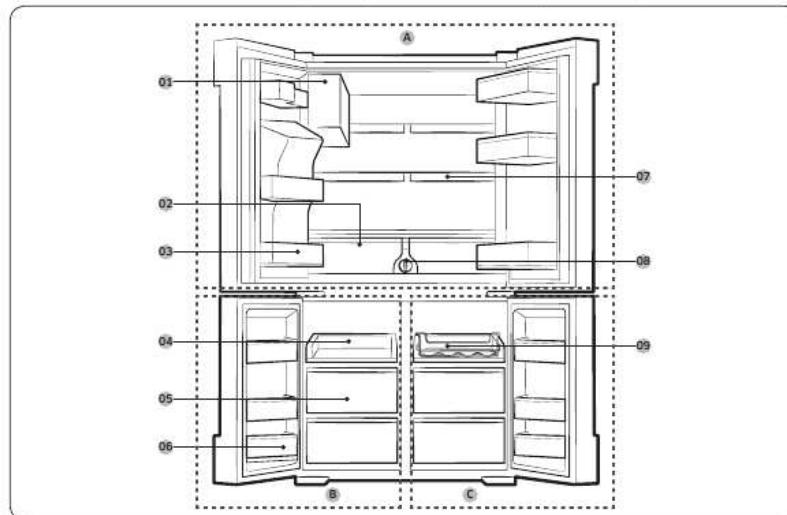

-
- | | |
|--|--------------------|
| 01 Auto Ice Maker (Ice Master) | A. Fridge |
| 02 EZ Fresh Vegetable & Fruit Drawers | B. Freezer |
| 03 Fridge Multi-Purpose Guard | C. FlexZone |
| 04 Easy Slide-Shelf | |
| 05 Dry Food and Meat Storage Drawers | |
| 06 Freezer door Bins | |
| 07 Quick Space Shelf | |
| 08 Water filter | |
| 09 Wine Rack | |

 **NOTE**

- For energy efficiency, keep all shelves, drawers, and baskets in their original positions.
- When closing the door, make sure the vertical hinged section is in the correct position to avoid scratching the other door.
- If the vertical hinged section is reversed, put it back into the correct position, and then close the door.
- Moisture may form at times on the vertical hinged section.
- If you close a door forcefully, the other door may open.
- When the door is opened, the interlock switch automatically disables the auger motor of the ice maker for safety reasons.
- If the internal or external LED lamp is out of order, contact a local Samsung service center.

Installation

Door removal for entrance

If the refrigerator cannot pass through the entrance to your home or kitchen due to its size, follow these instructions to remove and then re-install the refrigerator's doors. If you do not need to remove the doors, go to page 26 for the installation instructions.

Tools required (not provided)

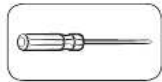

Phillips head screwdriver

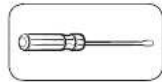

Flat-head screwdriver

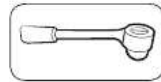

Socket wrench (10 mm)



Pliers



Allen wrench (4 mm)



Allen wrench (5 mm)

Detaching the fridge doors

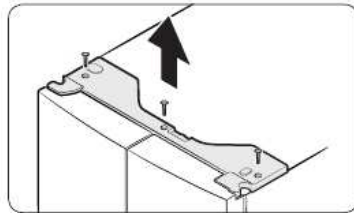

1. With the door closed, use a Phillips head screwdriver to remove the screws (x3) from the top cover. Pull up and remove the top cover with the connectors.

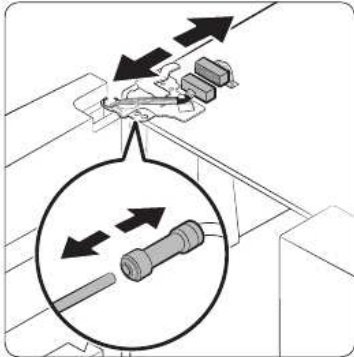

2. Disconnect the two wire connectors on the left door. The position of the connectors differs with the model.

⚠ CAUTION

- Do not remove both doors simultaneously. Make sure to remove one door at a time. Otherwise, one or both of the doors may fall and cause physical injury.
 - Make sure the refrigerator is off before disconnecting the connectors.
3. Disconnect the water tube from the coupler on the left door as shown.
 4. Gently draw up the clamp in several steps. To prevent finger injuries, do not apply a sudden force to the clamp.

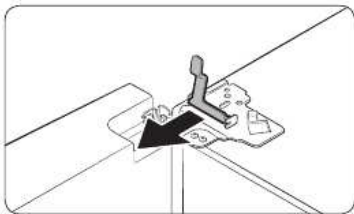
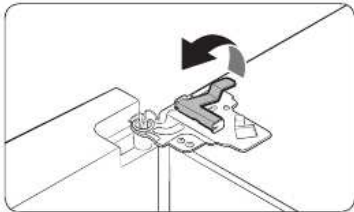

5. Pull up the clamp to remove.

Installation

Installation

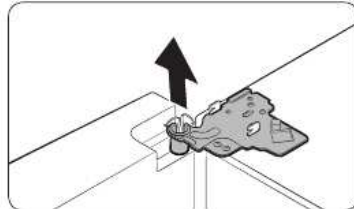

6. Open the door 90 degrees. While holding the door, pull up and remove the top hinge. Be careful not to damage the connector wires when you remove the hinge.

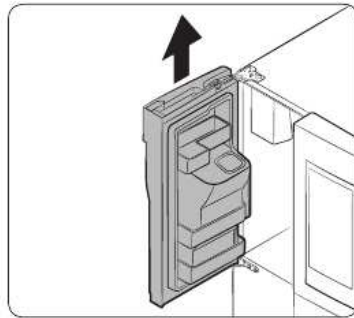

7. Gently pull up the door vertically to remove. Do not apply excessive force to the door. The door may fall, causing physical injury.
8. Lay the door down on a flat surface.
9. Repeat the steps above for the other door, except for Step 3. There is no water tube on the right side door.

Detaching the freezer doors

CAUTION

- Be sure to remove the fridge doors before removing the freezer doors.
- Use caution when disconnecting the bottom connectors.

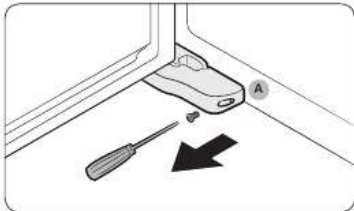

1. With the freezer door open, use a Phillips head screwdriver to remove the screw holding the cover (A) of the adjustable leg.

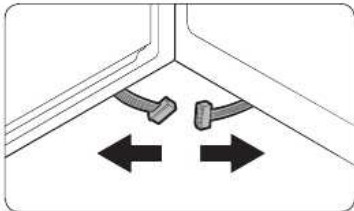

2. Disconnect the wire connectors.

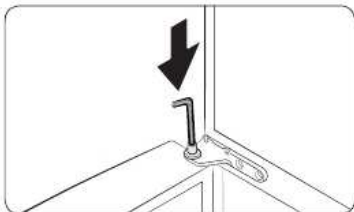

3. Locate the hinge shaft. While holding the door with one hand, use a flat-head screwdriver or wrench to press the shaft down. Make sure to hold the door to prevent the door from falling.

Installation

Installation

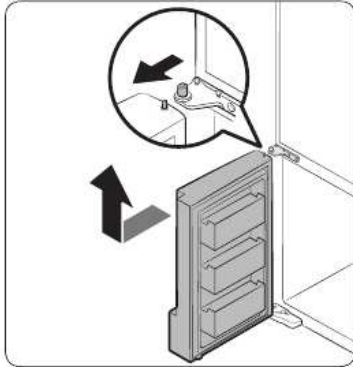

4. To prevent contact with the middle hinge, slightly tilt the door to the front, and then lift it up to remove.
5. Repeat the steps above for the other door.

Re-attaching the freezer doors

CAUTION

- Before re-attaching the doors, make sure all the electrical connectors are properly connected.
- The freezer doors must be re-attached before the fridge doors.
- Be careful not to damage or step on the wires during this process.

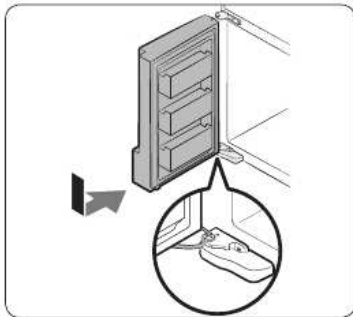

1. Insert the freezer door into the bottom hinge while pushing the freezer door in the direction of the arrow.

CAUTION

- Be careful not to damage or step on the wires during this process.

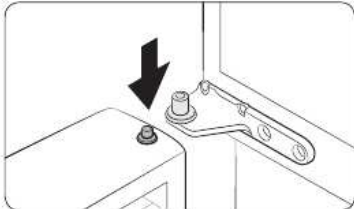

2. While pressing the hinge shaft down, position the door so that the hinge shaft is below the shaft hole in the middle hinge. Release the hinge shaft so that it enters the shaft hole.

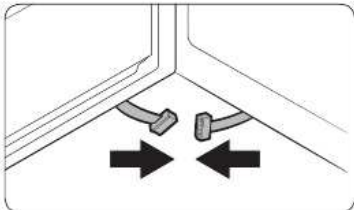

3. With the door open, connect the bottom connectors in the direction of the arrows.

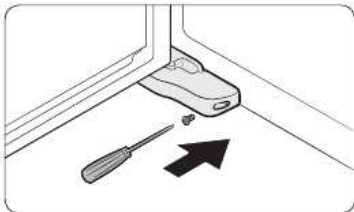

4. Attach the levelling foot cover using a Phillips head screwdriver. Be careful not to damage or step on the connectors.
5. Repeat the steps above for the other door.

Installation

Installation

Re-attaching the fridge doors

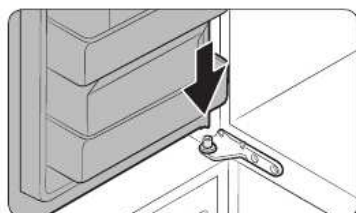

1. While holding the door open by more than 90 degrees, insert the shaft on the middle hinge into the hole on the bottom of the door.

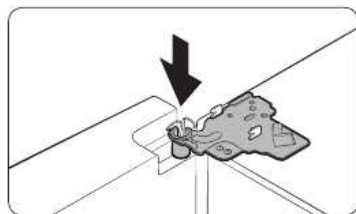

2. Put the top hinge into position on the top of the refrigerator, and then insert the hinge shaft into the top hole of the door. Make sure the wires from the door pass through the hole in the hinge shaft.

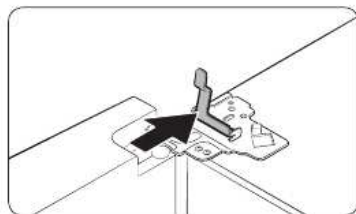

3. Insert the clamp in the direction of the arrow.

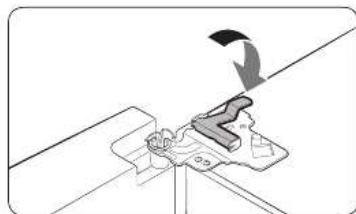

4. Push back the clamp as shown.

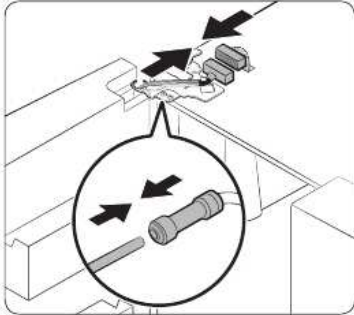

5. Connect the wire connectors.

⚠ CAUTION

- Make sure the wire connectors are connected properly. Otherwise, the display will not operate.

6. Connect the water tube.

⚠ CAUTION

- To prevent water leaks, make sure the red clips tighten the coupler properly.
- Keep the clips out of children's reach.

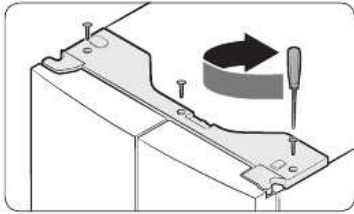

7. Repeat the above steps for the other door, except for Step 6. The right door does not have a water tube.

8. Attach the top cover with the front side first, and then press down on its back to get it into position. Then, tighten the screws (x3).

Installation

Installation

Step-by-step installation

STEP 1 Select a site

The site must:

- Have a solid level surface without carpeting or flooring that may obstruct ventilation
- Be out of direct sunlight
- Have adequate room for opening and closing the door
- Be away from any heat source
- Provide room for maintenance and servicing
- Have a temperature range between 50 °F (10 °C) and 110 °F (43 °C)

Clearance

See the pictures and table below and on the next page for installation space requirements.

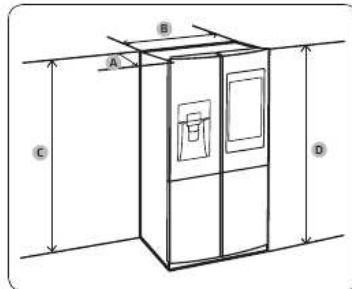

Model	RF22M*	RF28M*
Depth "A"	28 ⁷ / ₈ " (733 mm)	34 ³ / ₄ " (871 mm)
Width "B"	35 ³ / ₄ " (908 mm)	35 ³ / ₄ " (908 mm)
Height "C"	70 ³ / ₄ " (1797 mm)	70 ³ / ₄ " (1797 mm)
Overall Height "D"	71 ⁷ / ₈ " (1825 mm)	71 ⁷ / ₈ " (1825 mm)

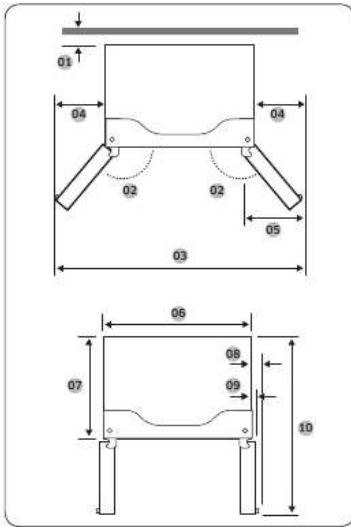

	RF22M*	RF28M*
01	2" (50 mm)	2" (50 mm)
02	125°	125°
03	59 5/8" (1515 mm)	59 5/8" (1515 mm)
04	11 7/8" (303 mm)	11 7/8" (303 mm)
05	12" (305 mm)	12" (305 mm)
06	35 3/4" (908 mm)	35 3/4" (908 mm)
07	24" (610 mm)	29 3/8" (748 mm)
08	2 3/4" (70 mm)	2 3/4" (70 mm)
09	1 3/4" (43 mm)	1 3/4" (43 mm)
10	42 5/8" (1083 mm)	48 1/8" (1221 mm)

NOTE

The measurements of your refrigerator may differ from those listed above, depending on the measuring method.

Installation

Installation

STEP 2 Flooring



- The surface of the installation location must support a fully loaded refrigerator.
- To protect the floor, put a large piece of cardboard under each leg of the refrigerator when you move it for installation.
- To protect the floor once the refrigerator is in its final position, do not move it unless necessary. If you have to move it, place thick paper or cloth such as an old carpet, along the movement path.

NOTE

If the refrigerator cannot pass through entrance to your home or kitchen due to its size, see **Door removal for entrance** on page 18.

STEP 3 Adjust the levelling feet

⚠ CAUTION

- When installed, the refrigerator must be leveled on a flat, solid floor. Not leveling the refrigerator can cause damage to the refrigerator or physical injury.
- Levelling must be performed with the refrigerator empty. Make sure no food items are inside the refrigerator.
- For safety reasons, adjust the front side a little higher than the rear side.

Level the refrigerator using the special screws (levellers) on the front legs. Use a flat-head screwdriver to turn the levellers.

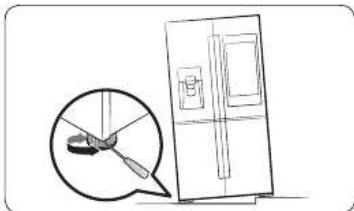

- To adjust the height of the left side: Insert a flat-head screwdriver into the leveller of the left side front leg. Turn the leveller clockwise to raise or turn it counterclockwise to lower.
- To adjust the height of the right side: Insert a flat-head screwdriver into the leveller of the right side front leg. Turn the leveller clockwise to raise or turn it counterclockwise to lower.

Installation

STEP 4 Adjust the door height as well as the door gap

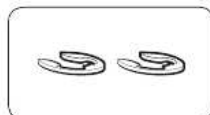

Snap ring

The height of a door can be adjusted using the provided snap rings, which come in 4 different sizes (1 mm, 1.5 mm, 2 mm, and 2.5 mm).

To adjust the height of a door

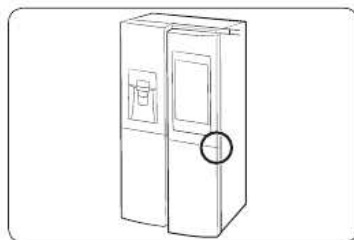

1. Check the height difference between the doors, and then raise and hold the lower door.

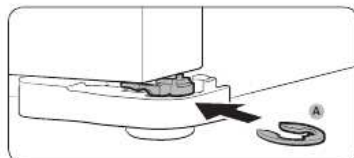

2. Insert a suitable-sized **snap ring (A)** between the door and the hinge as shown.

⚠ CAUTION

- Insert only one snap ring. If you insert two or more snap rings, the rings may slip out or make a rubbing noise.
- Keep the snap rings out of children's reach and keep them for future use.
- Do not raise the door too much. The door can contact and damage the top cover.

To correct the door gap

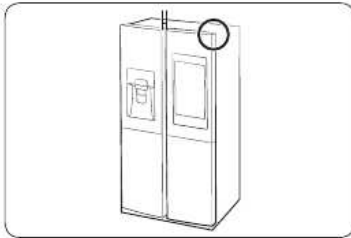

Door gaps can be corrected using the gap bolt on the top right corner of the refrigerator.

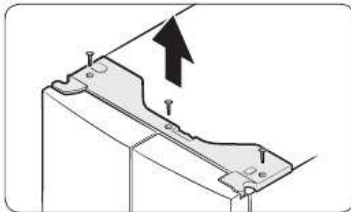

1. With the door closed, use a Phillips head screwdriver to remove the 6 screws in the **top cover**. Then, carefully remove the **top cover** along with the wire connectors.

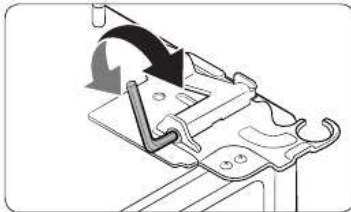

2. Use a 4 mm **Allen wrench** (not provided) to correct the door gap between two doors.
 - To widen the gap, turn the gap bolt clockwise.
 - To narrow the gap, turn the gap bolt counterclockwise.
3. When done, reinsert the top cover, and then reinsert the screws that hold it in place. Tighten the screws.

⚠ CAUTION

The electrical connectors must be left intact during this process. Use caution so you don't tangle the connector wires or peel off the coating.

Installation

STEP 5 Connect the water dispenser line

A water dispenser with a filter is one of the helpful features on your new refrigerator. To help promote better health, the water filter removes unwanted particles from your water. However, it does not sterilize or destroy microorganisms. You may need to purchase a water purifying system to do that.

The water line also connects to the ice maker. For the ice maker to operate properly, a water pressure of 20-125 psi is required.

If the refrigerator is installed in an area with low water pressure (below 20 psi), you can install a booster pump to compensate for the low pressure.

After you have connected the water line, make sure the water storage tank inside the refrigerator is properly filled. To do this, press the water dispenser lever until the water runs from the water outlet.

NOTE

- Water line installation kits are available at extra cost from your retailer. We recommend using a water line installation kit that contains copper tubing and a 6 mm (1/4") compression nut.
- Use the new hose-sets supplied with the appliance only. Do not re-use an old hose set.

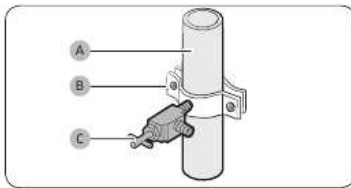

1. Shut off the main water source.
2. Insert the **pipe clamp (B)** and the **shut off valve (C)** into the cold water line (A).

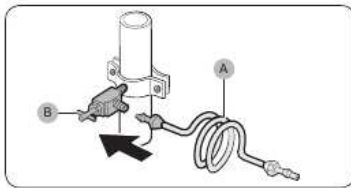

3. Connect the **water line installation kit (A)** to the **shut off valve (B)**.

Connect the water supply line to the refrigerator

There are several items you must purchase to complete this connection. You may find these items sold as a kit at your local hardware store.

Copper Tubing	<ul style="list-style-type: none">• 3/4" copper tubing• 3/4" compression nut (1 pc)• Ferrule (2 pc)
Plastic Tubing	<ul style="list-style-type: none">• 3/4" plastic tubing → Molded end (Bulb)• 3/4" compression nut (1pc)

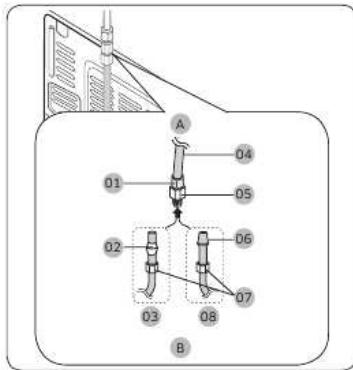

- A. Refrigerator
- B. Household water supply line
- 01 Compression Nut (3/4") (Assembled)
- 02 Ferrule (Not supplied)
- 03 Copper tubing (Not supplied)
- 04 Plastic Tubing (Assembled)
- 05 Compression Fitting (Assembled)
- 06 Molded end (Bulb)
- 07 Compression nut (B) (3/4") (Not supplied)
- 08 Plastic Tubing (A) (Not supplied)

1. Connect the household water line to the assembled compression fitting.
 - If you are using copper tubing, slip the **compression nut (B)** (not supplied) and **ferrule** (not supplied) on the copper tubing (not supplied) as shown.
 - If you are using plastic tubing (A), insert the molded end (Bulb) of the plastic tubing (A) into the compression fitting.

⚠ CAUTION

If you use plastic tubing, (A) do not use it without the molded end (Bulb).

2. Tighten the **compression nut (B)** onto the **compression fitting**. Do not over-tighten the **compression nut (B)**.
3. Turn the water on and check for any leakage. If you find water drops or leakage in the connection areas, turn off the main water supply. Check the connections and, if necessary, tighten.

Installation

Installation

4. Flush 1 gallon of water through the filter before drinking or using the water from the refrigerator. (Flush approximately 6 minutes.) To flush, press a large glass or cup against the water dispenser lever. Fill the glass, empty it, and then repeat.
5. After you turn on the refrigerator, let the ice maker make ice for 1 to 2 days. Over that period of time, throw out the first 1 or 2 buckets of ice the ice maker makes to ensure all impurities have been removed from the water line.

NOTE

Only connect the water line to a potable water source.

- If you have to repair or disassemble the water line, cut off $\frac{1}{4}$ " of the plastic tubing to make sure you get a snug, leak-free connection.
- You can test the water line quickly using a paper cup. Under normal conditions, the water dispenser can fill a 5 $\frac{3}{4}$ oz. (170 cc) cup in about 10 seconds.

STEP 6 Initial settings

After you complete the following steps, the refrigerator should be fully functional.

1. Plug the power cord into the wall socket to turn the refrigerator on.
2. Open the door, and check if the interior light lights up.
3. Set the temperature to the coldest setting, and then wait for about an hour. Then, the freezer will be slightly chilled, and the motor should be running smoothly.
4. Wait until the refrigerator reaches the set temperature. Now the refrigerator is ready to use.

STEP 7 Final check

When installation is complete, confirm that:

- The refrigerator is plugged into an electrical outlet and grounded properly.
- The refrigerator is installed on a flat, level surface with appropriate clearance between it and any walls or cabinets.
- The refrigerator is level and is sitting firmly on the floor.
- The door opens and closes freely, and the interior light turns on automatically when you open the door.

Operations

User interface

NOTE

- For detailed information about the refrigerator's functions, and apps, see the on-screen user manual available on the LCD display of your refrigerator.
- The content of apps and widgets and their design is subject to change. Support for apps and widgets may be discontinued without notice, depending on the content provider's policy.
- Children's use of the refrigerator's functions, apps, and services must be supervised by adults.
- The PANDORA apps are only available in the United States.



- 01 Home screen
- 02 Task bar

Operations

Operations

01 Home screen



01 Apps & Widgets

- Tap a desired app or widget to launch it.
- Tap and hold an app or widget to enter Edit mode. A grid appears. In Edit mode, you can drag and drop an app or widget to a new position on the grid. When you move the app or widget to a new grid location, the location turns blue if it is available. If it is not available, it turns red.
- You can add an app or widget that has been removed from the All Apps list.

02 Status bar

- **Bluetooth** (⌘): Indicates Bluetooth connection status.
- **USB** (⌘): Indicates USB connection status.
- **Remote Management** (⌘): Turns on when Remote Management is enabled and running.

NOTE

The refrigerator supports USB memory that is formatted in the FAT32 or exFAT file systems. NTFS is not supported. Be sure to convert NTFS to FAT32 or exFAT before use.

- **Network** (⌘): Indicates network connection status in 5 levels (Off, 1-4).

02 Task bar



01 Microphone	Tap to turn on or turn off the voice recognition function. The microphone icon turns red when it is turned off.
02 Menu	Tap to display the menus available.
03 Home	<ul style="list-style-type: none">• Tap to open the Home screen.• Tap and hold to open the Task Manager. See the Task Manager section for details.
04 Return	Tap to return to the previous screen.
05 Notification	Tap to display the Quick Panel.

Operations

Fridge Manager

To access Fridge Manager, swipe the Home screen to the left, and then tap the **Fridge Manager** widget.



- On the Fridge Manager widget, the current fridge and freezer temperatures as well as active special functions are displayed.
- For detailed settings, tap the widget to open the Fridge Manager.



The Fridge Manager is a graphical representation of your refrigerator. The top half represents the refrigerator compartment, the bottom left the freezer compartment, and the bottom right the FlexZone. The temperature or mode settings for each are displayed over each section.

Fridge Manager At a Glance

01 Temperature

- Change the set temperature in the fridge, freezer, and FlexZone. You can also turn on and turn off the refrigerator's Power Cool function and the freezer's Power Freeze function.
- Power Freeze speeds up the freezing process at maximum fan speed. The freezer keeps running at full speed for several hours and then returns to the previous temperature.
 - To freeze large amounts of food, activate Power Freeze at least 20 hours before putting food in the freezer.

NOTE

Using Power Freeze increases power consumption. Make sure you turn it off so the freezer returns to its previous temperature if you do not need it any longer.

02 Special Features

View a short explanation of some of the refrigerator's special features.

03 Fridge Settings

Change many of the fridge's settings including settings for ice making, the door alarm, and the temperature units (°F or °C). See the next page for details.

04 External Conditions

Displays the external (ambient) temperature and humidity.

Operations

NOTE

The displayed conditions may differ from the actual temperature and humidity.

NOTE

Also displayed is the **Ice Off** (ice making off) indicator at the top, center. When the indicator displays **Ice Off**, the refrigerator's ice maker is turned off.

Ice Maker	Turns the icemaker on and off. Tap and drag the button to turn on or off. Note that if the ice bucket is full of ice, the refrigerator will not start making ice when you drag the button to On. Instead, it displays the Ice Making Off indicator on the main screen.
Dispenser Lock	Turns the ice and water dispensers on and off. Tap and drag the button to turn on or off.
Door Alarm	The door alarm sounds if you leave the door open. Tap and drag the button to turn on or off.
Temp. Unit	Switch the temperature scale between Celsius and Fahrenheit. Touch °F or °C to change the scale.
Water Filter	Provides a water filter replacement tutorial and lets you reset the water filter replacement indicator. Tap to open. NOTE After installing the water filter, tap Water Filter , and then tap RESET . Tapping RESET re-initializes the function that measures the time remaining until the water filter needs to be replaced again.
Self Check	Self Check is a self diagnoses function. Tap to open. Tap START to run.
Demand Response	Works with the Smart Grid energy saving manager. Tap to open. Tap and drag the button to turn on or off. See the Smart Grid section in this manual for more information.
Cooling Off	Cooling Off mode (also called Shop mode), is designed for use by retailers when they are displaying refrigerators on the shop floor. In Cooling Off mode, the refrigerator's fan motor and lights work normally, but the compressors do not run, and the refrigerator and freezer do not get cold. If Cooling Off is turned on, all cooling controls will turn to OFF on the Fridge Manager. Tap and drag the button to turn on or off.

Settings

Display	<ul style="list-style-type: none">You can set the screen brightness, wallpapers, auto wake-up, motion detector, and theme, duration and start time of the screen saver.
Sound	<ul style="list-style-type: none">Set the volume and equalizer and turn on or turn off the touch sound.
Wi-Fi	<ul style="list-style-type: none">Turn on or turn off a Wi-Fi connection. The current Wi-Fi network is listed first in the access point (AP) list.
Bluetooth	<ul style="list-style-type: none">Up to 4 recently paired Bluetooth devices are listed.To add a new device when 4 paired devices are listed, first unpair a paired device from the device list.Available devices are Bluetooth-enabled headsets, headphones, and speakers.
Voice	<ul style="list-style-type: none">Set the language of the Voice function and turn on or turn off voice feedback and voice wakeup.
Profiles	<ul style="list-style-type: none">You can add, edit, or delete a profile.
Parental Controls	<ul style="list-style-type: none">Enable or disable restrictions on Family Hub features and apps.
Language	<ul style="list-style-type: none">Select a preferred language. Available languages depend on the sales region.
Date and Time	<ul style="list-style-type: none">Make sure the Auto update function is on with a proper Wi-Fi network connection. Open the fridge door and locate the display reset button on the inner side of the door. Press the button and press again to reset the display. Then, the date and time will be synced by the time server.You can change the time zone through the Time zone menu.
About Device	<ul style="list-style-type: none">Make sure the Software Update function is on with a proper Wi-Fi network connection.When updates are available, the Update button becomes active. When updates are complete, the refrigerator restarts automatically.Legal information displays the Open Source License Agreement. Tap the list item to open the Open Source Announcement.
Easy Connection	<ul style="list-style-type: none">Easy Connection can be used with Samsung Smartphone apps, and allows you to connect your device to the same home Wi-Fi network that your smartphone is connected to.

Operations

Device Authentication	<ul style="list-style-type: none">• Device Authentication can be used with Samsung Smart TV apps where the privacy information on the refrigerator can be shared to the TV.• Availability of this function depends on the device model.
Clean screen mode	<ul style="list-style-type: none">• Turn on so you can clean the screen without activating any apps.
Accessibility	<ul style="list-style-type: none">• Set to turn on or off the screen reader function for blind and low-vision users.
Online Manual	<ul style="list-style-type: none">• The online manual will walk you through various menus and apps that the refrigerator provides directly on the display.
Factory Reset	<ul style="list-style-type: none">• Tap Reset to restart the refrigerator in Factory Data Reset mode. All user data will be removed permanently. Data that will be removed includes account information, memos, photos, and user settings. <p>⚠ CAUTION Once factory reset is complete, no user data can be recovered.</p>
Remote Management	<ul style="list-style-type: none">• Use Remote Management to allow a service representative to remotely diagnose problems and provide solutions.• Remote Management requires a Wi-Fi connection.• The Remote Management menu does not appear on models that do not support Remote Management.

Operations

Display reset (applicable models only)

If the display is not working correctly, try resetting the display. This may resolve the problem.

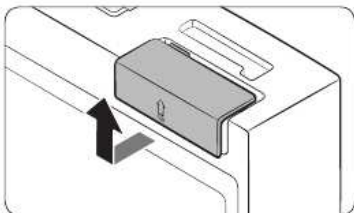

1. Open the right-side fridge door and locate the switch cover on the top right corner of the door.
2. Push up the cover to reveal the power switch.

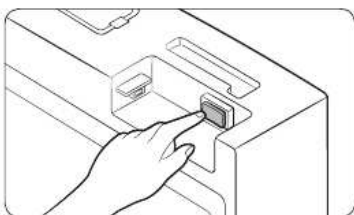

3. Turn the switch off, and then turn it on again.
4. Reinsert the switch cover. You will hear a click when the cover is in place.

Operations

Samsung Smart Home

Installation

Visit the Google Play Store, Galaxy Apps, or Apple App Store and search for "Samsung Smart Home". Download and install the Samsung Smart Home app provided by Samsung Electronics to your smart device.

NOTE

- The Samsung Smart Home app is designed for Android 4.0 (ICS) or higher, or iOS 8.0 or higher, and is optimized for Samsung smartphones (Galaxy S and Galaxy Note series).
- For improved performance, the Samsung Smart Home app is subject to change without notice or discontinued support according to the manufacturer's policy.
- Recommended encryption systems include WPA/TKIP and WPA2/AES. Any newer or non-standard Wi-Fi authentication protocols are not supported.
- Wireless networks may be affected by the surrounding wireless communication environment.
- If your Internet service provider has registered the MAC address of your PC or modem for identification, your Samsung Smart Refrigerator may fail to connect to the Internet. If this happens, contact your Internet service provider for technical assistance.
- The firewall settings of your network system may prevent your Samsung Smart Refrigerator from accessing the Internet. Contact your Internet service provider for technical assistance. If this symptom continues, contact a local Samsung service center or retailer.
- To configure the wireless access point (AP) settings, see the user manual of the AP (router).
- Samsung Smart Refrigerators support both Wi-Fi 2.4 GHz with IEEE 802.11 b/g/n and Soft-AP protocols. (IEEE 802.11 n is recommended.)
- Unauthorized Wi-Fi wireless routers may fail to connect to applicable Samsung Smart Refrigerators.

Samsung account

You are required to register your Samsung account to use the app. If you don't have a Samsung account, follow the app's onscreen instructions to create a free Samsung account.

Getting started

1. Run the Samsung Smart Home app and log in with your Samsung account. iPhone users are required to provide the login information each time they access the app.
2. Select **Add Device** and then tap **Refrigerator**.
3. Follow the onscreen instructions to provide the necessary information about the router, and then tap **Next**.
4. On the display of the refrigerator, access **Settings**, and then select **Easy Connection**.
5. When device registration is complete, the refrigerator icon will appear on the Samsung Smart Home app.
6. Tap the refrigerator icon to open the refrigerator page.

Refrigerator app

Integrated control

You can monitor and control your refrigerator at home and on the go.

- Tap the **refrigerator** icon in Samsung Smart Home to open the Refrigerator page.
- Check the operation status or notifications related to your refrigerator, and then change options or settings if necessary.

NOTE

Some options or settings of the refrigerator may not be available for remote control.

Operations

Operations

Category	Item	Description
Monitoring	Fridge temperature	Displays the current temperature setting of the fridge.
	Freezer temperature	Displays the current temperature setting of the freezer.
	FlexZone™ settings	Displays the settings of the FlexZone™.
	Diagnosis	Detects abnormal operations of the refrigerator.
	Energy monitoring	Checks the accumulated power consumption of the refrigerator for the last 180 days.
Functions	Ice making	You can turn the ice making function on or off, and check the current settings of the function.
		You can also check the status and progress of ice making.
	Power Cool	You can turn Power Cool on or off, and check the current settings.
Power Freeze	You can turn Power Freeze on or off, and check the current settings.	
Alarms	Abnormally high temperature	This alarm is triggered when the fridge, the freezer, or the FlexZone™ has abnormally high temperatures.
	Door opening	This alarm is triggered if the fridge or freezer door or the FlexZone™ door is left open for a specific time.
	Water filter replacement	This alarm reminds you that the water filter must be replaced.
View Inside		You can view the inside of the refrigerator and, by creating visible labels assigned to specific items with item-specific storage periods, keep track of item expiration dates so that you can use up and replace food items in a timely manner.
Shopping List		You can create and edit a shopping list.



SMART GRID Function (Demand Response)

When the refrigerator operates in SMART GRID (Demand Response) mode, the Energy Management Refrigerator function can control energy usage or delay the operation of some functions to save money when energy prices or demand are the highest.

NOTE

- You can deactivate the SMART GRID (Demand Response) function at any time using the Override On/Off function.
- To use the SMART GRID (Demand Response) function, you need a separate contract with your electric utility company.

In addition, to use the Smart Grid (Demand Response) function, you must register for the service with your electric company. The company must have an EMS (Energy Management System) that supports SEP (Smart Energy profile).

Using the SMART GRID (Demand Response) Function

This feature monitors energy prices and demand information from your utility company and sends notifications to the refrigerator to run high energy consuming tasks during off-peak times when electricity costs and demand are lower.

If the refrigerator receives a control signal from the utility company, the refrigerator will display the **DAL** (L3) ~ **TALR** (L4) levels on the refrigerator display and control the power consumption according to the level.

Exception condition: The **DAL** and **TALR** control signals from a utility company work as long as product performance is maintained.

If the refrigerator receives the SMART GRID (Demand Response) signal (**DAL** or **TALR**), the refrigerator will operate in Delay Appliance Load or Temporary Appliance Load Reduction mode.

- Delay Appliance Load (L3): The refrigerator responds to a **DAL** signal by providing a moderate load reduction for the duration of the delay period. This function controls functions that consume a lot of energy such as adjusting the Cooling system, running the defrost cycle, and making ice.
 - **DAL** mode is automatically deactivated after it lasts for the amount of time stipulated by the **DAL** signal (max. 4.5 hours) or when the Override function is turned on.



Operations

- Temporary Appliance Load Reduction (L4): The refrigerator responds to a **TALR** signal by aggressively reducing the load for a short time period. This function reduces energy consumption by stopping the compressor and controlling the functions that consume a lot of energy such as the defrost cycle and making ice.
 - **TALR** (L4) mode is automatically deactivated after it lasts for the received duration (max. 15 minutes), or when the Override function is turned on. The mode is immediately deactivated and the refrigerator returns to the normal state when the door is opened or closed, or the dispenser is used.

To check the MAC address

1. Tap the **Settings** icon on the Home screen.
2. Scroll down to and open **About Device**.
3. The screen displays (among others) the Wi-Fi MAC address.

Override Mode

When you want the refrigerator to ignore the SMART GRID (Demand Response) signal from the utility company, you can activate **VERRIDE** mode.

When you activate **VERRIDE** mode, the refrigerator ignores the SMART GRID (Demand Response) signal and is not controlled by the utility company.

Activating and deactivating Override mode

1. Tap the **Fridge Manager** icon.
2. On the bottom of the Fridge Manager screen, tap the **Fridge Settings** icon.
3. Tap **Demand Response**.
4. Slide the **DAL/TALR override** button to the **ON** or **OFF** position.

NOTE

- Alternatively, you can activate or deactivate **VERRIDE** mode using the Samsung Smart Home app and the Energy Management function. See the next page.



Using the Energy Management Function

The Energy Management function enables you to control and monitor your Energy Management refrigerator using the Smart Home app for your convenience.

NOTE

- To use the Energy Management refrigerator functions, you have to install the corresponding app first.
- Operational Status
 - You can check the DR and Override status.
 - Energy Consumption Reporting
 - Shows the accumulated power consumption. Power consumption data is updated every 5 minutes.

NOTE

The energy consumption report may differ from the power consumption specifications of the product depending on the operating environment and the quantity and type of stored food.

3. Delay Defrost Capability

- The Delay Defrost Capability function saves energy by delaying the defrost operation to a time specified by the user. You can configure the time, and this function will save energy during the specified period in a 24 hour cycle. If the time is not set, the function works with the default time settings. The default time settings are below:
 - 6 am to 10 am: November 1st to April 30th.
 - 3 pm to 7 pm: May 1st to October 31st.

To change the time setting for the Delay Defrost Capability

You can change the time setting for the Delay Defrost Capability on the app.

Operations

Provision for Open Access to the Connected Product Requirements

1. SGIP Open Standards (Smart Energy Profile 2.0 - <http://www.csep.org/>)
 - Energy Consumption Reporting
 - Demand Response
2. Samsung OPEN API
 - Operational Status, User Settings & Messages
 - ICE Maker Status: GET /devices/0/fridge/iceMaker
 - Door Open Alarm: GET /devices/0/Door/openState
 - DR Status: GET /devices/0/drlc
 - Delay Defrost Capability
 - Set Schedule of the Defrost Delay: POST /devices/0/fridge/defrostreservations
 - Get Schedule of the Defrost Delay : GET /devices/0/fridge/defrostreservations
 - Delete Schedule of the Defrost Delay: DELETE /devices/0/fridge/defrostreservations/<<id>>
 - Defrost Delay On/OFF: PUT /devices/0/fridge

Recommendations for voice recognition

Around the 'MIC' marked area of the refrigerator's display is a built-in microphone.

- Speak loud and clear towards the built-in microphone within 1 m from the refrigerator's display.
- Voice recognition may not be triggered or enabled at distances over 1 m or with low voices.
- Speak clearly at a regular pace. Reduce ambient noises, such as from the living-room TV.

Samsung Family Hub

Installation

Visit the Google Play Store, Galaxy Apps, or Apple App Store and search for "Samsung Family Hub". Download and install the Samsung Family Hub app provided by Samsung Electronics to your smart device.

NOTE

- The Samsung Family Hub app is designed for Android 4.4 (KitKat) or higher, or iOS 8.0 or higher, and is optimized for Samsung smartphones (Galaxy S and Galaxy Note series).
- For improved performance, the Samsung Family Hub app is subject to change without notice or support may be discontinued according to the manufacturer's policy.
- Wireless networks may be affected by the surrounding wireless communication environment.
- If your Internet service provider has registered the MAC address of your PC or modem for identification, your Samsung Smart Refrigerator may fail to connect to the Internet. If this happens, contact your Internet service provider for technical assistance.
- The firewall settings of your network system may prevent your Samsung Smart Refrigerator from accessing the Internet. Contact your Internet service provider for technical assistance. If this symptom continues, contact a local Samsung service center or retailer.

Operations

Samsung account

You are required to register your Samsung account to use the app. If you don't have a Samsung account, follow the app's onscreen instructions to create a free Samsung account.

NOTE

To connect your smartphone and the refrigerator, register your Samsung account in **Settings → Profiles**.

Item	Description
Calendar	You can share your schedule with your family.
To Do	You can create and edit a to-do list to your needs.
Memo	You can create and edit a memo to specific users.
Whiteboard	You can send White Board contents created from the refrigerator to your smartphone or vice versa.
Photo	You can send photos from your smartphone to the refrigerator.
View Inside	You can check the inner view of the refrigerator, and use different labels to register item-specific storage periods and keep track of them for managerial purposes.
Shopping List	You can create and edit a shopping list to your needs.

Special features

Water dispenser

With the water dispenser, you can dispense water without opening the fridge door.

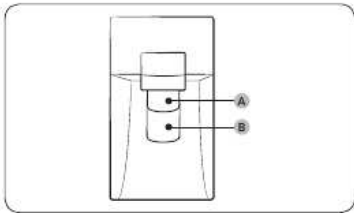

The water dispenser offers 3 options: chilled water, cubed ice, and crushed ice. If you do not want to dispense ice, simply press the **water lever (B)**.

With the Ice Maker enabled,

1. Press to select an ice type.
2. Put a water glass on the **ice lever (A)** and push it. Ice is dispensed from the dispenser.
3. If you want water, put the glass on the **water lever (B)** and push it. Water is dispensed from the dispenser.

NOTE

- To get ice and water, push the **ice lever (A)** first for ice, then move your glass down and press the **water lever (B)** for water.
- If you push both levers at once, only the first pushed lever operates.
- To prevent spills, wait 1 second before removing the glass after dispensing.
- Make sure the glass is in line with the dispenser to prevent the dispensed water from spilling out.
- If you do not use the water dispenser for 2-3 days, the dispensed water may have an abnormal smell or taste. This is not a system failure. Discard the first 1-2 glasses of water.

Operations

Ice maker

The refrigerator has a built-in ice maker that automatically dispenses ice so that you can enjoy filtered water with cubed or crushed ice.

Ice making

After you have installed your refrigerator and plugged it in, follow these instructions to ensure proper ice making and to keep the ice bucket full of ice:

1. Let the refrigerator run at least 24 hours without dispensing ice for optimal performance.
2. Dispense the first 4 to 6 ice cubes into a glass.
3. Wait another 8 hours and dispense another 4 to 6 ice cubes.
4. Then, wait another 16 hours and dispense the first glass-full of ice.

NOTE

- If you consume all the ice at once, you must wait 8 hours before dispensing the first 4 to 6 cubes. This ensures that the ice bucket is filled with ice properly.
- Ice cubes generated rapidly may look white, which is normal.

Diagnosis

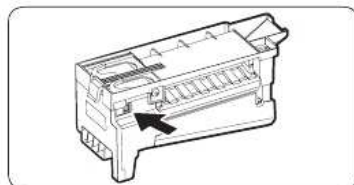

If ice does not dispense, first check the ice maker.

To check the ice maker

1. Press **Test** on the side of the ice maker. You will hear a chime (ding-dong) when you press the button.
2. You will hear another chime if the ice maker is operating properly.

CAUTION

- If the ice making chime rings repeatedly, contact the waterline installer or a local Samsung service center.
- Do not press **Test** repeatedly after the ice tray is filled with ice or water. Water may overflow or ice may jam.
- Do not put food in the ice bucket. The frozen food may damage the ice maker, especially when you open or close the door.
- When the refrigerator recovers power after a power failure, the ice bucket may contain a mix of melted and jammed ice cubes, which can prevent the ice maker from working properly. To prevent this, make sure to empty the ice bucket before using the ice maker again.

- Do not put fingers or any objects into the dispenser outlet or the ice maker. This can cause physical injury or property damage.
- When reinserting the ice maker tray, make sure that the tray is properly centered at the entrance. Otherwise, the tray can get stuck.

Ice Maker Off

To disable the icemaker, tap **Fridge Manager** > **Fridge Settings** > **Ice Making** on the Home screen, and then select **Off**. Make sure to empty the ice bucket.

Remaining ice cubes may clump together, making it difficult to remove them.

To remove the ice bucket

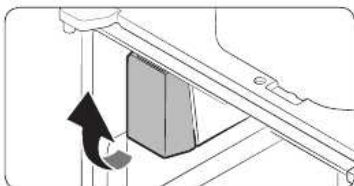

1. Hold the bottom of the ice bucket with one hand and hold the side with the other hand.
2. Gently lift it up and pull out.

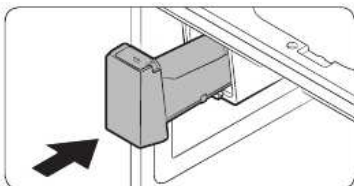

3. Remove the remaining ice cubes, and then put the ice bucket back into place.

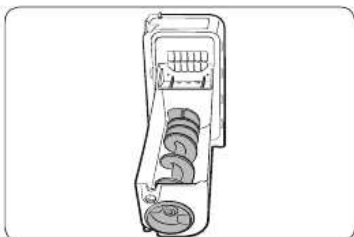

If the bucket does not fit in, turn the helix screw 90 degrees, and then try again.

NOTE

- Removal of the ice bucket does not affect the thermal and mechanical performance of the refrigerator.

Operations

Water clouding

Water supplied to the refrigerator flows through a core alkaline filter. During this filtering process, the water pressure of the water increases and the water becomes saturated with oxygen and nitrogen. This causes the water to look misty or cloudy temporarily when dispensed. This is normal and the water will look clear after a few seconds.

Wine Rack

The refrigerator ships with a wine rack, which can be positioned in one of 3 positions: under the shelf, in the partition guide, or on top of the sliding shelf of the FlexZone. The position or positions available to you depends on your model.

CAUTION

When you remove or insert the wine rack, make sure that the wine rack is empty.

Under the shelf

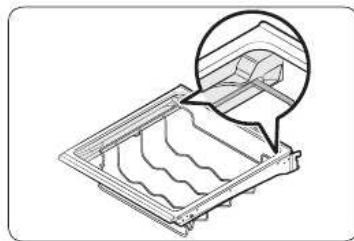

Insert the wine rack under the shelf of the fridge. Make sure to insert it all the way to the end as shown in the figure.

In the partition guide

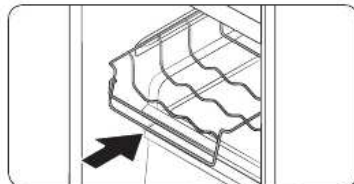

Insert the wine rack in the partition guide of the FlexZone.

- Make sure the front of the wine rack fits in the partition guide on the inner left-hand side of the FlexZone.
- Set the temperature of the FlexZone to **White Wine**.

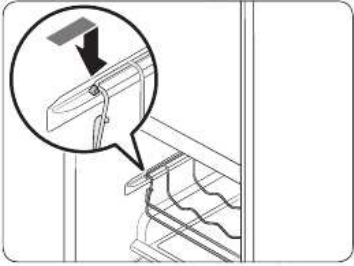

On the sliding shelf

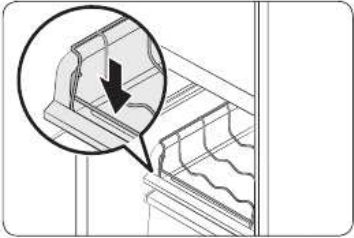

Insert the wine rack on top of the sliding shelf of the FlexZone, which is normally below the partition guide.

- Set the temperature of the FlexZone to **White Wine**.

⚠ CAUTION

- Do not store wine bottles in the freezer. The bottles can freeze and break, causing physical injury.
- Do not store wine bottles in two rows. The bottles may fall, causing physical injury.
- Do not store wine bottles taller than 13 in (330 mm) in height. The bottles may break when you close the door, causing physical injury.

Operations

Maintenance

Handling and care

Ice bucket

If you do not dispense ice for an extended period, ice may form clumps inside the bucket. If this happens, remove and empty the ice bucket.

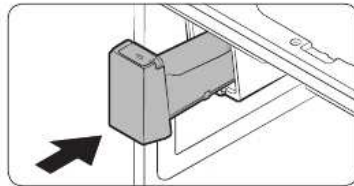
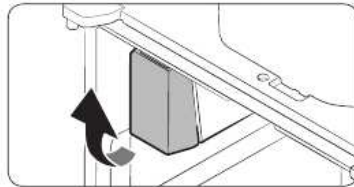

1. To remove the ice bucket, gently lift it up, and then pull it out slowly while holding the bottom of the bucket with one hand and the side with the other hand.
2. Empty the bucket.
3. When done, put the bucket back into position. If the bucket does not fit in, turn the helix screw 90 degrees, and then try again.

CAUTION

- Do not apply excessive force to the bucket cover. The cover may break.
- Do not forcefully close the door. Water may spill over the ice maker.
- To prevent injury, make sure to clean up any ice or water that has fallen on the floor.
- To prevent accidents or injury, do not let children play with the water dispenser or the ice maker.
- Do not put your hand or an object into the ice chute. This may cause physical injury or product damage.
- Use only the provided ice bucket. Third-party ice buckets may cause a system failure.
- Use only potable water that is connected to the water supply line.

NOTE

- The water pressure required for ice making is between 20 psi and 125 psi.
- Noise coming from the ice maker as it produces ice during the ice making process is normal.
- While the door is open, neither the ice maker nor the water dispenser operates.

Tempered glass shelves (fridge)

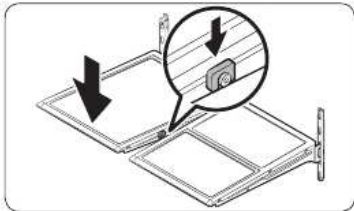
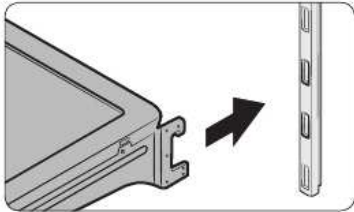
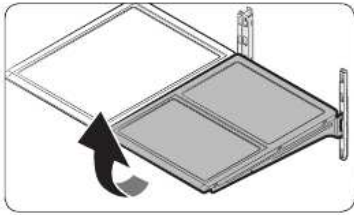

- To remove a shelf, fully open the corresponding door. Hold the front of the shelf, and then gently lift up and slide out.

- To reinsert, hold the shelf at an angle so the front is higher than the back, and then insert the top hook into the top shelf notch. Then, lower the shelf and insert the bottom shelf hook into the bottom shelf notch.

⚠ CAUTION

- The tempered glass shelves are heavy. Use caution when removing them.
- The shelf must be inserted correctly. Do not insert upside down.
- Glass containers may scratch the surface of glass shelves.

Maintenance

Maintenance

Door bins

The top door bin section has a marked line to ensure easy removal and proper reinsertion.

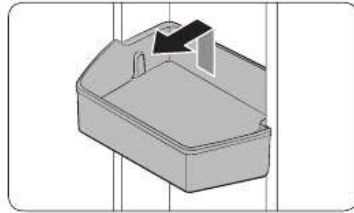

Lift up the door bin, and then pull out straight.

CAUTION

Do not allow children to play with the bins. Sharp-edged corners may cause injury.

Vegetable & fruit drawers (EZ fresh zone)

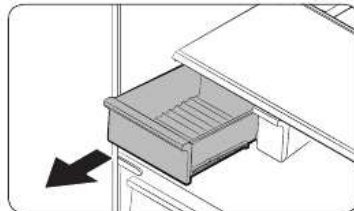

Gently lift up the front of the drawer and slide out.
We recommend that you remove the door bins before removing the drawer. This is to prevent damage to the door bins.

Vegetable shelf

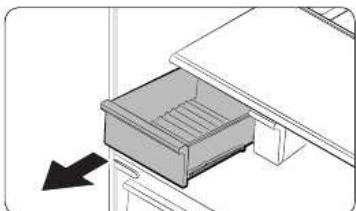

1. Slide out the left-side vegetable drawer.

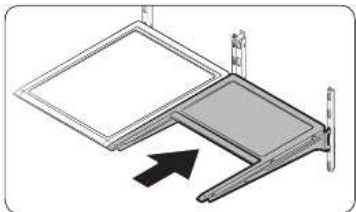

2. Slide in the right-side foldable shelf.

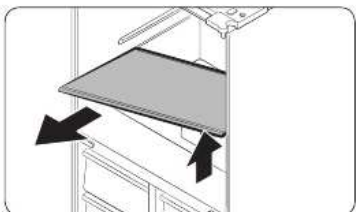

3. While supporting the vegetable shelf with one hand, slide it out with the other hand.

NOTE

To use the space that is opened up after removing the foldable shelf, take out the vegetable shelf.

To reinsert, follow the steps above in the reverse order.

Ice bucket

To remove the ice bucket, see the Maintenance section on page 58.

Maintenance

Cleaning

Interior and exterior

⚠ WARNING

- Do not use benzene, thinner, home/car detergent, or Clorox™ to clean the refrigerator. They may damage the surface of the refrigerator or cause a fire.
- Do not spray water onto the refrigerator. This may cause electric shock.
- Do not put fingers or any objects into the dispenser outlet.

Regularly use a dry cloth to remove all foreign substances such as dust or water from the power plug terminals and contact points.

To clean the refrigerator

1. Unplug the power cord.
2. Use a moistened, soft, lint-free cloth or paper towel to clean the refrigerator's interior and exterior.
3. When done, use a dry cloth or paper towel to dry well.
4. Plug in the power cord.

Inner-view camera

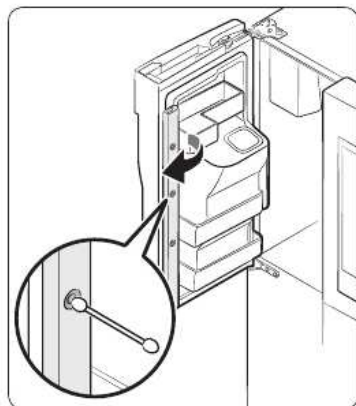

NOTE

Use a cotton swab or microfiber cloth to clean the camera on the left-side door of the fridge.

Replacement

Water filter

WARNING

- Do not use third-party water filters. Use only Samsung-provided or -approved filters.
- Unapproved filters may leak and damage the refrigerator, causing electric shock. Samsung is not responsible for any damage that may occur from use of third-party water filters.

The filter indicator () turns red to let you know it is time to replace the water filter. Before replacing the filter, make sure the water supply line is shut off.

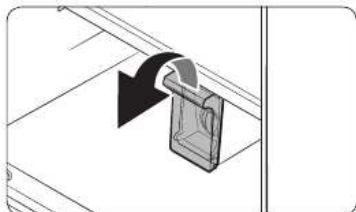

1. Open the filter cover.
 - Some models may not have a filter cover. If your model does not, skip this step.

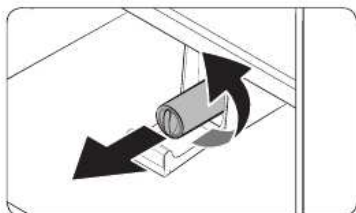

2. Turn the knob of the filter cartridge counter clockwise 90 degrees (1/4 turn). The filter cartridge unlocks.
3. Pull out to remove the cartridge.
 - If the water filter is severely contaminated, the cartridge may not be easy to remove. If that is the case, use force to remove the cartridge.
 - To prevent water leaks from the filter opening, pull the cartridge straight out while removing it.

Maintenance

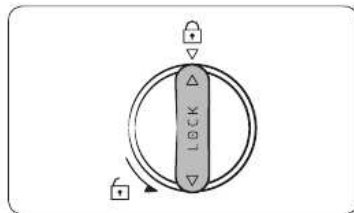
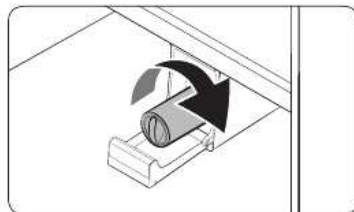
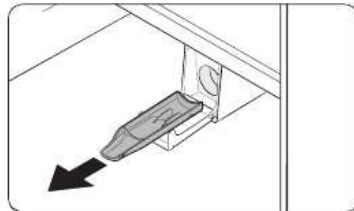

NOTE

To prevent overflow, empty and dry the water filter tray.

4. Insert a new filter cartridge. Use only Samsung-provided or approved filters.

5. Turn the cartridge knob clockwise to lock into place.

6. On the Home screen, tap **Fridge Manager > Fridge Settings > Water Filter**, and then select **RESET**. The filter indicator turns off.

7. When you are done replacing the filter, open the water valve and run water through the dispenser for about 7 minutes. This is to remove impurities and air from the water line.

NOTE

- A newly installed filter may cause the water dispenser to spurt water briefly. This is because air has entered the waterline.
- The replacement process may cause the water dispenser to drip for a short period of time. If it drips, simply wipe up any water on the floor with a dry towel.

Reverse osmosis water filtration system

The water pressure of the water supply system to a reverse osmosis water filtration system must be between 35 psi and 120 psi (241 kPa and 827 kPa).

The water pressure of the reverse osmosis water filtration system to the refrigerator's cold water line must be at least 40 psi (276 kPa). If the water pressure is below these specifications:

- Check if the sediment filter in the reverse osmosis system is blocked. Replace the filter if necessary.
- Refill the water tank in the reverse osmosis system with water.
- If your refrigerator has a water filter, it may further reduce the water pressure when used in conjunction with a reverse osmosis system. Remove the water filter.

For more information or servicing, contact a licensed plumbing professional.

Ordering a new filter

To purchase a new water filter, contact a local Samsung service center or visit www.samsungparts.com on the web.

LED Lights

To replace the LED lights on the refrigerator, contact a local Samsung service center.

WARNING

The LED lights are not user-serviceable. Do not attempt to replace an LED light yourself. This can cause electric shock.

Troubleshooting

Before calling for service, review the checkpoints below. Any service calls regarding normal situations (No Defect Cases) will be charged to users.

General

Temperature

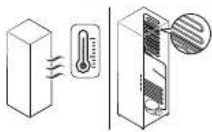
Symptom	Possible causes	Solution
Fridge/freezer does not operate. Fridge/freezer temperature is warm.	• Power cord is not plugged in properly.	• Properly plug in the power cord.
	• Temperature control is not set correctly.	• Set the temperature lower.
	• Refrigerator is located near a heat source or direct sunlight.	• Keep the refrigerator away from direct sunlight or a heat source.
	• Not enough clearance between refrigerator and nearby walls or cabinets.	• Make sure there is a gap of at least 2.5 inches (5 cm) between the refrigerator back and sides and any nearby walls or cabinets.
Fridge/freezer is over-cooling.	• The refrigerator is overloaded. Food is blocking the refrigerator vents.	• Do not overload the refrigerator. Do not allow food to block ventilation.
	• Temperature control is not set correctly.	• Set the temperature higher.
Interior wall is hot.	• Refrigerator has heat-proof piping in the interior wall.	<p>• To prevent condensation from forming, the refrigerator has heat-proof piping in the front corners. If the ambient temperature rises, this equipment may not work effectively. This is not a system failure.</p> 

Odors

Symptom	Possible causes	Solution
Refrigerator has odors.	• Spoiled food.	• Clean the refrigerator and remove any spoiled food.
	• Food with strong odors.	• Make sure strong smelling food is wrapped airtight.

Frost

Symptom	Possible causes	Solution
Frost around the vents.	• Food is blocking the vents.	• Make sure no food blocks the refrigerator vents.
Frost on interior walls.	• Door is not closed properly.	• Make sure food does not block the door. Clean the door gasket.
Fruits or vegetables are frozen.	• Fruits or vegetables are stored in the Flex Zone and the temperature was set too low.	• Set the temperature of the Flex Zone to a temperature appropriate for fruits or vegetables.

Condensation

Symptom	Possible causes	Solution
Condensation forms on the interior walls.	• If door is left open, moisture enters the refrigerator.	• Remove the moisture and do not leave a door open for extended periods of time.
	• Food with high moisture content.	• Make sure food is wrapped airtight.

Troubleshooting

Water/ice (dispenser models only)

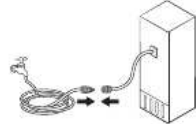
Symptom	Possible causes	Solution
Water flow is weaker than normal.	<ul style="list-style-type: none"> Water pressure is too low. 	<ul style="list-style-type: none"> Make sure the water pressure is between 20 to 120 psi.
Ice maker makes a buzzing sound.	<ul style="list-style-type: none"> The ice maker function is activated, but the water supply to the refrigerator has not been connected. 	<ul style="list-style-type: none"> Press Ice Maker off.
Ice maker does not make ice.	<ul style="list-style-type: none"> Ice maker has just been installed. 	<ul style="list-style-type: none"> You must wait 12 hours for the refrigerator to make ice.
	<ul style="list-style-type: none"> Freezer temperature is too low. 	<ul style="list-style-type: none"> Set the freezer temperature below 0 °F (-18 °C) or -4 °F (-20 °C) in warm, ambient air.
	<ul style="list-style-type: none"> Dispenser Lock is activated. 	<ul style="list-style-type: none"> Deactivate Dispenser Lock.
	<ul style="list-style-type: none"> Ice maker is off. 	<ul style="list-style-type: none"> Turn on the ice maker.
Ice does not dispense.	<ul style="list-style-type: none"> Ice may jam if the ice dispenser is not used for a long time (approx. 3 weeks). 	<ul style="list-style-type: none"> If you won't be using the refrigerator for a long time, empty the ice bucket and turn off the ice maker.
	<ul style="list-style-type: none"> Ice bucket is not properly inserted. 	<ul style="list-style-type: none"> Make sure the ice bucket is properly inserted.
	<ul style="list-style-type: none"> Water line is not connected properly or water supply is not on. 	<ul style="list-style-type: none"> Check if the water line is installed correctly. Check if the water line stop cock is closed. 

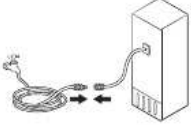
Symptom	Possible causes	Solution
Water does not dispense.	<ul style="list-style-type: none"> Water line is not connected properly or water supply is not on. 	<ul style="list-style-type: none"> Check the water installation conditions. 
	<ul style="list-style-type: none"> Dispenser Lock is activated. 	<ul style="list-style-type: none"> Deactivate Dispenser Lock.
	<ul style="list-style-type: none"> A third-party water filter was installed. 	<ul style="list-style-type: none"> Use only Samsung-provided or approved filters. Unapproved filters may leak and damage the refrigerator.
	<ul style="list-style-type: none"> Water filter indicator turns on or blinks. 	<ul style="list-style-type: none"> Replace the water filter. After replacing, reset the filter indicator sensor.

Troubleshooting

Samsung Smart Home

Symptom	Action
Could not find "Samsung Smart Home" in the app market.	<ul style="list-style-type: none">The Samsung Smart Home app is available for smartphones that run Android 4.0 (ICS) or higher, or iOS 8.0 or higher.
The Samsung Smart Home app fails to operate.	<ul style="list-style-type: none">The Samsung Smart Home app is available for applicable models only.The old Samsung Smart Refrigerator app cannot connect with Samsung Smart Home models.
The Samsung Smart Home app is installed but is not connected to my refrigerator.	<ul style="list-style-type: none">You must log into your Samsung account to use the app.Make sure that your router is operating normally.If you have not connected your refrigerator to the Samsung Smart Home App after the app was installed, you must make the connection using the device registration function of the app.
Could not log into the app.	<ul style="list-style-type: none">You must log into your Samsung account to use the app.If you don't have a Samsung account, follow the app's onscreen instructions to create one.
An error message appears when I try to register my refrigerator.	<ul style="list-style-type: none">Easy Connection may fail due to the distance from your access point (AP) or electrical interference from the surrounding environment. Wait a moment and try again.
The Samsung Smart Home app is successfully connected to my refrigerator but does not run.	<ul style="list-style-type: none">Exit and restart the Samsung Smart Home app or disconnect and reconnect the router.Unplug the power cord of the refrigerator, and then plug it in again after 1 minute.

Samsung Family Hub

Symptom	Action
Could not find "Samsung Family Hub" in the app market.	<ul style="list-style-type: none">The Samsung Family Hub app is available for smartphones that run Android 4.4 (KitKat) or higher, or iOS 8.0 or higher.
Could not log into the app.	<ul style="list-style-type: none">You must log into your Samsung account to use the app.If you don't have a Samsung account, follow the app's onscreen instructions to create one.

Troubleshooting

Smart Grid

Symptom	Action
What Do I Need to use the Energy Management and Smart Grid functions?	<p>To use the Smart Grid (Demand Response) and Energy Management functions on your refrigerator, you need the following:</p> <p>Devices</p> <ul style="list-style-type: none"> • A wireless access point (router) • A Samsung Energy Management-supported refrigerator • A smartphone <p>Registration</p> <ul style="list-style-type: none"> • Connect your refrigerator to your home Wi-Fi network. • Register for the EMS service with your electric company. Your electric company must have an EMS (Energy Management System) supporting SEP (Smart Energy profile). <p>App</p> <ul style="list-style-type: none"> • Download the Samsung Smart Home app from the Google Play Store, Apple App Store, or Samsung Galaxy Apps. • Install and run the Samsung Smart Home app on your smartphone.
Why isn't the Energy Management function working normally?	<ul style="list-style-type: none"> • Make sure that your home router is operating normally with proper Internet service and connection. • Make sure that the refrigerator is connected to the AP (router). <p>Checkpoints</p> <ul style="list-style-type: none"> • Connect your smartphone to the router (AP, Access Point), and then check if you can browse the Internet on the smartphone.
Why isn't the Delay Defrost Capability working normally?	<ul style="list-style-type: none"> • Make sure that your home router is operating normally with proper Internet service and connection.

LCD

Symptom	Action
Cannot connect to my TV.	<ul style="list-style-type: none">• This refrigerator can connect only with Samsung Smart TV 6400 series or higher models released since 2015. Please check the model name of your TV first.• Network connections may suffer temporary interruptions. Turn your TV off, and then try again.
The inner view picture looks bulged out or incomplete.	<ul style="list-style-type: none">• The edges of the inner view may look bulged out. The bulging is caused by the convex lens of the camera.• The inner view may be incomplete due to the blind spots on the left and right corners or screened depending on the layout of food items. Make sure to place food items in the front center.
The displayed measurement on the Fridge Manager is not correct.	<ul style="list-style-type: none">• The displayed conditions may differ from the actual temperature and humidity.

Troubleshooting

Do you hear abnormal sounds from the refrigerator?

Before calling for service, review the checkpoints below. Any service calls related to normal sounds will be charged to the user.

These sounds are normal.

- When starting or ending an operation, the refrigerator may make sounds similar to a car engine ignition. As the operation stabilizes, the sounds will decrease.

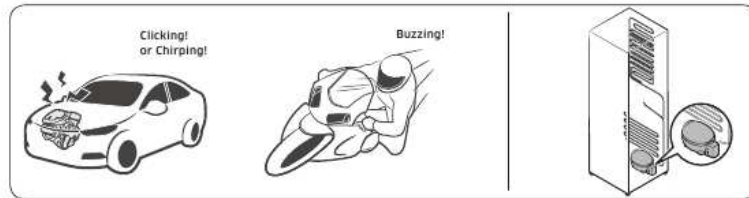

- While the fan is operating, these sounds may occur. When the refrigerator reaches the set temperature, the fan sound will stop.

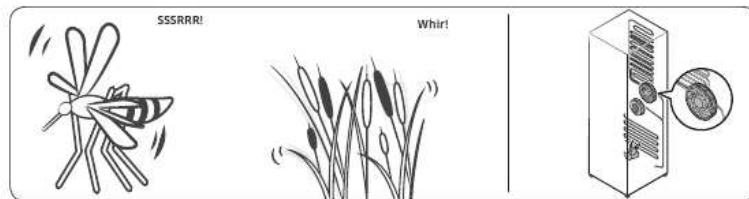

- During a defrost cycle, water may drip on the defrost heater, causing sizzling sounds.

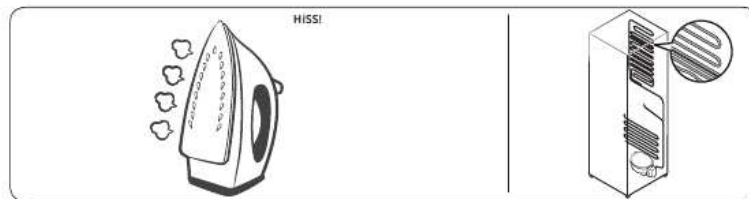

- As the refrigerator cools or freezes, refrigerant gas moves through sealed pipes, causing bubbling sounds.

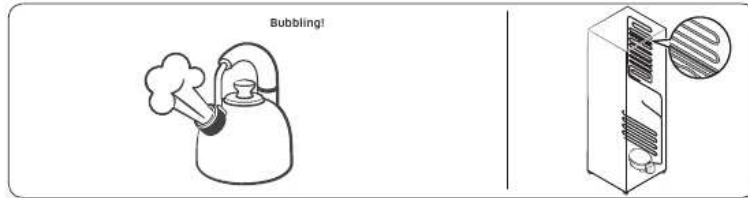

- As the refrigerator temperature increases or decreases, plastic parts contract and expand, creating knocking noises. These noises occur during the defrosting cycle or when electronic parts are working.

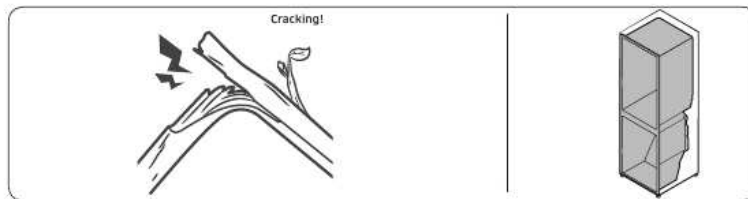

- For ice maker models: When the water valve opens to fill the ice maker, buzzing sounds may occur.
- Due to pressure equalizing when you open and close the refrigerator door, whooshing sounds may occur.

Warranty (USA)

WARRANTY ON SAMSUNG REFRIGERATOR

LIMITED WARRANTY TO ORIGINAL PURCHASER

This Samsung brand product, as supplied and distributed by Samsung Electronics America, Inc. (Samsung) and delivered new, in the original carton to the original consumer purchaser, is warranted by Samsung against manufacturing defects in materials and workmanship for a limited warranty period of:

One (1) year Parts and Labor on Refrigerator

Five (5) years Parts and Labor on sealed Refrigeration system only*

Ten (10) years Parts and Five (5) years Labor on Digital Inverter Compressor

(*Compressor, evaporator, condenser, drier, connecting tubing)

This limited warranty begins on the original date of purchase, and is valid only on products purchased and used in the United States. To receive warranty service, the purchaser must contact Samsung for problem determination and service procedures. Warranty service can only be performed by a Samsung authorized service center. The original dated bill of sale must be presented upon request as proof of purchase to Samsung or Samsung authorized service center.

Samsung will repair or replace any part found to be defective, at our option and at no charge as stipulated herein, with new or reconditioned parts during the limited warranty period specified above. All replaced parts and products become the property of Samsung and must be returned to Samsung. Replacement parts and products assume the remaining original warranty, or ninety (90) days, whichever is longer.

In-home service will be provided during the warranty labor period subject to availability within the contiguous United States. In-home service is not available in all areas. To receive in-home service, the product must be unobstructed and accessible from floor level to service personnel. If during in-home service repair cannot be completed, it may be necessary to remove, repair and return the product. If in-home service is unavailable, Samsung may elect, at our option, to provide for transportation of our choice to and from a Samsung authorized service center. Otherwise, transportation to and from the Samsung authorized service center is the responsibility of the purchaser.

This limited warranty covers manufacturing defects in materials and workmanship encountered in normal, noncommercial use of this product, and shall not apply to the following, including, but not limited to: damage which occurs in shipment; delivery and installation; applications and uses for which this product was not intended; altered product or serial numbers; cosmetic damage or exterior finish; accidents, abuse, neglect, fire, water, lightning or other acts of nature; use of products, equipment, systems, utilities, services, parts, supplies, accessories, applications, installations, repairs, external plumbing and leaks, external wiring, circuit breakers, fuses or connectors not supplied and authorized by Samsung, or which damage this product or result in service problems; incorrect electrical line voltage, fluctuations and surges; customer adjustments and failure to follow operating instructions, cleaning, maintenance and environmental instructions that are covered and prescribed in the instruction book; loss of food due to spoilage; consumable items including filters and light.

THERE ARE NO EXPRESS WARRANTIES OTHER THAN THOSE LISTED AND DESCRIBED ABOVE, AND NO WARRANTIES WHETHER EXPRESS OR IMPLIED, INCLUDING, BUT NOT LIMITED TO, ANY IMPLIED WARRANTIES OF MERCHANTABILITY OR FITNESS FOR A PARTICULAR PURPOSE, SHALL APPLY AFTER THE EXPRESS WARRANTY PERIODS STATED ABOVE, AND NO OTHER EXPRESS WARRANTY OR GUARANTY GIVEN BY ANY PERSON, FIRM OR CORPORATION WITH RESPECT TO THIS PRODUCT SHALL BE BINDING ON SAMSUNG. SAMSUNG SHALL NOT BE LIABLE FOR LOSS OF REVENUE OR PROFITS, FAILURE TO REALIZE SAVINGS OR OTHER BENEFITS, OR ANY OTHER SPECIAL, INCIDENTAL OR CONSEQUENTIAL DAMAGES CAUSED BY THE USE, MISUSE OR INABILITY TO USE THIS PRODUCT, REGARDLESS OF THE LEGAL THEORY ON WHICH THE CLAIM IS BASED, AND EVEN IF SAMSUNG HAS BEEN ADVISED OF THE POSSIBILITY OF SUCH DAMAGES. NOR SHALL RECOVERY OF ANY KIND AGAINST SAMSUNG BE GREATER IN AMOUNT THAN THE PURCHASE PRICE OF THE PRODUCT SOLD BY SAMSUNG AND CAUSING THE ALLEGED DAMAGE. WITHOUT LIMITING THE FOREGOING, PURCHASER ASSUMES ALL RISK AND LIABILITY FOR LOSS, DAMAGE OR INJURY TO PURCHASER AND PURCHASER'S PROPERTY AND TO OTHERS AND THEIR PROPERTY ARISING OUT OF THE USE, MISUSE OR INABILITY TO USE THIS PRODUCT SOLD BY SAMSUNG NOT CAUSED DIRECTLY BY THE NEGLIGENCE OF SAMSUNG. THIS LIMITED WARRANTY SHALL NOT EXTEND TO ANYONE OTHER THAN THE ORIGINAL PURCHASER OF THIS PRODUCT, IS NONTRANSFERABLE AND STATES YOUR EXCLUSIVE REMEDY.

Some states do not allow limitations on how long an implied warranty lasts, or the exclusion or limitation of incidental or consequential damages, so the above limitations or exclusions may not apply to you. This warranty gives you specific legal rights, and you may also have other rights, which vary from state to state. To obtain warranty service, please contact Samsung at:

Warranty (USA)

SAMSUNG CUSTOMER CARE CENTER

Samsung Electronics America, Inc.
85 Challenger Road
Ridgefield Park, NJ 07660
1-800-SAMSUNG (726-7864)
www.samsung.com/us/support