



FlexDry™

User manual

DV*60M9900**

SAMSUNG

Contents

Safety information	4
What you need to know about the safety instructions	4
Important safety symbols	4
Important safety precautions	6
Warnings	8
Cautions	8
Regulatory notice	10
Installation	13
What's included	13
Installation requirements	15
Step-by-step installation	23
Vent blockage test	30
Exhaust ducting guide	31
Door reversal	32
Before you start	35
Sort and load	35
Lint filter	35
Drying guidelines	36
Rack guidelines	37
Operations	39
Delicate Dryer	39
Tumble Dryer	43
Simple steps to start	47
Samsung Smart Home	48
Special features	50
Maintenance	52
General cleaning and maintenance instructions	52
Delicate Dryer	54
Tumble Dryer	55



Troubleshooting	56
Checkpoints	56
Samsung Smart Home	59
Information codes	60
Specifications	62
Fabric care chart	62
Protecting the environment	63
Specification sheet	64
Cycle chart	65



Safety information

Congratulations on your new Samsung dryer. This manual contains important information on the installation, use and care of your appliance. Please take some time to read this manual to take full advantage of your dryer's many benefits and features.

What you need to know about the safety instructions

Please read this manual thoroughly to ensure that you know how to safely and efficiently operate the extensive features and functions of your new appliance. Please store the manual in a safe location close to the appliance for future reference. Use this appliance only for its intended purpose as described in this instruction manual.

Warnings and Important Safety Instructions in this manual do not cover all possible conditions and situations that may occur. It is your responsibility to use common sense, caution and care when installing, maintaining and operating your dryer.

Because the following operating instructions cover various models, the characteristics of your dryer may differ slightly from those described in this manual and not all warning signs may be applicable. If you have any questions or concerns, contact your nearest service center or find help and information online at www.samsung.com.

Important safety symbols

What the icons and signs in this user manual mean:

 **WARNING**

Hazards or unsafe practices that may result in severe personal injury, death and/or property damage.

 **CAUTION**

Hazards or unsafe practices that may result in personal injury and/or property damage.

 **NOTE**

Indicates that a risk of personal injury or material damage exists.

These warning signs are here to prevent injury to yourself and others.

Please follow them explicitly.

After reading this manual, store it in a safe place for future reference.

Read all instructions before using the appliance.

As with any equipment that uses electricity and moving parts, potential hazards exist.

To safely operate this appliance, familiarize yourself with its operation and exercise care when using it.

SAVE THESE INSTRUCTIONS

⚠ WARNING - Gas Appliances:

- **State of California Proposition 65 Warning (US only)**
This product contains chemicals known to the State of California to cause cancer and birth defects or other reproductive harm.
- Gas appliances can cause low-level exposure to Proposition 65 listed substances, including but not limited to, benzene, carbon monoxide, formaldehyde and soot, substances resulting from the incomplete combustion of natural gas or LP fuels.

⚠ WARNING - Risk of Fire

- Clothes dryer installation must be performed by a qualified installer.
- Install the clothes dryer according to the manufacturer's instructions and local codes.
- Do not install a clothes dryer with flexible plastic venting materials. If flexible metal (foil type) duct is installed, it must be of a specific type identified by the appliance manufacturer as suitable for use with clothes dryers. Flexible venting materials are known to collapse, be easily crushed, and trap lint. These conditions will obstruct clothes dryer airflow and increase the risk of fire.
- To reduce the risk of severe injury or death, follow all installation instructions.
- Save these instructions.

Safety Information

SAVE THESE INSTRUCTIONS

Safety information

Important safety precautions

WARNING

To reduce the risk of fire, electric shock, or injury to persons when using your appliance, follow basic precautions, including the following:

1. Read all instructions before using this appliance.
2. Do not dry articles that have been previously cleaned in, washed in, soaked in, or spotted with gasoline, dry-cleaning solvents, or other flammable or explosive substances, as they give off vapors that could ignite or explode.
3. Do not use the dryer to dry clothes which have traces of any flammable substance, such as vegetable oil, cooking oil, machine oil, flammable chemicals, paint thinner, etc., or anything containing wax or chemicals, such as mops and cleaning cloths. Flammable substances may cause the fabric to catch fire by itself.
4. Do not store or use gasoline or other flammable vapors and liquids near this or any other appliance.
5. Do not allow children to play on or in the appliance. Close supervision of children is necessary when the appliance is used near children.
6. Before the appliance is removed from service or discarded, remove the door to the drying compartment.
7. Do not reach into the appliance if the drum is moving.
8. Do not install or store this appliance where it will be exposed to the weather.
9. Do not tamper with internal controls.
10. Do not repair or replace any part of the appliance or attempt any service unless specifically recommended in the user-maintenance instructions or in published user repair instructions that you understand and have the skills to carry out.
11. Do not use fabric softeners or products to eliminate static unless recommended by the manufacturer of the fabric softener or product.
12. Clean the lint screen before or after each load.
13. Do not use heat to dry articles containing foam rubber or similarly textured rubber-like materials.
14. Keep area around the exhaust opening and adjacent surrounding areas free from the accumulation of lint, dust, and dirt.
15. The interior of the appliance and exhaust duct should be cleaned periodically by qualified service personnel.

SAVE THESE INSTRUCTIONS



16. Do not place items exposed to cooking oils in your dryer. Items contaminated with cooking oils may contribute to a chemical reaction that could cause a load to catch fire.
17. This appliance must be grounded. See **Electrical requirements** and **Grounding** in **Installation** section.
18. Do not allow children to play on or in the appliance. Close supervision of children is necessary when the appliance is used near children.
19. Do not insert your hand under the dryer.
 - This may result in injury.
20. Take care that children's fingers are not caught in the door when closing it.
 - This may result in injury.
21. The control board and inlet valve are intentionally not grounded and may present a risk of electric shock only during servicing.
 - Do not contact these parts while the appliance is energized.

⚠ WARNING - To reduce the risk of fire or explosion:

- Do not dry items that have been previously cleaned, washed, soaked, or spotted with gasoline, dry cleaning solvents, or other flammable or explosive substances. They emit vapors that could ignite or explode. Any material that has been in contact with a cleaning solvent or flammable liquids or solids should not be placed in the dryer until all traces of these flammable liquids or solids and their fumes have been removed. There are many highly flammable items used in homes, such as acetone, denatured alcohol, gasoline, kerosene, some liquid household cleaners, some spot removers, turpentine, waxes, and wax removers.
- Items containing foam rubber (which may be labeled latex foam) or similarly textured rubberlike materials must not be dried on a heat setting. Heated foam rubber materials can, under certain circumstances, ignite spontaneously.

SAVE THESE INSTRUCTIONS



Safety information

WARNING - What to do if you smell gas:

- Do not try to light any appliance.
- Do not turn on the appliance.
- Do not touch any electrical switch.
- Do not use any phone in your building.
- Clear the room, building or area of all occupants.
- Immediately call your gas supplier from a neighbor's phone. Follow the gas supplier's instructions.
- If you cannot reach your gas supplier, call the fire department.

Important: Installation and service must be performed by a qualified installer, service agency, or your gas supplier.

Warnings

WARNING

- Ensure pockets are free of small, irregularly shaped hard objects and foreign material, i.e. coins, knives, pins, etc. These objects could damage your dryer.
- Gas leaks may occur in your system, resulting in a dangerous situation.

Cautions

CAUTION

- Do not allow children or pets to play on, in, or in front of the appliance. Close supervision is necessary when the appliance is used near children and pets.
- Before discarding or removing your dryer from service, remove the door to the drying compartment to prevent children or animals from becoming trapped inside.
- Do not reach into the appliance when the drum is moving.
- Do not install or store this appliance where it will be exposed to the weather.
- Do not tamper with the controls.
- Do not repair, replace, or attempt to service any part of the appliance unless specifically instructed to in the user repair instructions and you have the understanding and skills to carry out the procedure.

SAVE THESE INSTRUCTIONS

- Do not use fabric softeners or products to eliminate static unless the softener or product is recommended for dryer use by the manufacturer of the fabric softener or product.
- Clean the lint screen before or after each load.
- Keep the area around the exhaust opening and surrounding areas free from lint, dust, and dirt.
- The interior of the dryer and exhaust duct should be cleaned periodically by qualified service personnel.
- This appliance must be properly grounded. Never plug the power cord into a receptacle that is not grounded adequately or not in accordance with local and national codes. See the installation instructions for information about grounding this appliance.
- Do not sit on top of the dryer.
- Do not dry clothing with large buckles, buttons, or other heavy metal or solid objects.
- Gas leaks may not be detected by smell alone.
- Gas suppliers recommend you purchase and install a UL-approved gas detector.
- Install and use in accordance with the manufacturer's instructions.
- Do not place items in your dryer that have been spotted or soaked with vegetable oil or cooking oil. Even after being washed, these items may contain significant amounts of these oils.
- Residual oil on clothing can ignite spontaneously. The potential for spontaneous combustion increases when items containing vegetable oil or cooking oil are exposed to heat. Heat sources such as your dryer can warm these items, allowing an oxidation reaction in the oil to occur. Oxidation creates heat. If this heat cannot escape, the items can become hot enough to catch fire. Piling, stacking, or storing these kinds of items may prevent heat from escaping and can create a fire hazard.
- All washed and unwashed fabrics that contain vegetable oil or cooking oil can be dangerous.
Washing these items in hot water with extra detergent will reduce, but not eliminate, the hazard. Always use the Cool Down cycle for these items to reduce their temperature. Never remove these items from the dryer hot or interrupt the drying cycle until the items have run through the Cool Down cycle. Never pile or stack these items when they are hot.

SAVE THESE INSTRUCTIONS

Regulatory notice

FCC Notice

CAUTION

Any changes or modifications not expressly approved by the party responsible for compliance could void the user's authority to operate the equipment.

This device complies with Part 15 of FCC Rules. Operation is Subject to following two conditions:

1. This device may not cause harmful interference, and
2. This device must accept any interference received including interference that cause undesired operation.

For products sold in the US and Canadian markets, only channels 1~11 are available. You cannot select any other channels.

FCC STATEMENT:

This equipment has been tested and found to comply within the limits for a Class B digital device, pursuant to part 15 of the FCC Rules. These limits are designed to provide reasonable protection against harmful interference in a residential installation.

This equipment generates, uses, and can radiate radio frequency energy and, if not installed and used in accordance with the instructions, may cause harmful interference to radio communications. However, there is no guarantee that interference will not occur in a particular installation. If this equipment does cause harmful interference to radio or television reception, which can be determined by turning the equipment off and on, the user is encouraged to try to correct the interference by one or more of the following measures:

- Reorienting or relocating the receiving antenna
- Increasing the separation between the equipment and receiver
- Connecting the equipment to an outlet that is on a different circuit than the radio or TV.
- Consulting the dealer or an experienced radio/TV technician for help.

FCC RADIATION EXPOSURE STATEMENT:

This equipment complies with FCC radiation exposure limits set forth for an uncontrolled environment. This equipment should be installed and operated so there is at least 8 inches (20 cm) between the radiator and your body. This device and its antenna(s) must not be colocated or operated in conjunction with any other antenna or transmitter.

IC Notice

The term "IC" before the radio certification number only signifies that Industry Canada technical specifications were met. Operation is subject to the following two conditions:

1. This device may not cause interference, and
2. This device must accept any interference, including interference that may cause undesired operation of the device.

This Class B digital apparatus complies with Canadian ICES-003.

Cet appareil numérique de la classe B est conforme à la norme NMB-003 du Canada.

For products sold in the US and Canadian markets, only channels 1~11 are available. You cannot select any other channels.

IC RADIATION EXPOSURE STATEMENT:

This equipment complies with IC RSS-102 radiation exposure limits set forth for an uncontrolled environment. This equipment should be installed and operated so there is at least 8 inches (20 cm) between the radiator and your body. This device and its antenna(s) must not be colocated or operated in conjunction with any other antenna or transmitter.

Regulatory notice

Regulatory notice

Open Source License Notice

The software included in this product contains open source software. You may obtain the complete corresponding source code for a period of three years after the last shipment of this product by sending an email to <mailto:oss.request@samsung.com>.

It is also possible to obtain the complete corresponding source code in a physical medium such as a CD-ROM; a minimal charge will be required.

The following URL <http://opensource.samsung.com/opensource/SimpleConnectTP/seq/0> leads to the download page of the source code made available and open source license information as related to this product. This offer is valid to anyone in receipt of this information.



Installation

This FlexDry™ dryer must be installed by a qualified technician. The installer is responsible for connecting the dryer to the main power while observing the relevant safety regulations of your area.

What's included

Make sure all the supplied parts and accessories are included in the product package (see page 14). If you have a question about the dryer or the accessories, contact a local Samsung service center or the retailer.

Dryer at a glance

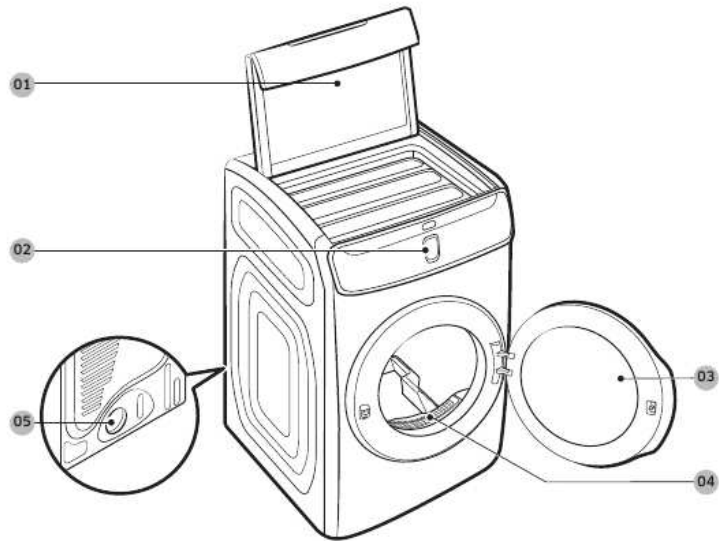

01 Top door

02 Main panel

03 Front door

04 Lint filter

05 Exhaust duct

Installation

Installation

Accessories (supplied)



Y connector



Water hose
(Canadian models only)



Short water hose



Flexible rack



Dryer-sheet case

Accessories (not supplied)

You must purchase these items at a local service center.



Pedestal

⚠ WARNING

Packing materials can be dangerous to children. Keep all packing materials (plastic bags, polystyrene, etc.) out of children's reach.

Tools required (not supplied)



Pliers



Cutting knife



Pipe wrench
(gas models only)



Nut screwdriver



Level



Phillips screwdriver



Duct tape



Wrench

Installation requirements

Read through the following instructions before installing the dryer and keep this manual for future reference.

WARNING

The control board and inlet valve are intentionally not grounded and may present a risk of electric shock only during servicing.

Service personnel: Do not contact these parts while the appliance is energized.

Key installation requirements

- A grounded electrical outlet.
- A power cord for electric dryers (except in Canada).
- Gas lines (for gas models) that must meet national and local regulations.
- An exhaust system made of rigid metal or flexible stiff-walled metal exhaust ducting.

WARNING

Remove the door from all discarded appliances to prevent a child from suffocating.

Location considerations

The dryer should be located where there is enough space at the front for loading the dryer, and enough space behind for the exhaust system. This dryer is factory-ready for the rear exhaust option. To exhaust out the bottom, right or the left, use the accessory exhaust kit. Instructions are included with the kit. Make sure the room in which the dryer is located has enough fresh air. The dryer must be located where there are no air-flow obstructions. For gas dryers, adequate clearance must be maintained as noted on the data plate to ensure adequate air for combustion and proper dryer operation.

The dryer must not be installed or stored in an area where it will be exposed to water and/or weather. The dryer area must be kept clear of combustible materials, gasoline, and other flammable vapors and liquids. A dryer produces combustible lint. The area around the dryer should be kept lint-free.

Installation

Alcove or closet installations

WARNING

- The dryer must be exhausted to the outside to reduce the risk of fire when installed in an alcove or closet.
- No other fuel-burning appliance should be installed in the same closet as the dryer.

Minimum clearances between the dryer and adjacent walls or other surfaces:

Sides	1 in. (25 mm)	Rear	5.9 in. (150 mm)
Top	17 in. (432 mm)	Closet front	2 in. (51 mm)

Installation with pedestal

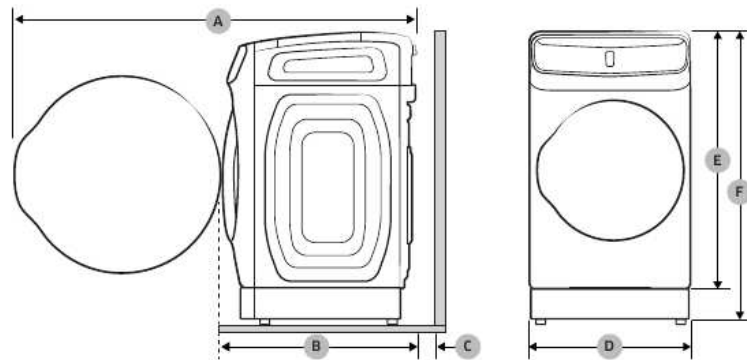

A	53.7 in. (1365 mm)	D	27 in. (686 mm)
B	32.5 in. (825 mm)	E	46.9 in. (1192 mm)
C	5.9 in. (150 mm)	F	52.2 in. (1326 mm)

Installation

Side by side installation

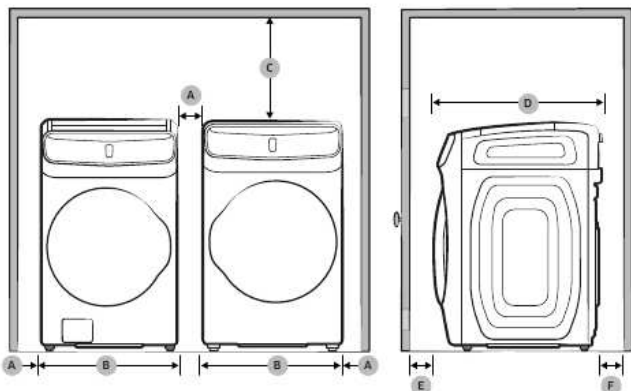

A	1 in. (25 mm)	D	32.5 in. (825 mm)
B	27 in. (686 mm)	E	2 in. (50 mm)
C	35 in. (890 mm)	F	5.9 in. (150 mm)

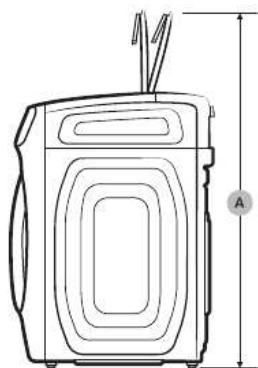

A	61 in. (1550 mm)
----------	------------------

Installation

Installation

Ducting requirements

Weather hood type	Recommended		Use only for short-run installation	
	4" (10.2 cm)		2.5" (6.4 cm)	
No. of 90° elbows	Rigid	Metallic flexible*	Rigid	Metallic flexible*
0	80 ft. (24.4 m)	41 ft. (12.4 m)	74 ft. (22.6 m)	33 ft. (10.1 m)
1	68 ft. (20.7 m)	37 ft. (11.2 m)	62 ft. (18.9 m)	29 ft. (8.8 m)
2	57 ft. (17.4 m)	33 ft. (10.1 m)	51 ft. (15.5 m)	25 ft. (7.6 m)
3	47 ft. (14.3 m)	29 ft. (8.8 m)	41 ft. (12.5 m)	21 ft. (6.5 m)

NOTE

* Use a 4-inch (10.2 cm) diameter rigid aluminum or galvanized steel duct.

If you integrate the dryer's vent system with an existing exhaust system:

- Make sure the exhaust system meets all applicable local, state, and national regulations.
- Verify you are not using flexible plastic duct.
- Make sure to check for and remove all lint buildup from inside the existing ducts.
- Confirm the duct is not kinked or crushed.
- Make sure the exhaust hood damper opens and closes freely.

Manometer measurements

The static pressure in any exhaust system must not exceed 0.83 inches of water column or be less than 0. Note that these values are measured with the dryer running with a manometer presented to the exhaust duct that connects to the dryer. The dryer drum must be empty and lint filter clean.

Exhausting requirements

The dryer must not be exhausted into a chimney, a wall, a ceiling, an attic, a crawl space, or a concealed space of a building. Exhausting the dryer to the outside will prevent large amounts of lint and moisture from being blown into the room.

In the United States and Canada

- All dryers must be exhausted to the outside.
- The required exhaust duct is 4 inches (10.2 cm) in diameter.
- See **Ducting requirements** in the **Installation** section for the maximum duct length and number of bends that can be used.
- The total length of flexible metal duct must not exceed 7' 10½" (2.4 m).
- Do not assemble the duct with screws or other fasteners that extend into the duct and catch lint.
- **For the United States only:** Use only those foil-type flexible ducts, if any, specifically identified for use with the appliance by the manufacturer and that comply with the Outline for Clothes Dryer Transition Duct. Use Subject 2158A.

Outside the United States and Canada

- Refer to the local codes.

WARNING

- You must exhaust the dryer to the outside to reduce the risk of fire when you install the dryer in an alcove or closet.
- Do not use a plastic or non-metal flexible duct.
- If your existing ductwork is plastic, non-metal, or combustible, replace it with metal.
- Use only a metal exhaust duct that is non-flammable to ensure containment of exhaust air, heat, and lint.

Installation

Installation

Gas requirements

WARNING

- Use only natural or LP (liquid propane) gases.
- THE INSTALLATION MUST CONFORM WITH LOCAL CODES, OR IN THE ABSENCE OF LOCAL CODES, WITH THE NATIONAL FUEL GAS CODE ANSI/ Z223.1, LATEST REVISION (FOR THE UNITED STATES), OR WITH THE CAN / CGA-B149 INSTALLATION CODES (FOR CANADA).
- Gas dryers are equipped with a burner vent for use with natural gas. If you plan to use your dryer with LP (liquid propane) gas, it must be converted for safe and proper performance by a qualified service technician.
- A 1/2" (1.27 cm) gas supply line is recommended and must be reduced to connect to the 3/8" (1 cm) gas line on your dryer. The National Fuel Gas Code requires that an accessible, approved manual gas shut-off valve be installed within 6" of your dryer.
- Gas dryers installed in residential garages must be raised 18 inches (46 cm) above the floor.
- Additionally, a 1/8" (0.3 cm) N.P.T. (National Pipe Thread) plugged tapping, accessible for test gauge connection, must be installed immediately upstream of your dryer's gas supply connection.
- Your dryer must be disconnected from the gas supply pipe system during any pressure testing of the system.

- Do not reuse old flexible metal gas lines. Flexible gas lines must be design certified by the American Gas Association (CGA in Canada).

NOTE

- Your dryer uses an automatic ignition system to ignite the burner. There is no constant burning pilot.
- Any pipe joint compound used must be resistant to the action of any liquefied petroleum gas.
- As a courtesy, most local gas utilities will inspect a gas appliance installation.

Commonwealth of Massachusetts installation instructions

Your dryer must be installed by a licensed plumber or gas fitter. A "T" handle manual gas valve must be installed in the gas supply line to your dryer. If a flexible gas connector is used to install your dryer, the connector can be no longer than 3' (36").

WARNING

- Gas leaks may occur in your system, creating a dangerous situation.
- Gas leaks may not be detected by smell alone.
- Gas suppliers recommend you purchase and install a UL-approved gas detector.
- Install and use in accordance with the manufacturer's instructions.

Electrical requirements

The wiring diagram is located on the plate under the control panel or rear frame.

WARNING

- Improperly connecting the equipment grounding conductor can result in a risk of electric shock. Check with a qualified electrician or serviceman if you are in doubt as to whether your dryer is properly grounded. Do not modify the plug provided with your dryer – if it doesn't fit the outlet, have a proper outlet installed by a qualified electrician.
- To prevent unnecessary risk of fire, electrical shock, or personal injury, all wiring and grounding must be done in accordance with local codes, or in the absence of local codes, in accordance with the National Electrical Code, ANSI/NFPA No. 70-Latest Revision (for the U.S.) or the Canadian Electrical Code CSA C22.1 – Latest Revisions and local codes and ordinances. It is your responsibility to provide adequate electrical service for your dryer.
- All gas installations must be done in accordance with the national Fuel Code ANSI/Z2231 – Latest Revision (for the U.S.) or CAN/CGA – B149 Installation Codes – Latest Revision (for Canada) and local codes and ordinances.

Grounding

This dryer must be grounded. In the event of a malfunction or breakdown, the ground will reduce the risk of electrical shock by providing a path of least resistance for the electrical current.

Gas models

WARNING

- Your dryer has a cord with an equipment-grounding conductor and a grounding plug. The plug must be plugged into an appropriate outlet that is properly installed and grounded in accordance with all local codes and ordinances.
- Do not modify the plug provided with your dryer – if it doesn't fit the outlet, have a proper outlet installed by a qualified electrician.
- Do not connect the ground wire to plastic plumbing lines, gas lines, or hot water pipes.

Electric models

WARNING

- Your dryer has an optional cord with an equipment-grounding conductor and a grounding plug. This cord is sold separately.
- The plug must be plugged into an appropriate outlet that is properly installed and grounded in accordance with all local codes and ordinances.
- Do not modify the plug provided with your dryer – if it doesn't fit the outlet, have a proper outlet installed by a qualified electrician.

Installation

- If a power cord is not used and the electric dryer is to be permanently wired, the dryer must be connected to a permanently grounded metal wiring system, or an equipment grounding conductor must be run with the circuit conductors and connected to the equipment grounding terminal or lead on the dryer.

Electrical connections

Before operating or testing, follow all grounding instructions in the **Grounding** section. An individual branch (or separate) circuit serving only your dryer is recommended.

Do not use an extension cord.

Gas models - U.S. and Canada

A 120 volt, 60 Hz AC approved electrical service with a 15-ampere fuse or circuit breaker is required.

Electric models - U.S. only

Most U.S. dryers require a 120 / 240 volt, 60 Hz AC approved electrical service. Some require 120 / 208 volt, 60 Hz approved electrical service. The electric service requirements can be found on the data label located behind the door. A 30-ampere fuse or circuit breaker on both sides of the line is required.

- If a power cord is used, the cord should be plugged into a 30-ampere receptacle.
- The power cord is not provided with U.S. electric model dryers. This cord is sold separately.

WARNING

Risk of Electric Shock

When local codes allow, you can connect the dryer's electrical supply with a new power supply cord kit, marked for use with a dryer, that is U.L. listed and rated at a minimum of 120 / 240 volts, 30-amperes with three No. 10 copper wire conductors terminated with closed loop terminals, open-end spade lugs with turned up ends, or with tinned leads.

- Do not reuse a power supply cord from an old dryer. The power cord electric supply wiring must be supported at the dryer cabinet by a suitable UL-listed strain relief.
- Grounding through the neutral conductor is prohibited for (1) new branch-circuit installations, (2) mobile homes, (3) recreational vehicles, and (4) areas where local codes prohibit grounding through the neutral conductor. (Use a 4-prong plug for a 4 wire receptacle, NEMA type 14-30R.)

Electric models - Canada Only

- A 120 / 240 volt, 60 Hz AC approved electrical service fused through a 30-ampere fuse or circuit breaker on both sides of the line is required.
- All Canadian models are shipped with the power cord attached. The power cord should be plugged into a 30-ampere receptacle.

NOTE

In Canada, you may not convert a dryer to 208 volts.



Step-by-step installation

Make sure you have a qualified technician install the dryer. Step by step installation instructions start below.

STEP 1 Install the exhaust system

1. Select a location and move the dryer to the site. For easy access, we recommend you install the dryer in the same location as your washer.
2. To change the door direction, see **Door reversal**.
3. Install the exhaust system as instructed in the **Exhaust ducting guide** section.

NOTE

- To move the dryer easily, lay two of the carton cushions from the packaging on the floor. Tip the dryer on its side so it lies across both cushion-tops. Push the dryer so that it is near its final location, and then set the dryer upright.
- Secure room around the dryer to facilitate ducting and wiring.

STEP 2 Connect the gas line

First, read through the **Gas requirements** section, and follow these steps.

1. Remove the protective cap from the gas pipe.
2. Apply a LPG (Liquefied Petroleum Gas)-safe compound or 1.5 wraps of Teflon tape to all threaded connections.
3. Connect the gas supply to the dryer. An additional fitting is required to connect the 3/4" (1.9 cm) female thread end of a flexible connector to the 3/8" (1 cm) male threaded end on the dryer. Tighten up the fitting over all threads.
4. Turn on the gas supply, and check for any leaks using a soap solution. If a leak is found, tighten the connections and try again. **DO NOT** use an open flame to check for gas leaks.

Installation

STEP 3 Connect the electrical wiring

First, read through the **Electrical requirements** section, and then follow these steps.

3-wire system

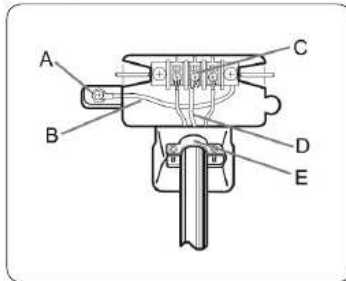

- A. External ground connector
- B. Neutral grounding wire (white)
- C. Center silver-colored terminal block screw
- D. Neutral wire (white or center wire)
- E. $\frac{3}{4}$ " (1.9 cm) UL-listed strain relief

1. Loosen or remove the center terminal block.
2. Connect the neutral wire (white or center wire) of the power cable to the center, silver-colored terminal screw of the terminal block. Tighten the screws.
3. Connect the other wires to outer terminal block screws. Tighten the screws.
4. Tighten the strain relief screws.
5. Insert the terminal block cover into the rear panel of the dryer. Then, secure the cover with a hold-down screw.

CAUTION

- To convert from the 4-wire system to 3-wire system, connect the ground strap to the terminal block support to ground the dryer frame to the neutral conductor.
- Ring-type terminals are recommended. If using strap terminals, make sure they are tightened.

4-wire system

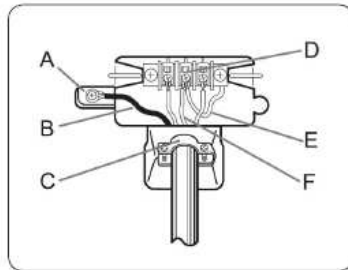

- A. External ground connector
- B. Green or bare copper wire of power cord
- C. $\frac{3}{4}$ " (1.9 cm) UL-listed strain relief
- D. Center silver-colored terminal block screw
- E. Neutral grounding wire (white)
- F. Neutral wire (white or center wire)

1. Remove the external ground connector's screw, and connect the ground wire (green or unwrapped) of the power cable to the screw.

⚠ CAUTION

- To connect the ground wire to the neutral position without through contact A (cabinet ground), contact a technician. This is not user serviceable.
 - Ring-type terminals are recommended. If using strap terminals, make sure they are tightened.
2. Loosen or remove the screws from the center terminal block.
 3. Connect the neutral wire (white or center wire) and ground wire (white) to the center screw of the terminal block. Tighten the screw.
 4. Connect the other wires to the outer terminal block screws. Tighten the screws.
 5. Tighten the strain relief screws.
 6. Insert the tab of the terminal block cover into the rear slot of the dryer. Secure the cover with a hold-down screw.

⚠ WARNING

- All U.S. models are designed for a 3-wire system connection. The dryer frame is grounded to the neutral conductor at the terminal block. A 4-wire system connection is required for new or remodeled construction, mobile homes, or if local codes do not permit grounding through neutral. If you use the 4-wire system, you cannot ground the dryer frame to the neutral conductor at the terminal block.
- Remove the terminal block cover plate. Insert the power cord with a UL-listed strain relief through the hole provided in the cabinet near the terminal block.

Installation

- A strain relief must be used. Do not loosen the nuts already installed on the terminal block. Be sure they are tight. Use a 3/8" (1 cm) deep well socket.

STEP 4 Connect the water hose (applicable models only)

The dryer must be connected to a cold water tap using the provided water hoses.

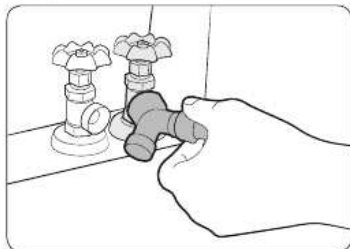

1. Close the cold water tap. If you have a washer cold water hose attached to the cold water faucet, unscrew and remove the hose. Then, connect the female end of the Y connector to the cold water tap.
2. Connect the straight end of the water hose to the Y connector. Tighten the hose coupling by hand.
3. Using pliers, tighten the coupling an additional two-thirds turn. Do not overtighten. You can damage the coupling.
4. Connect the angled end of the water hose to the filling valve at the bottom rear of the dryer. Turn the coupling by hand until it is tight.
5. Using pliers, tighten the coupling an additional two-thirds turn. Do not overtighten. You can damage the coupling.
6. If you detached the cold water hose from your washer, attach the hose to the open end of the Y connector, tighten the coupling by hand until it is tight, and then, using a pliers, tighten an additional two-thirds turn.
7. Open the cold water tap, and then check for any leaks.

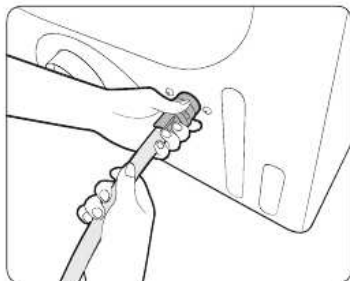

If the Y connector cannot be directly connected to the cold water tap, use the short hose as shown on the following page.

Using the short hose as an extension

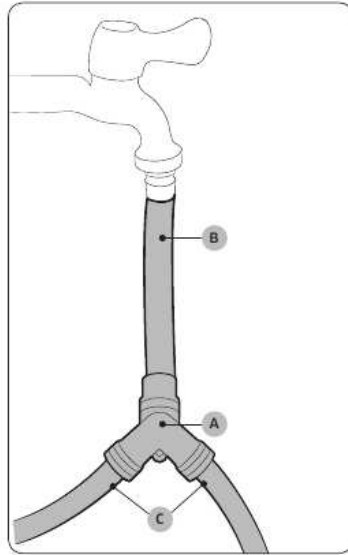

1. Close the cold water tap. If you have a washer cold water hose attached to the cold water faucet, unscrew and remove the hose. Then, connect the **short hose (B)** to the cold water tap. Turn the coupling by hand until it is tight.
2. Using pliers, tighten the coupling an additional two-thirds turn. Do not overtighten. You can damage the coupling.
3. Connect the **Y connector (A)** to the brass male end of the short hose. Turn the coupling by hand until it is tight.
4. Using pliers, tighten the coupling an additional two-thirds turn. Do not overtighten. You can damage the coupling.
5. Connect the angled end of the **water hoses (C)** to the filling valve at the bottom rear of the dryer. Turn the coupling by hand until it is tight.
6. Using pliers, tighten the coupling an additional two-thirds turn. Do not overtighten. You can damage the coupling.
7. If you detached the cold water hose from your washer, attach the hose to the free end of the Y connector, tighten the coupling by hand until it is tight, and then, using a pliers, tighten an additional two-thirds turn.
8. Open the cold water tap, and then check for any leaks.

Installation

STEP 5 Level the dryer

To ensure optimal performance, the dryer must be level.

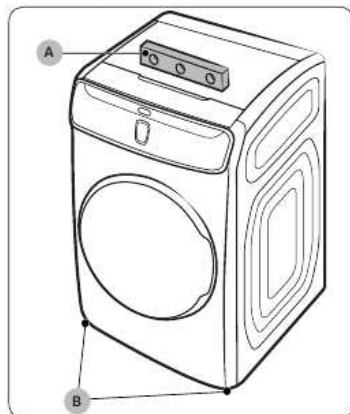

1. Using a **level (A)**, check if the dryer is level side to side and then front to back. If the dryer is not level, adjust the **leveling feet (B)** at the bottom of the dryer. Then, check if the dryer is level again.

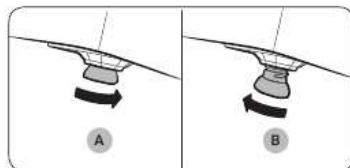

NOTE

- To set the dryer to the same height as your washer, fully **retract (A)** the leveling feet by turning them counterclockwise, then **loosen (B)** the feet by turning them clockwise. Once the dryer is the same height as the washer, follow the directions above to level the dryer.
- Adjust the leveling feet only as much as necessary to level the dryer. Extending the leveling feet more than necessary can cause the dryer to vibrate.



STEP 6 Power on (Gas models)

Make sure all gas connections, the exhaust line, and all wiring is connected correctly. Then, plug the power cord into a power source and check the dryer's installation and operation using the final checklist in Step 7 below.

STEP 7 Final check

When installation is complete, confirm that:

- The dryer is plugged into an electrical outlet and grounded properly.
- The exhaust ductwork is connected and the joints are taped.
- You have used rigid or stiff-walled flexible metal duct material, not plastic flexible duct.
- The dryer is level and is sitting firmly on the floor.
- The dryer starts, runs, heats, and shuts off properly.

For gas models:

- Gas is supplied properly with no leaks.

CAUTION

The burner may not ignite initially due to air in the gas line. Allowing your dryer to operate on a heat setting will purge the line. If the gas does not ignite within 5 minutes, turn your dryer off and wait 5 minutes. Be sure the gas supply to your dryer has been turned on. To confirm gas ignition, check the exhaust for heat.

Installation

Installation

Vent blockage test

After the dryer is installed, start the Vent Blockage Test to check if the duct system is properly installed. The Vent Blockage Test automatically detects the status of the ducts and reports any blockage or problems. Proper ducting can reduce drying time and save energy.

NOTE

The Vent Blockage Test must run with the dryer in a cool state. If the dryer warms up after the installation check, run the AIR FLUFF cycle for several minutes to reduce its internal temperature.

Running the vent blockage test

1. Make sure the drum is empty, and then close the door.
(If there are any clothes or other items in the drum, the test will not give accurate results.)
2. Press **POWER** to turn the dryer on, then simultaneously press and hold the **Adjust Time**  and **Dry level** buttons for 3 seconds. "InS" appears in the dryer's display. (If you have started other procedures before the Vent Blockage Test, the dryer will not enter the Vent Blockage Test mode.)
3. Press and hold **START/PAUSE**. The Vent Blockage Test starts immediately. During the test, the number indicator makes a circle in 6 clockwise steps. The test takes about 2 minutes. Do not open the door during the test.
4. After 2 minutes, when the test is complete, the results is displayed and the dryer sounds a tone.
If status of the duct system is normal, "0" appears and the dryer sounds a completion tone.
If the duct system can not exhaust properly, "CLg" appears and the dryer sounds an alarm tone.
If there are any other problems, an information code appears in the display. For information about the code, see **Information codes** section on page 60.
 - To stop or cancel the Vent Blockage Test, press **POWER** to turn off your dryer.
 - During the test, if "dc" appears in the display, make sure the door is closed. If "C1" is displayed, see if there is laundry inside drum. If there is, stop the test and remove it. Then, start the test again.
 - The results remain on the display for about 5 minutes and then automatically turn off. You can turn the result off immediately by pressing **POWER**.

NOTE

- During or after the test, the internal drum is hot. Use caution to prevent burns. The Vent Blockage Test is used to check for problems to the current duct system when the dryer is installed for the first time.
- If the test result displays "CLg" (the duct system is blocked), refer to the **Ducting requirements** section on page 18 and the **Exhaust ducting guide** section below, and then take proper measures to correct any problems. If the test is suspended, it could result in incorrect results. Follow the proper procedures when testing the dryer.
- Even if the test result is normal ("0"), the duct system could be blocked slightly. Properly install all duct work according to the installation instructions in this manual.

Exhaust ducting guide

Ducting

1. Make sure the dryer is installed properly so the air exhausts freely.
2. Use 4-inch rigid metal ducts. Tape all joints including the dryer connection. Never use lint-trapping screws.
3. To facilitate the exhaust, keep the ducts as straight as possible.

Cleaning

Clean all old ducts before installing the dryer, and make sure the vent flap opens and closes freely. We recommend that you clean the exhaust system annually or on a regular basis.

WARNING

- To prevent fire, do not use plastic, thin-foil, or non-metal flexible ducts of any kind.
- Do not use a poor exhaust system because it slows down the dryer's performance.
- Do not use excessively long ducts that have multiple elbows.
- Do not use crushed or clogged venting or ducts.

Installation

Door reversal

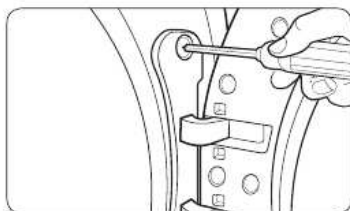

1. Unplug the power cord.
2. Remove two door hinge screws.
3. Lift the door and remove it.

NOTE

There is a screw on the back side of the hinge that will support the door as you unscrew the hinge screws.



4. Remove the two screws that are above and below the cut-out in the frame front.



5. Remove the two screws above and below the lever holder on the opposite side of the door opening.

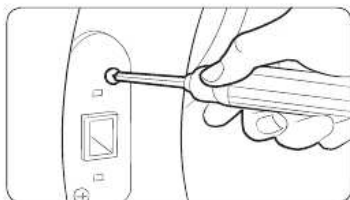

6. Remove the two screws that hold the lever holder in place, and then remove the lever holder.



7. Re-insert the two screws that held the lever holder into the same screw holes, and then tighten.

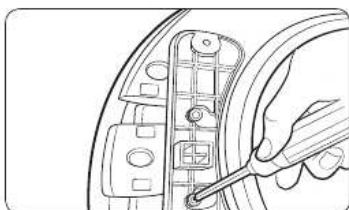

8. Remove the single screw from the back of the door hinge.

NOTE

This is the screw that supports the door against the frame so you can unscrew or screw in the hinge without needing to support the door yourself.

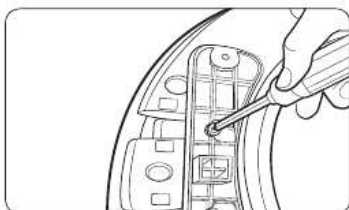

9. Insert the screw you just removed into the other screw hole on the back of the door hinge, and then tighten.

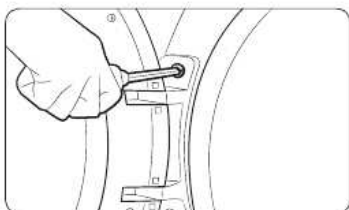

10. Place the door on the other side, and then reattach it to the dryer.

NOTE

Insert the head of the screw on the back of the hinge into the hole above the cut out in the frame, and then slide the door hinge down until it stops. Make sure the protrusion on the back of the hinge is pressed into the cut out before you tighten the hinge screws.

Installation

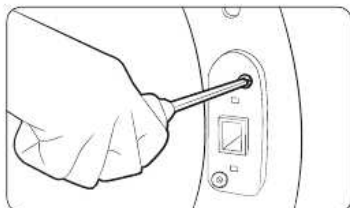

11. Push the lever holder into the cut out on the other side of the door opening. Insert screws, and then tighten as shown.

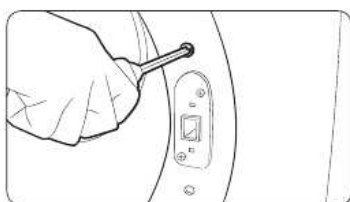

12. Re-attach the remaining screws to the remaining holes above and below the lever holder, and then tighten.

Before you start

Here are a few things you should know before starting your dryer.

Sort and load

- Put one wash load in the dryer at a time.
- Do not mix heavy and lightweight items together.
- To improve drying efficiency for one or two items, add a dry towel to the load.
- For best results, untangle items before inserting them into the dryer.
- Overloading causes uneven drying and wrinkling.
- Unless recommended on the care label, do not dry woolens or fiberglass items.
- Avoid drying unwashed items.
- Do not dry items soiled with oil, alcohol, gasoline, or other flammable materials.

Lint filter

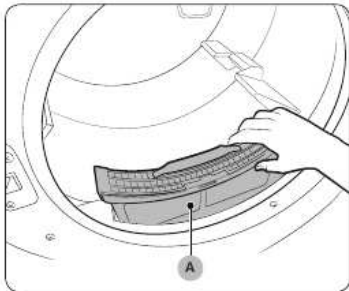

To prevent a risk of fire, make sure to clean the lint filter before or after every load.

1. Turn the dryer off.
2. Open the door, and then pull out the **lint filter (A)** from inside the drum.
3. Open the lint filter by separating it at the top. Remove the lint and any other debris that has accumulated in the filter.
4. Close the lint filter, reinsert the lint filter into the dryer, and then close the dryer door.

CAUTION

- Do not operate the dryer without the lint filter in place.
- Do not use a damaged or broken lint filter. This may reduce performance and/or cause a fire.

Before you start

Before you start

Drying guidelines

The best way to dry items is to follow the instructions on the care label. If no drying instructions are provided, see the following table for reference.

Cycle	Description
Bedspreads & Comforters	Follow the care label instructions or dry using NORMAL. <ul style="list-style-type: none">• Make sure the item is thoroughly dry before using or storing.• May require repositioning in the drum to ensure even drying.
Blankets	Use NORMAL and dry only one blanket at a time for best tumbling action. <ul style="list-style-type: none">• Make sure blankets are thoroughly dry before using or storing.
Curtains & Draperies	Use PERM PRESS and the Medium temperature setting to help minimize wrinkling. <ul style="list-style-type: none">• Dry curtains and draperies in small loads for best results and remove as soon as possible after the cycle is complete.
Cloth Diapers	Use NORMAL and the Medium temperature setting for soft, fluffy diapers.
Down-filled Items (jackets, sleeping bags, comforters, etc.)	Use NORMAL and the Medium temperature setting. <ul style="list-style-type: none">• Add a couple of dry towels to absorb moisture and shorten drying time.
Foam Rubber (rug backs, stuffed toys, shoulder pads, etc.)	Do not dry on a heat setting. Use AIR FLUFF. ⚠ WARNING Drying a rubber item with heat may damage it or cause a fire.
Pillows	Use NORMAL. <ul style="list-style-type: none">• Add a couple of dry towels and a pair of clean sneakers to help the tumbling action and to fluff the pillows.• Do not dry kapok or foam pillows using a heated drying cycle. You can dry these items in the dryer only if you use AIR FLUFF.
Plastics (shower curtains, outdoor furniture covers, etc.)	Use AIR FLUFF or TIME DRY and the Low or Extra Low temperature settings depending on the care label instructions.

Before you start

⚠ WARNING

Do not dry:

- Fiberglass items (curtains, draperies, etc.)
- Wool, silk items, unless recommended on the label
- Items spotted or soaked with vegetable or cooking oils

Rack guidelines

Flexible rack

The flexible rack is designed to dry delicate items that are not suitable for or cannot be dried in the Tumble Dryer.

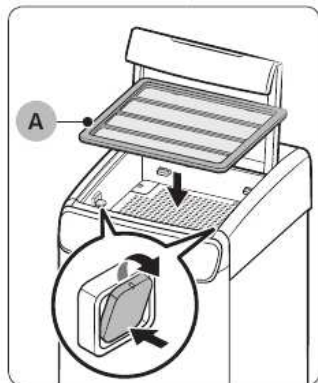

To use the flexible rack

1. Locate the rack supports (x4) in each corner of the Delicate Dryer. Push down the lower area of the front 2 supports to unfold. The rear 2 supports are fixed.
2. Insert the **flexible rack (A)** inside the Delicate Dryer. Make sure all 4 corners of the rack sit on the rack supports properly.

NOTE

You don't have to use the drying rack. Put bulky items below the rack and put any additional items on the rack.

Before you start

Before you start

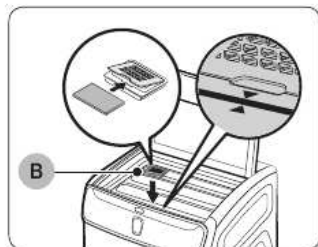

3. Insert a folded dryer sheet in **dryer-sheet case (B)**, and then put the case at the top center of the rack. Make sure the dryer-sheet case faces against the triangle mark on the Delicate Dryer because only the arrow area has the built-in magnet to secure the filter.

NOTE

If using a large-sized dryer sheet, the dryer-sheet case may not close normally. However, this does not affect the drying performance.

Bulky items are easily wrinkled in the Delicate Dryer. Do not dry bulky items in the Delicate Dryer. Please see the Recommended for the Delicate Dryer section for reference.

WARNING

Do not dry animals, plants, food items, or anything else but clothing.



Operations

This FlexDry™ dryer features the Delicate Dryer and the Tumble Dryer for your convenience. The Delicate Dryer is a top load dryer that is designed to dry relatively small loads while the Tumble Dryer is a drum loader you can use to dry normal or relatively heavy loads. The main panel is divided into 2 independent control panels.

⚠ WARNING

To reduce the risk of fire, electric shock, or injury, read the Safety information section before operating this dryer.

⚠ CAUTION

Do not spray water onto the main panel. This may cause a system failure.

Delicate Dryer

Control panel

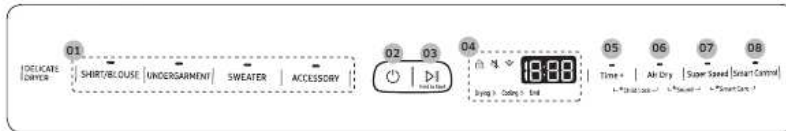

01 Cycle bar	Press to select a cycle.
02 POWER	Press to turn the Delicate Dryer on or off.
03 START/PAUSE (Hold to Start)	Press and hold to start operation, or press to stop operation temporarily.
04 Status bar	The status bar shows current cycle information and estimated time remaining or an information code if the Delicate Dryer needs to be checked.
05 Time+	Press to increase the drying time in 20-minute increments. You can adjust the drying time up to 100 minutes according to the type and amount of the clothing.
06 Air Dry	You can dry heat-sensitive clothing without heat, in room temperature air. Such clothing may require more time to dry. To extend the drying time, use Time+. This option is for the "shirt/blouse", "undergarment" and "accessory" cycle.
07 Super Speed	Super Speed increases the fan speed to shorten the drying time. This option is for the "shirt/blouse", "undergarment" and "accessory" cycle.

Operations

Operations

08 Smart Control (Elec.) / Smart Monitor (Gas)	Press to turn the Smart Control function on or off. You can control or monitor the dryer remotely. When started, the Smart Control (Smart Monitor) indicator blinks. For details, see the Samsung Smart Home section later in this manual.
---	--

Cycle overview





Cycle	Description
SHIRT/BLOUSE	• For synthetic blouses and blouses with accessories (ornaments)
UNDERGARMENT	• For synthetic reshaping innerwear, innerwear with laces, spandex fabrics for Pilates or Yoga, and leggings
SWEATER	• For washable wool or wool-blended sweaters, cotton or cotton-blended sweaters, and knitted cardigans
ACCESSORY	• For scarfs, mufflers, gloves, and stockings

NOTE

- Make sure you input items appropriate to the selected cycle. Overloads may delay the drying time. To extend the drying time, use Time+.
- Stretch out the items as straight as possible. Overlapping items may not dry well.
- Use the Tumble Dryer for blue jeans, thick clothing, or towels.
- The drying time may depend on the load conditions. To shorten, use a higher spinning speed.
- For manual-wash items, use a towel to remove moisture from the items before drying.

Recommended for the Delicate Dryer

- The drying time depends on the load and the item type. To shorten the drying time, use **Super Speed**.
- Overloads may delay the drying time. To extend the drying time, use **Time+**.
- For manual-wash items, use a towel to remove moisture from the items before drying.
- For machine-washable items, you can reduce the drying time by choosing a higher spinning rate.
- Arrange items as even and straight as possible. Overlapped items may not be dried well. Available or recommended items for a specific cycle are as below:

Cycle	Picture	Load	Item
SWEATER		1 EA (max. 2 EA)	Wool or wool-blended sweaters, cotton or cotton-blended sweaters, knitted cardigans
SHIRT/BLOUSE		1 EA (max. 2 EA)	Synthetic blouses, blouses with accessories (ornaments)
UNDERGARMENT		3 EA (max. 6 EA)	Synthetic reshaping innerwear, innerwear with laces, spandex fabrics for Pilates or Yoga, leggings
ACCESSORY		2 EA (max. 4 EA)	Scarfs, mufflers, gloves, stockings

The max load is calculated on the condition of using the drying rack.

Operations

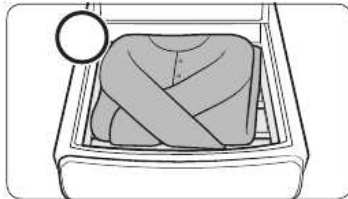

⚠ Caution

Clothing with accessories or hooks may get stuck in the mesh of the rack.

- Clothing with accessories must face upwards.
- Clothing with hooks must be hooked up before being placed.

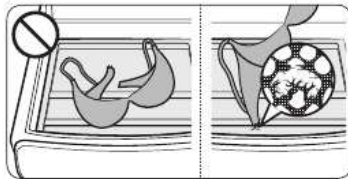
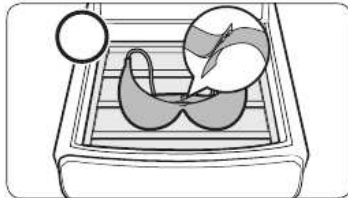

Not Recommended for the Delicate Dryer



Do not dry shoes, bags, down/fur products, rugs, carpets, or bulky items in the Delicate Dryer.

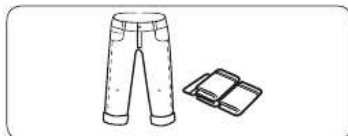

Use the Tumble Dryer for normal items (ex: blue jeans, bulky cotton items, towels, etc.)

Tumble Dryer

Control panel

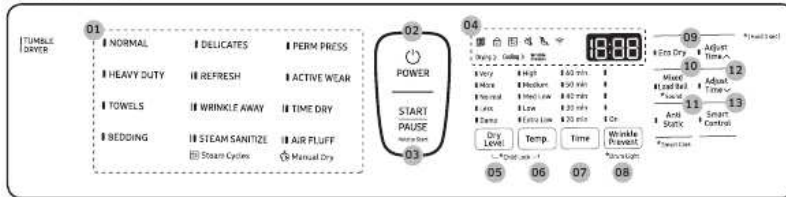

01 Cycle area	<p>Press a cycle name to select a cycle.</p> <ul style="list-style-type: none"> • Sensor Dry cycles: The dryer senses its internal humidity and shuts off when the internal humidity level indicates that the load is dry. This category includes NORMAL, HEAVY DUTY, TOWELS, BEDDING, DELICATES, PERM PRESS, and ACTIVE WEAR. • Steam Dry cycles: The dryer sprays water into the drum to deodorize clothes and reduce static electricity and wrinkles. This category includes REFRESH, WRINKLE AWAY, and STEAM SANITIZE. • Manual Dry cycles: The drying time is fixed. This category includes TIME DRY and AIR FLUFF.
02 POWER	<p>Press to turn the Tumble Dryer on or off.</p>
03 START/PAUSE (Hold to Start)	<p>Press and hold to start operation or press to stop operation temporarily.</p>
04 Status bar	<p>The status bar shows current cycle information and estimated time remaining or an information code if the Tumble Dryer needs to be checked.</p>
05 Dry Level	<p>Press Dry Level to select a dry level.</p> <ul style="list-style-type: none"> • Larger or bulkier loads may require Very or More for complete dryness. • The Less dry level is best suited for lightweight fabrics or for leaving some moisture in the clothing at the end of the cycle. • The Damp dry level is designed to partially dry items. Use for items that lay flat or hang to dry. <p>NOTE This option is not available with: REFRESH, WRINKLE AWAY, STEAM SANITIZE, ACTIVE WEAR, TIME DRY, and AIR FLUFF.</p>

Operations

Operations

Operations

<p>06 Temp.</p>	<p>Press Temp. to change the temperature of the current cycle. High: For sturdy cottons or those labeled Tumble Dry. Medium: For permanent press, synthetics, lightweight cottons, or items labeled Tumble Dry Medium. Med Low: For heat lower than Medium. Use to dry synthetic or washable knit fabrics. Low: For heat sensitive items labeled Tumble Dry Low or Tumble Dry Warm. Extra Low: Provides the lowest heated drying temperature possible.</p>
<p>07 Time</p>	<p>Press Time to select a drying time for the selected cycle. This is available only with TIME DRY, AIR FLUFF, and WRINKLE AWAY. This button is not available for Sensor Dry cycles because exact drying times are determined by fluctuating humidity levels.</p>
<p>08 Wrinkle Prevent</p>	<p>Wrinkle Prevent provides approximately 180 minutes of intermittent tumbling in unheated air at the end of the cycle to reduce wrinkling. Press Wrinkle Prevent to activate this feature. The load is dry and can be removed at any time during the Wrinkle Prevent cycle.</p>
<p>09 Eco Dry</p>	<p>This function is available with NORMAL and TIME DRY. With the Eco Dry activated, drying takes a longer time but power consumption is reduced. The drying time can be extended by up to 3 times normal depending on the temperature and load. The Eco Dry function is enabled by default.</p>
<p>10 Mixed Load Bell</p>	<p>The Mixed Load Bell notifies you when the average dry level in a load is damp dry (80 % dried). This lets you take items that you don't want fully dried or that dry quickly out of the dryer early while letting others continue to dry. You can select this option in all Sensor Dry cycles except for ACTIVE WEAR, and STEAM SANITIZE. Available dry levels are Normal, More, and Very.</p>



11 Anti Static	<p>Anti Static reduces static electricity that occurs from clothing friction. This is done by spraying steam into the drum in a later stage of the drying cycle.</p> <p>NOTE</p> <p>The Anti Static function is only available with NORMAL, HEAVY DUTY, PERM PRESS, DELICATES, and TIME DRY.</p>
12 Adjust Time	<p>You can change the set time for the selected cycle. This is available only with TIME DRY, AIR FLUFF, and WRINKLE AWAY. To change the cycle time, press Adjust Time or Adjust Time until the desired time is displayed.</p>
13 Smart Control (Elec.) / Smart Monitor (Gas)	<p>After connecting the Tumble Dryer to your home network using the Samsung Smart Home app, you can control or monitor the dryer remotely. When started, the Smart Control (Smart Monitor) indicator blinks. The dryer enters waiting mode and waits for remote commands.</p>



Cycle overview

Sensor Dry cycles

Cycle	Description
NORMAL	<ul style="list-style-type: none"> For most fabrics including cottons and linens. If NORMAL is selected, the Eco Dry function is enabled by default. For more information, see Eco Dry in the Control panel section.
HEAVY DUTY	<ul style="list-style-type: none"> For drying items made out of heavy fabrics, such as jeans, corduroys, or work clothes, with high temperature heat.
TOWELS	<ul style="list-style-type: none"> For bath towels and similar items.
BEDDING	<ul style="list-style-type: none"> For bulky items such as blankets, sheets, and comforters.
DELICATES	<ul style="list-style-type: none"> For heat-sensitive items at a low drying temperature.
PERM PRESS	<ul style="list-style-type: none"> Use to dry wrinkle-free cottons, synthetic fabrics, knits, and permanent press fabrics automatically.
ACTIVE WEAR	<ul style="list-style-type: none"> For exercise wear and outdoor wear such as sports jerseys, training pants, water-repellent jackets, and other performance clothing. Thick fabrics like a zipper or velcro closure on a jacket, or training socks may not be completely dried.



Operations

Steam Dry cycles

Cycle	Description
REFRESH	<ul style="list-style-type: none">Use to smooth out wrinkles and reduce odors in loads of one to four items. With this cycle selected, a small amount of water is sprayed into the dryer drum after several minutes of tumbling with heat. Before removing the laundry, confirm that the laundry load is dry.
WRINKLE AWAY	<ul style="list-style-type: none">For best results, load 2-3 items at once. You can extend the drying time by a minimum of 20 minutes, depending on the item type or load. Before removing the laundry, confirm that the laundry load is dry.
STEAM SANITIZE	<ul style="list-style-type: none">Use to sanitize items by applying steam and high-temperature heat to the fabric. This cycle can make items soft and reduce smells. Confirm that the laundry load is wet or partially wet before starting this cycle.

Manual Dry cycles

Cycle	Description
TIME DRY	<ul style="list-style-type: none">You can specify a cycle time in minutes.If TIME DRY is selected, the Eco Dry function is enabled by default. For more information, see Eco Dry in the Control panel section.
AIR FLUFF	<ul style="list-style-type: none">Tumbles the load in room temperature air.

Simple steps to start

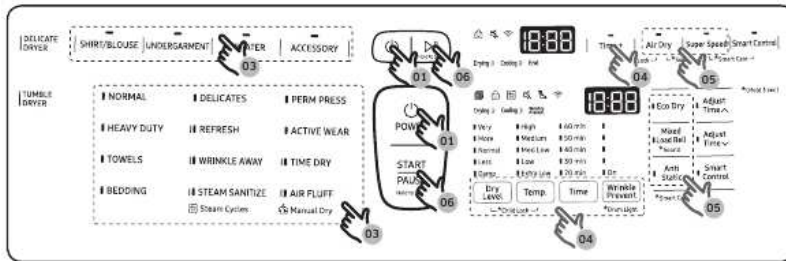

1. Press **POWER** on the control panel of a desired dryer (Delicate, Tumble) to turn the dryer on.
2. Put the items you want to dry into the dryer.
3. Select a cycle.
4. Change the cycle settings (temperature and/or dry level) as appropriate to the items.
5. Select cycle options as needed.
6. Press and hold **START/PAUSE**.

To change the cycle during operation

1. Press **START/PAUSE** to stop operation temporarily.
2. Select a different cycle.
3. Press and hold **START/PAUSE** again to start the new cycle.

WARNING

Do not put anything on top of your dryer while it is running.

Operations



This product is a smart dryer that supports the Samsung Smart Home service.

The amount of time the EZ setup function (for connecting the dryer to your network) can take to complete the network connection varies, depending on your network conditions.

Samsung Smart Home

Installation

Visit the Google Play Store, Galaxy Apps, or Apple App Store and search for "Samsung Smart Home". Download and install the Samsung Smart Home app provided by Samsung Electronics to your smart device.

NOTE

- The Samsung Smart Home app is designed for Android 4.0 (ICS) or higher, or iOS 8.0 or higher, and is optimized for Samsung smartphones (Galaxy S and Galaxy Note series).
- On other devices, some functions may operate differently.
- For improved performance, the Samsung Smart Home app is subject to change without notice.

Registering a Samsung account

To use the Samsung Smart Home app, you must first sign in to your Samsung account. If you don't have a Samsung account, select **Register** in the app, and then follow the on-screen instructions to create an account.

NOTE

- If you have a registered Samsung account, log into your Samsung account. If you have a Samsung smartphone, you can go to the **Settings** menu on your smartphone, select **Accounts**, and then sign in to your Samsung account. This will allow you to log in without additional authentication.
- For third-party smart phones, the app account must be the same as the EZ Setup account.

Getting started

Using Samsung Smart Home, you can control your dryer from your smart device remotely. For improved performance, the content and design of the app is subject to change without notice.

1. Launch the Samsung Smart Home App on your smartphone.
2. If 'Dryer' is not listed, tap **Add Device** > **Select other device** > **Dryer** on the app screen.
3. Press and hold **Smart Control** on your dryer's control panel for more than 5 seconds until the 'AP' message appears on the display.
4. When the device registration is complete, turn on the Smart Control function on your dryer and you can monitor (gas models) or control (electric models) your dryer remotely.
 - For gas models, the Dryer app only serves as a monitoring device. You cannot use any of the controls available on the app.

Operations

Special features

Child Lock

To prevent children or infants from accidentally starting the dryer or setting any of the dryer's functions, Child Lock locks all buttons except for the **POWER** button. Note that each dryer operates independently and has its own Child Lock function.

To activate the Child Lock

- Press and hold **Dry Level** and **Temp.** (or **Time+** and **Air Dry** for the Delicate Dryer) simultaneously for 3 seconds. Then, press **START/PAUSE** to activate. The door locks and the Child Lock indicator turns on.

To deactivate Child Lock temporarily

- You can deactivate Child Lock temporarily for 1 minute. To do this, press and hold **Dry Level** and **Temp.** (or **Time+** and **Air Dry** for the Delicate Dryer) simultaneously for 3 seconds. The door is unlocked for 1 minute and the Child Lock indicator blinks.

NOTE

- If you open the door 1 minute or more after deactivating Child Lock, an alarm sounds for up to 2 minutes.
- If you close the door within 2 minutes, the door locks and Child Lock is reactivated. If you do not close the door or the door is not properly closed within two minutes, an alarm sounds and the door will not lock.
- To add laundry after activating Child Lock, first deactivate Child Lock or restart the dryer.

To cancel Child Lock

- Press and hold **Dry Level** and **Temp.** (or **Time+** and **Air Dry** for the Delicate Dryer) for 3 seconds to deactivate, and then press and hold the buttons again for 3 seconds to release Child Lock. The door unlocks and the Child Lock indicator turns off.



Smart Care

The Smart Care function helps you diagnose and troubleshoot your dryer if it has a problem. To enable this function, you must first download the Samsung Smart Dryer app from the Play Store or the Apple Store, and then install it on a mobile device that has a built-in camera. The Smart Care function has been optimized for Galaxy and iPhone series devices. (It is not supported by some models.)

As the dryer operates, it runs a self-diagnosis function in the background. If it senses a problem, it displays an information code on the display which you can scan using the app's Smart Care function. The Smart Care function will then display detailed information about the code.

1. Press and hold **Anti Static** (or **Super Speed** and **Smart Control** for the Delicate Dryer) on the dryer for 3 seconds to enter the Smart Care mode.
2. Run the Samsung Smart Dryer app on your mobile device, and then tap **Smart Care**.
3. Hold the mobile device so that the mobile device and the dryer's status bar face each other. The app will recognize the information code automatically.
4. When the information code is recognized correctly, the app provides detailed information about the symptom and recommends further action.

NOTE

- The function name, Smart Care, may differ depending on your language.
- If the dryer display is reflecting light, the app may fail to recognize the information code.
- If the app fails to recognize the information code a number of times consecutively, enter the information code manually into the app screen.
- The information code history will be deleted after you use this function.

Sound

Mute or unmute the sound (button beeps, indicator beeps and chimes, etc.)

Delicate Dryer

- To mute the dryer's alarm sound or beeps, press and hold **Air Dry** and **Super Speed** for 3 seconds. To unmute, press and hold the same buttons again for 3 seconds.

Tumble Dryer

- To mute the dryer's alarm sound or beeps, press and hold **Mixed Load Bell** for 3 seconds. To unmute, press and hold the same button again for 3 seconds.

Drum Light (Tumble Dryer only)

The drum light turns on when the door is opened and turns off after 2 minutes. To manually turn the drum light on or off, press and hold **Wrinkle Prevent** for 3 seconds.

Maintenance

Keep your FlexDry™ dryer clean to prevent decreased performance and to lengthen its life.

WARNING

- The control board and inlet valve are intentionally not grounded and may present a risk of electric shock only during servicing.
- Service personnel: Do not contact these parts while the appliance is energized.

General cleaning and maintenance instructions

Main panel

- Clean with a soft, damp cloth. Do not use abrasive substances.
- Do not spray liquid cleaning agents directly on the display of the dryer.
- Some laundry pre-treatment soil and stain removers may damage the main panel.
- When using liquid cleaning agents, apply them to the cleaning cloth. Do not apply them directly to the dryer. Wipe up any spills or overspray immediately.

Exterior

- Clean with a soft, damp cloth. Do not use abrasive substances.
- Protect the surface from sharp objects.
- Do not place heavy or sharp objects or a detergent container on the dryer. They can scratch or damage the top cover of the dryer.
- The dryer has a high-gloss finish on its entire surface. Be careful not to scratch or damage the surface.

Exhaust system

- Check and clean the exhaust system on a yearly or regular basis to maintain optimum performance.
- The external exhaust hood must be cleaned more frequently to ensure proper air flow.

Vent sensor

The dryer features a vent sensor that detects and notifies you when it is time to clean the ductwork. The  indicator lets you know the status of the duct.

Level	 Indicator	Status	Action
0	Off	The ductwork is not clogged.	-
1	On	<ul style="list-style-type: none">The duct or lint filter is clogged.High pressure being applied to the duct because the duct is too long or bent.	<ul style="list-style-type: none">Check the lint filter or duct and clean if necessary.Check the duct connections and shorten or straighten the duct if necessary.
2	Blinking	<ul style="list-style-type: none">The duct or lint filter is severely clogged.The pressure applied to the duct is very high because the duct is too long or bent.	<ul style="list-style-type: none">Check and clean the lint filter or duct and make sure they are not clogged.Check the duct connections and shorten or straighten the duct work.

If the dryer is in the Level 2 state, the  indicator blinks for 3 hours after the completion of the current cycle. If you press **POWER** or open the door, the dryer powers off immediately.

NOTE

- For duct installation, see **Exhaust ducting guide** on page 31 and **Ducting requirements** on page 18.
- The dryer may keep running even if the duct is clogged, but the drying time will be extended.
- If the indicator turns on for the first time and is solid (not blinking), check and clean the lint filter and/or duct.
- If the indicator turns on again later, it is because the duct is installed or connected with some restrictions (it's too long or has too many bends). This is not a system failure. However, drying time may be extended or the drying performance may be degraded.

Maintenance

Delicate Dryer

Flexible rack

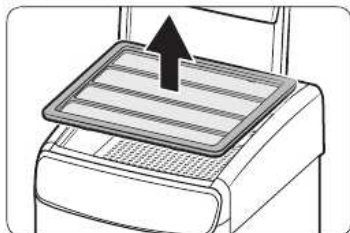

- If you use the flexible rack, make sure to clean the rack after every use so that it is readily available for future use.
- Clean the rack with neutral cleaning agents and running water.

Upper recesses

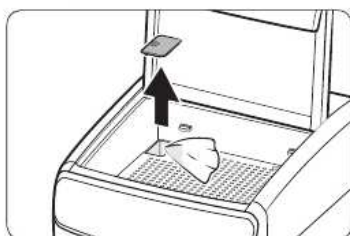

- Clean the left and right rear recesses of the Delicate Dryer after every use.
- Locate the recesses in the rear corners of the Delicate Dryer, and then remove the recess covers on both sides.
- The Delicate Dryer may have collected water while it is operating. After every use or while the Delicate Dryer is operating, remove the covers of the rear recesses, and then clean the recesses using a soft dry cloth.
- By design, the surface of the Delicate Dryer is slanted to facilitate collection of water.

Dryer-sheet case

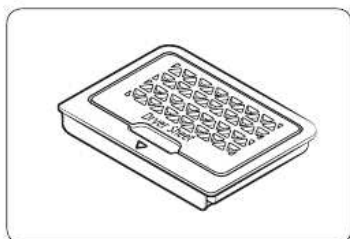

- Clean the Dryer-sheet case with neutral cleaning agents and running water.



Tumble Dryer

Stainless steel drum

- Clean the drum after every use.
- To clean the stainless steel drum, use a damp cloth with a mild, non-abrasive cleaner suitable for easily marred surfaces. Remove cleaner residue and dry with a clean cloth.

Drying rack

- If you used the lower drying rack, make sure to clean the rack after every use so that it is readily available for future use.
- Clean the drying rack with neutral cleaning agents and running water.



Troubleshooting

Checkpoints

If the dryer operates abnormally, first check the list of problems in the table below and try the suggested actions.

Symptom	Action
Does not run.	<ul style="list-style-type: none">• Make sure the door is latched shut.• Make sure the power cord is plugged into a live electrical outlet.• Check your home's circuit breakers or fuses.• Press and hold START/PAUSE again if the door was opened during a cycle.• Clean the lint filter.• If you are using the Delicate Dryer but it does not operate properly, you can turn the Tumble Dryer on and see if an information code appears.
Does not heat.	<ul style="list-style-type: none">• Check your home's circuit breakers or fuses.• Some cycles do not require heat. Check the selected cycle again.• For a gas dryer, make sure the gas supply is on.• Clean the lint filter and exhaust duct.• The dryer may have moved into the cool-down phase of the cycle.
Does not dry.	<ul style="list-style-type: none">• Check all of the above, plus...• Make sure the exhaust hood outside your home can open and close freely.• Check the exhaust system for lint buildup. Ducting should be inspected and cleaned annually.• Use a 4" rigid metal exhaust duct.• Do not overload. 1 wash load = 1 dryer load.• Dry heavy items and light weight items separately.• Large, bulky items, such as blankets or comforters, may require repositioning to ensure even drying.• The load may be too small to tumble properly. Add a few towels and restart the dryer.• The load may be too large to tumble properly. Remove some items and restart the dryer.• Clean the lint filter.

Troubleshooting

Symptom	Action
Is noisy.	<ul style="list-style-type: none"> • Check the load for objects such as coins, loose buttons, nails, etc. Remove promptly. • It is normal to hear the dryer gas valve or heating element cycle on and off during the drying cycle. • Make sure the dryer is leveled properly as outlined in the installation instructions. • It is normal for the dryer to hum due to the high velocity of air moving through the dryer drum, fan, or exhaust system.
Dries unevenly.	<ul style="list-style-type: none"> • Seams, pockets, and other similarly heavy areas may not be completely dry when the rest of the load has reached the selected dryness level. This is normal. You can choose a higher dryness level or a cycle that involves a higher dryness level. • If one heavy item is dried with a light weight load, such as one towel with sheets, it is possible that the heavy item will not be completely dry when the rest of the load has reached the selected dryness level. • For the best drying results, dry heavy items and light weight items separately.
Has odors.	<ul style="list-style-type: none"> • Household odors from paint, varnish, strong cleaners, etc. may enter the dryer with the surrounding room air. This is normal as the dryer draws the air from the room, heats it, pulls it through the drum, and exhausts it outside. • When these odors linger in the air, completely ventilate the room before using the dryer.
Lint on clothes.	<ul style="list-style-type: none"> • Make sure the lint filter is cleaned before every load. For clothes that naturally build up lint, clean the filter during the cycle. • Some fabrics are lint producers (for example, a fuzzy white cotton towel) and they must be dried separately from clothes that are lint trappers (for example, a pair of black linen pants). • Divide larger loads into smaller loads for drying. • Check pockets thoroughly before drying, then dry clothes. • Remove lint inside the drum before drying a load.

Troubleshooting

Troubleshooting

Symptom	Action
Items still wrinkled after Wrinkle Prevent (Wrinkle Away, Wrinkle Release).	<ul style="list-style-type: none">• Small loads of 1 to 4 items work best.• Load fewer items. Load similar-type items.• Take out the items immediately after drying is complete.
Water drips from the nozzle when the Steam cycles starts.	<ul style="list-style-type: none">• This is steam condensation. The dripping water will stop after a short time.
Sprayed water is not visible during Steam cycles.	<ul style="list-style-type: none">• Sprayed water is difficult to see when the door is closed.
Extended time.	<ul style="list-style-type: none">• Sensor Dry automatically senses the moisture in the load and shuts the dryer off when the selected dryness level is reached. <p>The drying time can change according to the type and amount of laundry. See the cycle chart for reference.</p>

If a problem persists, contact a local Samsung service center.

Samsung Smart Home

Symptom	Action
I could not find "Samsung Smart Home" in the app market.	<ul style="list-style-type: none">The Samsung Smart Home app is available for smartphones that run Android 4.0 (ICS) or higher, or iOS 8.0 or higher.
The Samsung Smart Home app fails to operate.	<ul style="list-style-type: none">The Samsung Smart Home app is available for applicable models only.The old Samsung Smart Dryer app cannot connect with Samsung Smart Home models.
The Samsung Smart Home app is installed but is not connected to my dryer.	<ul style="list-style-type: none">You must log into your Samsung account to use the app.Use the Samsung Smart Home app to connect and register the dryer with your home network access point (AP).Make sure that your router is operating normally.
Could not log into the app.	<ul style="list-style-type: none">You must log into your Samsung account to use the app.If you don't have a Samsung account, follow the app's onscreen instructions to create one.
An error message appears when I try to register my dryer.	<ul style="list-style-type: none">The connection may fail due to the distance from your access point (AP) or electrical interference from the surrounding environment. Wait a moment and try again.
The Samsung Smart Home app is successfully connected to my dryer but does not run.	<ul style="list-style-type: none">Exit and restart the Samsung Smart Home app or unplug your router and then reconnect it.

Troubleshooting

Information codes

If the dryer fails to operate, you may see an information code on the control panel. To determine what you should do, check the list of codes in the table below, and then try the suggested actions.

Code		Action
Delicate Dryer	Tumble Dryer	
1 DC	DC	Operating the dryer with the door open. <ul style="list-style-type: none"> • Make sure the door is properly closed. • Make sure laundry is not caught in the door.
1 FC	FC	Invalid power source frequency. <ul style="list-style-type: none"> • Try restarting the cycle. • If this information code remains, contact a Samsung service center.
1 AC	AC	Electronic control problem [Invalid Communication (SUB PBA <-> MAIN PBA)]. <ul style="list-style-type: none"> • Contact a Samsung service center.
1 HC	HC	High temperature heating check. <ul style="list-style-type: none"> • Clean the lint filter. • If this information code remains, contact a Samsung service center.
-	9C1	The electronic control needs to be checked. <ul style="list-style-type: none"> • Check if power is supplied properly. • If the information code remains, contact a Samsung service center.
1 tC	tC	The Thermistor1 resistance is very low or high. <ul style="list-style-type: none"> • Check for a clogged lint screen. • Check if the vent system is restricted. • If this information code remains, contact a Samsung service center.
1 tC5	tC5	The Thermistor2 resistance is very low or high. <ul style="list-style-type: none"> • Check for a clogged lint screen. • Check if the vent system is restricted. • If this information code remains, contact a Samsung service center.
-	dF	Incorrect door switch. <ul style="list-style-type: none"> • Contact a Samsung service center.

Troubleshooting

Code		Action
Delicate Dryer	Tumble Dryer	
1 AC7	-	Electronic Control Problem [Invalid Communication (Delicate Dryer MAIN <-> Tumble MAIN PBA)].
-	HC2	Gas ignition fails. <ul style="list-style-type: none"> • Make sure the gas valve is unlocked. • Make sure the filter is unclogged. • Make sure the plumbing is not disconnected nor clogged.



If any information code keeps appearing on the screen, contact a Samsung service center.

Specifications

Fabric care chart

The following symbols provide garment care direction. The clothing care labels include symbols for drying, bleaching, ironing, and dry cleaning. The use of symbols ensures consistency among garment manufacturers of domestic and imported items. Follow care label directions to optimize garment life and reduce laundering problems.

Wash cycle

	Normal
	Permanent press / Wrinkle resistant / Wrinkle control
	Gentle / Delicates
	Hand wash

Water temperature

...	Hot
..	Warm
.	Cold

NOTE

The Water Temperature table lists appropriate wash water temperatures for various items. The temperature range is 106-126 °F (41-52 °C) for Hot, 84-106 °F (29-41 °C) for Warm, and 61-84 °F (16-29 °C) for Cold. (Wash water temperature must be a minimum of 61 °F (16 °C) for detergent activation and effective cleaning.)

Bleach

	Any bleach (when needed)
	Only non-chlorine (color-safe) bleach (when needed)
	Tumble dry





Normal

	Permanent press / Wrinkle resistant / Wrinkle control
	Gentle / Delicates

Special instructions

	Line dry / Hang to dry
	Drip dry
	Dry flat







Heat setting

	High
	Medium
	Low
	Any heat
	No heat / Air





Iron dry or steam temperatures

	High
	Medium
	Low

Warning symbols for laundering

	Do not wash
	Do not wring
	Do not bleach
	Do not tumble dry
	No steam (added to iron)
	Do not iron

Dry-clean

	Dry-clean
	Do not dry-clean
	Line dry / Hang to dry
	Drip dry
	Dry flat

Protecting the environment

This appliance is manufactured from recyclable materials. If you decide to dispose of this appliance, please observe local waste disposal regulations. Cut off the power cord so that the appliance cannot be connected to a power source. Remove the door so that animals and small children cannot get trapped inside the appliance.

Specifications

Specification sheet

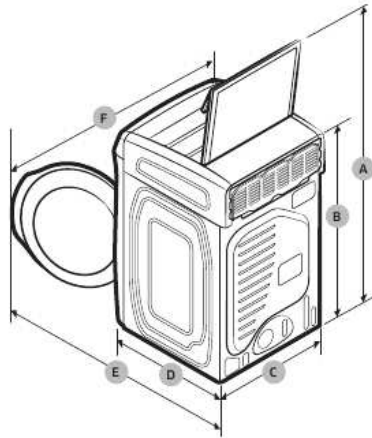

Type		Front loading dryer DV60M9900**	
Dimensions	A. Height-top door opened	Product-inches (cm)	61 (155.0)
		Required for Installation-inches	63.5
	B. Height-top door closed	Product-inches (cm)	46.9 (119.2)
		Required for Installation-inches	-
	C. Width	Product-inches (cm)	27 (68.6)
		Required for Installation-inches	29
	D. Depth	Product-inches (cm)	3.25 (82.5)
		Required for Installation-inches	34.5
	E. Depth with door open 90°	Product-inches (cm)	53.7 (136.5)
		Required for Installation-inches	55.7
	F. Width with door open 120°	Product-inches (cm)	36.4 (92.4)
		Required for Installation-inches	38.4
Water pressure-psi (kPa)		20-116 (137-800)	
Weight	lb (kg)	165 (75)	
Heater rating	Electric (W)	Upper : 600 W / Lower : 5300 W	
	Gas (BTU/hr)	Upper : 600 W / Lower : 22000 BTU/hr (eq. 6447 W)	

Cycle chart

NOTE

For best results, follow the load size recommendations for each dry cycle.

- Large load: Fill the drum to about $\frac{3}{4}$ full. Do not add items over this level as they need to tumble freely.
- ◐ Medium load : Fill the drum to about $\frac{1}{2}$ full.
- Small load : Fill the drum with 3-5 items, not more than $\frac{1}{4}$ full.

Cycle	Recommended items	Load size	Dry Level
NORMAL	Cottons, work clothes, linens, mixed loads	●	Normal Dry (Adjustable)
HEAVY DUTY	Heavy Fabrics such as jeans, corduroys, heavy work clothes	●	Normal Dry (Adjustable)
BEDDING	Bulky items such as blankets, sheets, comforters, pillows	●	Normal Dry (Adjustable)
PERM PRESS	Shirts, synthetic fabrics, knits, wrinkle-free cottons, permanent press	◐	Normal Dry (Adjustable)
DELICATES	Underwear, blouses, lingerie	◐	Normal Dry (Adjustable)
ACTIVE WEAR	Water-repellent wear, performance clothes, sports wear (Maximum: 4 lbs)	◐	Normal Dry (Not adjustable)
TIME DRY	Any load	●	-
AIR FLUFF	Foam, rubber, plastic	○	-
REFRESH	Shirts, trousers, comforters, pillows	◐	-
WRINKLE AWAY	Shirts, trouser, blouses	◐	-
STEAM SANITIZE	Bedding, curtains, children's clothing	◐	Very Dry (Not adjustable)

Specifications

Specifications

NOTE

- : factory setting, ●: can be selected

Cycle	Temperature setting					Time setting
	High	Medium	Med Low	Low	Extra Low	
NORMAL		●				
HEAVY DUTY	●					
BEDDING	●					
PERM PRESS		●				
DELICATES					●	
ACTIVE WEAR		●				
TIME DRY	●	●	●	●	●	●
AIR FLUFF						●
REFRESH	●					
WRINKLE AWAY	●					●
STEAM SANITIZE	●					

Cycle	Options				
	Anti Static	Mixed Load Bell	Wrinkle Prevent	Adjust Time	Eco Dry
NORMAL	●	●	●		●
HEAVY DUTY	●	●	●		
BEDDING		●	●		
PERM PRESS	●	●	●		
DELICATES	●	●	●		
ACTIVE WEAR			●		
TIME DRY	●		●	●	●
AIR FLUFF			●	●	
REFRESH			●		
WRINKLE AWAY			●	●	
STEAM SANITIZE			●		

Specifications

Warranty (U.S.A)

SAMSUNG DRYER

LIMITED WARRANTY TO ORIGINAL PURCHASER

This SAMSUNG brand product, as supplied and distributed by SAMSUNG ELECTRONICS AMERICA, INC. (SAMSUNG) and delivered new, in the original carton to the original consumer purchaser, is warranted by SAMSUNG against manufacturing defects in materials and workmanship for a limited warranty period of:

- One (1) Year All Parts and Labor

This limited warranty begins on the original date of purchase, and is valid only on products purchased and used in the United States.

To receive warranty service, the purchaser must contact SAMSUNG for problem determination and service procedures.

Warranty service can only be performed by a SAMSUNG authorized service center.

The original dated bill of sale must be presented upon request as proof of purchase to SAMSUNG or SAMSUNG's authorized service center.

SAMSUNG will provide in-home service during the warranty period at no charge, subject to availability within the contiguous United States.

In-home service is not available in all areas.

To receive in-home service, product must be unobstructed and accessible to the service agent.

If service is not available, SAMSUNG may elect to provide transportation of the product to and from an authorized service center.

SAMSUNG will repair, replace, or refund this product at our option and at no charge as stipulated herein, with new or reconditioned parts or products if found to be defective during the limited warranty period specified above.

All replaced parts and products become the property of SAMSUNG and must be returned to SAMSUNG.

Replacement parts and products assume the remaining original warranty, or ninety (90) days, whichever is longer.

Warranty (U.S.A)

This limited warranty covers manufacturing defects in materials and workmanship encountered in normal, noncommercial use of this product and shall not apply to the following: damage that occurs in shipment; delivery and installation; applications and uses for which this product was not intended; altered product or serial numbers; cosmetic damage or exterior finish; accidents, abuse, neglect, fire, water, lightning, or other acts of nature or God; use of products, equipment, systems, utilities, services, parts, supplies, accessories, applications, installations, repairs, external wiring or connectors not supplied or authorized by SAMSUNG that damage this product or result in service problems; incorrect electrical line voltage, fluctuations and surges; customer adjustments and failure to follow operating instructions, maintenance and environmental instructions that are covered and prescribed in the instruction book; product removal and reinstallation; problems caused by pest infestations.

This limited warranty does not cover problems resulting from incorrect electric current, voltage or supply, light bulbs, house fuses, house wiring, cost of a service call for instructions, or fixing installation errors.

SAMSUNG does not warrant uninterrupted or error-free operation of the product.

EXCEPT AS SET FORTH HEREIN, THERE ARE NO WARRANTIES ON THIS PRODUCT EITHER EXPRESS OR IMPLIED, AND SAMSUNG DISCLAIMS ALL WARRANTIES INCLUDING, BUT NOT LIMITED TO, ANY IMPLIED WARRANTIES OF MERCHANTABILITY, INFRINGEMENT OR FITNESS FOR A PARTICULAR PURPOSE.

NO WARRANTY OR GUARANTEE GIVEN BY ANY PERSON, FIRM, OR CORPORATION WITH RESPECT TO THIS PRODUCT SHALL BE BINDING ON SAMSUNG.

SAMSUNG SHALL NOT BE LIABLE FOR LOSS OF REVENUE OR PROFITS, FAILURE TO REALIZE SAVINGS OR OTHER BENEFITS, OR ANY OTHER SPECIAL, INCIDENTAL OR CONSEQUENTIAL DAMAGES CAUSED BY THE USE, MISUSE, OR INABILITY TO USE THIS PRODUCT, REGARDLESS OF THE LEGAL THEORY ON WHICH THE CLAIM IS BASED, AND EVEN IF SAMSUNG HAS BEEN ADVISED OF THE POSSIBILITY OF SUCH DAMAGES. NOR SHALL RECOVERY OF ANY KIND AGAINST SAMSUNG BE GREATER IN AMOUNT THAN THE PURCHASE PRICE OF THE PRODUCT SOLD BY SAMSUNG AND CAUSING THE ALLEGED DAMAGE.

WITHOUT LIMITING THE FOREGOING, PURCHASER ASSUMES ALL RISK AND LIABILITY FOR LOSS, DAMAGE, OR INJURY TO PURCHASER AND PURCHASER'S PROPERTY AND TO OTHERS AND THEIR PROPERTY ARISING OUT OF THE USE, MISUSE, OR INABILITY TO USE THIS PRODUCT.

THIS LIMITED WARRANTY SHALL NOT EXTEND TO ANYONE OTHER THAN THE ORIGINAL PURCHASER OF THIS PRODUCT, IS NONTRANSFERABLE AND STATES YOUR EXCLUSIVE REMEDY.

Some states do not allow limitations on how long an implied warranty lasts, or the exclusion or limitation of incidental or consequential damages, so the above limitations or exclusions may not apply to you. This warranty gives you specific rights, and you may also have other rights, which vary from state to state.

To obtain warranty service, please contact SAMSUNG at:

Samsung Electronics America, Inc.

85 Challenger Road

Ridgefield Park, NJ 07660

1-800-SAMSUNG (726-7864)

www.samsung.com/us/support

Visits by a Service Engineer to explain functions, maintenance, or installation is not covered by warranty.
Please contact the Samsung call center at the number above for help with any of these issues.