

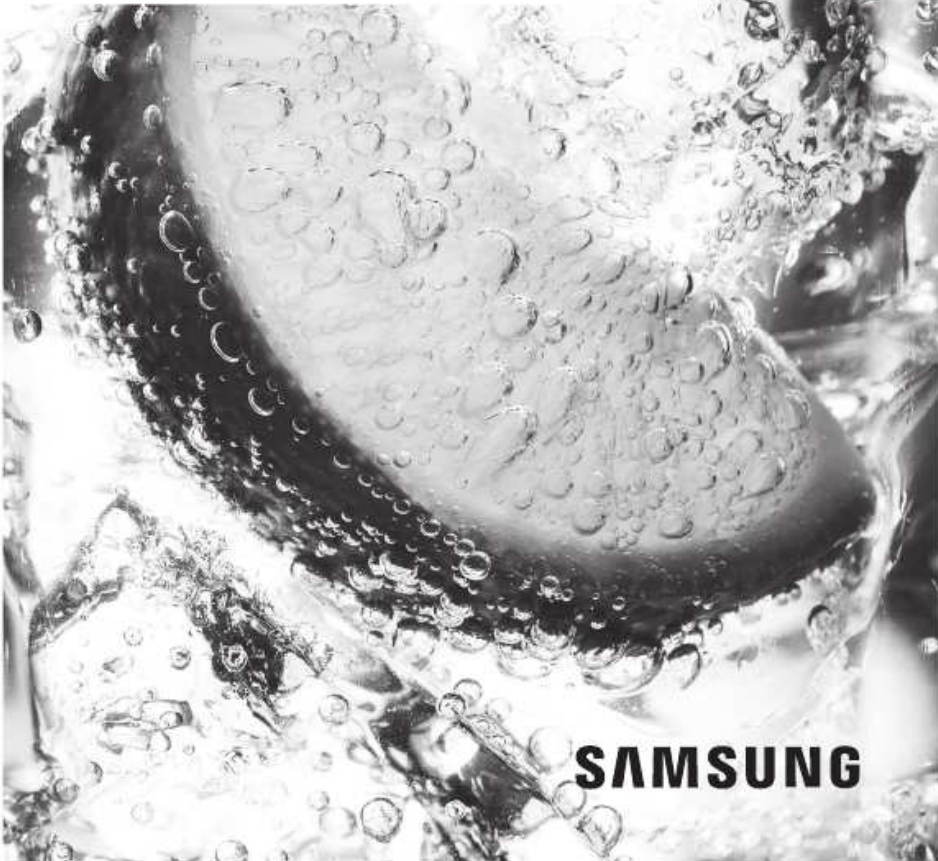

Refrigerator

User manual

Free Standing Appliance



SAMSUNG

Contents

Safety information	3
What you need to know about the safety instructions	3
Important safety symbols and precautions:	4
State of California Proposition 65 Warning	4
Important safety precautions	4
Severe warning signs for transportation and site	6
Critical installation warnings	6
Installation cautions	8
Critical usage warnings	8
Usage cautions	11
Cleaning cautions	12
Critical disposal warnings	13
Installation	14
Refrigerator at a glance	14
Step-by-step installation	19
Operations	38
Main panel	38
Special features	45
Maintenance	50
Handling and care	50
Cleaning	54
Replacement	55
Troubleshooting	57
General	57
Do you hear abnormal sounds from the refrigerator?	61
LIMITED WARRANTY (U.S.A.)	63
SAMSUNG REFRIGERATOR	63
Warranty Information (CANADA)	66
If your refrigerator needs service	66
Limited Warranty for Original Purchaser	66
Obligation to the Original Owner	67
Exclusions of the Warranty	67

Safety information

Before using your new Samsung Refrigerator, please read this manual thoroughly to ensure that you know how to operate the features and functions that your new appliance offers safely and efficiently.

What you need to know about the safety instructions

- This appliance is not intended for use by persons (including children) with reduced physical, sensory or mental capabilities, or lack of experience and knowledge, unless they have been given supervision or instruction concerning use of the appliance by a person responsible for their safety. Children should be supervised to ensure that they do not play with the appliance.
- Because the following instructions cover various models, the characteristics of your refrigerator may differ slightly from the refrigerator described in this manual.
- If you have any question, contact us at 1-800-SAMSUNG or find help and information online at www.samsung.com.
- Refrigerant squirting out of the pipes could ignite or cause an eye injury. When refrigerant leaks from the pipe, avoid any naked flames and move anything flammable away from the product and ventilate the room immediately.
 - Failing to do so may result in fire or explosion.
- Improper use of the grounding plug can result in a risk of electric shock. If it is necessary to use an extension cord, use only a 3-wire extension cord that has a 3-blade grounding plug and a 3-slot receptacle that will accept the plug on the appliance. The marked rating of the extension cord should be AC 115-120 V, 10 A, or more. If a grounding adapter is used, make sure the receptacle box is fully grounded.

Safety information

Important safety symbols and precautions:

Please follow all safety instructions in this manual. This manual uses the following safety symbols.

WARNING

Hazards or unsafe practices that may result in **severe personal injury, property damage, and/or death.**

CAUTION

Hazards or unsafe practices that may result in **severe personal injury and/or property damage.**

NOTE

Useful information that helps users understand or benefit from the refrigerator.

These warning signs are here to prevent injury to you and others.

Please follow them carefully.

After reading this section, keep it in a safe place for future reference.

State of California Proposition 65 Warning

WARNING

Cancer and Reproductive Harm - www.P65Warnings.ca.gov.

Important safety precautions



Warning; Risk of fire / flammable materials

WARNING

- R-600a is used as a refrigerant. This product contains flammable gas (Refrigerant R-600a), contact your local authority in regard to safe disposal of this product.
- In order to avoid the creation of a flammable gas-air mixture if a leak in the refrigerating circuit occurs, the size of the room in which the appliance may be sited depends on the amount of refrigerant used. The room must be 35.3 ft³ in size for every 8 g of R-600a refrigerant inside the appliance.
- The installation location should not be exposed to direct sunlight and not placed near any electric appliance or heat source, e.g. stove, oven or hob, radiator, etc.

- If you use two products side by side, for safety reason, be sure to use certified products in explosive gas atmospheres.
- Never start up an appliance showing any signs of damage. If in doubt, consult your dealer.
- If the supply cord is damaged, it must be replaced by the manufacturer, its service agent or similarly qualified persons in order to avoid a hazard.
- The socket must be easily accessible so that the appliance can be quickly disconnected from the supply in an emergency. It must be outside the area of the rear of the appliance.
- Do not store explosive substances such as aerosol cans with a flammable propellant in this appliance.
- New hose-sets supplied with the appliance are to be used and that old hose-sets should not be reused.
- When positioning the appliance, ensure the supply cord is not trapped or damaged.
- Do not locate multiple portable socket-outlets or portable power supplies at the rear of the appliance.

WARNING

- Fill with potable water only.
- Keep ventilation openings, in the appliance enclosure or in the built-in structure, clear of obstruction.
- Do not use mechanical devices or other means to accelerate the defrosting process, other than those recommended by the manufacturer.
- Do not damage the refrigerant circuit.
- Do not use electrical appliances inside the food storage compartments of The appliance, unless they are of the type recommended by the manufacturer.
- Connect to potable water supply only.

WARNING

- Risk of child entrapment. Before you throw away your old refrigerator or freezer:
 - Take off the doors.
 - Leave the shelves in place so that children may not easily climb inside.

This appliance is intended to be used in household and similar applications such as

- staff kitchen areas in shops, offices and other working environments;
- farm houses and by clients in hotels, motels and other residential type environments;
- bed and breakfast type environments;
- catering and similar non-retail applications.

Safety information

Severe warning signs for transportation and site

WARNING

- When transporting and installing the appliance, care should be taken to ensure that no parts of the refrigerating circuit are damaged.
 - Refrigerant leaking from the pipe work could ignite or cause an eye injury. If a leak is detected, avoid any naked flames or potential sources of ignition and air the room in which the appliance is standing for several minutes.
 - This appliance contains a small amount of isobutane refrigerant (R-600a), a natural gas with high environmental compatibility that is, however, also flammable.

Critical installation warnings

WARNING

- Do not install the refrigerator in a damp location or place where it may come in contact with water.
 - Deteriorated insulation on electrical parts may cause an electric shock or fire.
- Do not place this refrigerator in direct sunlight or expose it to the heat from stoves, room heaters, or other appliances.
- Do not plug several appliances and the refrigerator into the same multiple power strip. The refrigerator should always be plugged into its own individual electrical outlet which has a voltage rating that matches the voltage listed on the refrigerator's rating plate.
 - This provides the best performance and also prevents overloading of house wiring circuits, which could overheat the wires and cause a fire hazard.
- If the wall socket is loose, do not insert the power plug.
 - There is a risk of electric shock or fire.
- Do not use a power cord that has cracks or abrasion damage along its length or at either end.
- Do not bend the power cord excessively or place heavy objects on it.
- Do not pull or excessively bend the power cord.
- Do not twist or tie the power cord.
- Do not hook the power cord over a metal object, place a heavy object on the power cord, insert the power cord between objects, or push the power cord into the space behind the appliance.
- When moving the refrigerator, be careful not to roll over or damage the power cord.
 - This may result in an electric shock or fire.
- Never unplug your refrigerator by pulling on the power cord. Always grip the plug firmly and pull straight out from the outlet.
 - Damage to the cord may cause a short-circuit, fire, and/or electric shock.
- Do not install this appliance near a heater or flammable material.
- Do not install this appliance in a location where gas may leak.
 - This may result in an electric shock or fire.
- This refrigerator must be properly located and installed in accordance with the instructions in this manual before you use it.

- Connect the power plug in the proper position with the cord hanging down.
 - If you connect the power plug upside down, the wire can get cut off and cause a fire or electric shock.
- Make sure that the power plug is not crushed or damaged by the back of the refrigerator.
- Keep the packing materials out of reach of children.
 - There is a risk of death from suffocation if a child puts the packing materials on his or her head.
- The appliance must be positioned so that the plug is accessible after installation.
 - Failing to do so may result in an electric shock or fire due to electric leakage.
- Do not install this appliance in a humid, oily or dusty location, or in a location exposed to direct sunlight or to water (rain drops).
 - Deteriorated insulation on electrical parts may cause an electric shock or fire.
- If large amounts of dust or water enter the refrigerator, disconnect the power plug and contact a Samsung Electronics service center.
 - Otherwise there is a risk of fire.
- Do not stand on top of the appliance or place objects (such as laundry, lighted candles, lighted cigarettes, dishes, chemicals, metal objects, etc.) on the appliance.
 - This may result in an electric shock, fire, problems with the product, or injury.
- You need to remove all the protective plastic film before you initially plug the product in.
- Children should be supervised to ensure that they do not play with the snap rings used for door adjustment or the water tube clips.
 - There is risk of death by suffocation if a child swallows a snap ring or water tube clip. Keep the snap rings and water tube clips out of children's reach.
- The refrigerator must be safely grounded.
 - Always make sure that you have grounded the refrigerator before attempting to investigate or repair any part of the appliance. Power leakages can cause severe electric shock.
- Never use gas pipes, telephone lines, or other potential lightning attractors as an electrical ground.
 - You must ground the refrigerator to prevent any power leakages or electric shocks caused by current leakage from the refrigerator.
 - Current leakage may result in an electric shock, fire, explosion, or problems with the product.
- Plug the power plug into the wall socket firmly. Do not use a damaged power plug, damaged power cord, or loose wall socket.
 - This may result in an electric shock or fire.
- Only a qualified technician or service company should be allowed to change the fuse in the refrigerator.
 - Failing to do so may result in an electric shock or personal injury.

Safety information

Installation cautions

CAUTION

- Allow sufficient space around the refrigerator and install it on a flat surface.
 - Keep the ventilation space in the appliance enclosure or mounting structure clear of obstructions.
- After you have installed the refrigerator and turned it on, allow the appliance to stand for 2 hours before loading it with food.
- It is strongly recommended you have a qualified technician or service company install the refrigerator.
 - Failing to do so may result in an electric shock, fire, explosion, problems with the product, or injury.
- Overloading one door may make the refrigerator fall, causing physical injury.

Critical usage warnings

WARNING

- Do not insert the power plug into a wall socket with wet hands.
 - This may result in an electric shock.
- Do not store articles on the top of the appliance.
 - When you open or close the door, the articles may fall and cause personal injury and/or material damage.
- Do not insert hands, feet, or metal objects (such as chopsticks, etc.) into the bottom or the back of the refrigerator.
 - This may result in an electric shock or injury.
 - Any sharp edges may cause a personal injury.
- Do not touch the inside walls of the freezer or products stored in the freezer with wet hands.
 - This may cause frostbite.
- Do not put a container filled with water on the refrigerator.
 - If spilled, there is a risk of fire or electric shock.
- Do not keep volatile or flammable objects or substances (benzene, thinner, propane gas, alcohol, ether, LP gas, and other such products) in the refrigerator.
 - This refrigerator is for storing food only.
 - This may result in fire or explosion.
- Children should be supervised to ensure that they do not play with the appliance.
 - Keep fingers out of "pinch point" areas. Clearances between the doors and cabinet are necessarily small. Be careful when you open the doors if children are in the area.
- Do not let children hang on the door or door bins. A serious injury may occur.
- Do not let children go inside the refrigerator. They could become trapped.
- Do not insert your hands into the area under the appliance.
 - Any sharp edges may cause personal injury.

- Do not store pharmaceutical products, scientific materials, or temperature sensitive products in the refrigerator.
 - Products that require strict temperature controls must not be stored in the refrigerator.
- Do not place or use electrical appliances inside the refrigerator/freezer, unless they are of a type recommended by the manufacturer.
- If you smell smoke, pull out the power plug immediately, and then contact a Samsung Electronics service center.
- If large amounts of dust or water enter the refrigerator, disconnect the power plug and contact your Samsung Electronics service center.
 - Otherwise there is a risk of fire.
- Do not let children step on a drawer.
 - The drawer may break and cause them to slip.
- Do not leave the doors of the refrigerator open while the refrigerator is unattended and do not let children enter the refrigerator.
- Do not allow babies or children to go into a drawer.
 - It can cause death from suffocation by entrapment or personal injury.
- Do not overfill the refrigerator with food.
 - When you open the door, an item may fall out and cause personal injury or material damage.
- Do not spray volatile material such as insecticide onto the surface of the appliance.
 - As well as being harmful to humans, it may also result in an electric shock, fire, or problems with the product.
- Never put fingers or any objects into the water dispenser outlet, ice chute, or ice maker bucket.
 - It may cause a personal injury or material damage.
- Do not use or place any substances sensitive to temperature such as flammable sprays, flammable objects, dry ice, medicine, or chemicals near or inside the refrigerator.
- Do not use a hair dryer to dry the inside of the refrigerator. Do not place a lighted candle in the refrigerator to remove bad odors.
 - This may result in an electric shock or fire.
- Fill the water tank and ice cube trays with potable water only (tap water, mineral water, or purified water).
 - Do not fill the tank with tea, juice, or a sports drink. They can damage the refrigerator.
- Do not stand on top of the appliance or place objects (such as laundry, lighted candles, lighted cigarettes, dishes, chemicals, metal objects, etc.) on the appliance. This may result in an electric shock, fire, problems with the product, or injury. Do not put a container filled with water on the appliance.
 - If spilled, there is a risk of fire or electric shock.
- Never stare directly at the UV LED lamp for long periods of time.
 - This may result in eye strain due to the ultraviolet rays.
- Do not put a fridge shelf into the refrigerator upside down. The shelf stopper will not work.
 - The glass shelf could fall and cause personal injury.
- Keep fingers out of "pinch point" areas. Clearances between the doors and cabinet are necessarily small. Be careful when you open the doors if children are in the area.

Safety information

- If a gas leak is detected, avoid any naked flames or potential sources of ignition, and air the room in which the appliance is standing for several minutes.
 - Do not touch the appliance or power cord.
 - Do not use a ventilating fan.
 - A spark may result in an explosion or fire.
- Use only the LED Lamps provided by the manufacturer or its service agents.
- Bottles should be stored tightly together so that they do not fall over or out.
- This product is intended only for the storage of food in a domestic environment.
- Never put fingers or any objects into the water dispenser outlet, ice chute, or ice maker bucket.
 - This can cause a personal injury or material damage.
- Do not attempt to repair, disassemble, or modify the refrigerator yourself.
 - Unauthorized modifications can cause safety problems. To reverse an unauthorized modification, we will charge the full cost of parts and labor.
- Do not use any fuse (such as copper, steel wire, etc.) other than a standard fuse.
- If your refrigerator needs to be repaired or reinstalled, contact your nearest Samsung service center.
 - Failing to do so may result in an electric shock, fire, problems with the product, or injury.
- If the interior or exterior LED lamp has gone out, contact your nearest Samsung service center.
- If the refrigerator emits a burning smell or smoke, unplug the refrigerator immediately and contact a Samsung service center.
 - Failing to do so may result in an electric or fire hazards.
- Pull the power plug out of the socket before changing the interior lamps of the refrigerator.
 - Otherwise, there is a risk of electric shock.
- If you experience difficulty changing a non-LED light, contact a Samsung service center.
- If the product is equipped with LED lamps, do not disassemble the Lamp Covers and LED lamps yourself.
 - Contact a Samsung service center.
- Plug the power plug into the wall socket firmly.
- Do not use a damaged power plug, damaged power cord, or loose wall socket.
 - This may result in an electric shock or fire.

Usage cautions

CAUTION

- Do not re-freeze frozen foods that have thawed completely.
- Use only the ice maker provided with the refrigerator.
- To get the best performance from the product:
 - Do not place food too close to the vents at the rear of the refrigerator as this can obstruct free air circulation in the refrigerator compartment.
 - Wrap food up properly or place it in airtight containers before putting it into the refrigerator.
 - Please observe maximum storage times and expiration dates of frozen goods.
- Do not put glass containers or bottles or carbonated beverages into the freezer.
 - The container may freeze and break, and this may result in injury.
- Service Warranty and Modification:
 - Any changes or modifications performed by a 3rd party on this finished appliance are not covered under Samsung warranty service, nor is Samsung responsible for safety issues that result from 3rd party modifications.
- Do not block the air vents inside the refrigerator.
 - If the air vents are blocked, especially with a plastic bag, the refrigerator can be over-cooled. If a cooling period lasts too long, the water filter may break and cause water leakage.
- If the refrigerator is disconnected from the power supply, you should wait for at least five minutes before plugging it back in.
- If large amounts of water enter the refrigerator, pull out the power plug and contact a Samsung service center.
- Do not strike or apply excessive force to any glass surface.
 - Broken glass may result in a personal injury and/or property damage.
- Fill the water tank and ice cube trays with potable water only (tap water, mineral water, or purified water).
 - Do not fill the tank with tea, juice, or a sports drink. They can damage the refrigerator.
- If the refrigerator is flooded, shut off the power to the refrigerator and contact your nearest Samsung service center.
 - There is a risk of electric shock or fire.
- Do not keep vegetable oil in your refrigerator's door bins. The oil can solidify, making it foul-tasting and difficult to use. In addition, the open container can leak and the leaked oil can cause the door bin to crack. After opening an oil container, it is best to keep the container in a cool and shaded place such as a cupboard or pantry.
 - Examples of vegetable oil: olive oil, corn oil, grape-seed oil, etc.

Safety information

Cleaning cautions

CAUTION

- Do not spray water directly on the inside or outside of the refrigerator.
 - There is a risk of fire or electric shock.
- Do not use a hair dryer to dry the inside of the refrigerator.
- Do not place a lighted candle in the refrigerator to remove bad odors.
 - This may result in an electric shock or fire.
- Do not spray cleaning products directly on the display.
 - Printed letters on the display may come off.
- If any foreign substance such as water has entered the appliance, unplug the power plug and contact your nearest Samsung service center.
 - Failing to do so may result in an electric shock or fire.
- Use a clean, dry cloth to remove any foreign matter or dust from the power plug blades. Do not use a wet or damp cloth when cleaning the plug.
 - Otherwise, there is a risk of fire or electric shock.
- Do not clean the appliance by spraying water directly onto it.
- Do not use benzene, thinner, or Clorox (bleach) to clean the refrigerator.
 - They may damage the surface of the appliance and may cause a fire.
- Never put fingers or any objects into the dispenser outlet.
 - This can cause a personal injury or material damage.
- Before cleaning or performing maintenance, unplug the appliance from the wall socket.
 - Failing to do so may result in an electric shock or fire.
- Use a clean sponge or soft cloth and a mild detergent in warm water to clean the refrigerator.
- Do not use abrasive or harsh cleansers such as window sprays, scouring cleansers, flammable fluids, muriatic acid, cleaning waxes, concentrated detergents, bleaches, or cleansers containing petroleum products on exterior surfaces (doors and cabinet), plastic parts, door and interior liners, and gaskets.
 - These can scratch or damage the material.
- Do not clean glass shelves or covers with warm water when they are cold. Glass shelves and covers may break if exposed to sudden temperature changes or impacts such as bumping or dropping.

Critical disposal warnings

WARNING

- Children trapped inside a refrigerator can hurt themselves or suffocate to death.
- Please dispose of the packaging material from this product in an environmentally friendly manner.
- Ensure that none of the pipes on the back of the refrigerator are damaged prior to disposal.
- This product contains R-600a, a flammable gas, which is used as the refrigerant. Contact your local authorities regarding safe disposal of this product.
- When disposing of this refrigerator, remove the door/door seals and door latch so that small children or animals cannot become trapped inside. Children should be supervised to ensure that they do not play with the appliance.
 - If trapped inside, the child could be injured or suffocate to death.
- Cyclopentane is used in the insulation. The gases in the insulation material require a special disposal procedure. Please contact your local authorities in regard to the environmentally safe disposal of this product.
- Keep all packaging materials well out of the reach of children, as packaging materials can be dangerous to children.
 - If a child places a bag over his or her head, the child could suffocate.

Installation

Follow these instructions carefully to ensure a proper installation of this refrigerator and to prevent accidents before using it.

WARNING

- Use the refrigerator only for its intended purpose as described in this manual.
- Any servicing must be performed by a qualified technician.
- Dispose of the product packaging material in compliance with the local regulations.
- To prevent electric shock, unplug the power plug before servicing or replacing parts.

Refrigerator at a glance

The actual refrigerator and provided parts of your refrigerator may differ from the illustrations in this manual, depending on the model and the country.

Type A

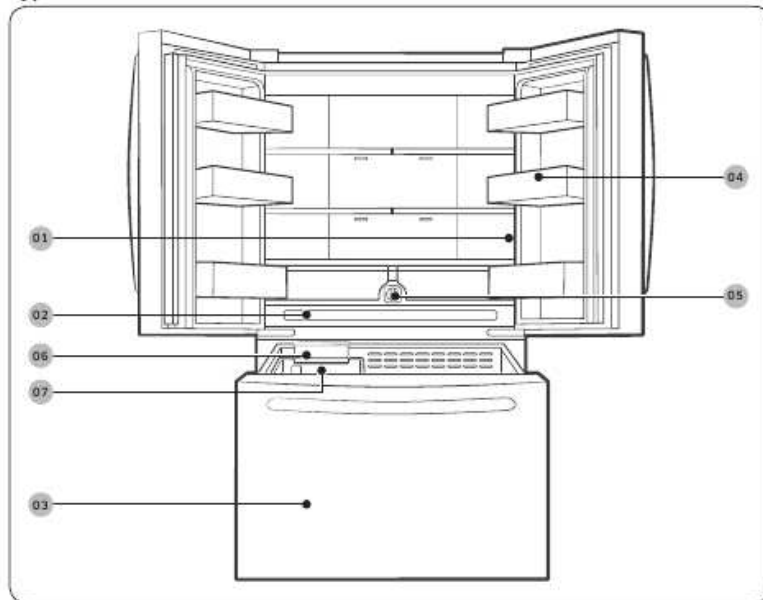

Type B

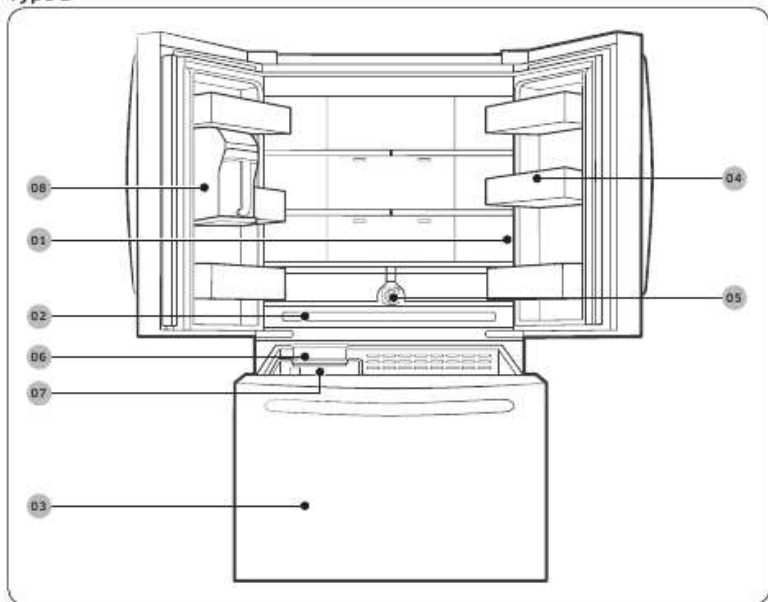

Installation

Installation

Type C

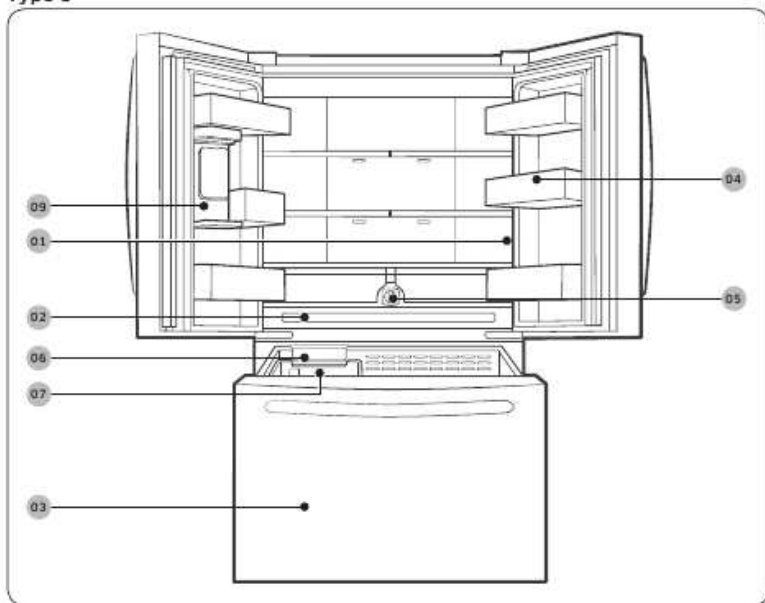

Installation

Type D

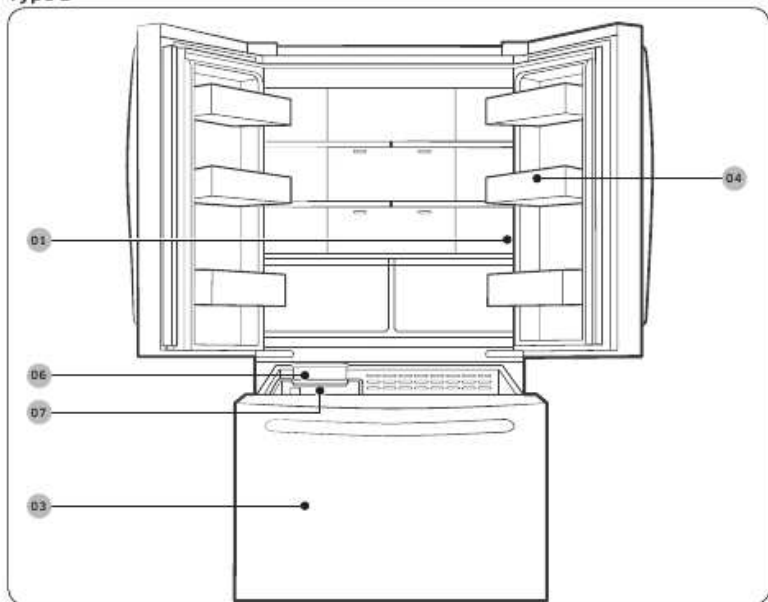

Installation

Installation

- 01 Main panel
- 02 Wide Pantry *
- 03 Freezer
- 04 Door bins
- 05 Water filter *
- 06 Ice Maker *
- 07 Ice bucket *
- 08 AutoFill Pitcher *
- 09 Inner dispenser *

* applicable models only

NOTE

- For energy efficiency, keep all shelves, drawers, and baskets in their original positions.
- When closing the door, make sure the vertical hinged section is in the correct position to avoid scratching the other door.
- If the vertical hinged section is reversed, put it back into the correct position, and then close the door.
- Moisture may form at times on the vertical hinged section.
- If you close a door forcefully, the other door may open.
- If the internal or external LED lamp is out of order, contact a local Samsung service center.
- If the door is left open for too long, the top internal LED will blink. This is normal.

Step-by-step installation

STEP 1 Select a site

Select a site that:

- Has a solid, level surface without carpeting or flooring that may obstruct ventilation
- Is away from direct sunlight
- Has adequate room for opening and closing the door
- Is away from any heat sources
- Provides room for maintenance and servicing
- Has a temperature range between 50 °F (10 °C) and 109 °F (43 °C)

CAUTION

- If your refrigerator is equipped with an ice maker, provide extra space at the rear of the refrigerator for the water line connection.
- When you install the refrigerator next to a fixed wall, you must provide a minimum clearance of 3 1/4" (95 mm) from the wall to allow the door to swing open.

NOTE

To facilitate moving your refrigerator to its final location, be sure to measure the width and height of doorways, thresholds, ceilings, stairways, and anything else that needs to be taken into consideration to ensure you can move your refrigerator safely. The following diagram illustrates the exact height and depth (factory specifications) of your refrigerator.

Installation

Clearance

See the following figures and tables for space requirements for installation.

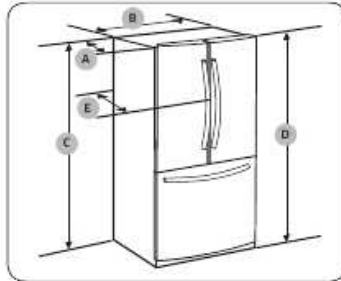

Model	RF28*
Depth "A"	32 7/8" (836 mm)
Width "B"	35 3/4" (908 mm)
Height "C"	68 7/8" (1749 mm)
Overall Height "D"	70" (1777 mm)
Depth "E"	35 3/8" (898 mm)

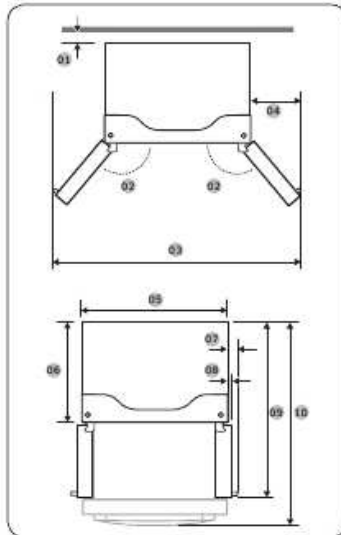

Model	RF28*
01	2" (50 mm)
02	130"
03	62 2/8" (1581 mm)
04	13 2/8" (337 mm)
05	35 3/4" (908 mm)
06	28 7/8" (735 mm)
07	3 3/8" (93 mm)
08	1 7/8" (47 mm)
09	47 2/8" (1201 mm)
10	51 7/8" (1318 mm)

NOTE

The measurements in the table above may differ slightly from the actual measurements, depending on the measuring and rounding method.

STEP 2 Flooring

If the refrigerator cannot pass through the entrance due to its size, see **STEP 3 Door removal for entrance**.

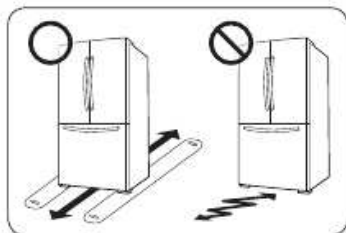

NOTE

To prevent floor damage, make sure the front leveling legs are in the upright position.

- The surface you install the refrigerator on must support a fully loaded refrigerator.
- To protect the floor, put a large piece of cardboard along the path to the refrigerator's final installation location.
- Once the refrigerator is in its final position, do not move it unless necessary to protect the floor. If you have to move the refrigerator, place thick paper or cloth such as old carpets along the path of movement.

Installation

STEP 3 Door removal for entrance

If the refrigerator cannot pass through the entrance to your home or kitchen due to its size, follow these instructions to remove and then re-install the refrigerator's doors. If you do not need to remove the doors, go to page 29 to continue the installation procedure.

WARNING

Unplug the power cord of the refrigerator before removing the doors.

Tools required (not provided)

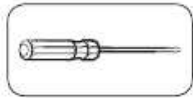

Phillips screwdriver

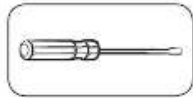

Flat-head screwdriver

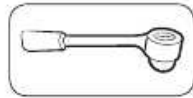

Socket wrench 3/8" (10 mm)

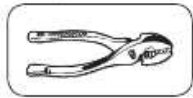

Pliers



Allen wrench 1/4" (5 mm)

Detach the fridge doors

Left door

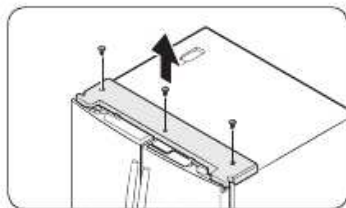

1. With the doors closed, use a Phillips head screwdriver to remove the screws (x3) in the top cover.

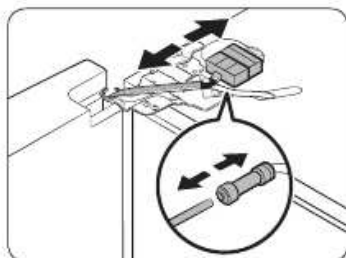

2. Disconnect the wires and the water tube from the left-side door. Do the following sequentially:
 - Decouple the **connector**.
 - While holding down one end of the water line coupler, disconnect the **water tube**.

CAUTION

Keep the water tube clips out of children's reach.

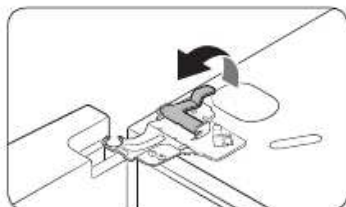

3. Gently draw up the clamp. To prevent finger injuries, do not apply a sudden force to the clamp.

Installation

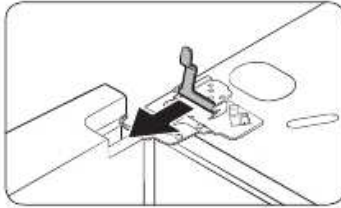

4. Pull the clamp to remove it:

NOTE

Be careful not to drop the clamp on the floor.

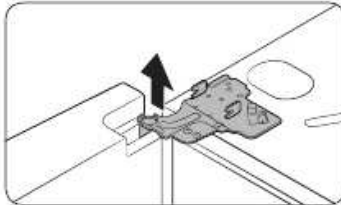

5. Open the door 90 degrees. While holding the door, pull up and remove the top hinge. Be careful not to damage the connector wires when you remove the hinge.

NOTE

Be careful not to drop the hinge on the floor.

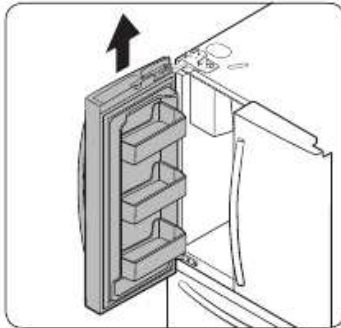

6. Gently pull up the door vertically to remove. Do not apply excessive force to the door. The door may fall, causing physical injury.
7. Lay the door down on a flat surface.

CAUTION

Please put the door down slowly to prevent scratches.

Right door

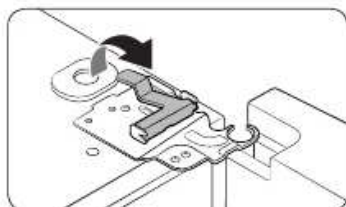

1. Gently draw up the clamp. To prevent finger injuries, do not apply a sudden force to the clamp.

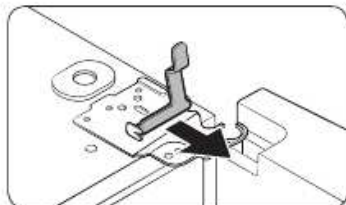

2. Pull the clamp to remove it.

NOTE

Be careful not to drop the clamp on the floor.

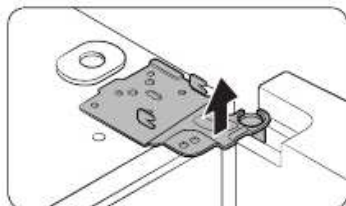

3. Open the door 90 degrees. While holding the door, pull up and remove the top hinge. Be careful not to damage the connector wires when you remove the hinge.

NOTE

Be careful not to drop the hinge on the floor.

Installation

Installation

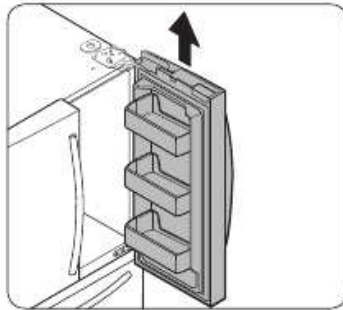

4. Gently pull up the door vertically to remove. Do not apply excessive force to the door. The door may fall, causing physical injury.
5. Lay the door down on a flat surface.

To reattach the fridge door

After you have moved the refrigerator to its final location, reattach the doors by following the removal instructions in reverse order.

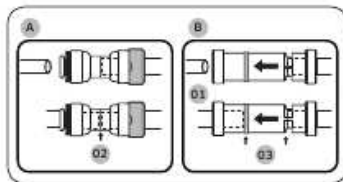

- 01 Dispenser
- 02 Center of transparent coupler
- 03 Guidelines

CAUTION

To prevent water leaks from the dispenser, the water line must be fully connected. Make sure both tubes of the water line are inserted fully to the center of transparent coupler (A) or the guidelines (B).

To detach the freezer drawer

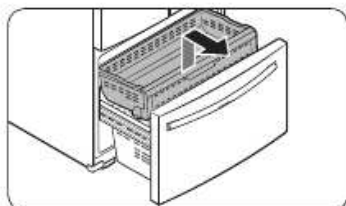

1. Lift up the front of the **upper basket** and pull to remove.

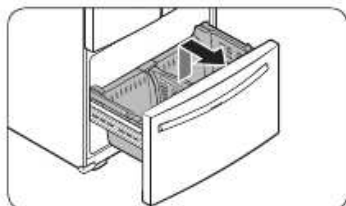

2. Then, pull up to remove the **lower basket** from the rail assembly.

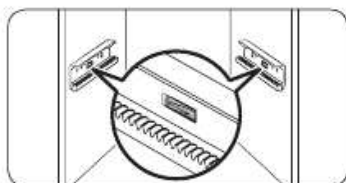

3. Press down the hooks to unlock the rail assembly.

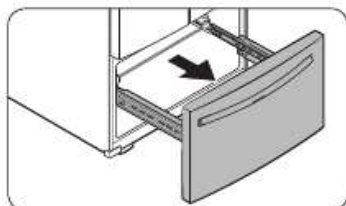

4. While holding the upper area of the freezer drawer front, slide the drawer out all the way to remove the freezer drawer from the rail assembly.

Installation

Installation

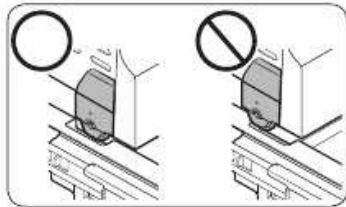

CAUTION

- Be careful not to scratch or dent the rail assembly.
- Make sure you mount the freezer baskets in the correct position. Otherwise, the door will not open or close properly, which causes frost to build up.
- Do not store too much food in the freezer drawer. This prevents the freezer drawer from closing properly, resulting in frost buildup.

To reattach the freezer drawer

Once the refrigerator is in or near its final location, re-attach the freezer drawer by following the directions in the reverse order of removal.

STEP 4 Leveling the refrigerator

CAUTION

- When installed, the refrigerator must be leveled on a flat, solid floor. Not leveling the refrigerator can cause damage to the refrigerator or physical injury.
- Leveling must be performed with the refrigerator empty. Make sure no food items are inside the refrigerator.
- For safety reasons, adjust the front a little higher than the rear.

Level the refrigerator using the special screws (levelers) on the front legs. Use a flat-head screwdriver to turn the levelers.

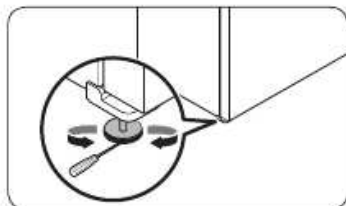

- To adjust the height of the left side: Insert a flat-head screwdriver into the leveler of the left side front leg. Turn the leveler clockwise to raise the left side or turn it counterclockwise to lower.
- To adjust the height of the right side: Insert a flat-head screwdriver into the leveler of the right side front leg. Turn the leveler clockwise to raise the right side or turn it counterclockwise to lower.

Installation

STEP 5 Adjust the door height and the door gap

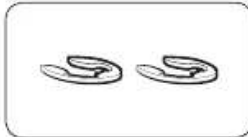

Snap rings

The height of a door can be adjusted using the provided snap rings, which come in 4 different sizes (1 mm, 1.5 mm, 2 mm, and 2.5 mm).

To adjust the height of a door

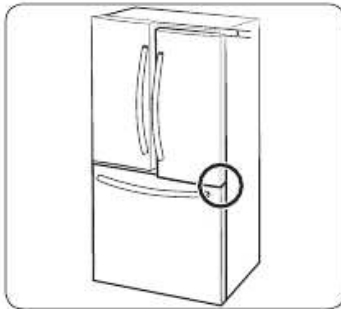

1. Check the height difference between the doors, and then lift up and hold the door with the lower height.

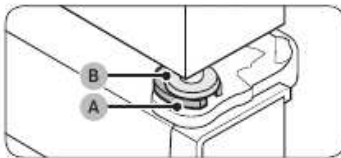

2. Insert a suitable-sized snap ring (A) between the door grommet (B) and the hinge as shown.

⚠ CAUTION

- Insert only one snap ring. If you insert two or more snap rings, the rings may slip out or make a rubbing noise.
- Keep the snap rings out of children's reach and keep them for future use.
- Do not raise the door too much. The door can contact and damage the top cover.

STEP 6 Attach the handles

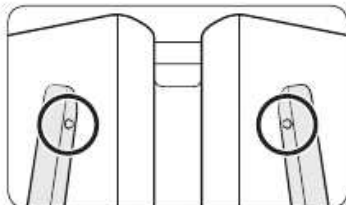

CAUTION

The refrigerator handles must be oriented in the correct direction.

- The fridge handles must be attached so that the holes on each face each other.
- The freezer handle must be attached so that its hole faces downwards.

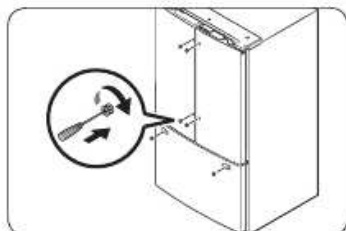

1. Using a Phillips screwdriver, attach the handle screws to the refrigerator, two for each handle respectively, as shown in the illustration to the left.

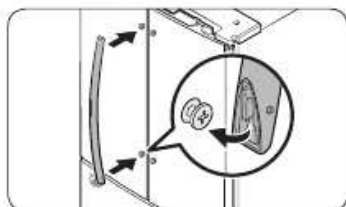

2. Attach the handle to the handle screws on the door.

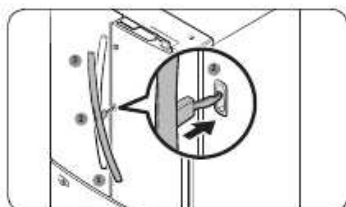

For type B handle: Insert the hook on the middle of the handle to its designated hole on the door, and then place the upper and lower part of the handles to the handle screws.

NOTE

The design of the right side door handle may differ depending on your model.

Installation

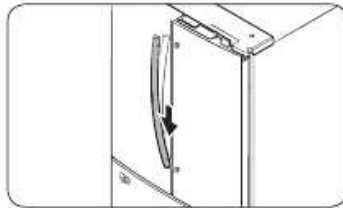

3. Push the handle down.

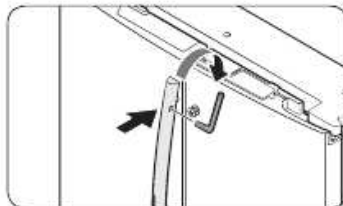

4. Insert an Allen wrench into the handle hole, and then turn it clockwise to tighten.

5. Repeat Steps 2 through 4 with the second refrigerator door handle.

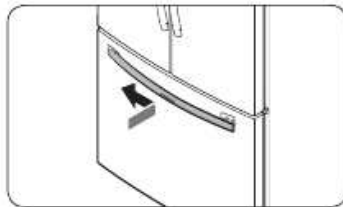

6. To attach the freezer handle to the refrigerator, first place the left side of the freezer handle onto the left handle screw, and then push it to the left.

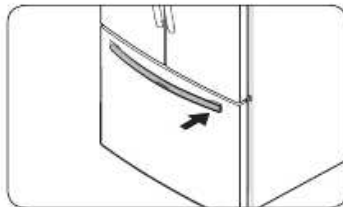

7. Then, place the right side of the freezer handle onto the right handle screw.

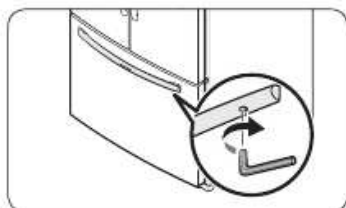

8. Insert an Allen wrench into the handle hole, and then turn it clockwise to tighten.

Installation

Installation

STEP 7 Connect the water dispenser line (applicable models only)

A water dispenser with a filter is one of the helpful features on your new refrigerator. To help promote better health, the water filter removes unwanted particles from your water. However, it does not sterilize or destroy microorganisms. You may need to purchase a water purifying system to do that.

The water line also connects to the ice maker. For the ice maker to operate properly, water pressure of 30 to 120 psi (206 to 827 kPa) psi is required.

If the refrigerator is installed in an area with low water pressure (below 30 psi / 206 kPa), you can install a booster pump to compensate for the low pressure.

After you have connected the water line, make sure the water storage tank inside the refrigerator is properly filled. To do this, press the water dispenser lever until water runs from the water outlet.

NOTE

- Water line installation kits are available at extra cost from your retailer. We recommend using a water line installation kit that contains copper tubing and a 1/4" (6 mm) compression nut.

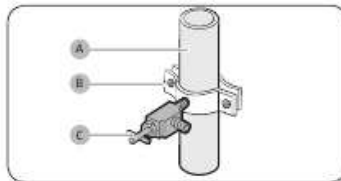

1. Shut off the main water source.
2. Insert the pipe clamp (B) and the shutoff valve (C) into the cold water line (A).

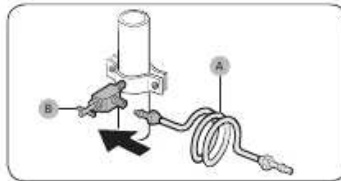

3. Connect the water line installation kit (A) to the shutoff valve (B).

Connect the water supply line to the refrigerator:

There are several items you must purchase to complete this connection. You may find these items sold as a kit at your local hardware store.

Copper Tubing	<ul style="list-style-type: none">• 1/4" copper tubing• 1/4" compression nut (1 pc)• Ferrule (2 pc)
Plastic Tubing	<ul style="list-style-type: none">• 1/4" plastic tubing → Molded end (Bulb)• 1/4" compression nut (1 pc)

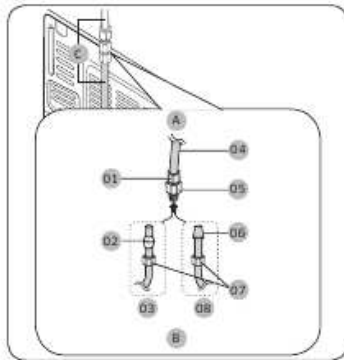

- A. Refrigerator
- B. Household water supply line
- C. Water Line: must be kept straight.

- 01 Compression Nut (1/4") (Assembled)
- 02 Ferrule (Not supplied)
- 03 Copper tubing (Not supplied)
- 04 Plastic Tubing (Assembled)
- 05 Compression Fitting (Assembled)
- 06 Molded end (Bulb)
- 07 Compression nut (1/4") (Not supplied)
- 08 Plastic Tubing (Not supplied)

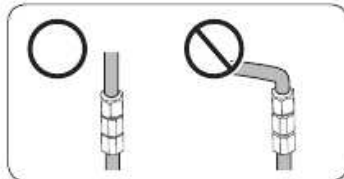

NOTE

If you have to relocate the refrigerator after connecting the **water line (C)**, make sure the joined section of the water line is straight.

Installation

Installation

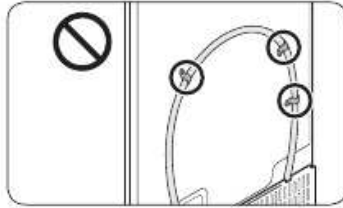

⚠ CAUTION

Do not mount the water filter on any part of the refrigerator. This may damage the refrigerator.

1. Connect the household water line to the assembled compression fitting.
 - If you are using copper tubing, slip the **compression nut (07)** (not supplied) and **ferrule** (not supplied) on the copper tubing (not supplied) as shown.
 - If you are using **plastic tubing (08)**, insert the molded end (Bulb) of the **plastic tubing (08)** into the compression fitting.

⚠ CAUTION

- If you use **plastic tubing (08)**, do not use it without the molded end (Bulb).
 - Leaving the water line disconnected may cause the water valve to produce a buzzing sound over time. If this is the case, make sure that the ice making function is turned "OFF" and do not attempt to use the water dispenser.
2. Tighten the **compression nut (07)** onto the **compression fitting**. Do not over-tighten the **compression nut (07)**.
 3. Turn the water on and check for any leakage. If you find water drops or leakage in the connection areas, turn off the main water supply. Check the connections and, if necessary, tighten.
 4. Flush 1 gallon of water through the filter before drinking or using the water from the refrigerator. (Flush approximately 6 minutes.) To flush, press a large glass or cup against the water dispenser lever. Fill the glass, empty it, and then repeat.
 5. After you turn on the refrigerator, let the ice maker make ice for 1 to 2 days. Over that period of time, throw out the first 1 or 2 buckets of ice the ice maker makes to ensure all impurities have been removed from the water line.

📌 NOTE

Only connect the water line to a potable water source.

- If you have to repair or disassemble the water line, cut off $\frac{1}{4}$ " of the plastic tubing to make sure you get a snug, leak-free connection.
- You can test the water line quickly using a paper cup. Under normal conditions, the water dispenser can fill a $5\frac{3}{4}$ oz. (170 cc) cup in about 10 seconds.

STEP 8 Initial settings

By completing the following steps, the refrigerator should be fully functioning.

1. Plug the power cord into the wall socket to turn the refrigerator on.
2. Open the door, and check if the interior light lights up.
3. Set the temperature to the coldest setting, and wait for about an hour. Then, the freezer will be slightly chilled, and the motor should be running smoothly.
4. Wait until the refrigerator reaches the set temperature. Now the refrigerator is ready for use.

STEP 9 Final check

When installation is complete, confirm that:

- The refrigerator is plugged into an electrical outlet and grounded properly.
- The refrigerator is installed on a flat, level surface with a reasonable clearance from walls and cabinets.
- The refrigerator is level and is sitting firmly on the floor.
- The door opens and closes freely, and the interior light turns on automatically when you open the door.

Operations

Main panel

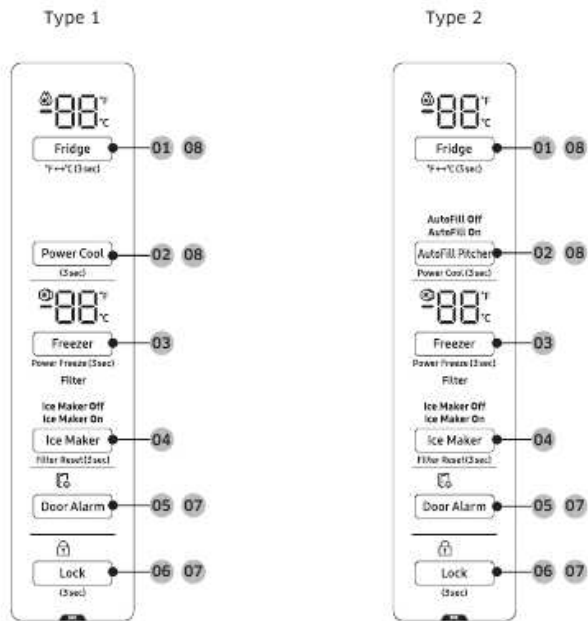

01 Fridge / °F ↔ °C

03 Freezer / Power Freeze

05 Door Alarm

07 Sabbath Mode

* applicable models only

02 Power Cool / AutoFill Pitcher *

04 Ice Maker / Filter Reset *

06 Lock

08 Cooling Off

NOTE

- When you change the temperature on the panel, the panel displays the actual temperature inside the refrigerator until the temperature matches the temperature you set. Then, the panel displays the new set temperature. Note that it will take time for the refrigerator to reach the new temperature. This is normal. During this time, you do not need to set the temperature again.
- To ensure optimal performance, we recommend setting the temperature to 0 °F (-18 °C) for the freezer, and 37 °F (3 °C) for the fridge.
- The temperature in the refrigerator may rise if you open the door frequently or put a large amount of food into the refrigerator. If this happens, the temperature display blinks until the refrigerator returns to the specified temperature settings. If the blinking continues for an extended time, contact a local Samsung service center for technical assistance.
- The display of the main panel turns on only if the door is opened and turns off if the door is closed.
- If you set the Lock function on the main panel, the main panel locks automatically 1 minute after inactivity.

01 Fridge / °F ↔ °C (3 sec)

Fridge	You can use the Fridge button to set the fridge temperature. <ul style="list-style-type: none">• Press Fridge repeatedly to select a desired temperature between 34 °F (1 °C) and 44 °F (7 °C).<ul style="list-style-type: none">- The temperature indicator displays the current temperature or selected temperature.
°F ↔ °C	You can also use the Fridge button to switch the temperature scale between Celsius and Fahrenheit. To switch the temperature scale, press and hold Fridge for 3 seconds to change the current temperature scale.

02 Power Cool (3 sec) / AutoFill Pitcher

Power Cool	Power Cool speeds up the cooling process at maximum fan speed. This is useful to quickly cool food that spoils quickly, or after the door is left open for some time. The fridge keeps running at full speed for several hours and then returns to the previous temperature. Press and hold Power Cool for 3 seconds. Press and hold Power Cool (or AutoFill Pitcher for RF28T502*** model) for 3 seconds. The corresponding indicator () lights up, and the refrigerator will speed up the cooling process for you.
------------	---

Operations

AutoFill Pitcher (RF28T502*** model only)

If the Lock indicator (🔒) is off, press **AutoFill Pitcher** turn AutoFill Pitcher on. Then, open the left door of the fridge and insert the water tank. Close the door and the water tank starts to fill with water up to the preset level.

If the Lock Indicator (🔒) is on, indicating the Lock function is active, press and hold **Lock** for 3 seconds to deactivate the Lock function. When the Lock indicator turns off, immediately press **AutoFill Pitcher** to turn AutoFill Pitcher on. Then, open the left door of the fridge and insert the water tank. Close the door and the water tank starts to fill with water up to the preset level.

NOTE

- When you turn off the Lock function, you must press **AutoFill Pitcher** within one minute or the Lock function will automatically reactivate. You cannot turn the AutoFill Pitcher function on if the Lock function is active. For more information on the Lock function, see page 43. To turn the function off, press the **AutoFill Pitcher** again.
- By default, AutoFill Pitcher is disabled. Enable this function after you have installed the water line.
- **AutoFill Off** blinks if you open the door and remove or insert the pitcher with the AutoFill Pitcher function off. To stop the blinking, close the door or, turn the AutoFill Pitcher function on.
- The AutoFill Pitcher indicators (**AutoFill On / AutoFill Off**) blink if there is a leak. If this is the case, follow these steps.
 - a. Open the rubber cap and drain water.
 - b. When draining is complete, the indicators stop blinking and turn solid.
 - c. Close the rubber cap.
- If the indicators continue to blink, this might be a system failure. Contact a local service center.

03 Freezer / Power Freeze (3 sec)

Freezer	The Freezer button can be used to set the freezer temperature, or to activate Power Freeze. Available temperatures are between 5 °F (-15 °C) and -8 °F (-23 °C).
Power Freeze	<p>Power Freeze speeds up the freezing process at maximum fan speed. The freezer keeps running at full speed for 50 hours and then returns to the previous temperature.</p> <ul style="list-style-type: none">• To activate Power Freeze, press and hold Freezer for 3 seconds. The corresponding indicator (❄️) lights up, and the refrigerator will speed up the freezing process for you.• To deactivate, press and hold Freezer for 3 seconds again. The freezer returns to the previous temperature setting.• To freeze large amounts of food, activate Power Freeze for at least 20 hours before putting food in the freezer. <p>NOTE Using Power Freeze increases power consumption. Make sure you turn it off and return to the previous temperature if you do not intend to use it.</p>

Operations

04 Ice Maker / Filter Reset (3 sec)

Ice Maker	<p>Press Ice Maker to turn the ice maker on or off.</p> <p>The ice maker has 2 indicators (Ice Maker On / Ice Maker Off) to indicate its operating status.</p> <ul style="list-style-type: none">• When the ice maker operates, the corresponding indicator (Ice Maker On) turns on.• When the ice maker is turned off, the corresponding indicator (Ice Maker Off) turns on. To enable ice making, you must turn the ice maker on.
Filter Reset	<p>After about 6 months (and typically, about 300 gallons (1200 L) of water), the Filter indicator blinks red for several seconds when you open the door, reminding you that the filter needs to be replaced. When this happens, replace the filter, and then press and hold Ice Maker for 3 seconds. The filter lifecycle will be reset and the Filter indicator turns off.</p> <p>NOTE</p> <ul style="list-style-type: none">• Some regions have relatively large amounts of lime in their water. This can reduce the lifecycle of the filter. In these areas, you will have to replace the water filter more often than specified above.• If water is not dispensing properly, the water filter is most likely clogged. Replace the water filter.

05 Door Alarm

Door Alarm	If the door is left open for more than 2 minutes, an alarm will sound and the alarm indicator will blink. You can toggle the alarm on and off by pressing Door Alarm . The alarm is enabled by factory default. If the door is left open for 5 minutes, internal lights (in the fridge and freezer) will blink for 10 seconds and then turn on. The whole process will be repeated every minute for 5 minutes. This is to alert hearing-impaired users that a door is open. Note that this function is normal.
------------	---

06 Lock (3 sec)

Lock	To prevent accidental setting changes, press and hold Lock for 3 seconds. The main panel will be disabled and the Lock indicator () will turn on. When the Lock function is on, the indicator blinks if any button on the main panel is pressed. If you press and hold the button again for more than 3 seconds, the Lock function will be deactivated. However, the Lock function will be reactivated if no button is pressed within 1 minute.
------	---

Operations

07 Sabbath Mode

The Sabbath mode stays active for 85 hours once it is activated. After that, it will be deactivated automatically.

- To activate Sabbath Mode, press and hold **Door Alarm** and **Lock** simultaneously for 5 seconds. When the refrigerator is in Sabbath mode, the buttons, the display, and the internal lights do not function. The refrigerator and freezer, however, continue to cool.
- To deactivate Sabbath Mode, press and hold **Door Alarm** and **Lock** simultaneously again for 5 seconds.

NOTE

- If the refrigerator powers off and restarts (for example, if there is a power failure), the Sabbath mode remains active. To end Sabbath Mode, you must deactivate it as described above.
- Controls must be unlocked before activating Sabbath mode.

08 Cooling Off

Cooling Off mode (also called Shop mode) is designed for use by retailers when they are displaying refrigerators on a retail floor.

In Cooling Off mode, the refrigerator's fan motor and lights operate normally, but the compressors do not run so neither the refrigerator nor the freezer become cold.

To enter or exit the Cooling Off mode, press and hold **Fridge** and **Power Cool** (or **Fridge** and **AutoFill Pitcher** for RF28T502*** model) simultaneously for 6 seconds. Then, when the display blinks, press **Lock**.

When the Cooling Off mode is on, the refrigerator chime sounds, and the refrigerator shows "0" on the fridge temperature display and "FF" on the freezer temperature display.

Special features

Water pitcher (AutoFill Pitcher) (applicable models only)

The AutoFill Pitcher function lets you enjoy cold brewed tea in your refrigerator.

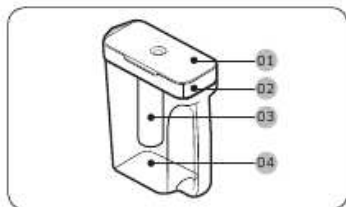

- 01 Lid
- 02 Sealed mouth
- 03 Infuser
- 04 Body

To fill the Water pitcher

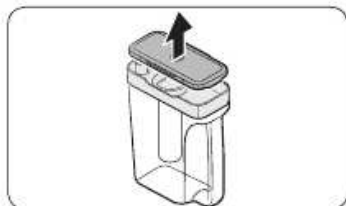

1. Grasp a handle groove of the **sealed mouth**, and then pull up to open the **lid**.
2. Put tea leaves or fruit to your taste into the infuser.

NOTE

If you want to keep the infused water in its initial concentration, turn the AutoFill Pitcher function off.

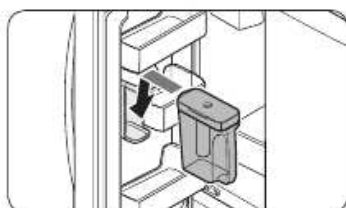

3. Enable the AutoFill Pitcher function on the main panel. Open the left door of the fridge door, and then mount the water pitcher onto the holder. Push it straight in as shown in the illustration on the left.
4. Close the door. The water pitcher will start to fill with chilled water a short time later.

CAUTION

Make sure the water pitcher fits in the water pitcher holder.

Operations

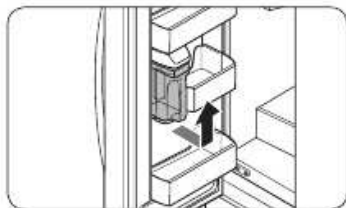

5. To drink tea, open the door and detach the water pitcher. Pull it straight out.

⚠ CAUTION

- We recommend consuming fruit infused water within 24 hours. After that, the infused water can spoil over time.
- You must clean the water pitcher after you have consumed the infused water. Also clean the water pitcher if you haven't used it for a long time.

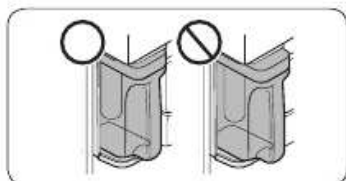

- To prevent the water pitcher from tipping over or leaking, make sure the water pitcher fits in the water pitcher holder.

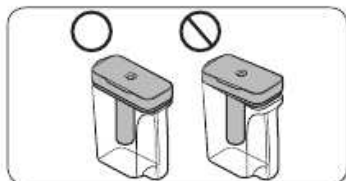

- To prevent the water pitcher from spilling over or leaking, make sure the **sealed mouth** is properly inserted.

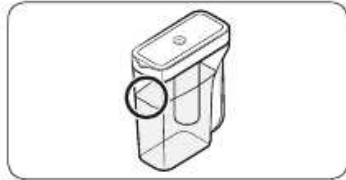

NOTE

- If the front side (specifically marked area) of the water pitcher has too much moisture, the water pitcher may not fully fill. Remove the moisture, and then try again.
- The AutoFill Pitcher function will stop supplying water to the water pitcher if the water pitcher does not fill after a certain amount of time. If this happens, check if the water line is properly connected. Remove and reinsert the water pitcher, and then try again.

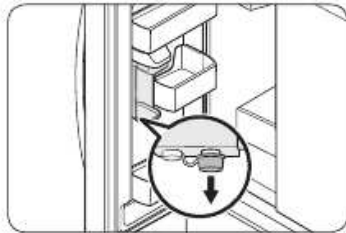

NOTE

- Wipe around the infuser holder if the infuser overflows or leaks.
- Water drops off if the rubber cap is opened.
- The AutoFill Pitcher indicator (**AutoFill On / AutoFill Off**) blinks if there is a leak. In case of a leak, open the rubber cap so that the leaked water drains. The indicator will then turn off. However, if the indicator continues to blink, there might be a system failure. Contact your local Samsung service center.
- The AutoFill Pitcher indicators (**AutoFill On / AutoFill Off**) blink if there is a leak. See page 39 for more information.
- **AutoFill Off** blinks if you open the door and remove or insert the pitcher with the AutoFill Pitcher function off. To stop the blinking, close the door or, turn the AutoFill Pitcher function on.

Operations

Inner dispenser (applicable models only)

To dispense chilled water, put a water glass under the dispenser, and then push the dispenser lever.



NOTE

- The dispenser will stop dispensing if you keep pushing the dispenser lever for about 1 minute. To dispense more water, release and push the lever again.
- Make sure the glass is in line with the dispenser to prevent the dispensed water from spilling out.
- If you do not use the water dispenser for 2-3 days, the dispensed water may have an abnormal smell or taste. This is not a system failure. Discard the first 1-2 glasses of water.
- Do not put cups or other containers on the water tray under the inner dispenser as they may fall on the floor.

Ice maker

The refrigerator has a built-in ice maker that automatically dispenses ice so that you can enjoy filtered water with cubed or crushed ice.

Ice making

After you have installed your refrigerator and plugged it in, follow these instructions to ensure proper ice making and to keep the ice bucket full of ice:

1. Let the refrigerator operate for at least 24 hours to ensure optimal performance.
2. Dispense the first 4 to 6 ice cubes into a glass.
3. Wait another 8 hours and dispense another 4 to 6 ice cubes.
4. Then, wait another 16 hours and dispense the first glass-full of ice.

NOTE

- If you consume all the ice at once, you must wait 8 hours before dispensing the first 4 to 6 cubes. This ensures that the ice bucket is filled with ice properly.
- Ice cubes generated rapidly may look white, which is normal.

Diagnosis

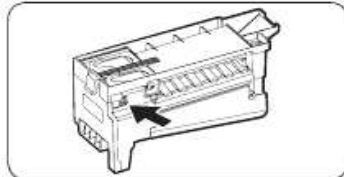

If ice does not dispense, first check the ice maker.

1. Press **Test** on the side of the ice maker. You will hear a chime (ding-dong) when you press the button.
2. You will hear another chime if the ice maker is operating properly.

⚠ CAUTION

- If the ice making chime rings repeatedly, contact your waterline installer or a local Samsung service center.
- Do not press **Test** repeatedly after the ice tray is filled with ice or water. Water may overflow or ice may jam.
- Do not put food in the ice bucket. The frozen food may damage the ice maker, especially when you open or close the door.
- When the refrigerator recovers power after a power failure, the ice bucket may contain a mix of melted and jammed ice cubes, which can prevent the ice maker from working properly. To prevent this, make sure to empty the ice bucket so the ice bucket can refill with fresh, loose ice cubes.
- Do not put fingers or any objects into the dispenser outlet or the ice maker. This can cause physical injury or property damage.
- When reinserting the ice maker tray, make sure that the tray is properly centered at the entrance. Otherwise, the tray can get stuck.

If You Turn the Ice Maker Off

If you press and hold **Ice Maker** for more than 3 seconds to turn the ice maker off, make sure to remove all ice cubes from the ice bucket. Remaining ice cubes may clump together, making it difficult to remove them.

📌 NOTE

- Removal of the ice bucket does not affect the thermal and mechanical performance of the refrigerator.

Water clouding

Water supplied to the refrigerator flows through a core alkaline filter. During this filtering process, the water pressure of the water increases and the water becomes saturated with oxygen and nitrogen. This causes the water to look misty or cloudy temporarily when dispensed. This is normal and the water will look clear after a few seconds.

Maintenance

Handling and care

Fridge shelves

The appearance of the shelves differs by model.

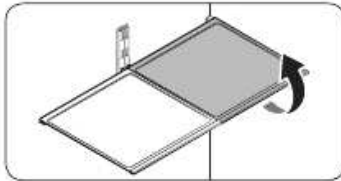

- To remove a shelf, fully open the corresponding door. Hold the front of the shelf, and then gently lift up and slide out.

NOTE

Do not lift up the shelf fully when removing or reinserting the shelf. The rear wall of the fridge room can be dented.

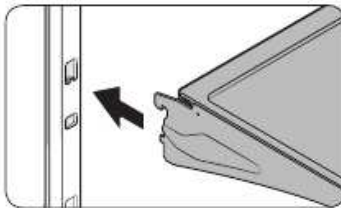

- To reinsert, hold the shelf at an angle so the front is higher than the back, and then insert the top hook into the top shelf notch. Then, lower the shelf and insert the bottom shelf hook into the bottom shelf notch.

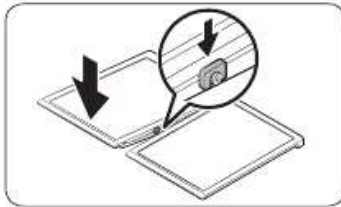

CAUTION

- The tempered glass shelves are heavy. Use caution when removing them.
- The shelf must be inserted correctly. Do not insert upside down.
- Glass containers may scratch the surface of glass shelves.

Door bins

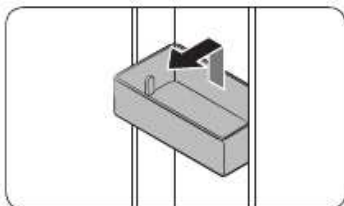

- To remove the **door bin**, hold the front sides of the bin, and then gently lift up to remove.
- To reinsert, insert the **door bin** slightly above its final location making sure that the back of the bin is against the door. Hold the rear of the **door bin** with both hands, and then press down so that it fits snugly.

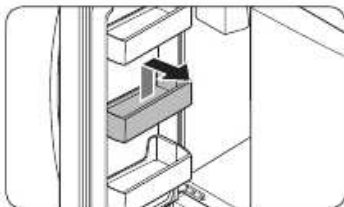

CAUTION

- Do not remove a bin that is filled with food. Empty the bin beforehand.
- Use caution when opening the door if the bottom bin contains larger bottles, which may fall over.
- Do not allow children to play with the bins. Sharp corners of the bin may cause injury.

Fridge drawers

Vegetable / fruit drawers

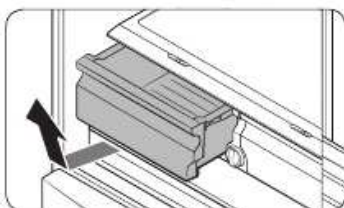

Gently lift up the front of the drawer and slide out.

- We recommend that you remove the door bins before removing the drawer. This is to prevent damage to the door bins.
- To reinsert, insert the drawer into the frame rails and then slide inward.

Maintenance

Wide Pantry (applicable models only)

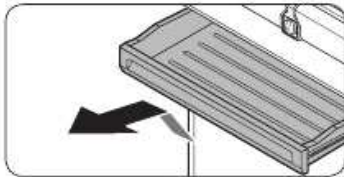

- To remove, fully open the Wide Pantry. Then, slightly lift the front side and pull straight out.
- To reinsert, push the rails to the back of the refrigerator. Then, place the Wide Pantry onto the rails and slide it back until it is in place.

Freezer baskets

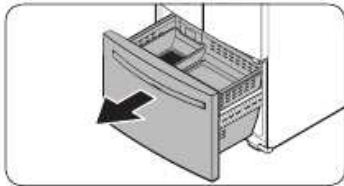

1. Fully open the freezer drawer.

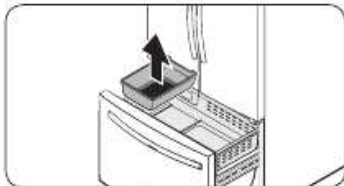

2. Lift the ice bucket to remove.

Upper basket

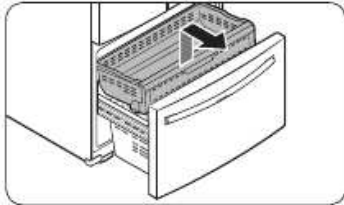

- To remove, fully slide open the freezer drawer. Lift up the front of the **upper basket** and pull to remove.
- To reinsert, align the front wheels of the **upper basket** with the end of the **lower basket**. Slide the **upper basket** to the front.

Lower basket

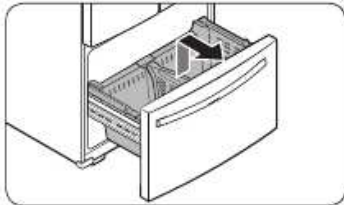

- To remove, first remove the **upper basket**. Then, tilt up the front of the **lower basket** to pull out.
- To reinsert, put the basket onto the **rail assembly** rear side first.

CAUTION

- Do not twist the basket when removing or reinserting the basket. The basket can be scratched.
- To prevent physical injury, property damage, or suffocation, keep children away from freezer baskets that have been removed.
- Do not remove the divider.
- Put the wheels of the upper basket on the end of the rails of the lower basket. Then, slide the upper basket all the way to the front. Otherwise, the drawer will not open or close properly, which will cause frost to build up.

Maintenance

Cleaning

Interior and exterior

WARNING

- Do not use benzene, thinner, home/car detergent, or Clorox™ to clean the refrigerator. They may damage the surface of the refrigerator and cause a fire.
- Do not spray water onto the refrigerator. This may cause electric shock.

Regularly use a dry cloth to remove all foreign substances such as dust or water from the power plug terminals and contact points.

1. Unplug the power cord.
2. Use a moistened, soft, lint-free cloth or paper towel to clean the refrigerator's interior and exterior.
3. When done, use a dry cloth or paper towel to dry well.
4. Plug in the power cord.

Rubber seals

If the rubber seals of a door become dirty, the door may not close properly and reducing refrigerator performance and efficiency. Use a mild detergent and damp cloth to clean the rubber seals. Then, dry well with a cloth.

Rear panel

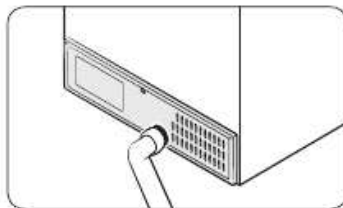

To keep cords and exposed parts of the rear panel free of dirt, vacuum the panel once or twice a year.

CAUTION

Do not remove the rear panel cover. Electric shock may occur.

Replacement

Water filter

WARNING

- Do not use third-party water filters. Use only Samsung-provided or -approved filters.
- Unapproved filters may leak and damage the refrigerator, causing electric shock. Samsung is not responsible for any damage that may occur from use of third-party water filters.

The Filter Reset indicator (**Filter**) turns red to let you know it is time to replace the water filter. Before replacing the filter, make sure the water supply line is shut off.

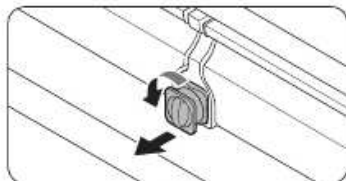

1. Shut off the water supply line.
2. Turn the knob of the filter cartridge 90 degrees counterclockwise (1/4 turn). The filter cartridge unlocks.

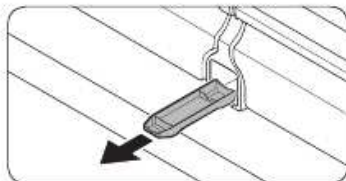

3. Pull out to remove the cartridge.
 - If the water filter is severely contaminated, the cartridge may not be easy to remove. If that is the case, use force to remove the cartridge.
 - To prevent water leaks from the filter opening, pull the cartridge straight out while removing it.

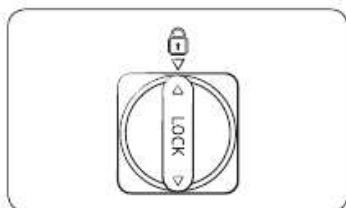

4. Insert a new filter cartridge. Use only Samsung-provided or approved filters.
5. Turn the cartridge knob clockwise to lock into place.
6. Press and hold **Ice Maker** on the main panel for 3 seconds to reset the life cycle detector. The Filter Reset indicator (**Filter**) turns off.

NOTE

For type A model (RF28T5000***) discard first 2 buckets of ice after changing the filter.

Maintenance

Reverse osmosis water filtration system

The water pressure of the water supply system to a reverse osmosis water filtration system must be between 30 to 120 psi (206 to 827 kPa).

The water pressure of the reverse osmosis water filtration system to the refrigerator's cold water line must be at least 40 psi (276 kPa). If the water pressure is below these specifications:

- Check if the sediment filter in the reverse osmosis system is blocked. Replace the filter if necessary.
- Refill the water tank in the reverse osmosis system with water.
- If your refrigerator has a water filter, it may further reduce the water pressure when used in conjunction with a reverse osmosis system. Remove the water filter.

For more information or servicing, contact a licensed plumbing professional.

Ordering a new filter

To purchase a new water filter, contact a local Samsung service center or visit www.samsungparts.com on the web.

LED Lamps

To replace the lamps of the refrigerator, contact a local Samsung service center.

WARNING

- The lamps are not user-serviceable. Do not attempt to replace a lamp yourself. This can cause electric shock.

Troubleshooting

Before calling for service, review the symptoms and recommended solutions below. If none of the suggested solutions resolve your problem, please visit our website at www.samsung.com or call Samsung Customer Care at 1-800-SAMSUNG (726-7864). Note that you will be charged for any service visits in which no defects were found.

General

Temperature

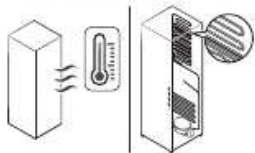
Symptom	Possible causes	Solution
Fridge/freezer does not operate. Fridge/freezer temperature is warm.	<ul style="list-style-type: none"> Power cord is not plugged in properly. 	<ul style="list-style-type: none"> Properly plug in the power cord.
	<ul style="list-style-type: none"> Temperature control is not set correctly. 	<ul style="list-style-type: none"> Set the temperature lower.
	<ul style="list-style-type: none"> Refrigerator is located near a heat source or direct sunlight. 	<ul style="list-style-type: none"> Keep the refrigerator away from direct sunlight or a heat source.
	<ul style="list-style-type: none"> Not enough clearance between refrigerator and nearby walls or cabinets. 	<ul style="list-style-type: none"> Make sure there is a gap of at least 2.5 inches (5 cm) between the refrigerator back and sides and any nearby walls or cabinets.
	<ul style="list-style-type: none"> The refrigerator is overloaded. Food is blocking the refrigerator vents. 	<ul style="list-style-type: none"> Do not overload the refrigerator. Do not allow food to block vents.
Fridge/freezer is over-cooling.	<ul style="list-style-type: none"> Temperature control is not set correctly. 	<ul style="list-style-type: none"> Set the temperature higher.
Interior wall is hot.	<ul style="list-style-type: none"> Refrigerator has heat-proof piping in the interior wall. 	<ul style="list-style-type: none"> To prevent condensation from forming, the refrigerator has heat-proof piping in the front corners. If the ambient temperature rises, this equipment may not work effectively. This is not a system failure. 

Troubleshooting

Troubleshooting

Odors

Symptom	Possible causes	Solution
Refrigerator has odors.	• Spoiled food.	• Clean the refrigerator and remove any spoiled food.
	• Food with strong odors.	• Make sure strong smelling food is wrapped airtight.

Frost

Symptom	Possible causes	Solution
Frost around the vents.	• Food is blocking the vents.	• Make sure no food blocks the refrigerator vents.
Frost on interior walls.	• Door is not closed properly.	• Make sure food does not block the door. Clean the door gasket.

Condensation

Symptom	Possible causes	Solution
Condensation forms on the interior walls.	• If door is left open, moisture enters the refrigerator.	• Remove the moisture and do not leave a door open for extended periods of time.
	• Food with high moisture content.	• Make sure food is wrapped airtight.

Water/ice (dispenser models only)

Symptom	Possible causes	Solution
Water flow is weaker than normal.	• Water pressure is too low.	• Make sure the water pressure is between 30 to 120 psi (206 to 827 kPa).
Ice maker makes a buzzing sound.	• The Ice Maker function is activated, but the water supply to the refrigerator has not been connected.	• Press Ice Maker .

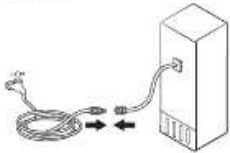
Symptom	Possible causes	Solution
Ice maker does not make ice.	• Ice maker has just been installed.	• You must wait for 12 hours for the refrigerator to make ice.
	• Freezer temperature is too high.	• Set the freezer temperature below 0 °F (-18 °C) or -4 °F (-20 °C) in warm ambient air.
	• Dispenser panel Lock is activated.	• Deactivate dispenser panel Lock.
	• Ice maker is off.	• Turn on the ice maker.
Ice does not dispense.	• Ice may jam if the ice dispenser is not used for a long time (approx. 3 weeks).	• If you won't be using the refrigerator for a long time, empty the ice bucket and turn off the ice maker.
	• Ice bucket is not properly inserted.	• Make sure the ice bucket is properly inserted.
	• Water line is not connected properly or water supply is not on.	• Check if the water line is installed correctly. Check if the water line stop cock is closed. 

Troubleshooting

Troubleshooting

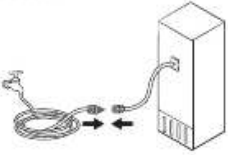
Symptom	Possible causes	Solution
Water does not dispense.	<ul style="list-style-type: none"> Water line is not connected properly or water supply is not on. 	<ul style="list-style-type: none"> Check if the water line is installed correctly. Check if the water line stop cock is closed. 
	<ul style="list-style-type: none"> Dispenser panel Lock is activated. 	<ul style="list-style-type: none"> Deactivate dispenser panel Lock.
	<ul style="list-style-type: none"> A third-party water filter was installed. 	<ul style="list-style-type: none"> Use only Samsung-provided or approved filters. Unapproved filters may leak and damage the refrigerator.
	<ul style="list-style-type: none"> Water filter indicator turns on or blinks. 	<ul style="list-style-type: none"> Replace the water filter. After replacing, reset the filter indicator sensor.

Do you hear abnormal sounds from the refrigerator?

Before calling for service, review the information below. If you still have questions about sounds your refrigerator is making, please call Samsung Customer Care at 1-800-SAMSUNG (726-7864). Note that you will be charged for any service visits related to normal operating sounds in which no defects were found.

These sounds are normal.

- When starting or ending an operation, the refrigerator may make sounds similar to a car engine ignition. As the operation stabilizes, the sounds will decrease.

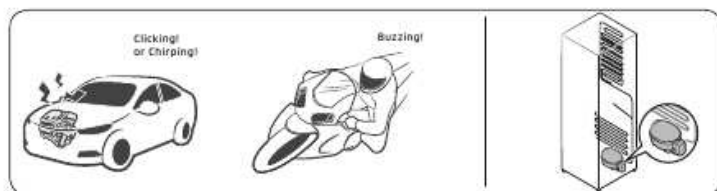

- While the fan is operating, these sounds may occur. When the refrigerator reaches the set temperature, the fan sound will stop.



Troubleshooting

Troubleshooting

- During a defrost cycle, water may drip on the defrost heater, causing sizzling sounds.

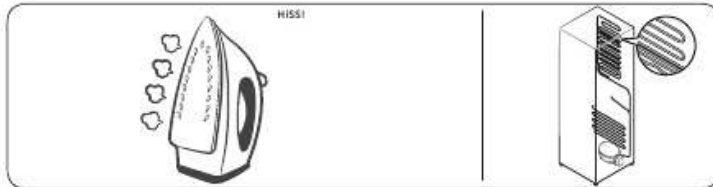

- As the refrigerator cools or freezes, refrigerant gas moves through sealed pipes, causing bubbling sounds.

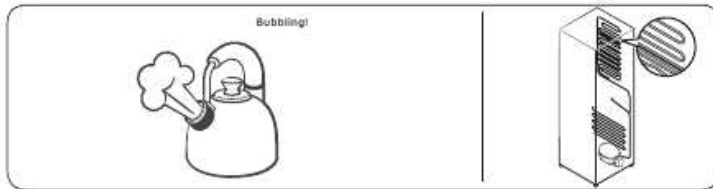

- As the refrigerator temperature increases or decreases, plastic parts contract and expand, creating knocking noises. These noises occur during the defrosting cycle or when electronic parts are working.

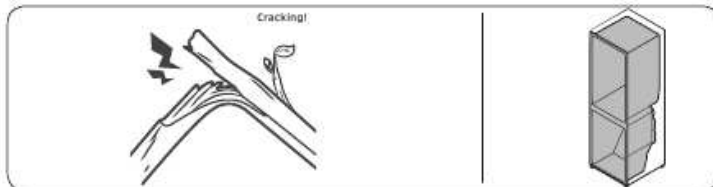

- For ice maker models: When the water valve opens to fill the ice maker, you may hear a buzzing sound.
- Due to pressure equalizing when you open and close the refrigerator door, you may hear a whooshing sound.

LIMITED WARRANTY (U.S.A.)

SAMSUNG REFRIGERATOR

LIMITED WARRANTY TO ORIGINAL CONSUMER PURCHASER WITH PROOF OF PURCHASE

This SAMSUNG brand product, as supplied and distributed by Samsung Electronics America, Inc. (SAMSUNG) and delivered new, in the original carton to the original consumer purchaser, is warranted by SAMSUNG against manufacturing defects in materials or workmanship for the limited warranty period of:

One (1) year parts and labor

Five (5) years parts and labor on Sealed Refrigeration System Only (Compressor, Evaporator, Condenser, Drier, and Connecting Tubing)

Ten (10) years part and Five (5) years labor on Digital Inverter Compressor Only

This limited warranty is valid only on products purchased and used in the United States that have been installed, operated, and maintained according to the instructions attached to or furnished with the product. To receive warranty service, the purchaser must contact SAMSUNG at the address or phone number provided below for problem determination and service procedures. Warranty service can only be performed by a SAMSUNG authorized service center. The original dated bill of sale must be presented upon request as proof of purchase to SAMSUNG or SAMSUNG's authorized service center to receive warranty service.

SAMSUNG will provide in-home service within the contiguous United States during the warranty period at no charge, subject to availability of SAMSUNG authorized servicers within the customer's geographic area. If in-home service is not available, SAMSUNG may elect, at its option, to provide transportation of the product to and from an authorized service center. If the product is located in an area where service by a SAMSUNG authorized servicer is not available, you may be responsible for a trip charge or required to bring the product to a SAMSUNG authorized service center for service.

To receive in-home service, product must be unobstructed and accessible to the service agent.

During the applicable warranty period, a product will be repaired, replaced, or the purchase price refunded, at the sole option of SAMSUNG. SAMSUNG may use new or reconditioned parts in repairing a product, or replace the product with a new or reconditioned product. Replacement parts and products are warranted for the remaining portion of the original product's warranty or ninety (90) days, whichever is longer. All replaced parts and products are the property of SAMSUNG and you must return them to SAMSUNG.

LIMITED WARRANTY (U.S.A.)

This limited warranty covers manufacturing defects in materials or workmanship encountered in normal household, noncommercial use of this product and shall not cover the following: damage that occurs in shipment, delivery, installation, and uses for which this product was not intended; damage caused by unauthorized modification or alteration of the product; product where the original factory serial numbers have been removed, defaced, changed in any way, or cannot be readily determined; cosmetic damage including scratches, dents, chips, and other damage to the product's finishes; damage caused by abuse, misuse, pest infestations, accident, fire, floods, or other acts of nature or God; damage caused by use of equipment, utilities, services, parts, supplies, accessories, applications, installations, repairs, external wiring or connectors not supplied or authorized by SAMSUNG; damage caused by incorrect electrical line current, voltage, fluctuations and surges; damage caused by failure to operate and maintain the product according to instructions; in-home instruction on how to use your product; and service to correct installation not in accordance with electrical or plumbing codes or correction of household electrical or plumbing (i.e., house wiring, fuses, or water inlet hoses). The cost of repair or replacement under these excluded circumstances shall be the customer's responsibility.

Visits by an authorized servicer to explain product functions, maintenance or installation are not covered by this limited warranty. Please contact SAMSUNG at the number below for assistance with any of these issues.

EXCLUSION OF IMPLIED WARRANTIES

IMPLIED WARRANTIES, INCLUDING THE IMPLIED WARRANTIES OF MERCHANTABILITY OR FITNESS FOR A PARTICULAR PURPOSE, ARE LIMITED TO ONE YEAR OR THE SHORTEST PERIOD ALLOWED BY LAW. Some states do not allow limitations on how long an implied warranty lasts, so the above limitations or exclusions may not apply to you. This warranty gives you specific rights, and you may also have other rights, which vary from state to state.

LIMITATION OF REMEDIES

YOUR SOLE AND EXCLUSIVE REMEDY IS PRODUCT REPAIR, PRODUCT REPLACEMENT, OR REFUND OF THE PURCHASE PRICE AT SAMSUNG'S OPTION, AS PROVIDED IN THIS LIMITED WARRANTY. SAMSUNG SHALL NOT BE LIABLE FOR SPECIAL, INCIDENTAL OR CONSEQUENTIAL DAMAGES, INCLUDING BUT NOT LIMITED TO TIME AWAY FROM WORK, HOTELS AND/OR RESTAURANT MEALS, REMODELING EXPENSES, LOSS OF REVENUE OR PROFITS, FAILURE TO REALIZE SAVINGS OR OTHER BENEFITS REGARDLESS OF THE LEGAL THEORY ON WHICH THE CLAIM IS BASED, AND EVEN IF SAMSUNG HAS BEEN ADVISED OF THE POSSIBILITY OF SUCH DAMAGES. Some states do not allow exclusion or limitation of incidental or consequential damages, so the above limitations or exclusions may not apply to you. This warranty gives you specific rights, and you may also have other rights, which vary from state to state.

SAMSUNG does not warrant uninterrupted or error-free operation of the product. No warranty or guarantee given by any other person, firm, or corporation with respect to this product shall be binding on SAMSUNG.

To obtain warranty service, please contact SAMSUNG at:

Samsung Electronics America, Inc.
85 Challenger Road
Ridgefield Park, NJ 07660
1-800-SAMSUNG (726-7864)
www.samsung.com/us/support

Warranty Information (CANADA)

If your refrigerator needs service

Do not hesitate to call any Samsung Authorized Service Center nearby giving them your name, address and telephone number if your product is not functioning properly.

Limited Warranty for Original Purchaser

This Samsung product is warranted by Samsung Electronics Canada Inc. (hereafter referred to as SECA) against manufacturing defects in material or workmanship for the following periods:

Labor : 1 year (in-home)

Parts : 1 year

Inverter Compressor : 10 years (Part only)

SECA further warrants that if this product fails to operate properly within the specified warranty period and the failure is due to improper workmanship or defective material, SECA will repair or replace the product at its option. In-home service is not available in all areas. Contact us to find out if in-home service is currently available in your area by using the contact information at the back of this warranty.

All warranty repairs or part replacements must be performed by a SECA Authorized Service Center. (To find the nearest SECA Service Center, call 1-800-SAMSUNG (7267864) or visit our web site at www.samsung.com/ca)

Obligation to the Original Owner

The original dated sales receipt must be retained by the customer and is the only acceptable proof of purchase. It must be presented to a SECA Authorized Service Center at the time service is requested before warranty services are rendered. On all carry-in models, transportation to and from the Authorized Service Center is the responsibility of the customer.

Exclusions of the Warranty

This warranty does not cover damage due to accident, fire, flood, and/or other Acts of God, misuse, incorrect line voltage, improper installation, improper or unauthorized repairs, commercial use, or damage that occurs during shipping. Customer adjustments which are explained in this owners manual are not covered under the terms of this warranty. This warranty will automatically be voided for any unit found with a missing or altered serial number. This warranty is valid only on products purchased and used in Canada.

SAMSUNG CUSTOMER CARE CENTER

Samsung Electronics Canada Inc.
2050 Derry Road West
Mississauga, Ontario L5N 0B9
Canada
1-800-SAMSUNG (726-7864)
www.samsung.com/ca/support (English)
www.samsung.com/ca_fr/support (French)

SAMSUNG



Scan the QR code* or visit
www.samsung.com/spsn
to view our helpful
How-to Videos and Live Shows

* Requires reader to be installed on your
smartphone

Scan this with your smartphone

Contact SAMSUNG WORLD WIDE

If you have any questions or comments relating to Samsung products, please contact the SAMSUNG Customer Care Center.

Country	Contact Center	Web Site
U.S.A	1-800-SAMSUNG (726-7864) 1-844-SAM-PAYS (726-7297)	www.samsung.com/us/support
CANADA	1-800-SAMSUNG(726-7864) 1-844-SAM-PAYS (726-7297)	www.samsung.com/ca/support (English) www.samsung.com/ca_fr/support (French)



DA68-04012L-00