



PROJECT SOURCE.

Project Source® is a registered trademark of LF, LLC. All rights reserved.

ITEM #0344612
0344605
0344596

5-LIGHT CHANDELIER

MODEL #FD10-055
FD10-055-1
FD10-055-2

Français p. 8

Español p. 15

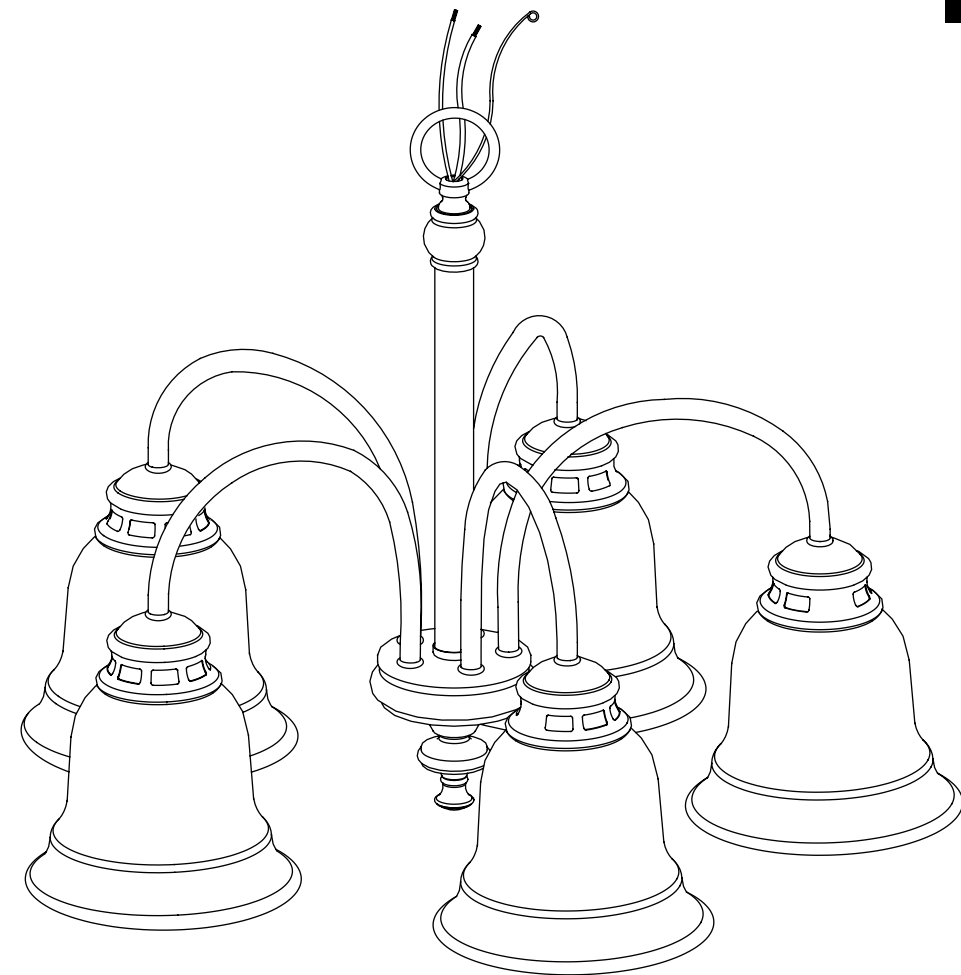

ATTACH YOUR RECEIPT HERE

Serial Number _____ Purchase Date _____



Intertek



Questions, problems, missing parts? Before returning to your retailer, call our customer service department at 1-866-389-8827, 8 a.m. - 6 p.m., EST, Monday - Thursday, 8 a.m. - 5 p.m., EST, Friday.

PACKAGE CONTENTS

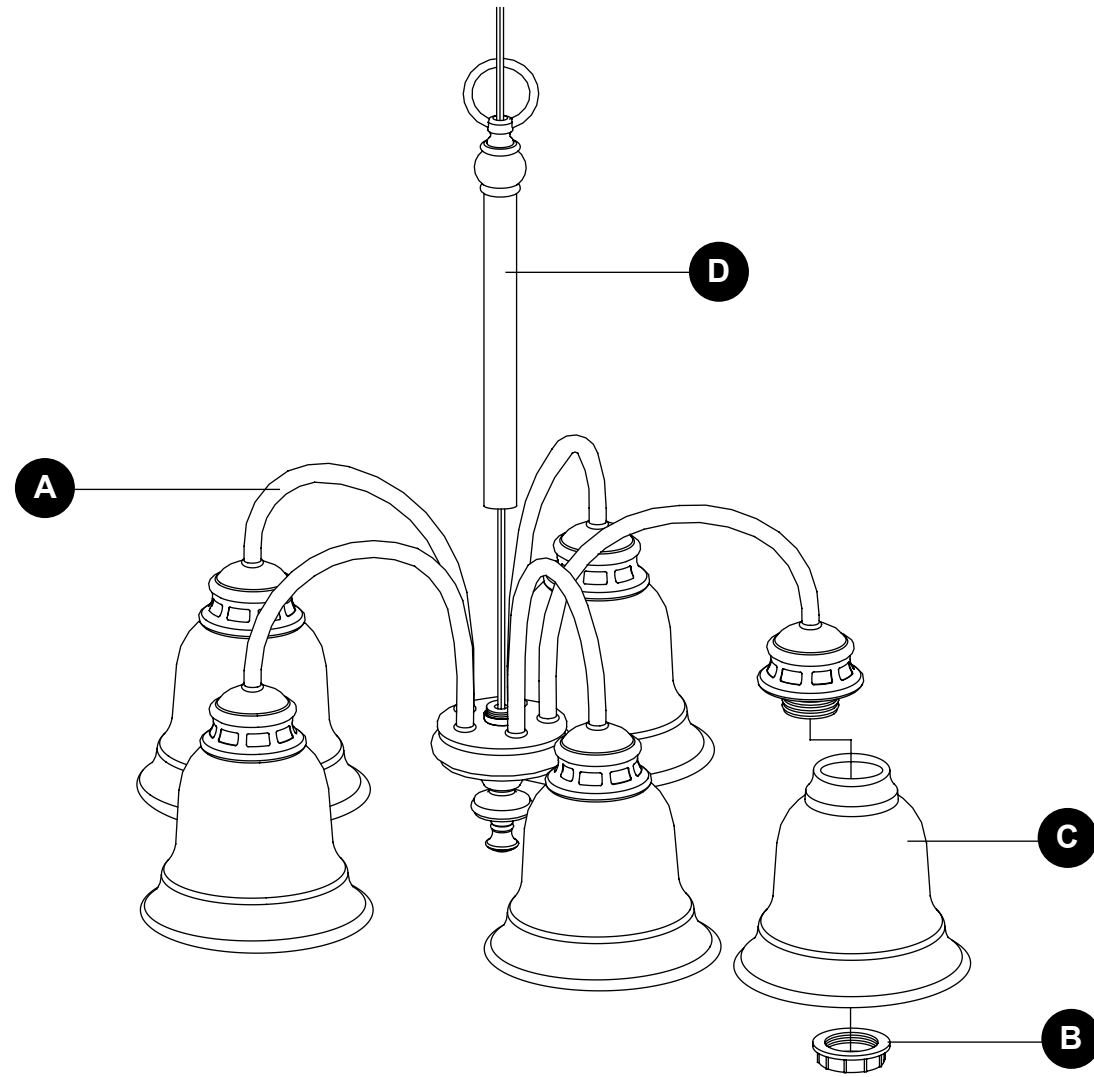

PART	DESCRIPTION	QUANTITY
A	Fixture	1
B	Check ring (preassembled to Fixture (A))	5
C	Glass shade	5
D	Pole	1

HARDWARE CONTENTS (shown actual size)

AA	BB	CC	DD	EE	FF	GG	HH	II	JJ
Hex nut	Wire nut	Mounting screw	Chain (Not actual size)	Ring (Not actual size)	Screw collar loop (Not actual size)	Washer	Threaded nipple	Mounting bar (Not actual size)	Canopy (Not actual size)
Qty. 1	Qty. 3	Qty. 2	Qty. 1	Qty. 1	Qty. 1	Qty. 1	Qty. 1	Qty. 1	Qty. 1

SAFETY INFORMATION

Please read and understand this entire manual before attempting to assemble, operate or install the product.

WARNING

- **TURN OFF ELECTRICITY** at main fuse box (or circuit breaker box) before beginning installation by removing fuse (or switching off circuit breaker).
- **MINIMUM 90°C SUPPLY CONDUCTORS.**

CAUTION

- **CONSULT A QUALIFIED ELECTRICIAN TO ENSURE CORRECT BRANCH CIRCUIT CONDUCTOR.**
- If in doubt about electrical installation, consult a licensed electrician.

PREPARATION

Before beginning assembly of product, make sure all parts are present. Compare parts with package contents list and hardware contents above. If any part is missing or damaged, do not attempt to assemble the product. Contact customer service for replacement parts.

Estimated Assembly Time: 35 minutes





Tools Required for Assembly (not included): Flathead screwdriver, Phillips screwdriver, Pliers, Electrical tape, Wire cutters, Safety glasses.

Helpful Tools (not included): Wire strippers.

ASSEMBLY INSTRUCTIONS





1. Attach the mounting bar (II) by tightening the mounting screws (CC) securely into the outlet box (not included). The threaded nipple (HH) should protrude away from the outlet box. Turn the hex nut (AA) clockwise to tighten the threaded nipple (HH) and washer (GG) onto the mounting bar (II).

Hardware Used

AA Hex nut		x 1
CC Mounting screw		x 2
GG Washer		x 1
HH Threaded nipple		x 1
II Mounting bar		x 1

2. Strip 3/4 in. of insulation from wire ends. Pass the wire through the chain (DD), ring (EE), screw collar loop (FF), canopy (JJ) and threaded nipple (HH). Twist stripped ends together with pliers, black to the wire with smooth surface (power) and white to the wire with longitudinal ridges (neutral). Attach copper wire to ground wire. Helpful hint: If necessary, attach copper ground wire to grounded junction box.

Hardware Used

DD Chain		x 1
EE Ring		x 1
FF Screw collar loop		x 1
HH Threaded nipple		x 1
JJ Canopy		x 1

3. Attach wire nuts (BB). Tape wire nuts (BB) and wires together.

Hardware Used

BB Wire nut		x 3
--------------------	---	-----

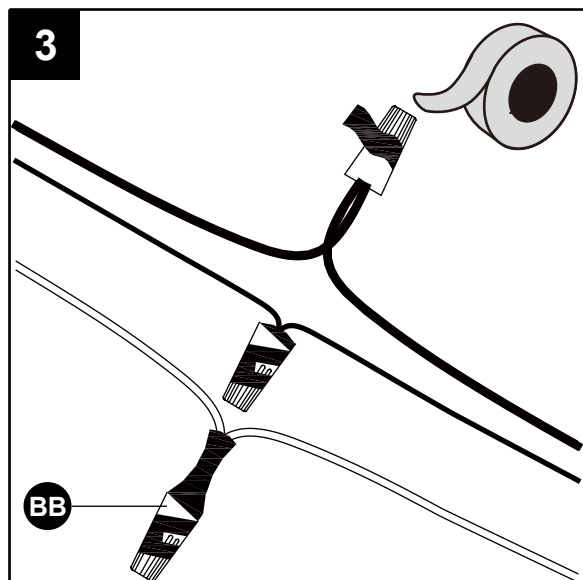
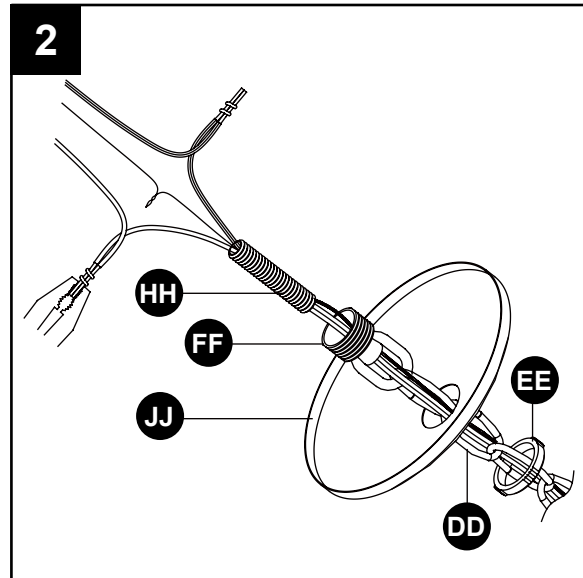
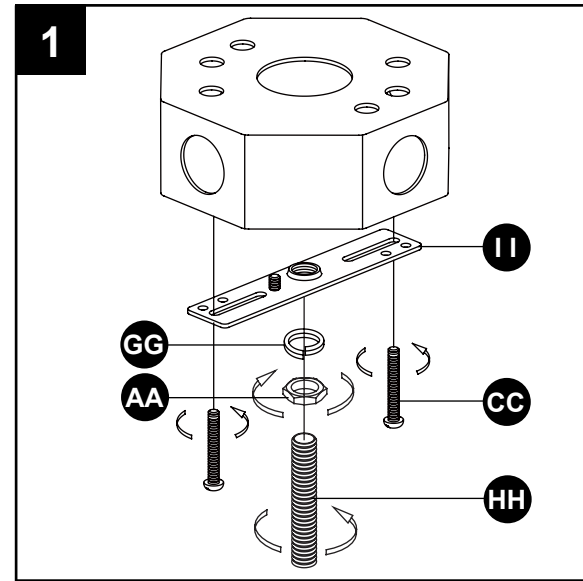



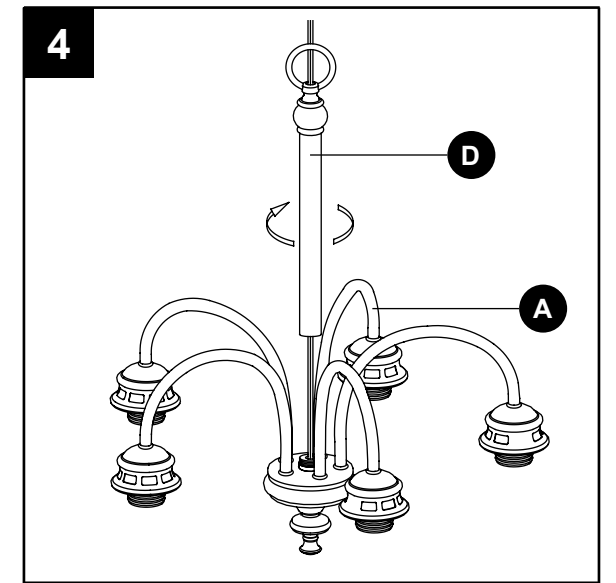

ASSEMBLY INSTRUCTIONS

4. Install the pole (D) onto the fixture (A).



5. Install screw collar loop (FF) into threaded nipple (HH). Place the canopy (JJ) into screw collar loop (FF) and secure with ring (EE). Open the top section of the chain (DD), then attach it to the screw collar loop (FF). Open the bottom section of the chain (DD), then attach it to the flying ring (A).

Hardware Used

DD Chain		x 1
EE Ring		x 1
FF Screw collar loop		x 1
HH Threaded nipple		x 1
JJ Canopy		x 1

6. Take off check ring (B), install the glass shade (C) over the socket, and then secure with check ring (B).

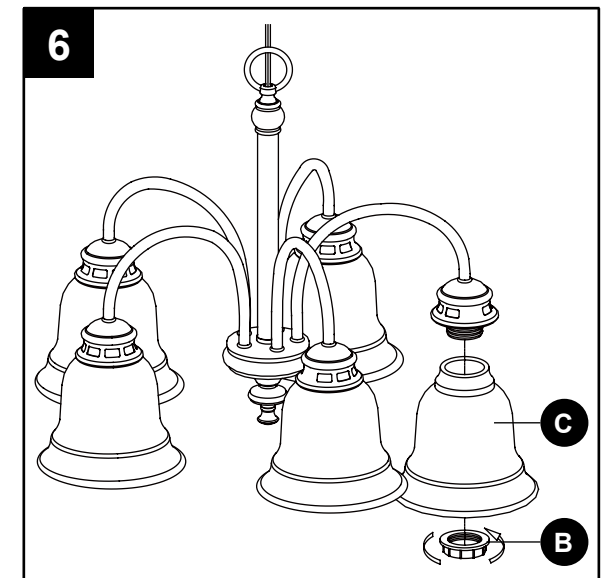
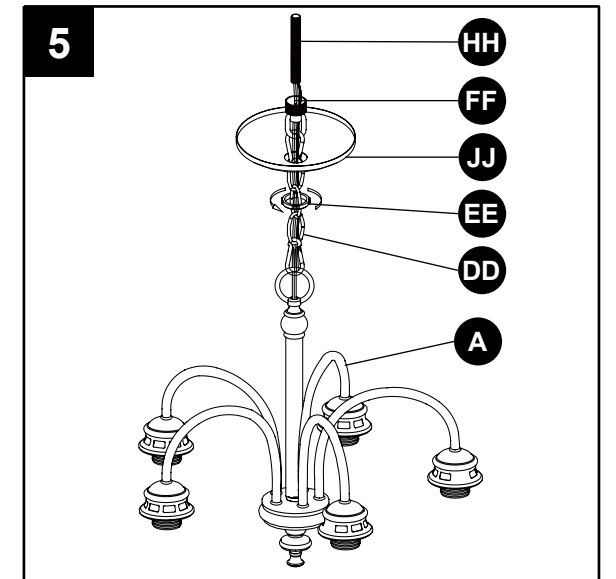

ASSEMBLY INSTRUCTIONS

7. Install light bulbs (not included). Use only 60-watt or less standard-base bulbs.

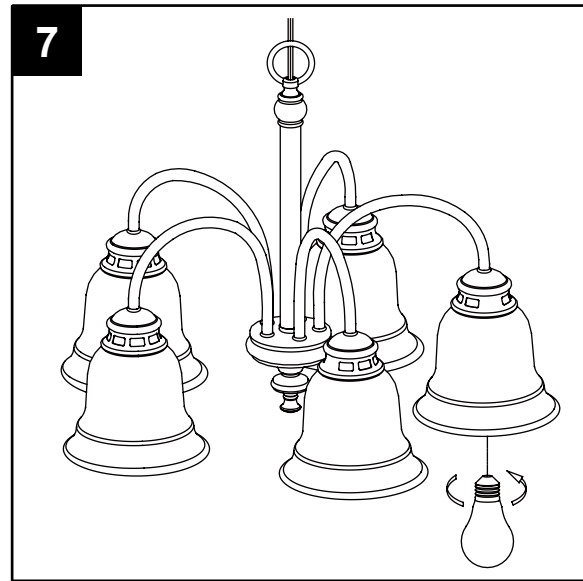

CARE AND MAINTENANCE

- Shut off main power supply before wiping product with damp cloth or window cleaner. Do not use abrasives.

TROUBLESHOOTING

PROBLEM	POSSIBLE CAUSE	CORRECTIVE ACTION
Bulb won't light.	<ol style="list-style-type: none"> 1. Bulb is burned out. 2. Power is off. 3. Faulty wire connection. 4. Faulty switch. 	<ol style="list-style-type: none"> 1. Replace light bulb. 2. Make sure power supply is on. 3. Check wiring. 4. Test or replace switch.
Fuse blows or circuit breaker trips when light is turned on.	Crossed wires or power wire is grounding out.	Check wire connections.

WARRANTY

The manufacturer warrants all of its lighting fixtures against defects in materials and workmanship for one (1) year from the date of purchase. If within this period the product is found to be defective in material or workmanship, the product must be returned, with a copy of the original sales receipt as proof of purchase in the original carton, to the place of purchase. The manufacturer will, at its option, repair, replace or refund the original purchase price to the consumer. This warranty does not cover fixtures becoming defective due to misuse, accidental damage, improper handling and/or installation and specifically excludes liability for direct, incidental or consequential damages. As some states do not allow exclusions or limitations on an implied warranty, the above exclusions and limitations may not apply to you. This warranty gives you specific legal rights, and you may have other rights that vary from state to state.

REPLACEMENT PARTS LIST

For replacement parts, call our customer service department at 1-866-389-8827, 8 a.m. - 6 p.m., EST, Monday - Thursday, 8 a.m. - 5 p.m., EST, Friday.

PART	DESCRIPTION	PART #
AA	Hex nut	100-100300
BB	Wire nut	375-022000
CC	Mounting screw	109-042600
EE	Ring	113-030000
FF	Screw collar loop	113-046004
GG	Washer	107-141000
HH	Threaded nipple	103-100500
II	Mounting bar	139-103009

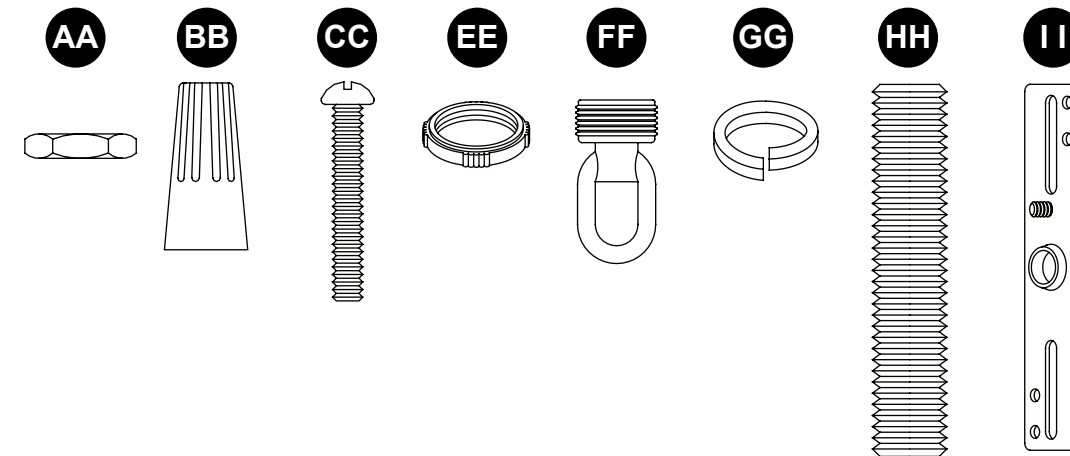

Printed in China

Project Source® is a registered trademark of LF, LLC. All rights reserved.