



GARDEN & PATIO PROPANE HEATER Owner's Manual

Item #: 60368



***** IMPORTANT NOTICE *****

- Do NOT return to place of purchase!!!

Please contact our Toll Free Hotline:

(866) 985-7877

for customer service & warranty issues

E-mail: cservice@welltraveled.net

Hotline hours: Mon.-Fri. 9:00am-6:00pm(E.S.T.)

- Establishing a burner ignition for the **FIRST** time or after changing the cylinder tank may take up to 2-3 minutes in order for the gas to purge through the feeder lines.



Warning: For OUTDOOR USE only

USING THIS ITEM IN IMPROPERLY VENTILATED AREAS CAN LEAD TO SERIOUS INJURY OR DEATH. USE ONLY IN OUTDOOR AREAS.

TABLE OF CONTENTS

*** WARNING ***

Improper operation, installation, adjustment, alteration, servicing or maintenance can cause severe property damage and/or serious injury or death. Please read the installation, operating and maintenance instructions thoroughly before installing, operating or servicing this appliance.

*** For Your Safety ***

If you smell gas:

- 1- Shut off gas to appliance
- 2- Extinguish any open flame
- 3- If odor continues, immediately call your gas supplier

*** For Your Safety ***

Do NOT store or use gasoline or other flammable vapors in the vicinity of this or any other appliance.



- Establishing a burner ignition for the FIRST time or after changing the cylinder tank may take up to 2-3 minutes in order for the gas to purge through the feeder lines.

- If stored indoors, detach and leave cylinder outdoors.

- Keep this manual in your files for future reference.

NOTE: 20 lb., 5 Gallon LPG Tank is not included.

TABLE OF CONTENTS

GENERAL DESCRIPTION.....	3-4
PRECAUTIONS.....	5
TOOLS & PARTS REQUIRED.....	6
ASSEMBLY INSTRUCTIONS.....	7-9
GAS REQUIREMENTS & LEAK TESTS.....	9-10
HEATER LOCATION.....	10-11
OPERATION & STORAGE.....	11-12
TROUBLESHOOTING.....	13
STORAGE & MAINTENANCE.....	14
WARRANTY & SERVICE.....	15



*** IMPORTANT NOTICE ***

- Do NOT return to place of purchase!!!
Please contact our Toll Free Hotline:

(866) 985-7877

E-mail: cservice@welltraveled.net

GENERAL DESCRIPTION

A patio/deck & garden heater for operation with LPG (Liquid Propane Gas). For connection/working pressure information & lighting instructions, see the appliance data plate labels and this manual.

*** IMPORTANT NOTICE ***

- Do NOT return to place of purchase!!!
Please contact our Toll Free Hotline:

(866) 985-7877

E-mail: cservice@welltraveled.net

MAIN COMPONENTS

1. Cylinder base, 18" dia.
2. Tank housing
3. Main Post 2pcs components
4. Post support bracket assembly
5. Base of control housing
6. Intake screen
7. Burner base
8. Emitter Flame screen
9. Reflector Hood, 32" Dia.
10. Gas valve controller
11. Ignitor button
12. Gas inlet supply hose
13. Gas Regulator
14. Wheel Assembly



*** IMPORTANT NOTICE ***

Establishing a burner ignition for the FIRST time or after changing the cylinder tank may take up to 2-3 minutes in order for the gas to purge through the feeder lines.

*** NOTICE ***

During the FIRST TIME use only. It is normal to experience a small amount of smoke coming from the reflector hood. This is due to the burn off of the protective coating applied during the manufacturing process.

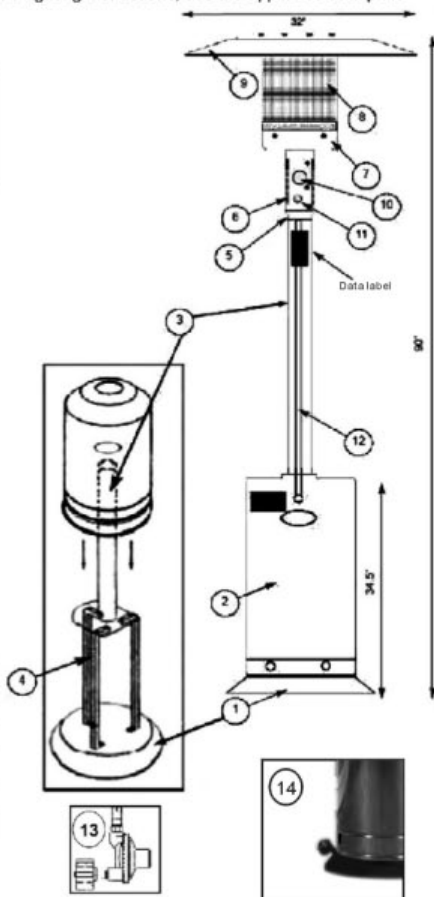

***** IMPORTANT NOTICE *****

- Do NOT return to place of purchase!!!

Please contact our Toll Free Hotline:

(866) 985-7877

E-mail: cservice@welltraveled.net



1.1 Construction Characteristics

- Color: Brushed matte finish on stainless steel models. (Powder coat finish steel models.)
Casings: Base material Deluxe Models feature stainless steel. (Galvanized sheet metal on steel models.)

The burner is controlled using a positive lock, on/off gas control valve. The gas supply is controlled from gas cylinder valve. The burner & burner assembly components are constructed from stainless steel. Emission of infrared heat is assisted by the aluminum reflector hood.

SAFETY Feature: This appliance has a built in "gas cut off" switch that shuts off the gas supply to the heater assembly head anytime the Burner Unit is tilted beyond 18 degrees or burner flame is extinguished.

1.2 Technical Data

- | | | |
|-------------------------------|---|--|
| * Operating pressure with gas | : | 11"WC (water column) (2.75 Kpa) |
| * Inlet gas supply pressure | : | Min. - 5 psi, Max. - 150 psi |
| * Max. Heat rating | : | BTU 46,000 |
| * Low setting rating | : | BTU 17,500 |
| * Radiant Heat Range | : | 14 ft. to 16 ft. diameter |
| * Fuel Type | : | Liquid Propane Gas |
| * Cylinder Size | : | Standard Industry 20lb. Cylinder
(5 gal. cylinder capacity) |
| * Consumption Rate | : | Approx. 10 hrs. at highest setting |
| * Gross Weight | : | 53 lbs. |
| * Certifications | : | CSA |

Gas Pressure	Main Orifice
Water Column	Diameter in mm
11" (2.75 Kpa)	1.8



- * Made in China

***** WARNING *****



Improper operation, installation, adjustment, alteration, servicing or maintenance can cause severe property damage and/or serious injury or death. Please read the installation, operating and maintenance instructions thoroughly before installing, operating or servicing this appliance.

***** IMPORTANT NOTICE *****

- Do NOT return to place of purchase!!!

Please contact our Toll Free Hotline:

(866) 985-7877

E-mail: cservice@welltraveled.net



PRECAUTIONS - SAFETY FIRST!

PLEASE READ THE FOLLOWING SAFETY RULES

- * **Do not** use this space heater in an explosive atmosphere. Keep heater away from areas where gasoline or other flammable liquids or vapors are stored.
- * Prior to use, check for damaged parts such as hoses, regulators, pilot, or burner.
- * **Do not** attempt to alter unit in any manner. (EXAMPLE: Using the heater without the top canopy reflector or radiant screen.) **Do not** shorten the burner post assembly.
- * Heater must always be placed on a stable, solid level surface.
- * Always maintain proper clearance to combustible materials. (Top: 36", sides: 24")
- * Always ensure there is ample fresh air ventilation. **For outdoor use ONLY.**
- * Never replace or substitute the regulator with any regulator other than an original factory supplied replacement or UL listed regulator.
- * **Do not** clean heater with cleaners that are combustible or corrosive.
- * **Do not** paint radiant screen, control panel, or top canopy reflector.
- * All leak tests should be done with a soapy solution. **NEVER USE AN OPEN FLAME TO CHECK FOR LEAKS.**
- * The LP tank should be completely turned off at the cylinder valve when the heater is not in use.



***** WARNING *****

Improper operation, installation, adjustment, alteration, servicing or maintenance can cause severe property damage and/or serious injury or death. Please read the installation, operating and maintenance instructions thoroughly before installing, operating or servicing this appliance.

***** THINK SAFETY!*****

After appliance shut down,
do NOT touch or move unit for at least 30 minutes. This allows for proper cooling of heater components.

* At least once a year, the unit should be inspected for the presence of spiders, spider webs, or other insects. The burner area is a common spider haven and can damage the heater and render it unsafe for use.

Check the heater immediately if any of the following exists:

1. The smell of gas in conjunction with extreme yellow tipping of the burner flames.
2. The heater does not reach maximum temperature.
3. The burner makes a popping noise during use (a slight popping noise is normal when the burner is extinguished.)

- * The LP regulator/hose assembly shall be kept completely inside cylinder housing.
- * Children and adults should be aware of the hazards of high surface temperatures and should use extreme caution and keep proper distance away from main heater unit to avoid burns or clothing ignition.
- * **Young children** should be carefully supervised when they are in the area of the heater.
- * **Clothing or other flammable materials** should not be hung from the heater, or placed on or near the heater.
- * Any guard or other protective device removed for servicing the heater must be replaced prior to operating the heater.
- * Installation and repair should be done by a qualified service person. The heater should be inspected before use and at least annually by a qualified service person. More frequent cleaning may be required. It is imperative that control compartment, burner and air circulation passageways of the heater be kept clean & clear of debris, insects, spider webs, etc.
- * **Keep** the appliance area clear and free of combustion materials, gasoline and other flammable vapors and liquids.
- * **Do not** obstruct the flow of combustion and ventilation air.
- * **Keep** the ventilation opening of the cylinder housing enclosure free and clear of debris.
- * **Save these instructions! Retain in a safe place for future reference.**

***** IMPORTANT NOTICE *****

- Do NOT return to place of purchase!!!

Please contact our Toll Free Hotline:

(866) 985-7877

E-mail: cservice@welltraveled.net



TOOLS AND PARTS NEEDED FOR ASSEMBLY

NOTE: 20 Pound, 5 Gallon Capacity - Standard LPG Tank/Cylinder is NOT supplied.

Tools Needed:

- Adjustable Wrench
- Phillips Head Screwdriver (#2 or #3 blade)
- Spray Bottle of Soapy Water or Paint Brush and Soapy Water (to check for leaks)

Parts Supplied:

- * Main Burner/Head assembly unit w/ flexible gas hose
- * 1 pc. 18" Cylinder Base
- * LPG Tank housing unit
- * 34" Support Post (2pcs components see fig B-2)
- * Post Support Brackets (3 each)
- * LPG Gas Regulator with Hose
- * 32" Aluminum Reflector Hood (5 pc. components, see fig. D)

Fig.A * 4 ea. - M6 x 10mm bolts for Burner Assembly & Upper Post

Fig.B * **B-1 6 ea. - M6 x 35mm long bolts with M6 nuts and washers for Post Brackets**

Fig.C * 3 ea. - M8 x 16mm short bolts for Post Bracket to Cylinder Base

Fig.D * 12 ea. - 1/4" cap nuts for attaching reflector hood components

Fig.E * 3 ea. - Large wing nut to attach reflector hood to burner head unit

Fig.F * 6 ea. - M6 x 25mm bolts to attach wheel assembly brackets

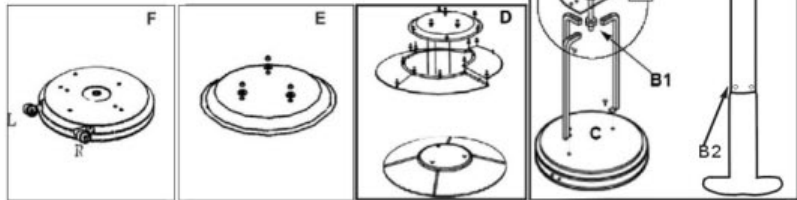
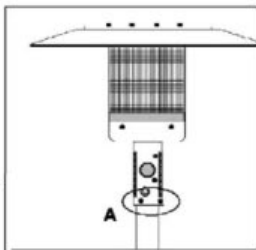

For questions, replacement parts, service help, or other assistance, please call the Customer Service Hotline!

***** IMPORTANT NOTICE *****

The installation must conform with local codes or, in the absence of local codes, with the most current version of the National Fuel Gas Code, ANSIZ223.1



ASSEMBLY INSTRUCTIONS

STEP 1:

- 1-1. Place the 3 post mounting brackets on the Cylinder Base as shown.
- 1-2. Use 3-M8 x 15mm bolts to secure brackets to the base.

STEP 1a:

- 1a-1. Attach wheel assembly brackets to cylinder base. Align holes and position as shown. Thread 3, M6 x 25mm bolts per bracket and tighten securely. (Do not overtighten.)

STEP 2:

- 2-1. Place the tall upright the base of support post onto the top of the post brackets, aligning pre-drilled holes as shown.
- 2-2. Use 6-M6 x 35mm bolts, washers & nuts to attach post to post brackets. Tighten securely.
- 2-3. Put the pole onto the base of support post and use 4-M6 x 10mm bolts to fix it.

STEP 3:

- Carefully, slide the tank cover over the post and onto the cylinder base. Tank cover should fit into pre-molded slots in base unit.

For questions, replacement parts, service help, or other assistance, please call the Customer Service Hotline!

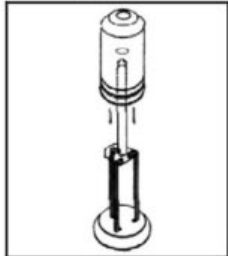
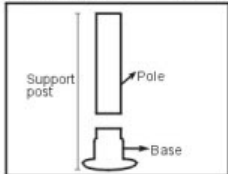
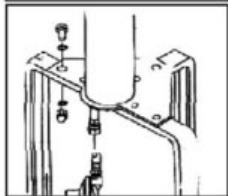
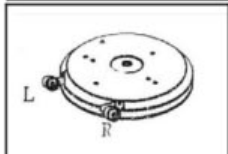
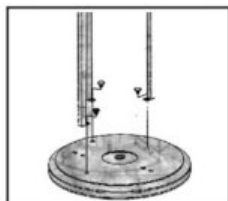

***** IMPORTANT NOTICE *****

- Do NOT return to place of purchase!!!

Please contact our Toll Free Hotline:

(866) 985-7877

E-mail: cservice@welltraveled.net



ASSEMBLY INSTRUCTIONS

STEP 4:

- 4-1. Carefully insert gas inlet hose completely through the post resting heater head unit on the support post.
- 4-2. Make sure both components are level and aligned with one another and are at a 90 degree angle to the floor. Align the holes of the support post with the holes at the bottom of the head unit. Attach using 4- M6 x 10mm bolts. Use a Phillips head screwdriver to tighten securely.

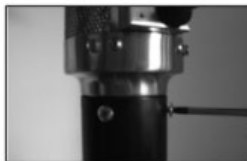

For questions, replacement parts, service help, or other assistance, please call the Customer Service Hotline!

STEP 5:

- 5-1. Place the 4 reflector components together, overlapping the edges as shown and fitting the pre-installed threaded studs through the pre-drilled holes. Attach using washers and cap nuts.
- 5-2. Position the round center component over the remaining exposed studs at the center and attach using washers and cap nuts. Tighten securely.

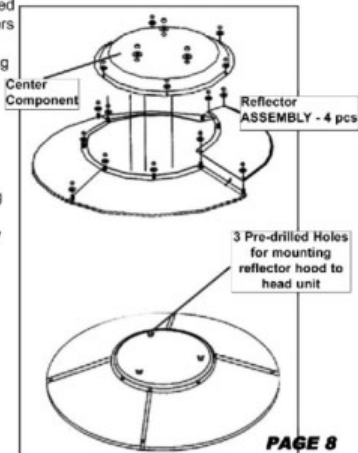

STEP 6:

- 6-2. Place the assembled reflector hood over the 3 securing threaded bolts located on the top of the head unit.
- 6-2. Fit a washer onto each reflector support bolt and tightly secure with wing nuts.

***** IMPORTANT NOTICE *****

- Do NOT return to place of purchase!!!

Please contact our Toll Free Hotline:

(866) 985-7877

E-mail: cservice@welltraveled.net



SAFETY FIRST!!!

- * Inspect the gas hose before each use of the appliance.
- * The hose/regulator assembly must be **REPLACED** prior to the appliance being put into operation if there is evidence of excessive abrasion or wear, or if the hose is damaged.
- * Any replacement assembly **must meet** original equipment manufacturer's specifications.

STEP 7:

- 7-1. Raise the tank housing cover and place on the post plate as illustrated.
- 7-2. Fit the gas regulator flexible hose to the threaded end of the gas inlet hose.
- 7-3. Tighten the fitting nut of the hose to the inlet gas hose. Be careful not to overtighten.
- 7-4. Place LP gas tank into cylinder base.
- 7-5. Connect the regulator with the LPG gas tank. Note: left hand thread direction - **Hand tighten** securely using quick connect turn knob. Do not overtighten.

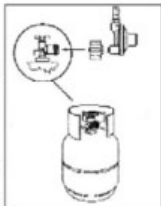

***** For Your Safety *****

If you smell gas:

- 1- Shut off gas to appliance
- 2- Extinguish any open flame
- 3- If odor continues, immediately call your gas supplier

GAS REQUIREMENTS & LEAK TESTING

NEVER CONNECT AN UNREGULATED GAS SUPPLY TO THE HEATER.

PRECAUTIONS

- * Periodically check the whole system for leaks or if the smell of gas is detected.
- * Extinguish all open flames. Perform ALL leak tests outdoors.
- * Never leak test while smoking.
- * If you can not stop a leak, turn off the gas supply and call the Customer Service Hotline, or your local gas company.
- * For best results, the heater must be checked with a full cylinder.
- * **Do not use the heater until all connections have been leak tested and are sound!!**
- * Only those parts recommended by the manufacturer should be used. Substitution can void the warranty.

GAS REQUIREMENTS

- * Maximum inlet pressure to propane regulator must not exceed 125 P.S.I.
- * A minimum supply pressure of 11.0 W.C. is required for the purpose of input adjustment for propane gas.
- * The pressure regulator and hose assembly supplied with the appliance **MUST** be used. Replacement pressure regulator and hose must conform to standards & specifications of the appliance manufacturer.
- * The installation must conform with local codes, or in the absence of local codes, with National Fuel Gas code, ANSI/NFPA 58 or ANSI Z233.1-1998. (Canada - CAN/CGA-B149.1 & 2-M86)

***** IMPORTANT NOTICE *****

- Do NOT return to place of purchase!!!

Please contact our Toll Free Hotline:

(866) 985-7877

E-mail: cservice@welltraveled.net



PROPANE CYLINDER TANK

- * The heater comes equipped with a hose assembly for hook-up to a standard propane gas tank. The propane tank is NOT included.
- * A dented, rusted or damaged propane tank may be hazardous and should be checked by your tank supplier. **Never use a propane tank with a damaged valve connection.**
- * The propane tank must be constructed and marked in accordance with the specifications for LP gas cylinders per the US Department of Transportation (DOT).
- * The propane tank must be designed to provide for vapor withdrawal from the operating cylinder.
- * Never connect an unregulated propane tank to the heater.

LEAK TESTING

- * Gas connections on the heater are gas tested at the factory prior to shipment. A complete gas tightness check must be performed at the installation site due to potential shipment irregularities or excessive pressure being applied to the heater as well as to check final installation of components by the consumer.

TO LEAK TEST

- * Make a soapy solution of one part liquid detergent and one part water. The soap solution can be applied with a spray bottle, brush, or rag. Soap bubbles will appear where a leak is present.
- * Make certain the safety control valve is in the "OFF" position (at the control panel of the head unit).
- * Turn the gas supply "ON" at the propane cylinder valve. Apply/spray several drops on the regulator hose to gas inlet hose connection, and the regulator to tank cylinder connection. (small bubbles indicate a leak)
- * If a leak is present, turn "OFF" the gas supply, loosen and then re-tighten and leaking fittings, turn gas supply "ON" again and recheck. Repeat as needed.

LOCATING HEATER FOR USE

BE CAREFUL: When certain material or items are left under this space heater while in use, they will be subjected to radiant heat and could be seriously damaged!

- * The heater is primarily for heating of outdoor patios, decks, spas, pools and outdoor home working areas.
- * This unit is designed for RESIDENTIAL use only!
- * Always ensure that adequate fresh air ventilation is provided. Follow the **MINIMUM spacing tolerances as indicated AT ALL TIMES!**

- * The installation must conform to local codes, or in the absence of local codes, with the standard for the storage and handling of liquid petroleum gases, ANSI/NFPA 58 or NFPA, ANSIZ 223.1-1998
- * The heater must be placed on stable, level firm ground.
- * Never operate in an explosive atmosphere. Keep away from areas where gasoline or other flammable liquids or vapors are stored or used.



In very strong winds, turn off the heater, turn off the gas cylinder valve and remove the heat reflector hood. Then move the heater to a sheltered location. Do not move heater while it is still hot.

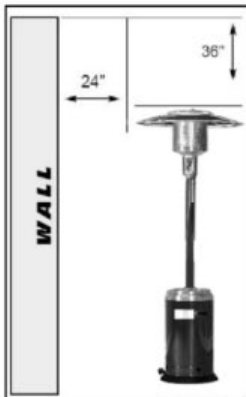

***** IMPORTANT NOTICE *****

- Do NOT return to place of purchase!!!

Please contact our Toll Free Hotline:

(866) 985-7877

E-mail: cservice@welltraveled.net

STEP 8: OPERATION & STORAGE

8-1. OPERATION

1. Open the gas cylinder valve.
2. Turn the control knob half way between the small flame and the large flame symbols.
3. Depress (press down) the control knob and then push the RED igniter button to ignite the main burner, repeat until the main burner ignites. Keep the control knob fully depressed for an additional 30 seconds after the burner ignites, then release the control button.
4. To increase the flame, turn the control knob clockwise. To decrease the flame, turn the control knob counter clockwise.
5. To turn off the appliance: press down the control knob and turn counter clockwise to the off position.
6. Wait 5 minutes before re-lighting the unit.
7. Completely shut off and close gas cylinder valve.

***** IMPORTANT NOTICE *****

Establishing a burner ignition for the **FIRST** time or after changing the cylinder tank may take up to 2-3 minutes in order for the gas to purge through the feeder lines.

*****NOTE: Main burner may also be lit using a MATCH*****

CAUTION: Be aware of gas build-up when lighting with match—especially after holding down control knob. If you smell gas, WAIT 5 minutes for gas to dissipate before lighting.

Manual Lighting: place a sticker lighter thru the large hole at the bottom of the burner unit while following the lighting procedures above.

WARNING: Read the installation, operation, and maintenance instructions thoroughly BEFORE operating, installing or servicing this equipment. Improper use, adjustment, service and/or maintenance can cause serious injury or damage to your property.

Minimum Clearance to adjacent combustible surfaces is as follows:
*Sides - 24" *Top - 36"

The Gas Supply Must be turned "OFF" at the LP Gas Cylinder when this appliance is not in use.

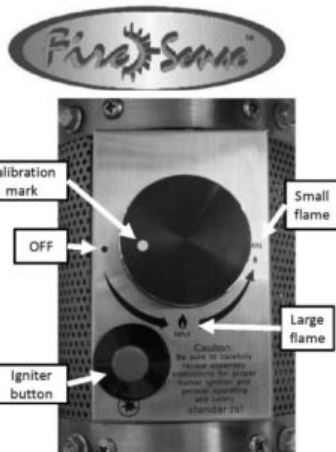

*****THINK SAFETY!*****

After appliance shut down. Do NOT touch or move unit for at least 30 minutes. This allows for proper cooling of heater components.

***** NOTICE *****

During the FIRST TIME use only. It is normal to experience a small amount of smoke coming from the reflector hood. This is due to the burn off of the protective coating applied during the manufacturing process.

***** IMPORTANT NOTICE *****

- Do NOT return to place of purchase!!!

Please contact our Toll Free Hotline:

(866) 985-7877

E-mail: cservice@welltraveled.net



***** BURNER OPERATION *****

* The burner head unit emitter screen will burn bright red when operating normally. The heat generated is VERY INTENSE. Note: It is normal for some discoloration of the emitter screen after use.

* The burner flame will normally show blue with yellow tip flames (see fig.). Should you notice the flame to be predominantly yellow or producing thick black smoke, this is an indication of air flow obstruction. Shut the unit off and check burner and passageways for debris, insects, spider webs and excessive carbon build up. Clean as needed.

HINT: Use a can of compressed air or an air compressor to blow out burner and gas valve areas in the head unit. Spray liberally through vent holes and manual lighting holes.

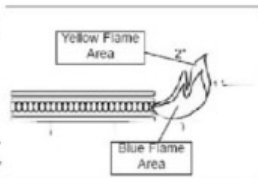

***** WARNING *****



After shutting off appliance,
wait 5 minutes before re-lighting.
There is a built-in safety system designed to prevent immediate re-lighting after use.



When storing the heater, the connection between the propane tank and the heater must be disconnected and the propane tank removed from the enclosure and stored outdoors in a well ventilated area and/or in accordance with Chapter 7 of the Standards for the Storage and Handling of Liquefied Gases - ANSI/NFPA 59-1986.



***** For Your Safety *****

Do NOT store or use gasoline or other liquids or products that produce flammable vapors in the vicinity of this or any other appliance.

8-2. SAFETY HINTS

1. Closing the gas cylinder

Always completely close the gas valve of the gas cylinder after use and for storage.

2. Removing the regulator and hose

Remove the regulator and the hose by turning the nut clockwise.

3. Checking the threads for damage

Check the threads on the cylinder bottle valve for damage. If you suspect damage, replace the unit.

***** IMPORTANT NOTICE *****

- Do NOT return to place of purchase!!!

Please contact our Toll Free Hotline:

(866) 985-7877

E-mail: cservice@welltraveled.net



TROUBLESHOOTING

PROBLEM	PROBABLE CAUSE	SOLUTION
Main Burner Will Not Light 	Gas valve may be OFF Fuel tank empty Orifice blocked Air in supply system Loose connection Ignitor fails Gas pressure low with valve open full New cylinder or 1st time ignition Cylinder valve on, no gas flow	Turn the gas valve ON Refill LPG tank Clean or replace orifice Purge air from lines. Open gas lines & press control knob in for 2-3 min. Check all fittings Use stick lighter to light burner Replace cylinder or regulator Purge air from lines Replace hose/regulator assembly
Low Burner Flame	Pressure is low Tank is low on fuel Gas hose is kinked Control knob at max	Replace cylinder tank Fill LPG tank Check & straighten or replace Check for obstruction at passageways and orifices
Burner Unit	Carbon on reflector & emitter screen Thick black smoke	Clean components as needed Blockage in burner head unit Thoroughly clean burner

***** IMPORTANT NOTICE *****

- Do NOT return to place of purchase!!!

Please contact our Toll Free Hotline:

(866) 985-7877

E-mail: cservice@welltraveled.net



Customer Service

ATTENTION Consumer: Please use the customer service contact information listed below for any questions concerning assembly, care information, warranty issues and/or replacement parts.

To ensure your satisfaction and maintain high standards for quality and workmanship, we want to hear from you should you have any questions or comments. You can contact Fire Sense Outdoor Heaters at (866)985-7877, 9:00am-6:00pm

Eastern Standard Time - Monday thru Friday. Or fax us at (904)261-6769.

Email: cservice@welltraveled.net

Web: www.wtliving.com



Again, thank you for selecting our product line!

Storage & Maintenance

STORAGE:

*** During the season:**

- 1) Control knob must be in "OFF" position.
- 2) Propane cylinder valve must be closed completely.
- 3) Patio heater must be upright and sheltered from any harsh weather conditions (i.e., strong winds, rain, heavy mist, snow, dust & debris).

*** During "off season":**

- 1) Control knob must be in "OFF" position.
- 2) Disconnect LPG cylinder and store in a well ventilated OUTDOOR area where the temperature will not exceed 125 degrees F.
- 3) Appliance should be upright and sheltered from outside weather conditions (i.e. rain, snow, hail, winds, dust, debris).
- 4) It is recommended that the "head components" be wrapped or covered to protect against debris, dust and insects clogging air and gas passageways. Suggestion: use a poly trash can liner or poly tarp material.

Maintenance

* **Outside Metal Surface** - Clean with warm soapy water and soft rags or paper towels. Do NOT use abrasive or corrosive cleaning agents. Be careful NOT to wet the burner or pilot ignition assemblies. Do NOT spray water or cleaning agents directly onto the head components as severe damage may result.

* **The aluminum reflector hood** MUST be cleaned frequently. Do NOT allow carbon deposits to build. This will cause a significant fire hazard. Use warm soapy water or a non-abrasive solution and soft rags or paper towels.

* **Obstruction of airflow & gas passageways** is the primary cause of problems. Check burner assembly, ventilation screen, control panel and intake lines before every use. Clean orifices and small vents with a pipe cleaner. A can of compressed air is very effective for clearing out small particles, insects, and spiders.

* Possible signs of obstructed air and gas passageways:

- 1) Heat glow on head component is very UNEVEN
- 2) Smell of gas and extreme yellow tipping of flame
- 3) Heating output (BTU) is noticeably reduced
- 4) Crackling or popping noises coming from heating components

NOTE: Locations near the ocean or saltwater will require more maintenance and frequent checking of components.



Product developments and enhancements are continual and ongoing at Fire Sense, Well Traveled Living. We reserve the right to change specifications or design without notice

Well Traveled Imports, Inc.
(866) 965-7877
Email: cservice@welltraveled.net
Website: www.wtliving.com

1 YEAR LIMITED WARRANTY - Customers in the Continental US

All components are warranted for a period of 1 year after date of purchase by the original owner against defects in materials and workmanship under normal use. This warranty does NOT cover normal wear and weathering, assembly and/or maintenance. At Well Traveled Living's sole discretion, products under warranty will be repaired and/or replaced at no charge to the customer. Any returns sent back to the manufacturer must be sent via prepaid freight.

***** Insure prompt warranty service, return the enclosed warranty registration card within 30 days ******

** For warranty service contact Well Traveled Living at the address, phone numbers or internet site and e-mail listed in this owner's manual. Be sure to have your sales receipt and original date of purchase. All warranty service will be coordinated by the Well Traveled Living, Amelia Island Florida service center.

This warranty is extended only to the original purchaser. Proof of purchase will be required before warranty service is rendered. Sales receipt and/or validation of warranty registration are valid forms of proof of purchase. This warranty only covers failures due to defects in materials or workmanship which occur during normal use. Failures and/or damage which result from accident, negligence, misuse, abuse, neglect, mishandling, alteration or modification, failure to maintain, improper assembly or maintenance, service by an unauthorized agency or use of unauthorized components or damage that is attributable to acts of God are NOT covered.

*** There are no express warranties except as listed above ***

Purchaser assumes all risks in the assembly and operation of this unit.

FAILURE TO FOLLOW WARNINGS & OPERATIONAL INSTRUCTIONS CONTAINED IN THIS MANUAL CAN RESULT IN SEVERE PROPERTY DAMAGE AND/OR PERSONAL INJURY.

Well Traveled Living shall not be liable for incidental or consequential damages resulting from the use of this product or such damages arising out of any breach of this warranty. Some states do not allow the exclusion or limitation of incidental or consequential damages, or limitations on how long an implied warranty lasts, so the above exclusions or limitations may not apply to you. This warranty gives you specific legal rights.

You may also have other legal rights which vary from state to state.

*Fire Sense is a registered trademark of Well Traveled Imports, Inc.
Fire Sense Assembly Instruction publications are properties of Well Traveled Imports, Inc. and are protected by US Copyrights and Trademarks.
All Rights Reserved*