





Features:

- Cast brass valve
- Controls On/Off and Volume functions for a single shower component in a shower system
- 1/2" and 3/4" NPT available
- Available in Cross or Lever Handle

Pictured:

842/820 Wall Valve with Lever Handle

Description	Handle Type	Product Number
1/2" Wall Valve	Cross	842/O20
1/2" Wall Valve	Lever	842/820 
3/4" Wall Valve	Cross	842/O22
3/4" Wall Valve	Lever	842/822 

Available Finishes	Finish Code
Polished Chrome	100
Brushed Nickel	144
Platinum Nickel	150

Rough & Trim Options	Handle Type	Product Number
Trim Only	Cross	842/720
Trim Only	Lever	842/722 
Rough Only - 1/2" Wall Valve		865/O01/191
Rough Only - 3/4" Wall Valve		865/101/191

Extension Kit	Product Number
Stem Extension Kit	H960764.191
Stem Extension Kit Cover	H960202

ROUGH-IN DIAGRAM
SHOWN ON REVERSE SIDE

Handle Options:

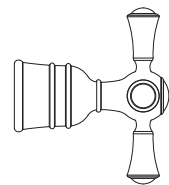

Cross Handle

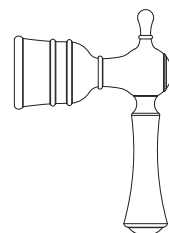

Lever Handle



CODES & STANDARDS

These products meet and exceed the following codes and standards:

- ASME A112.18.1
- CSA B125.1

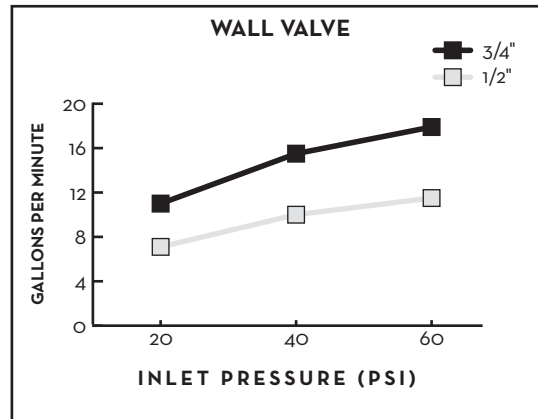

 Meets the American Disabilities Act Guidelines and **ANSI A117.1** Requirements for the physically challenged.

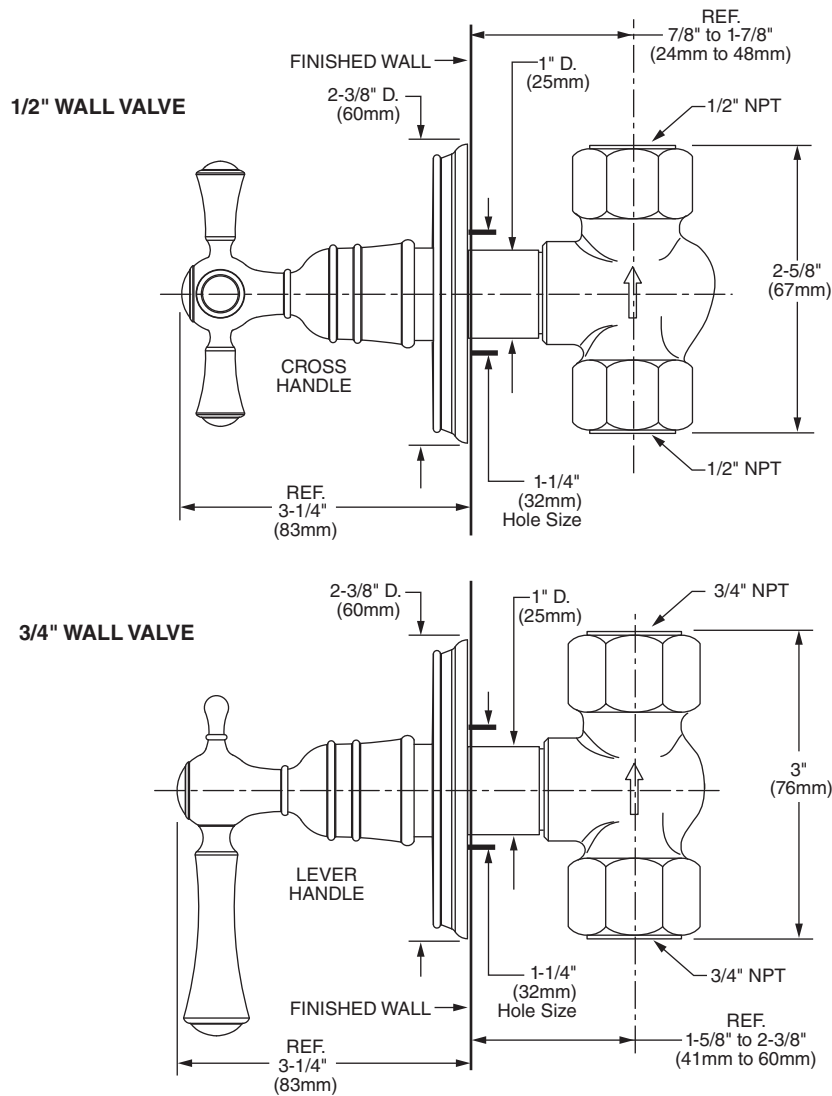

IMPORTANT: These measurements are subject to change or cancellation. No responsibility is assumed for use of superseded or voided pages.