

## ASSEMBLY AND INSTALLATION INSTRUCTIONS

1. Turn the power off at source.
2. Take threaded pipe from parts bag and screw in screw collar loop at minimum of 1/4". Lock into place with hex nut.
3. Run another hex nut down threaded pipe almost touching first hex nut. Now screw threaded pipe into mounting strap. Mounting strap must be positioned with extruded thread faced into outlet box, Threaded pipe must protrude out the back of mounting strap, Connect mounting strap to outlet box
4. Unscrew the threaded ring from screw collar loop. Take canopy and pass over screw collar loop. Approximately one half of the screw collar loop exterior threads should be exposed. Adjust screw collar loop by turning assembly up or down in mounting strap. Remove canopy.
5. After desired position is found, tighten top hex nut up against the bottom of the mounting strap.
6. Take one adjustable chain link, twist open the locking tube and then hook onto fixture loop and onto one end of chain. Close back the locking tube
7. At this point decide how much chain to use, including one additional adjustable chain link at top end, so the fixture hangs at desired height. Spread open the chain link you have decided to remove and discard unused links.
8. Slide color ring and then canopy down the chain.
9. Take another adjustable chain link, twist open the locking tube, and then hook onto top end of chain, Then grabbing onto chain firmly lift fixture and hook the same adjustable chain link into screw collar loop which has been mounted onto ceiling. Close back the locking tube of adjustable chain link.
10. Weave electrical wire and ground wire through chain links no more than 3 inches apart, Pass wire through threaded ring, canopy, screw collar loop, threaded pipe and into outlet box.
11. If fixture is provided with ground wire, connect fixture ground wire and outlet box ground wire securely onto green grounding screw located at mounting strap. Never connect ground wire to black or white power supply wires
12. Make wire connections (connectors not provided) Reference chart below for correct connections and wire accordingly

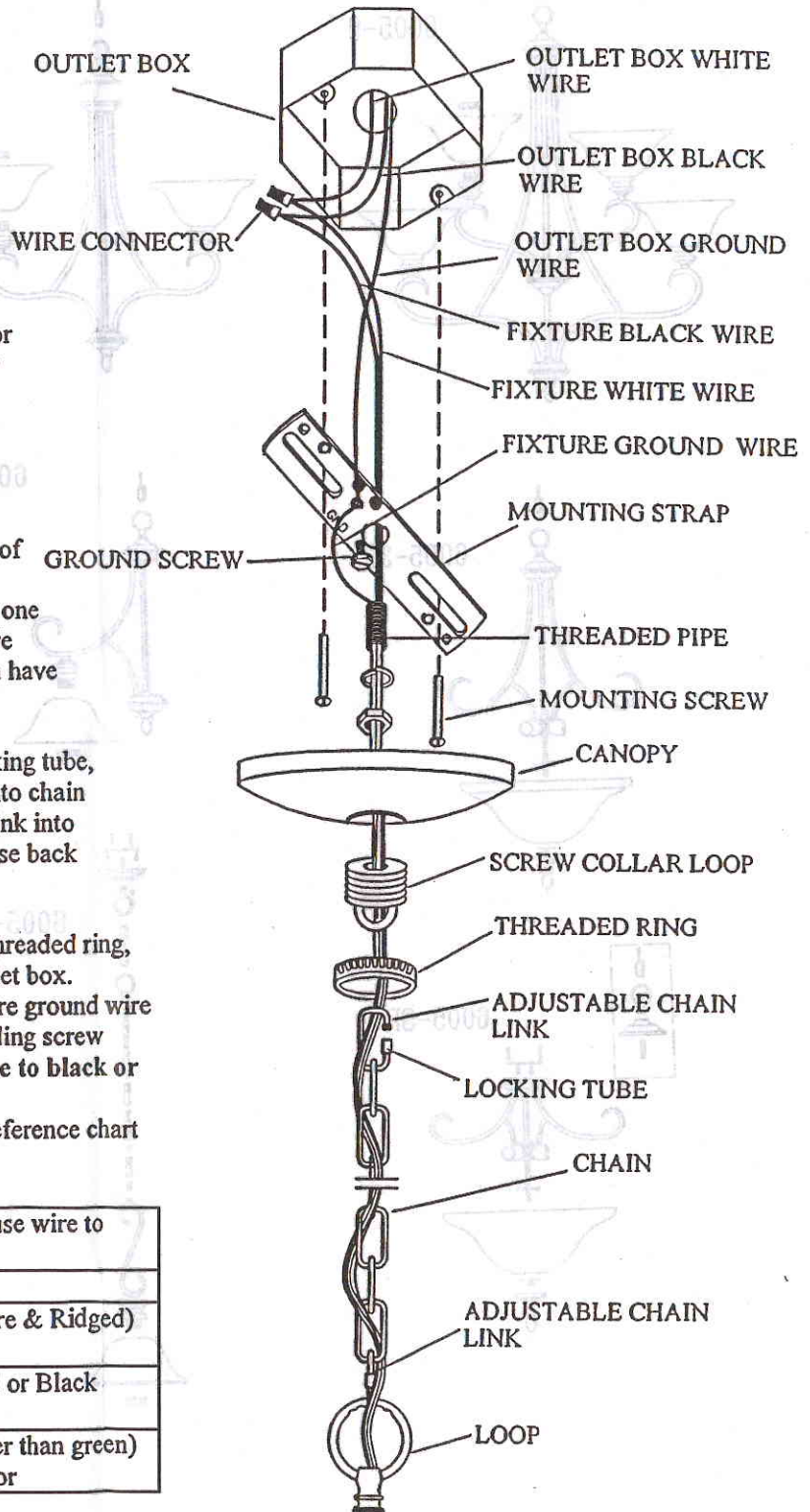

Connect Black or Red House Wire to:	Connect White House wire to
Black	White
*Parallel cord (round & smooth)	Parallel cord (Square & Ridged)
Clear, Brown, Gold or Black without tracer	Clear, Brown, Gold or Black with tracer
Insulated wire (other than green) with copper conductor	Insulated wire (other than green) with silver conductor

Note: when parallel wire (SPT-1 & SPT-2) is used, the neutral wire is square shaped or ridged and the other wire will be round in shape or smooth. )

13. Raise canopy to ceiling
14. Secure canopy in place by tightening threaded ring onto screw collar loop.

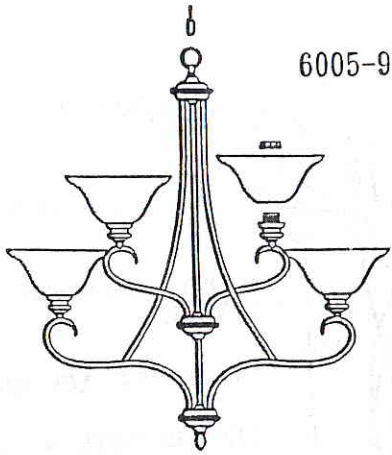

6005-9

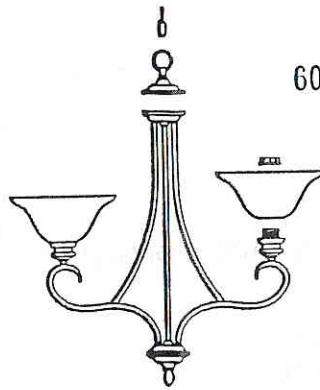

6005-5

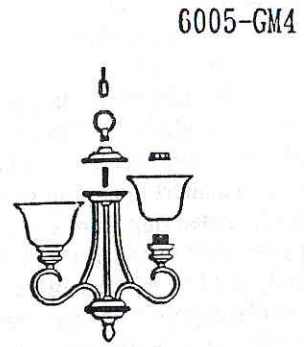

6005-GM4

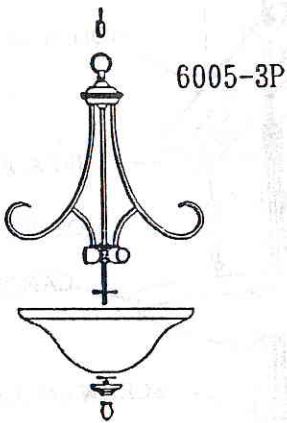

6005-3P

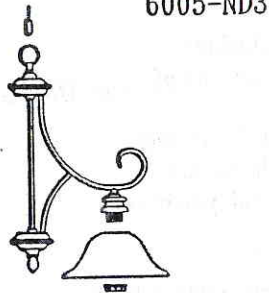

6005-ND3

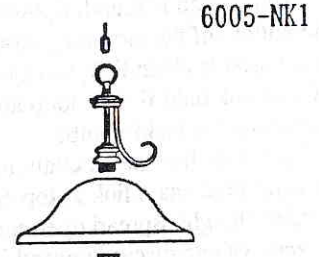

6005-NK1

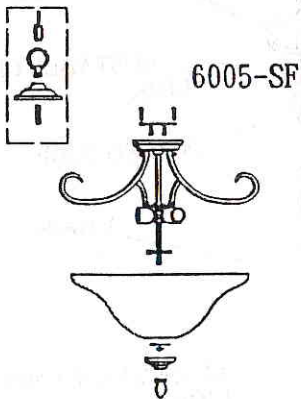

6005-SF



6005-MIL

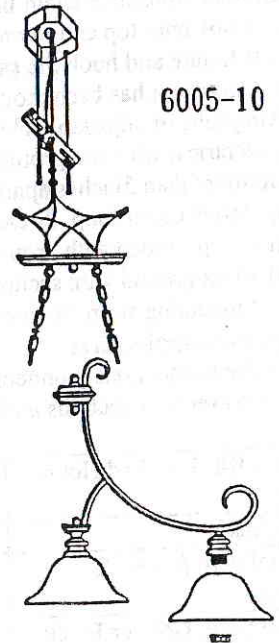

6005-10