

Features

- 36-inch minimum base cabinet width.
- KOHLER cast iron.
- Acid-resistant enamel finish.
- Under-mount.
- Single compartment.
- Three oversized faucet holes with two oversized accessory holes to the right.
- 33" (838 mm) x 22" (559 mm)

Recommended Accessories

K-9000 P-Trap

Optional Accessories

K-6063 Sink Rack
K-6637 Cutting Board
K-8801 Sink Strainer

Components

Additional included component/s: Under-mount sink kit 23" (584 mm).



Codes/Standards













ASME A112.19.1/CSA B45.2

KOHLER® Enameled Cast Iron Kitchen Sink - Lifetime Limited Warranty

See website for detailed warranty information.

Available Color/Finishes

Color tiles intended for reference only.

Color	Code	Description
	0	White
	FF	Sea Salt™
	96	Biscuit
	47	Almond
	FD	Cane Sugar™
	NY	Dune
	95	Ice™ Grey
	G9	Sandbar
	33	Mexican Sand™
	K4	Cashmere
	FT	Basalt
	58	Thunder™ Grey
	20	Suede
	KA	Black 'n Tan
	FP	Caviar
	7	Black Black™

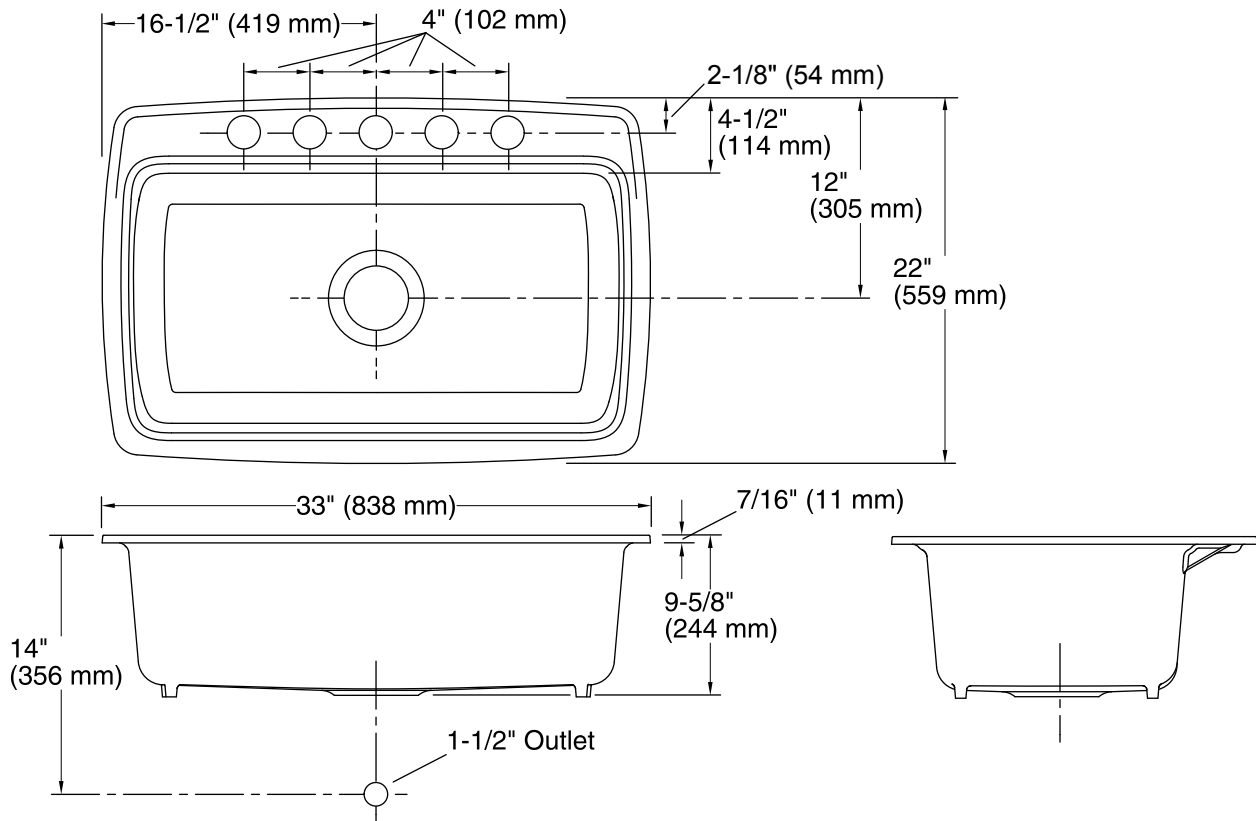

Technical Information

All product dimensions are nominal.

Bowl configuration:	Single
Installation:	Under-mount
Bowl area	Length: 29" (737 mm) Width: 15" (381 mm) Bowl depth: 9" (229 mm)
Number of deck holes:	5
Faucet hole(s):	2-3/8" (60 mm)
Drain hole:	3-5/8" (92 mm)
Template:	Under-mount, 1034873-7, required, included

Notes

Install this product according to the installation instructions.

Faucet holes in under-mount fixture are oversized at $\sim 2\text{-}3/8"$ (60 mm). Drill faucet holes in counter according to fitting roughing-in.