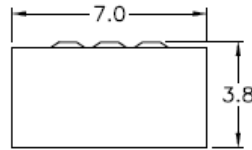
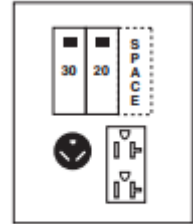


### Top View

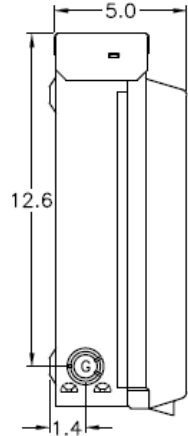


### Configuration

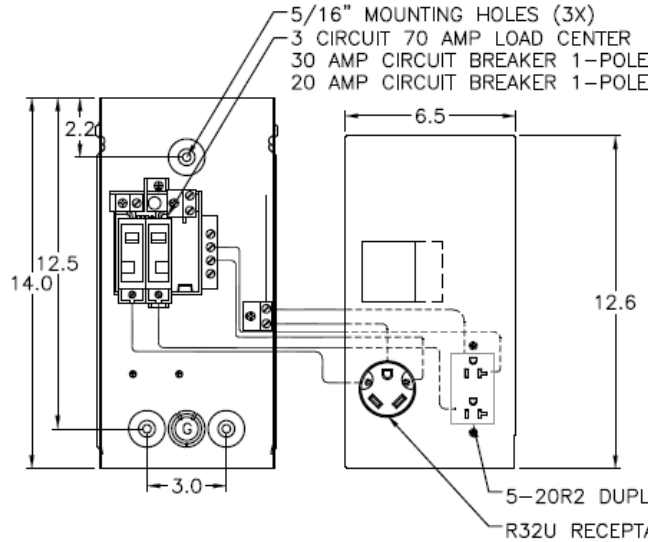


**Fig. B**  
**U041C**  
R32U, 5-20R2

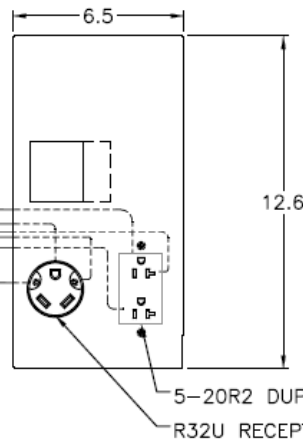
### Front View Interior



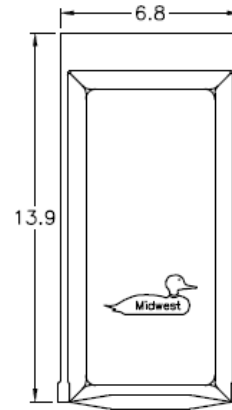
### Front View Inside Cover



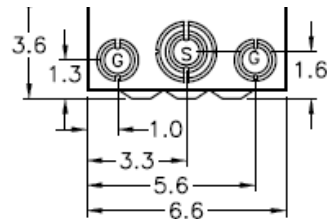
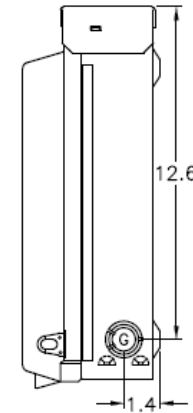
### Front View External # 1



### Front View External # 2



### Side View



### Receptacles

### Circuit Protection

R32U
5-20R2

THQL1120
THQL1130
Space THQL1120

### Wire Range Size

#### WIRE RANGE TABLE:

CONNECTOR	COPPER		ALUMINUM	
	SOLID	STRAND	SOLID	STRAND
LINE	14-8	14-2	12-8	12-2
LOAD	14-10	14-10	-----	-----
NEUTRAL <del>END</del> <sup>ROLE</sup>	14-8	14-2	12-8	12-2
NEUTRAL <del>FREE</del>	14-8	14-4	12-8	12-4
EQUIP. GRND.	12-8	12-2	12-8	12-2

#### KNOCKOUT TABLE:

S= 1/2", 3/4", 1", 1-1/4", 1-1/2" KO
G= 1/2", 3/4", 1" KO



MIDWEST POWER OUTLET UNMETERED SURFACE 70A  
30/20A 120/240V 1PH G90 N3R UL LISTED

CAT NO	DWG DATE	REV #
U041C	10/18/2017	01