

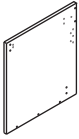

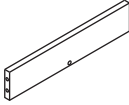

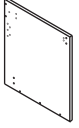

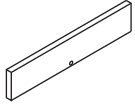

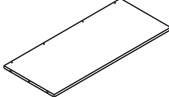
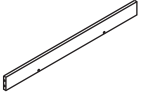
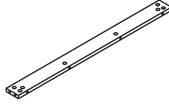
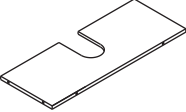
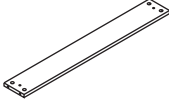
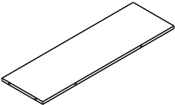
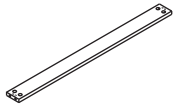
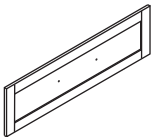
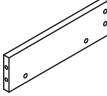
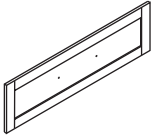
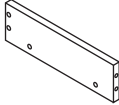
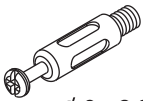
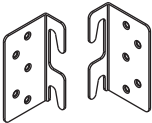

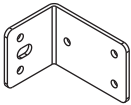
1		x1	9		x1
2		x1	10		x1
3		x1	11		x1
4		x1	12		x1
5		x1	13		x1
6		x1	14		x1
7		x2	15		x1
8		x2			

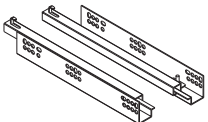
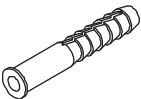
A	 $\varnothing 6 \times 26 \text{mm}$	x54	I		x1
B	 $\varnothing 15 \times 9 \text{mm}$	x54	J		x2
C	 $\varnothing 3.5 \times 14 \text{mm}$	x49	K		x2
D		x4	L		x8
E		x4	M	 $\varnothing 4 \times 20 \text{mm}$	x4
F		x4	N		x2
G		x1	O		x1
H		x2			

Use the Cam Lock and Eccentric Wheel

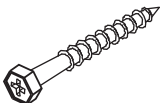
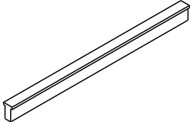
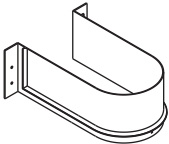
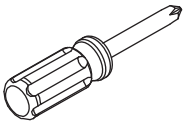
ECCENTRIC WHEEL

Tighten the bolt until the shoulder is aligned with the panel.
Be sure not to tighten too much or too little.

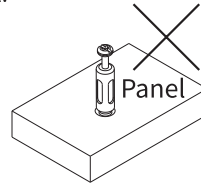
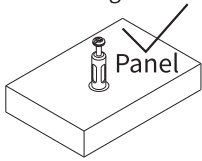

The pre-inserted nut should align with the center of the cam lock when joining two panels. The cam lock should be inserted before the eccentric wheel.

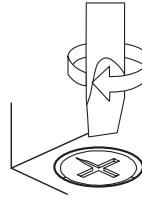
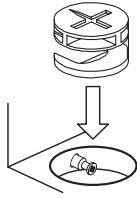

Turn the cam lock clockwise to tighten.

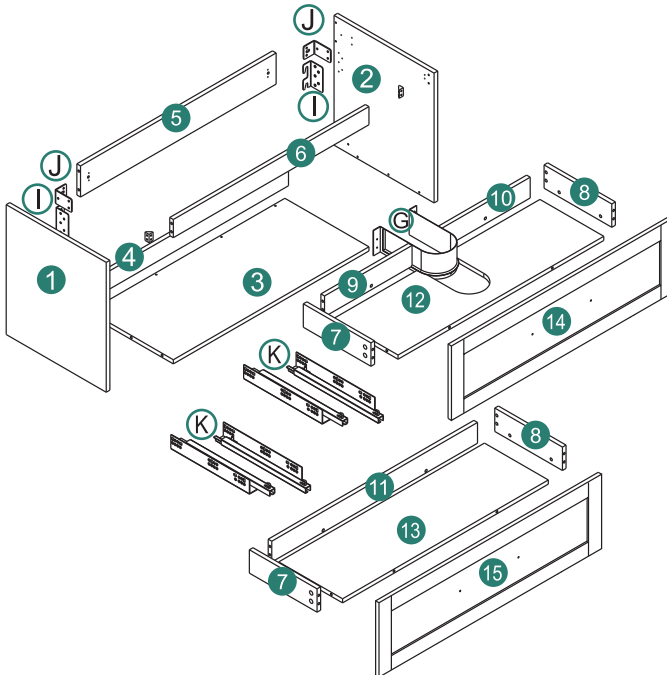

WARNING: To prevent tipping over, this product must be used with the included wall mounting device.
WARNING: Evaluate the suitability of the wall to ensure that the fixtures can withstand the forces that occur.

1

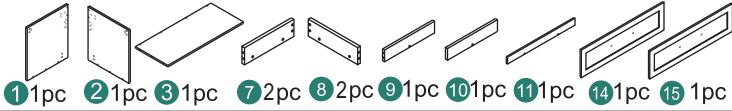

The floor needs to be covered with paper or carpet protective material before installation!

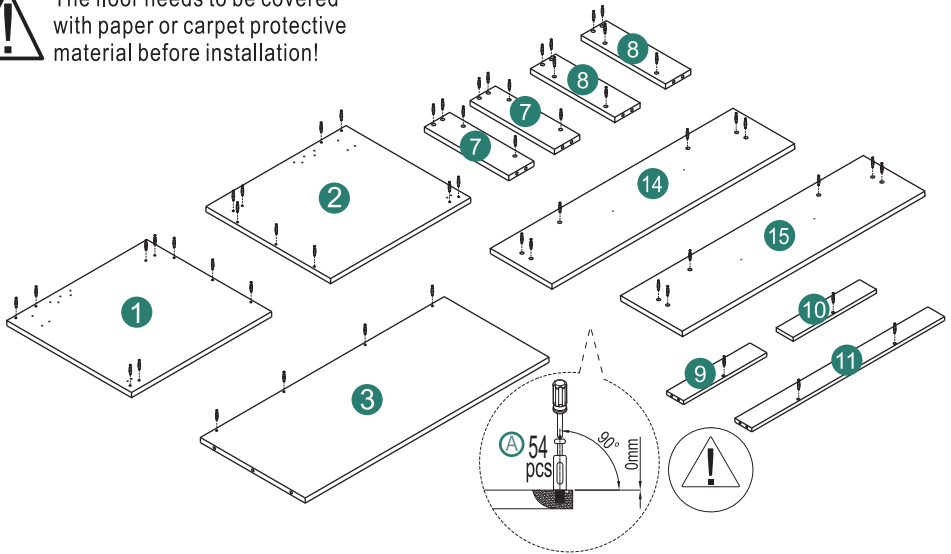

2

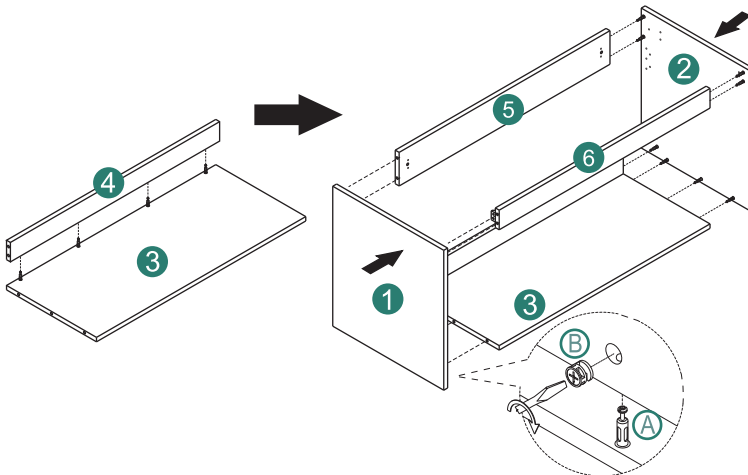
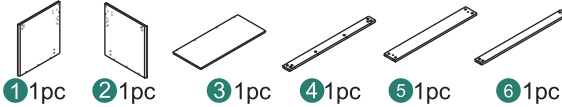

5

3

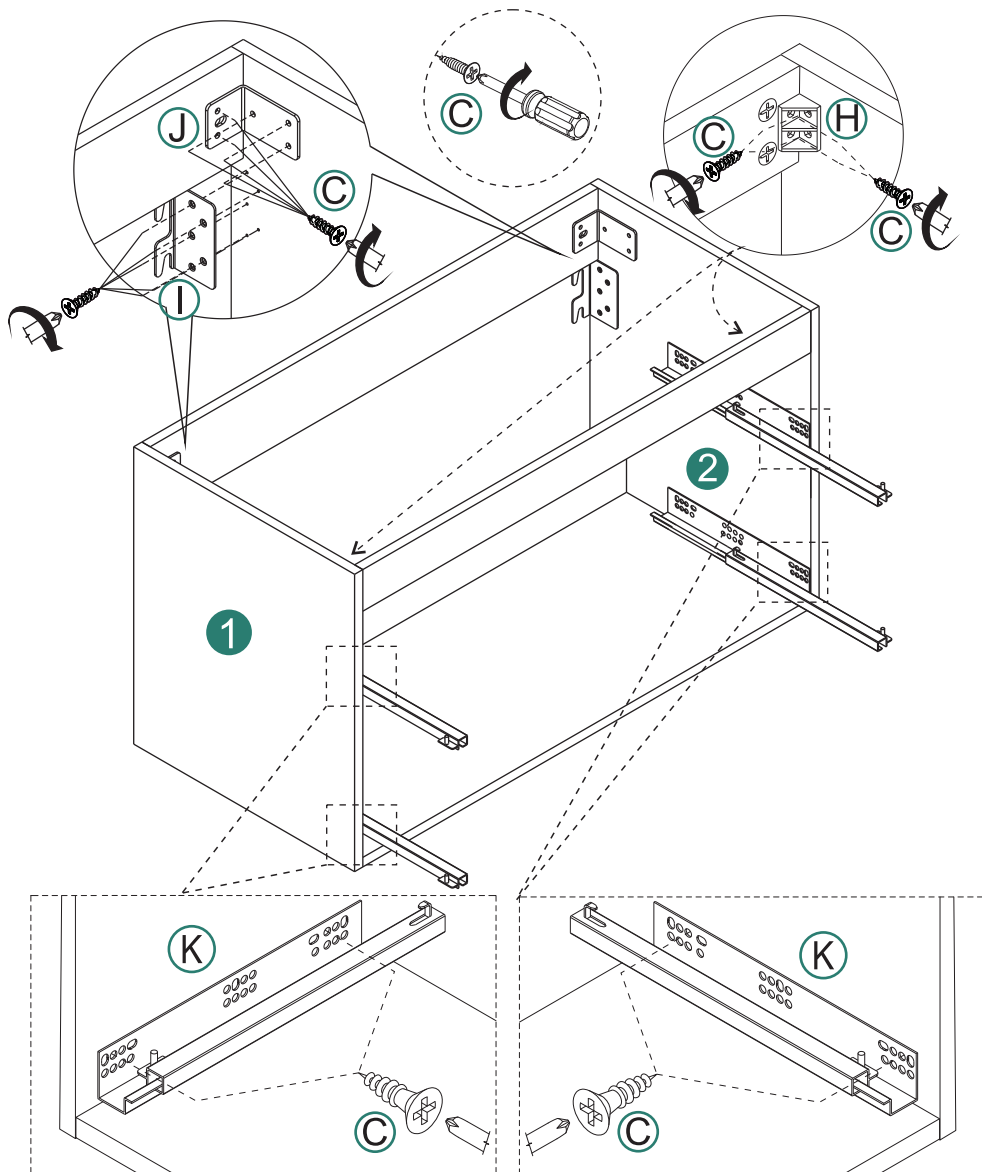

4

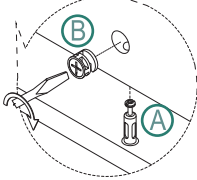
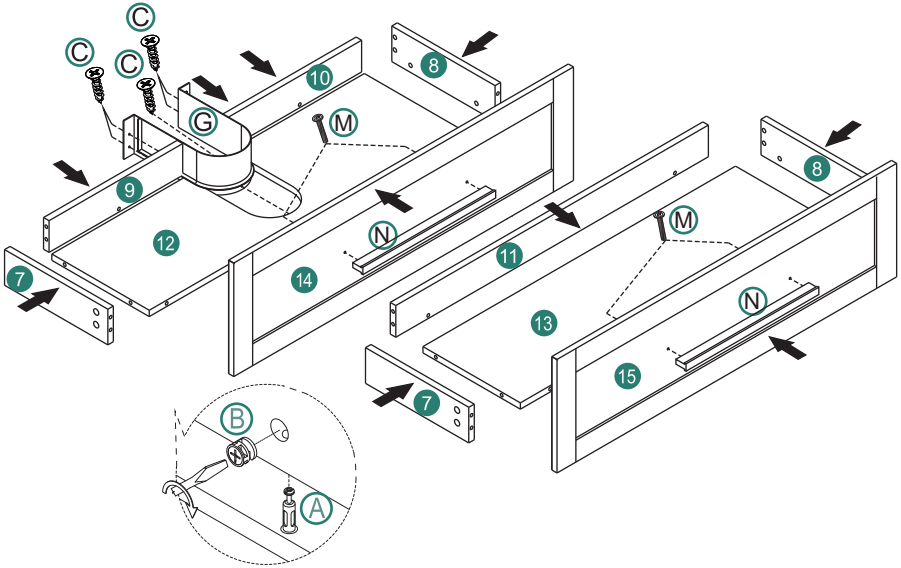
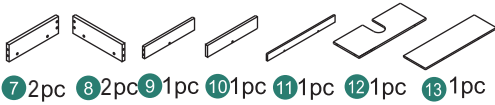

5

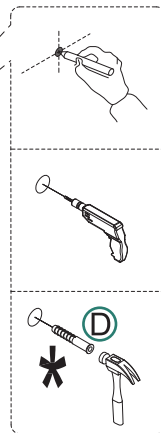
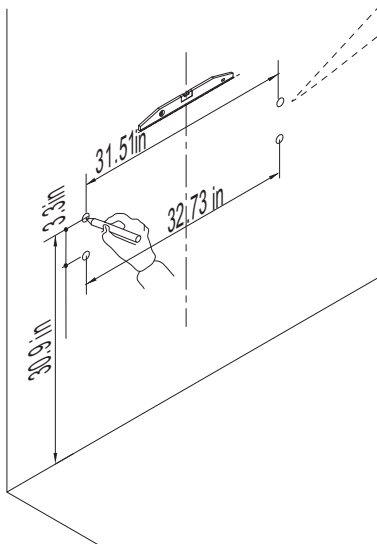

6



Ⓒ 8pcs



Ⓔ 4pca



Ⓕ 4pca



Ⓖ 8pca

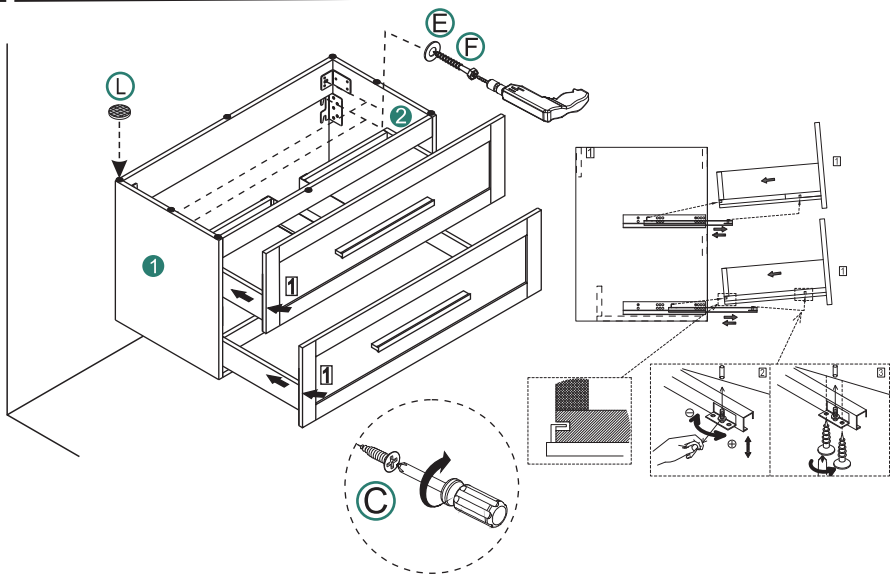

7

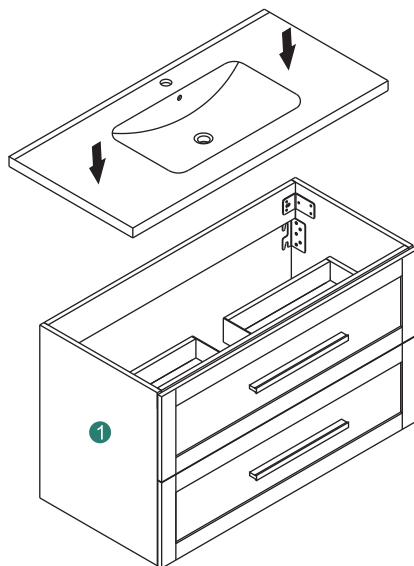

8