











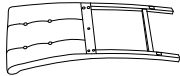

CARE AND MAINTENANCE

Wipe clean with a soft, dry cloth. Test the cleaning method on a hidden area before using them over the entire area.

NOTICE

- * Please make sure that you have all parts indicated before you begin assembly of this item.
- * This item should be assembled on a soft surface to prevent scratching the finished product during assembly.
- * This item may require periodic tightening.
- * Do not tighten bolts until completely assembled.

Part List and Hardware List

PIECE	DESCRIPTION	PICTURE	QUANTITY
A	Chair Back		1x
B	Seat Cushion		1x
C	L/Front Leg		1x
D	R/Front Leg		1x
E	Front Stretcher		1x
F	Left Stretcher		1x
G	Right Stretcher		1x
H1	Bolt	 $\phi 5/16'' \times 3-1/2''$	4x
H2	Bolt	 $\phi 5/16'' \times 2-1/2''$	4x
H3	Bolt	 $\phi 5/16'' \times 2''$	1x
H4	Wrench	 5/16"	1x
H5	Screw		6x

SAFAVIEH FURNITURE

Model# BST6300

Product Dimensions: 20"W*26-1/2"Dx44-1/2"H

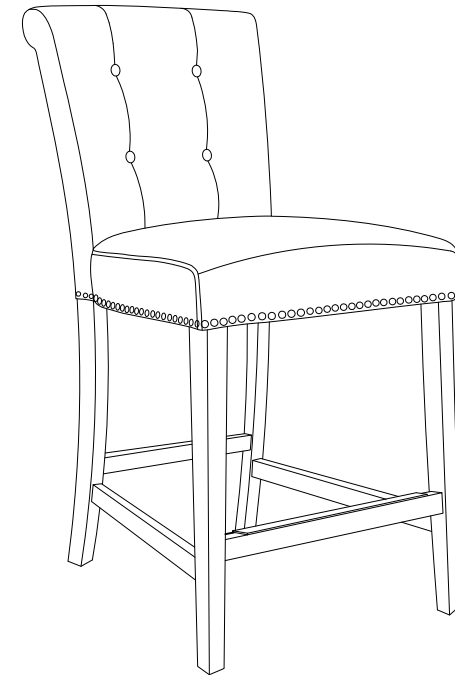

Weight capacity: 275lbs
WARNING: DO NOT STAND ON THE CHAIR

PREPARATION

Before beginning assembly of product, make sure all parts are present. Compare parts with package contents list and hardware contents list. If any part is missing or damaged, do not attempt to assemble the product.

Estimated Assembly Time: 15 minutes.

Tools Required for Assembly : Wrench (included) and Philips head screwdriver (not included)

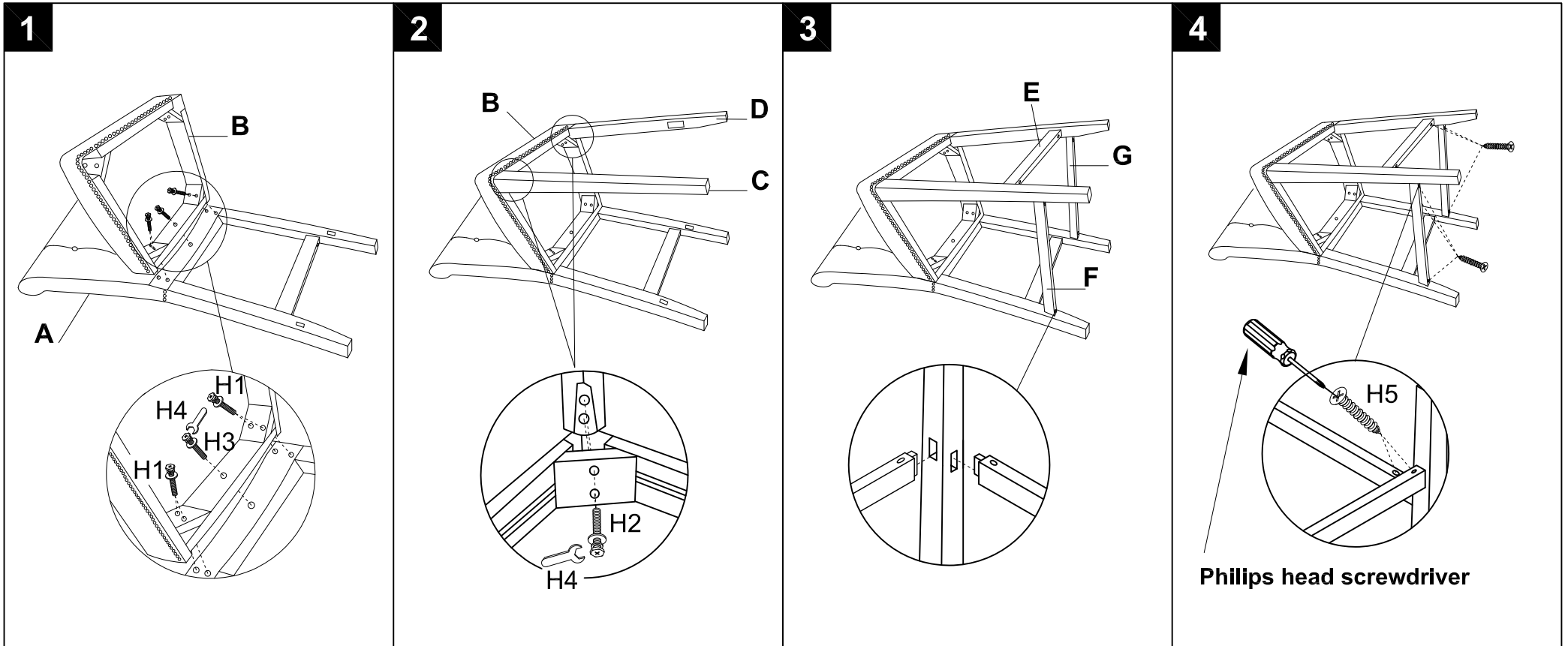

Step 1:
Assemble seat cushion (B) with chair back (A). Using Wrench (H4) to lock with 5*bolts (1*H3 & 4*H1).

Step 2:
Assemble front legs (C & D) with seat cushion (B). Using Wrench (H4) to lock with 4*bolts(H2).

Step 3:
Assemble 3 stretchers (E · F & G) with the front and back legs.

Step 4:
Lock the 3 stretchers tight with legs, Use Philips head screwdriver (tool is not included) to lock 6*screws (H5), as picture. Straighten up the assembled chair, Assembly is completed.