



## **Electric Induction Cooktop Instruction For Installation And Use**

**Model: IH30BFH  
IH77BFH**

Important! Read these instructions for installation and use carefully. Keep these instructions for future reference. Any questions regarding the operation, maintenance service or warranty of the appliance should be directed to GASLAND chef.

---

📍 3330-A Marathon Ct Charleston, SC 29418

☎ (844) 538-7890

✉ support@gaslandchef.com

🌐 [www.gaslandchef.com](http://www.gaslandchef.com)



**GASLAND**  
chef



**1**

## Safety Warning

Your safety is important to us. Please read this information before using your cooktop.

## Installation Electrical Shock Hazard

- Disconnect the appliance from the mains electricity supply before carrying out any work or maintenance on it.
- Connection to a good earth wiring system is essential and mandatory.
- Alterations to the domestic wiring system must only be made by a qualified electrician.
- Failure to follow this advice may result in electrical shock or death.

## Cut Hazard

- Take care - panel edges are sharp.
- Failure to use caution could result in injury or cuts.

## Important Safety Instructions

- Read these instructions carefully before installing or using this appliance.
- No combustible material or products should be placed on this appliance at any time.
- Please make this information available to the person responsible for installing the appliance as it could reduce your installation costs.
- In order to avoid a hazard, this appliance must be installed according to these instructions for installation.
- This appliance is to be properly installed and earthed only by a suitably qualified person.
- This appliance should be connected to a circuit which incorporates an isolating switch providing full disconnection from the power supply.
- Failure to install the appliance correctly could invalidate any warranty or liability claims.

## Operation And Maintenance Electrical Shock Hazard

- Do not cook on a broken or cracked cooktop. If the cooktop surface should break or crack, switch the appliance off immediately at the mains power supply(wall switch) and contact a qualified technician.
- Switch the cooktop off at the wall before cleaning or maintenance.
- Failure to follow this advice may result in electrical shock or death.



## Health Hazard

- This appliance complies with electromagnetic safety standards.
- However, persons with cardiac pacemakers or other electrical implants (such as insulin pumps) must consult with their doctor or implant manufacturer before using this appliance to make sure that their implants will not be affected by the electromagnetic field.
- Failure to follow this advice may result in death.

## Hot Surface Hazard

- During use, accessible parts of this appliance will become hot enough to cause burns.
- Do not let your body, clothing or any item other than suitable cookware contact the induction glass until the surface is cool.
- Metallic objects such as knives, forks, spoons and lids should not be placed on the cooktop surface since they can get hot.
- Keep children away.
- Handles of saucepans may be hot to touch. Check saucepan handles do not overhang other cooking zones that are on. Keep handles out of reach of children.
- Failure to follow this advice could result in burns and scalds.

## Cut Hazard

- The razor-sharp blade of a cooktop scraper is exposed when the safety cover is retracted. Use with extreme care and always store safely and out of reach of children.
- Failure to use caution could result in injury or cuts.

## Important Safety Instructions

- Never leave the appliance unattended when in use. Boil over causes smoking and greasy spillovers that may ignite.
- Never use your appliance as a work or storage surface.
- Never leave any objects or utensils on the appliance.
- Do not place or leave any magnetisable objects (e.g. credit cards, memory cards) or electronic devices (e.g. computers, MP3 players) near the appliance, as they may be affected by its electromagnetic field.
- Never use your appliance for warming or heating the room.
- After use, always turn off the cooking zones and the cooktop as described in this manual (i.e. by using the touch controls). Do not rely on the pan detection feature to turn off the cooking zones when you remove the pans.
- Do not allow children to play with the appliance or sit, stand, or climb on it.
- Do not store items of interest to children in cabinets above the appliance. Children climbing on the cooktop could be seriously injured.



**3**

- Do not leave children alone or unattended in the area where the appliance is in use.
- Children or persons with a disability which limits their ability to use the appliance should have a responsible and competent person to instruct them in its use. The instructor should be satisfied that they can use the appliance without danger to themselves or their surroundings.
- Do not repair or replace any part of the appliance unless specifically recommended in the manual. All other servicing should be done by a qualified technician.
- Do not use a steam cleaner to clean your cooktop.
- Do not place or drop heavy objects on your cooktop.
- Do not stand on your cooktop.
- Do not use pans with jagged edges or drag pans across the induction glass surface as this can scratch the glass.
- Do not use scourers or any other harsh abrasive cleaning agents to clean your cooktop, as these can scratch the induction glass.
- If the supply cord is damaged, it must be replaced by the manufacturer, its service agent or similarly qualified persons in order to avoid a hazard.
- This appliance is intended to be used in household and similar applications such as staff kitchen areas in shops, offices and other working environments, farm houses, by clients in hotels, motels and other residential type environments, bed and breakfast type environments.
- **WARNING:** The appliance and its accessible parts become hot during use. Care should be taken to avoid touching heating elements. Children less than 8 years of age shall be kept away unless continuously supervised.
- This appliance can be used by children aged from 8 years and above and persons with reduced physical, sensory or mental capabilities or lack of experience and knowledge if they have been given supervision or instruction concerning use of the appliance in a safe way and understand the hazards involved.
- Children shall not play with the appliance. Cleaning and user maintenance shall not be made by children without supervision.
- **WARNING:** Unattended cooking on the cooktop with fat or oil can be dangerous and may result in fire. Never try to extinguish a fire with water, but switch off the appliance and then cover flame with a lid or a fire blanket.
- **WARNING:** Danger of fire: do not store items on the cooking surfaces.
- **WARNING:** If the surface is cracked, switch off the appliance to avoid the possibility of electric shock.
- A steam cleaner is not to be used.
- The appliance is not intended to be operated by means of an external timer or separate remote-control system.
- **CAUTION:** The cooking process has to be supervised. A short term cooking process has to be supervised continuously.
- **WARNING:** In order to prevent tipping of the appliance, this stabilizing means must be installed. Refer to the instructions for installation.
- **WARNING:** Use only cooktop guards designed by the manufacturer of the cooking appliance or indicated by the manufacture of the appliance in the instruction for use as suitable or cooktop guards incorporated in the appliance. The use of inappropriate guards can cause accidents. This appliance incorporates an earth connection for functional purposes only.

## Congratulations

On the purchase of your new Induction cooktop. We recommend that you spend some time to read this user manual in order to fully understand how to install correctly and operate it. For installation, please read the installation section. Read all the safety instructions carefully before use and keep this user manual for future reference.



## Product Overview

### Top view(IH30BFH)

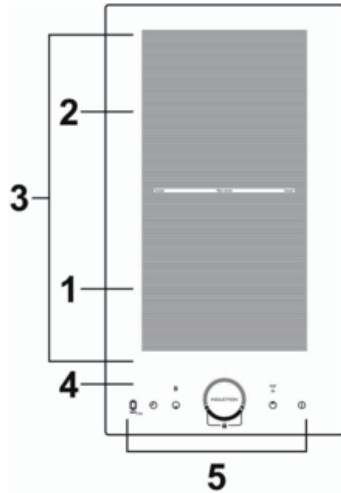

- 1. 2000W cook zone, boost 2300W
- 2. 1500W cook zone, boost 1800W
- 3. Flex zone
- 4. Glass plate
- 5. Control panel

### Control panel(IH30BFH)

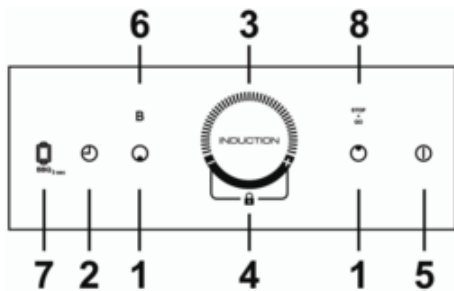

- 1. Heating zone selection controls
- 2. Timer control
- 3. Power/Timer regulating controls
- 4. Keylock control
- 5. ON/OFF control
- 6. Boost control
- 7. Flex zone control & BBQ control
- 8. STOP+GO



**5**

**Top view(IH77BFH)**

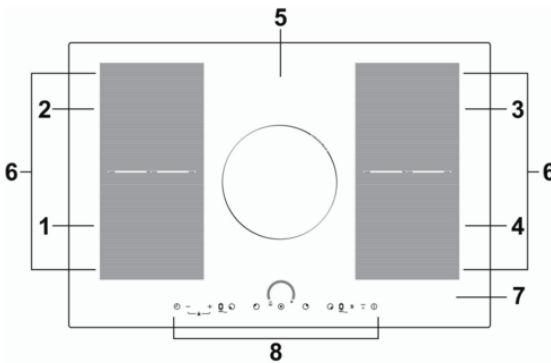

- 1. 2000W zone, boost to 2600W
- 2. 1500W zone, boost to 2000W
- 3. 2000W zone, boost to 2600w
- 4. 1500W zone, boost to 2000W
- 5. 2000W zone, boost to 2600W
- 6. 2500W flex zone, boost to 2800W
- 7. Glass plate
- 8. Control panel

**Control panel(IH77BFH)**

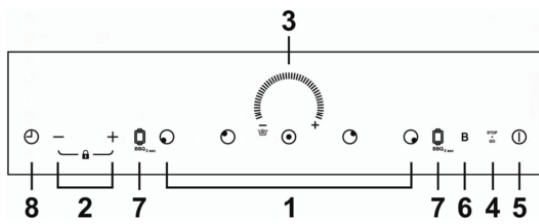

- 1. Heating zone selection controls
- 2. Timer control & Keylock control
- 3. Power level control & keep warm
- 4. STOP+GO
- 5. ON/OFF control
- 6. Boost function control
- 7. Flex zone & BBQ control
- 8. Time indicator

**A Word On Induction Cooking**

Induction cooking is a safe, advanced, efficient, and economical cooking technology. It works by electromagnetic vibrations generating heat directly in the pan, rather than indirectly through heating the glass surface. The glass becomes hot only because the pan eventually warms it up.

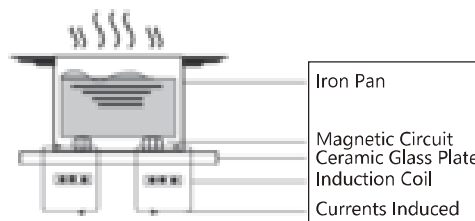

## Before Using Your New Induction Cooktop

- Read this guide, taking special note of the "Safety Warning" section.
- Remove any protective film that may still be on your induction cooktop.

## Using The Touch Controls

- The controls respond to touch, so you don't need to apply any pressure.
- Use the ball of your finger, not its tip.
- You will hear a beep each time a touch is registered.
- Make sure the controls are always clean, dry, and that there is no object (e.g. a utensil or a cloth) covering them. Even a thin film of water may make the controls difficult to operate.



## Choosing The Right Cookware

- Use only cookware with a base suitable for induction cooking. Look for the induction symbol on the packaging or on the bottom of the pan.
- You can check if your cookware is suitable by carrying out a magnet test. Move a magnet towards the base of the pan. If it is attracted, the pan is suitable for induction cooking.
- If you do not have a magnet:
  1. Put some water in the pan you want to check.
  2. If  does not flash in the display and the water is heating, the pan is suitable.
- Cookware made of the following materials is not suitable: pure stainless steel, aluminium or copper without a magnetic base, glass, wood, porcelain, ceramic, and earthenware.



Do not use cookware with jagged edges or a curved base.



Ensure the bottom of your pan is smooth, rests flat against the glass and is level with the cooking zone. Use pans with a diameter larger than the outline of the zone selected. Using a slightly wider pan produces maximum efficiency. If you use a smaller pan, efficiency might be less than desired. A pan of less than 5 1/2 in might not be detected by the cooktop. Always centre your pan on the cooking zone.



7

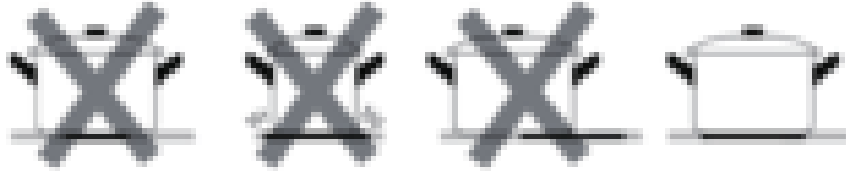

Always lift pans off the induction cooktop. Do not slide them, or they may scratch the glass.

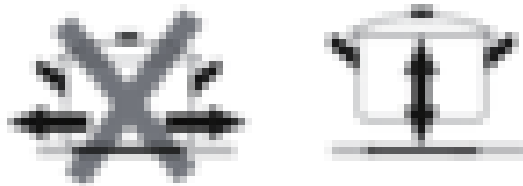

### Pan Dimensions

The cooking zones are up to a limit, automatically adapted to the diameter of the pan. However the bottom of this pan must have a minimum of diameter according to the corresponding cooking zone. To obtain the best efficiency of your cooktop, please place the pan in the centre of the cooking zone.



The Base Diameter Of Induction Cookware	
Cooking Zone Diameter(mm/in)	Minimum Base Diamete Of Cookware(mm/in)
160/6.5	100/4.0
180/7.0	120/4.8
210/8.5	140/5.5
280/110	180/7.0
Flex zone	200/8.0





## Using Your Induction Cooktop

### To start cooking

1. Touch the  control, after power on, the buzzer beeps once, all displays show  or , indicating that the induction cooktop has entered the state of standby mode.
2. Place a suitable pan on the cooking zone that you wish to use.
  - Make sure the bottom of the pan and the surface of the cooking zone are clean and dry.
3. Touch the heating zone selection control, the indicator next to the key will flash.
4. Select a heat setting by touching and sliding along the dotted line towards right.
  - If you don't choose a heat setting within 1 minute, the induction cooktop will automatically switch off. You will need to start again at step 1.
  - You can modify the heat setting at any time during cooking.



### If the display flashes alternately with the heat setting

This means that:

- you have not placed a pan on the correct cooking zone or,
- the pan you're using is not suitable for induction cooking or,
- the pan is too small or not properly centered on the cooking zone.

No heating will take place unless there is a suitable pan on the cooking zone.

The display will automatically turn off after 1 minutes if no suitable pan is placed on it.



**9**

**When you have finished cooking**

1. Touch the heating zone selection control that you wish to switch off.



2. Turn the cooking zone off by sliding along the — to the left point.



Make sure the power display shows 0, then shows H.

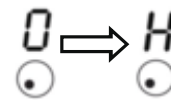

3. Turn the whole cooktop off by touching the 0 control.



4. Beware of hot surfaces

H will show which cooking zone is hot to touch. It will disappear when the surface has cooled down to a safe temperature. It can also be used as an energy saving function if you want to heat further pans, use the hotplate that is still hot.



**Using The Boost**

Boost is the function that one zone rising to a larger power in one second and lasting for 5 minutes. Thus you can get a more powerful and faster cooking.

**Using the boost to get larger power**

1. Touch the heating zone selection control that you wish to boost, an indicator next to the key will flash.



2. Touch the **B** control, the heating zone will begin to work at boost mode.  
The power display will show **P** to indicate that the zone is boosting.

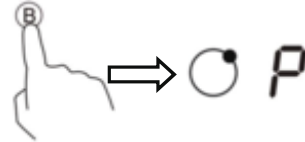

3. The boost power will last for 5 minutes and then the zone will go back to the power stage which was set before boost.



4. If you want to cancel the boost during this 5 minutes, touch the heating zone selection control, an indicator next to the key will flash. And then touch the **B** control. The heating zone will go back to the power stage which was set before boost.



### Power management for IH30BFH

In this cooktop every zone can work with boost function. If you need to use boost, first make sure that the other zone is at the maximum power level of 5. Otherwise the **P** and **5** symbols will flash on the display of the selected zone and power level is **5** automatically set.

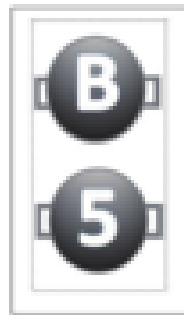
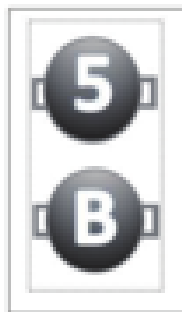

**11**

**Power management for IH77BFH**

In this cooktop every zone can work with boost function.

1. In group a, if you need to use boost please decrease the power level of the other zone in the same group to 5 or less first, otherwise P and 9 symbols will flash on the display of the selected zone and power level 9 is set automatically. When one zone is on boost P and the other one is on power level 5, if you want to increase the power level from 5 to P, then the other zone will decrease the power level from P to 5 automatically.

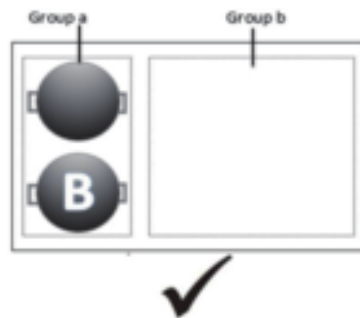

2. In group b, if you need to use boost, you can only use two zones on right at the same time. When you active one zone to boost, you have to decrease the power level of the other zone in the same group to 5 or less first. Otherwise the P and 9 symbols will flash on the display of the selected zone and power level 9 is automatically set. If middle zone use boost function, the other 2 zones set level 0.

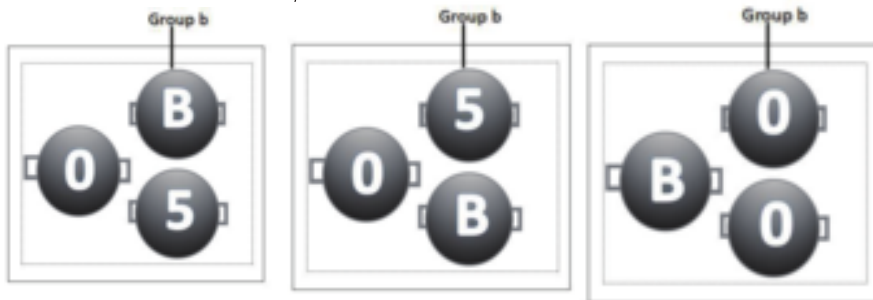

3. In group b, you can use three zones at the same time if you don't active the boost, but the max. power level collocation is 7-level, 7-level, 7-level.

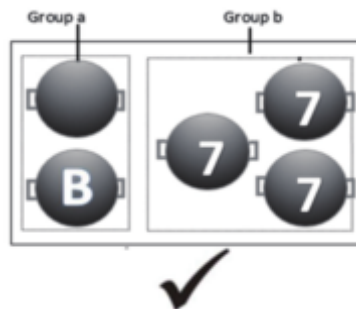

## Flex Zone

This area can be used as a single zone or as two different zones, accordingly to the cooking needs anytime.

- Flexible area is made of two independent inductors that can be controlled separately. When working as a single zone, a cookware is moved from one zone to the other one within the flexible area keeping the same power level of the zone where the cookware originally was placed, and the part that is not covered by cookware will not heat.
- Important: Make sure to place the cookwares centered on the single cooking zone. In case of big pot, oval, rectangular and elongated pans, make sure to place the pans centered on the cooking zone covering both cross.

Examples for correct and wrong pot placements:

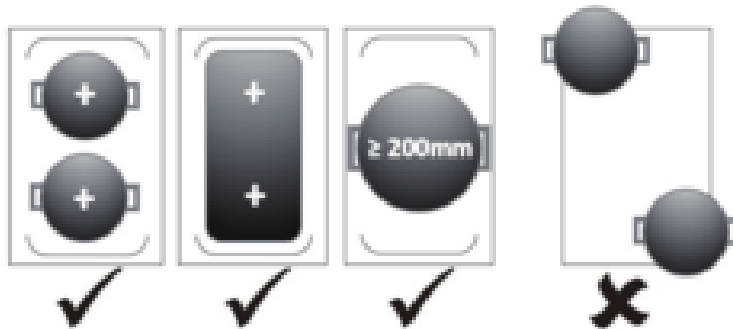

## Using The Barbecue Function

BBQ is the function that used at the flexzone mode which will allow the pan surface temperature stay at a reasonable level.



1. Touch the heating zone selection control that you wish to use BBQ, and the indicator next to the key will flash.

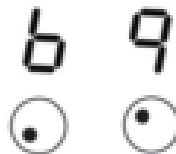

2. Touch the  control and hold for 3 seconds to activate the BBQ function. Then **b** and **9** will be displayed.





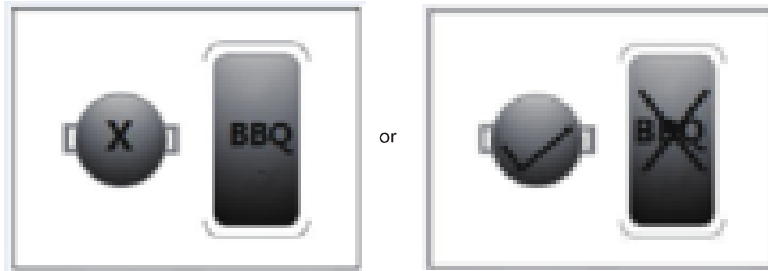

**13**

3. If you want to cancel the barbecue function, touch the heating zone control and  control, the zone will return to power level  and you can reset the power.
4. For the group b, you can't use the zone 5 and BBQ function at the same time. If you select the power of the zone 5, the BBQ function can't be chosen. If you select the BBQ function first and then choose zone 5, the power of zone 5 will be set to 0 automatically.



## Using The Pause Function- STOP+GO

Pause function can be used at any time during cooking. It allows to stop the induction cooktop and come back to work again.

1. Make sure the cook zone is working.
2. Touch the heating zone selection control that you wish to use the pause function, an indicator next to the key will flash.
3. Touch the control , the cooking zone indicator will show . Then the operation of the induction cooktop will be deactivate within the scope of all cooking zones, except the ,  and lock keys.
4. To cancel the pause status, touch the control , then the cooking zone will go back to the power stage which you set before.



## Using The Keep Warm

Keep warm function is suitable for keeping food warm. You can use the keep warm function to get stable temperature

1. Touch the heating zone selection control that you wish to use keep warm, an indicator next to the key will flash.



2. Touch the control — and hold 3s in the meantime, the cooking zone indicator will display **R**.

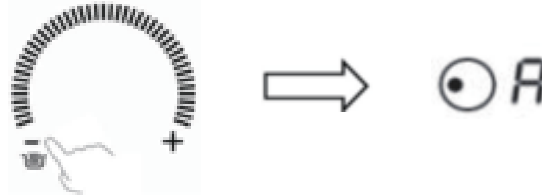

3. If you want to cancel the keep warm, touch the control — and hold 3s in the meantime. The heating zone will go back to **0** power stage.

## Locking The Controls

You can lock the controls to prevent unintended use (for example children accidentally turning the cooking zones on). When the controls are locked, all the controls except the **0** control are disabled.

### To lock and unlock the controls

Touch the **+** and **-** control at the same time. The timer indicator will show **L** and the cooktop is locked. Touch the **+** and **-** of the timer control again to unlock.



IH30BFH

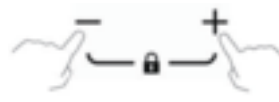

IH77BFH



When the cooktop is in the lock mode, all the controls are disabled except the **0** control. You can always turn the induction cooktop off with the **0** control in an emergency, but you shall unlock the cooktop first in the next operation.



**15**

**Protection against overheating**

An integrated temperature sensor measures the temperature inside the induction cooktop. When excessive temperature is measured, the induction cooktop automatically halts its operation.

**Detection of small objects**

When the shape of a pan is not suitable, or if the pan is not magnetic (e.g. made of aluminium), or certain small items (e.g. knife, fork, keys) have been left on the cooktop, the cooktop will automatically switch to standby mode in 1 minute. The fan maintains working for a further minute till the induction cooktop cools.

**Auto shutdown protection**

Automatic stop is a safety protection feature of your induction cooktop. It halts automatically if ever you forget to turn off after your cooking. The default working time at various power levels is indicated in the table below:

Power level	1	2	3	4	5	6	7	8	9
Default working timer(hour)	8	8	8	4	4	4	2	2	2

When the pan is removed, the induction cooktop can halt heating immediately, and the cooktop will switch off automatically after 2 minutes.



Persons with a cardiac pacemaker should consult their doctor before using this appliance.

**Using The Timer**

You can use the timer in two different ways:

- You can use it as a minute minder. In this case, the timer will not turn any cooking zone off when the set time is up.
- You can set it to turn one or more than one cooking zone off after the set time is up.
- You can set the timer for up to 99 minutes.

**Using the timer as a minute minder**

1. Make sure the cooktop is turned on.

Note: you can use the minute minder even if you're not selecting any cooking zones.





2. Touch the timer control, the minder indicator will start flashing and 30 will show in the timer display.



IH30BFH



IH77BFH

3. Adjust the timer setting by touch the — or + controls.



IH30BFH



IH77BFH

Hint: Touch the — or + control of the timer once to decrease or increase by 1 minute.

Touch and hold the — or + control of the timer to decrease or increase by 10 minutes.

If the setting time exceeds 99 minutes, the timer will automatically return to 0 minute.

4. Touch the timer control, touch the — to decrease the time, and the — — will show in the minute display.



IH30BFH



IH77BFH

5. When the time is set, it will begin to count down immediately. The display will show the remaining time and the timer indicator will flash for 5 seconds.



6. Buzzer will beep for 30 seconds and the timer indicator shows — — when the set time finished.



### Setting the timer to turn one cooking zone off

1. Touch the heating zone selection control that you want to set the timer for. (e.g. zone 1#)



**17**

2. Touch the timer control, the minder indicator will start to flash in the timer display, and 30 will show in the timer display.



IH30BFH

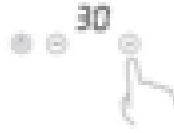

IH77BFH

3. Adjust the timer setting by touch the — or + controls.



IH30BFH



IH77BFH

Hint: Touch the — or + control of the timer once to decrease or increase by 1 minute.

Touch and hold the — or + control of the timer to decrease or increase by 10 minutes.

If the setting time exceeds 99 minutes, the timer will automatically return to 0 minute.

4. Touch the timer control, touch the — to decrease the time, and the — — will show in the minute display.



IH30BFH

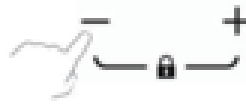

IH77BFH

NOTE: The red dot next to the power level indicator will illuminate indicating that zone is selected.

5. When cooking timer expires, the corresponding cooking zone will be automatically switched off and show H.



**Setting the timer to turn more than one cooking zone off**

1. If use this function to more than one heating zone, the timer indicator will show the shortest time.(e.g. zone 2# setting time of 3 minutes, zone 3# setting time of 6 minutes, the timer indicator shows 3.)



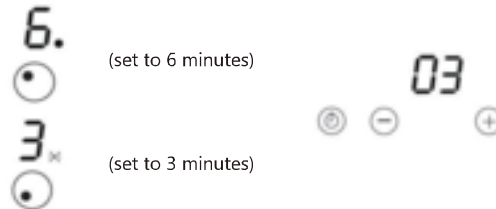

2. When cooking timer expires, the corresponding heating zone will be automatically switched off and show **H**.

NOTE: If you want to change the time after the timer is set, you have to start from step 1.



## Cooking Instructions

 Pay attention when frying, because oil and fat heat up very quickly, particularly if using the power boost function. At extremely elevated temperatures oil and fat spontaneously burst into flames, and this poses a serious fire risk.

## Advice on cooking

- When the food reaches boiling point, reduce the temperature.
- Use a cover can reduce cooking time and save energy by retaining heat.
- Reduce the quantity of liquid or fat can reduce cooking time.
- Begin cooking at a high temperature and reduce the setting when the food is re-heated.

## Gentle heat, cooking rice

- Simmer below boiling point to about 85°C(185°F), when bubbles rise just occasionally to the surface of the cooking liquid. This is the key to delicious soups and tender stews, because the flavours develop without overcooking the food. You can also cook sauces based on eggs and thicken them below boiling point.
- Certain tasks, including cooking rice by the absorption method, may require a more elevated setting than the lowest to ensure the food is cooked properly in the time recommended.

## Searing steaks

To cook juicy, flavourful steaks:

1. Place the meat at room temperature for about 20 minutes before cooking.
2. Heat a frying pan with a thick bottom.
3. Coat the two sides of the steak with oil. Drizzle a little oil in the hot pan and then place the meat in.



**19**

4. Turn the steak once only during cooking. The exact cooking time depends on the thickness of the steak and the cooking you desire. The time may vary from 2 to 8 minutes each side. Touch the steak to judge how it is cooked. The firmer it is, the more "well done".
5. Leave the steak to rest on a pot for several minutes, let it to relax and become tender before serving.

**For stir-frying**

1. Select a wok with a flat bottom suitable for induction or a large pan.
2. Prepare all the ingredients and the materials. Frying the food should be rapid. If you should cook large quantities, cook the food in several small lots.
3. Preheat the pan briefly and add two tablespoons of oil.
4. Cook all the meat first, set aside and keep hot.
5. Stir-fry the vegetables. While they are hot but still crisp, turn the cooking zone to a lower setting, return the meat to the pan and add your sauce.
6. Mix the ingredients gently to ensure they are warm through.
7. Serve immediately.

**Heat Settings**

The parameters below are simply indications. The exact setting depends on several factors including your cooking pans and quantities cooked. Experiment with the induction cooktop to identify the settings that suit you best.

Heat setting	Suitability
1 - 2	<ul style="list-style-type: none"> <li>• Delicate warming for small amounts of food</li> <li>• Melting chocolate, butter, and foods that burn quickly</li> <li>• Gentle simmering</li> <li>• Slow warming</li> </ul>
3-4	<ul style="list-style-type: none"> <li>• Reheating</li> <li>• Rapid simmering</li> <li>• Cooking rice</li> </ul>
5-6	<ul style="list-style-type: none"> <li>• Pancakes</li> </ul>
7-8	<ul style="list-style-type: none"> <li>• Sauteing</li> <li>• Cooking pasta</li> </ul>
9	<ul style="list-style-type: none"> <li>• Stir-frying</li> <li>• Searing</li> <li>• Bringing soup to the boil</li> <li>• Boiling water</li> </ul>



## Maintenance And Cleaning

What?	How?	Important!
Every day stains on the glass (finger and other marks, spots left by the food or spillage to crystallised on the glass).	<ol style="list-style-type: none"> <li>1. Cut off the power to cooktop.</li> <li>2. Apply detergent to cooktop while glass is still hot but not burning.</li> <li>3. Rinse and wipe with clean cloth or paper towel.</li> <li>4. Switch on the cooktop.</li> </ol>	<ul style="list-style-type: none"> <li>• When the electric power is cut off, there is no "surface hot" display, but the cooking zone may still be hot! Be extremely careful.</li> <li>• Sponges and certain nylon scourers and abrasive cleaning agents may scratch the glass. Always read the label, to see if your detergent or scourer is suitable.</li> <li>• Never leave residues of detergent on the cooking surface, the glass may be stained.</li> </ul>
Spills and hot sugars on the glass.	<p>Wipe immediately with a slice of bread, a knife or a razor blade suited to glass induction cooktop, but beware of hot cooking zone surfaces:</p> <ol style="list-style-type: none"> <li>1. Cut off the power to cooktop.</li> <li>2. Hold the blade or utensil at an angle of 30° and scrape off the dirt or liquid on the cold surface of the cooktop.</li> <li>3. Clean the stains or spill with a paper or cloth towel.</li> <li>4. Follow steps 2 to 4 in "Every day stains on the glass" above.</li> </ol>	<ul style="list-style-type: none"> <li>• Remove spots left by the bottom, sugary food and spills as soon as possible. If you leave the glass to cool, these may be difficult to remove or even irreparably damage the glass surface.</li> <li>• Reducing the risk: when the safety cap is retracted, the scraping blade is a sharp razor blade. Use with extreme care and always store safely out of the reach of children.</li> </ul>
Spillage on the touch setting controls	<ol style="list-style-type: none"> <li>1. Cut off the power to cooktop.</li> <li>2. Mop up the spill.</li> <li>3. Wipe the surface of touch setting controls with a cloth or clean, damp sponge.</li> <li>4. Wipe the zone completely dry with a paper towel.</li> <li>5. Switch on cooktop.</li> </ol>	<ul style="list-style-type: none"> <li>• The cooktop may emit a beep and turn off, and the control keys may not work, if there is liquid on them. Be sure to wipe the surface of the touch setting controls before switching on cooktop.</li> </ul>



**21**

**Hints And Tips**

<b>Problem</b>	<b>Possible reasons</b>	<b>What to do</b>
Induction cooktop cannot be switched on.	No electric power supply.	Ensure induction cooktop is connected to the power and it is switched on. Check whether there is a power cut in your building or region. If the problem persists after checking, call a qualified technician.
The touch setting controls do not respond.	Setting controls are locked.	Unlock setting controls. See the section "Using Your Induction Cooktop" for instructions.
Touch setting controls are difficult to use.	There may be a thin film of water on the setting controls, or you might have used the tip of your finger when touching them.	Ensure surface of the touch setting controls is dry and use the seat of the finger to touch them.
Glass is scratched.	Cooking pan has rough edges.	Use cooking pans with flat, smooth bases. See "Choosing The Right Cookware".
	Scourer unsuitable or abrasive or cleaning products used.	See "Maintenance And Cleaning".
Certain pots make crackling or clicking noises.	This may be caused by the structure of your cooking utensils(layers of various metals vibrate differently).	This is normal for cooking utensils and does not indicate a fault.
Induction cooktop makes a faint humming noise when used at high temperature.	This is caused by induction cooking technology.	This is normal, but the noise should lessen or disappear completely when you reduce the heat setting.
Fan noise coming from the induction cooktop.	A cooling fan is integrated in your induction cooktop to prevent overheating. It may continue to rotate, even after switching off the induction cooktop.	This is normal and requires no action. Do not unplug induction cooktop from the mains while fan is rotating.
Pots do not heat and screen display.	Induction cooktop may not detect the pot, because it is not suited to induction cooking.	Use cooking pots for induction cooking. See the section "Choosing The Right Cookware".
	Induction cooktop may not detect the pot, because it is too small for the cooking zone or not properly centred.	Centre the pan and ensure its base corresponds to the size of the cooking zone.
The induction cooktop or a cooking zone switches off unexpectedly, a beep sounds and an error code shows(generally alternately with one or two figures displayed in cooking timer).	Technical fault.	Please note the error code in letters and numbers, unplug induction cooktop from the mains and contact a qualified technician.



## Failure Display And Inspection

If an abnormality comes up, the induction cooktop will enter the protective state automatically and display corresponding protective codes:

Problem	Possible reasons	What to do
F3/F4	Temperature sensor of the induction coil failure.	Please contact the supplier.
F9/FA	Temperature sensor of the IGBT failure.	Please contact the supplier.
E1/E2	Abnormal supply voltage.	Check if the voltage is normal. Switch on once electric power is normal.
E3	Elevated temperature of the temperature sensor for an inductor fault.	Please contact the supplier.
E5	Elevated temperature of the temperature sensor for an IGBT module.	Please restart after the cooktop cools down.

The above concerns assessment and inspection of common faults.

Do not dismantle the appliance yourself, to prevent dangers and damage to the induction cooktop.

## Technical Specifications

Model	IH30BFH	IH77BFH
Cooking Zones	2 Zones	5 Zones
Supply Voltage	220-240V~	220-240V~
Frequency	50-60Hz	50-60Hz
Rating Power	3000-3800W	6800-7400W
Product Size L×W×H	11 <sup>1</sup> / <sub>2</sub> * 20 <sup>1</sup> / <sub>2</sub> * 2 <sup>1</sup> / <sub>2</sub> in	30 <sup>1</sup> / <sub>3</sub> * 20 <sup>1</sup> / <sub>2</sub> * 2 <sup>1</sup> / <sub>3</sub> in
Built-in Dimension A×B	10 <sup>3</sup> / <sub>5</sub> * 19 <sup>4</sup> / <sub>5</sub> in	29 <sup>1</sup> / <sub>5</sub> * 19 <sup>1</sup> / <sub>3</sub> in

The weight and dimensions are approximate. We are continually improving our products, and we may modify the specifications, designs and models without notice.



**23**

## Installation Choice Of Installation Material

Arrange the work surface in line with the dimensions indicated in the drawing. For purposes of installation and use a minimum of 2 in should be kept round the hole.

Ensure thickness of work surface is less than 1<sup>1</sup>/<sub>5</sub> in. Please select materials of work surface resistant to heat, to prevent deformation caused by heat generated by the hot cooktop, as indicated below:

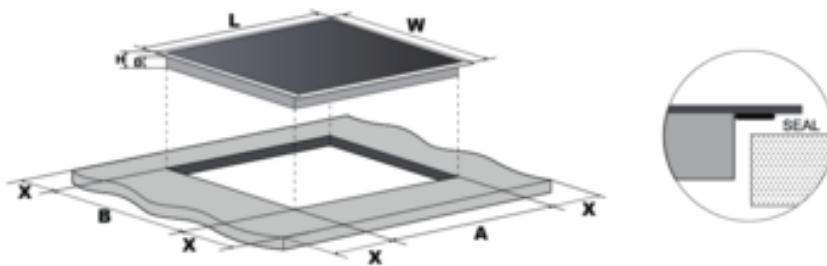

Model	L	W	H	D	A	B	X
IH30BFH	11 <sup>1</sup> / <sub>2</sub> in	20 <sup>1</sup> / <sub>2</sub> in	2 <sup>1</sup> / <sub>2</sub> in	2 <sup>1</sup> / <sub>3</sub> in	10 <sup>3</sup> / <sub>5</sub> in	19 <sup>4</sup> / <sub>5</sub> in	2 in mini
IH77BFH	30 <sup>1</sup> / <sub>3</sub> in	20 <sup>1</sup> / <sub>2</sub> in	2 <sup>1</sup> / <sub>3</sub> in	2 in	29 <sup>1</sup> / <sub>5</sub> in	19 <sup>1</sup> / <sub>3</sub> in	2 in mini

Always ensure the induction cooktop is well ventilated and air inlet and outlet are not blocked. Ensure induction cooktop is in good condition, as indicated above.

Remark: the safety distance between cooktop and furniture above it should be at least 30 in.

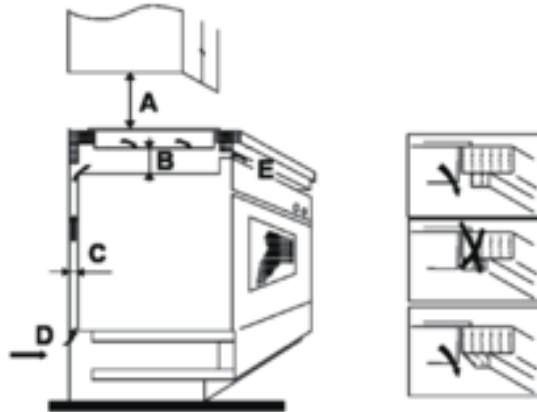

A	B	C	D	E
30 in	2 in mini	<sup>4</sup> / <sub>5</sub> in mini	Air intake	Air exit <sup>1</sup> / <sub>5</sub> in





## Before Locating The Fixing Brackets

1. The unit should be placed on a stable, smooth surface(use the packaging). Do not apply force onto the controls protruding from the cooktop.
2. Fix the cooktop on the work surface by screw four brackets on the bottom of the cooktop(see picture) after installation.  
Adjust the bracket position to suit for different work surface's thickness.

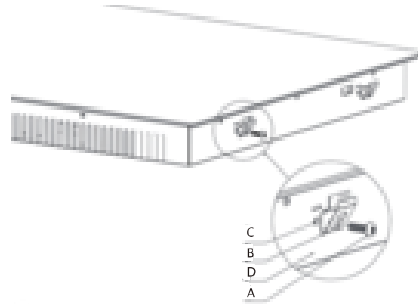

A	B	C	D
screw	bracket	screw hole	bottom/housing

3. Insert the appliance into the installation opening.

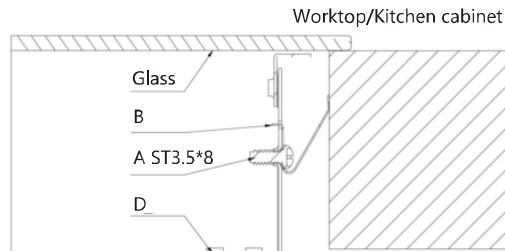

## Cautions

1. The induction cooktop must be installed by qualified personnel or technicians.
2. The induction cooktop shall not be mounted to directly above a dishwasher, fridge, freezer, washing machine or clothes dryer, as the humidity may damage the cooktop electronic.
3. The induction cooktop shall be installed such that better heat radiation can be ensured to enhance its reliability.
4. The wall and induced heating zone above the worktop shall withstand heat.
5. To avoid any damage, the sandwich layer and adhesive must be resistant to heat.
6. A steam cleaner is not to be used.
7. This induction can be connected only to a supply with system impedance no more than 0.427 ohm. In case necessary, please consult your supply authority for system impedance information.



**25**

## Connecting The Cooktop To The Mains Power Supply

The power supply should be connected in compliance with the relevant standard, or a single-pole circuit breaker. The method of connection is shown below.

### IH30BFH

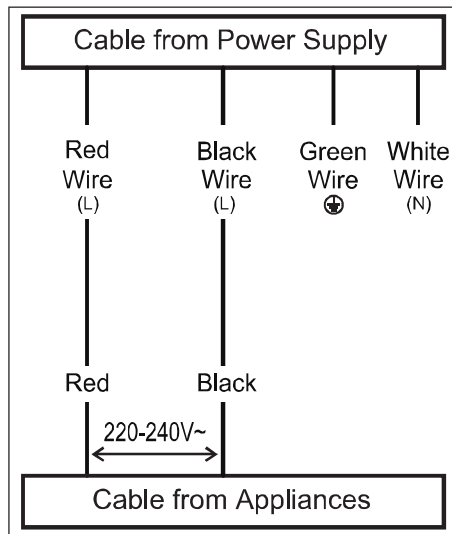

### IH77BFH

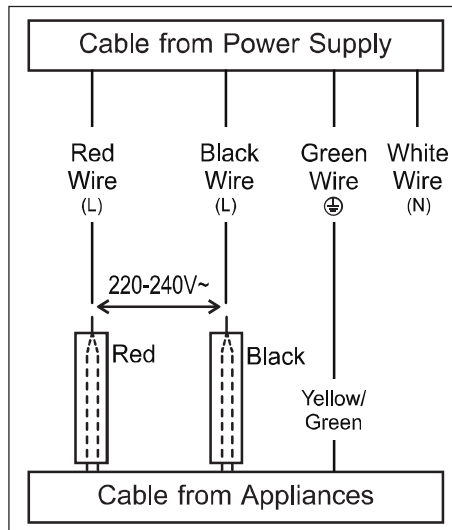

1. If the cable is damaged or needs replacing, this should be done by a technician using the proper tools, so as to avoid any accidents.
2. If the appliance is being connected directly to the mains supply, an omnipolar circuit breaker must be installed with a minimum gap of 0.12 in between the contacts.
3. The installer must ensure that the correct electrical connection has been made and that it complies with safety regulations.
4. The cable must not be bent or compressed.
5. The cable must be checked regularly and only replaced by a properly qualified person.

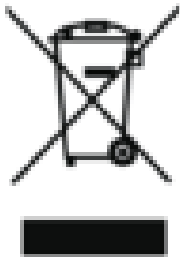
 <p><b>DISPOSAL: Do not dispose this product as unsorted municipal waste. Collection of such waste separately for special treatment is necessary.</b></p>	<p>This appliance is labeled in compliance with European directive 2002/96/EC for Waste Electrical and Electronic Equipment(WEEE). By ensuring that this appliance is disposed of correctly, you will help prevent any possible damage to the environment and to human health, which might otherwise be caused if it were disposed of in the wrong way.</p> <p>The symbol on the product indicates that it may not be treated as normal household waste. It should be taken to a collection point for the recycling of electrical and electronic goods.</p> <p>This appliance requires specialist waste disposal. For further information regarding the treatment, recover and recycling of this product please contact your local council, your household waste disposal service, or the shop where you purchased it.</p> <p>For more detailed information about treatment, recovery and recycling of this product, please contact your local city office, your household waste disposal service or the shop where you purchased the product.</p>
--	--





(844) 538-7890 [www.gaslandchef.com](http://www.gaslandchef.com) [support@gaslandchef.com](mailto:support@gaslandchef.com)

