

# INSTALLATION GUIDE

EFFECTIVE JANUARY 2014





Known for its outstanding performance qualities, vinyl siding is increasingly the material of choice for homeowners, remodeling contractors, architects, and builders. Compared to other siding products, vinyl is attractive, durable, easy to maintain, and cost-effective. Siding is available in a variety of textures, ranging from matte surfaces to deeply embossed wood grain surfaces, which simulate wood clapboard siding.

For best results, it is recommended that vinyl siding meet the requirements of the Vinyl Siding Institute Sponsored Certification Program. See [www.vinyl-siding.org](http://www.vinyl-siding.org) for a current list of certified products.

their own legal and technical advisors, building material suppliers, and other appropriate sources (including but not limited to product or package labels, technical bulletins or sales literature) that contain information about known and reasonably foreseeable health and safety risks of their proprietary products and processes. As the manufacturer of the vinyl siding we do not assume any responsibility for the users' compliance with applicable laws and regulations, nor for any persons relying on the information contained in this guide.



This manual sets forth the basic guidelines for vinyl siding installation. The instructions herein are based, in part, on ASTM Specification D4756, the standard method for installation of vinyl siding and soffit. Updated information has been added as necessary. Additionally, it is recommended that installers review applicable building codes for variations that may apply to specific products or geographic areas.

The method of applying vinyl siding and soffit is essentially the same for new construction and residing. However, where required, special instructions for new construction and residing are included, as well as recommendations for historic restoration. In all applications, care should be exercised to properly prepare the structure. See the Basic Installation Rules and additional details throughout this document for proper installation techniques.

This publication is not intended to provide specific advice, legal or otherwise, on particular products or processes. Readers should consult with





**Foreword/Inside cover** ..... 1

**Important Notes**

- Helpful Suggestions ..... 3
- Fire Safety Information ..... 3
- Storage and Transportation ..... 3

**Basic Installation Rules** ..... 4

**Cleanup**

- Helpful hints ..... 5
- Stains & Cleaners ..... 6

**Terms to Know** ..... 7-8

**Basic Installation Tools & Equipment**

- Accessories ..... 9
- Tools ..... 10

**How to Measure**

- Step by Step* ..... 11
- Estimating Required Materials ..... 11

**Estimating Worksheet** ..... 12

**Fastener Choices**

- Nails, Screw Fasteners and Staples ..... 13

**Fastening Procedures** ..... 14

**Cutting the Siding** ..... 15

**Preparing the Walls**

- New Construction ..... 16
- Residing Existing Structures ..... 17
- Over Masonry Sub-Surface ..... 18

**Accessories Installation**

- Starter Strip ..... 19-20
- Outside and Inside Corner Posts ..... 21-22
- Decorative 3-Piece Corner System ..... 23
- Window Flashing ..... 24
- Window Trim ..... 24
- Window and Door Surrounds ..... 25-26
- Gable Trim ..... 27
- J-Channel above Roof Lines ..... 28

**Horizontal Siding Installation**

- Installing Panels ..... 29
- Fitting Siding around Fixtures ..... 30
- Fitting Under Windows ..... 31
- Finishing at the Top ..... 32
- Gable Ends ..... 33
- Eave Treatment ..... 33

**Transition from Horizontal to Vertical** ..... 34

**Vertical Siding Installation (including Board & Batten)**

- Preparation ..... 35
- Siding Accessories ..... 36

**Soffit Installation**

- Preparation ..... 37
- Over Open Eaves ..... 37-38
- Enclosed Eaves ..... 39

**Fascia Installation**

- Vinyl Fascia ..... 40
- Aluminum Fascia ..... 41

**Porch Ceilings**

- New Construction Projects ..... 42
- Residing Projects ..... 42

**Replacing Damaged Panels**

- ..... 43

**Shutter Installation**

- ..... 44

**Shingle & Hand-Split Installation**

- Guidelines ..... 45
- Starter Strip ..... 46
- Corner Post ..... 47
- Shingle ..... 48

**Round Cut Installation**

- Guidelines ..... 49
- Steps & Tips ..... 50-54

**Insulated Siding** ..... 55

**Historic Restoration** ..... 61

**Special Techniques** ..... 62-64

**Notes** ..... 65

The manufacturer has provided these suggested instructions as installation guidelines. The manufacturer, however, neither installs the panels nor has any control over the installation. It is the responsibility of the contractor and/or the installer to ensure panels are installed in accordance with these instructions and any applicable building codes. The manufacturer assumes no liability for either improper installation or personal injury resulting from improper use or installation.

### ***Fire Safety Information***

Vinyl building materials require little maintenance for many years. Nevertheless, common sense dictates that builders and suppliers of vinyl products store, handle, and install vinyl materials in a manner that avoids damage to the product and/or the structure. Owners and installers should take a few simple steps to protect vinyl building materials from fire.

#### ***To Home and Building Owners:***

Vinyl siding is made from organic materials and will melt or burn when exposed to a significant source of flame or heat. Building owners, occupants, and outside maintenance personnel should always take normal precautions to keep sources of fire, such as grills, and combustible materials, such as dry leaves, mulch and trash, away from vinyl siding.

#### ***To the Building Trades, Specifiers, Professionals, and to Do-It Yourself Installers:***

When vinyl siding is exposed to significant heat or flame, the vinyl will soften, sag, melt, or burn, and may thereby expose materials underneath. Care must be exercised when selecting underlayment materials because many underlayment materials are made from organic materials that are combustible.

It is important to ascertain the fire properties of underlayment materials prior to installation. All building materials should be installed in accordance with local, state, and federal building code and fire regulations.

### ***Storage and Transportation***

When transporting vinyl siding and accessories to the job site, make certain to keep the cartons flat and supported along their entire length. At the job site, take the following precautions when storing panels:

- Store the cartons on a flat surface and support the entire length of the cartons.
- Keep the cartons dry.
- Store the cartons away from areas where falling objects or other construction activity may cause damage.
- Do not store the cartons in stacks more than 12 boxes high.
- Do not store the cartons in any locations where temperatures may exceed 130° F (e.g., on blacktop pavement or under tarps or plastic wraps without air circulation).

### ***Residing over Asbestos Siding***

Asbestos siding is a regulated material and the appropriate environmental agency should be contacted before residing over this product begins.



The manufacturer has provided these suggested instructions as installation guidelines. The manufacturer, however, neither installs the panels nor has any control over the installation. It is the responsibility of the contractor and/or the installer to ensure panels are installed in accordance with these instructions and any applicable building codes. The manufacturer assumes no liability for either improper installation or personal injury resulting from improper use or installation.

1. Installed panels must move freely from side to side.
2. Do not stretch horizontal siding panels upward when applying; instead, push upward on the bottom of the panel you are installing, until the locks fully engage. Nail in place. Panels should hang without strain after nailing. Stretching the panel upward pulls the natural radius out of the panel and increases the friction of the locks.
3. Always nail in the center of the slot. **WARNING: Do not nail at the end of a slot!** Doing so will cause the siding panel to be permanently damaged. If you must nail near the end of a slot to hit a stud, etc., extend the length of the slot with a nail slot punch tool.
4. Do not nail tightly. Allow a minimum of 1/16" between the back of the nail head or staple crown and the nailing strip. Nails or staples should be placed approximately 12" to 16" apart. Drive nails straight and level to prevent distortion and buckling of the panel.
5. Leave a minimum of 1/4" clearance at all openings and stops to allow for normal expansion and contraction. When installing in temperatures below 40° F, increase minimum clearance to 3/8".
6. Do not caulk the panels where they meet the receiver of inside corners, outside corners, or J-Channel Trim. Do not caulk the overlap joints.
7. Do not face-nail or staple through siding. Vinyl siding expands and contracts with outside temperature changes. Face-nailing can result in permanent ripples in the siding.
8. Panels should be overlapped approximately 1 1/4". Fasten panels approximately 8" or more from the overlap seam for best lap appearance.
9. Avoid the use of unstable or uneven underlayment. Keep in mind that siding can only be as straight and stable as what lies under it. See Section "Preparing the Walls" for more information.
10. When installing shutters, cable mounts, etc., make sure screw hole in the siding is 1/4" larger than the attachment screw diameter. (Example: an 1/8" screw requires a 3/8" hole in the siding.) This will allow the panel to still expand and/or contract.
11. Never attach fixtures directly to panels. When attaching fixtures, first drill a hole in the siding 1/4" larger than the diameter of the fasteners, allowing for expansion and contraction. Note: Fasteners for fixtures must penetrate the solid substrate.



The beauty of vinyl siding is maintained with little effort. Although vinyl siding will get dirty, like anything exposed to the atmosphere, a heavy rain will do wonders in cleaning it. Or, it's possible to wash it down with a garden hose. If neither rain nor hosing does a satisfactory job, follow these simple instructions:



1. Use an ordinary, long-handled car washing brush. This brush has soft bristles, and the handle fastens onto the end of the hose. It allows the siding to be washed just like a car. Avoid using stiff bristle brushes or abrasive cleaners, which may change the gloss of the cleaned area and cause the siding to look splotchy.
2. When washing down your entire house, start at the bottom and work up to the top in order to prevent streaking. Rinse Cleaning Solution with water before it dries. If your house has brick facing, cover the brick so that it is not affected by the runoff.
3. Follow the precautionary labeling instructions on the cleaning agent container. Protect shrubs from direct contact with cleaning agents.
4. To remove soot and grime found in industrial areas, wipe down the siding with a solution made up of the following:
  - 1/3 cup powdered detergent [(e.g. Fab®, Tide®, or equivalent powder detergent)]\*
  - 2/3 cup powdered household cleaner [(e.g., Soilax®, Spic & Span®, or equivalent)]\*
  - 1 gallon water
5. If mold and mildew are a problem, add one quart of liquid laundry bleach to the cleaning solution mentioned above.
6. For stubborn stains, use the chart on the right. (page 6)

• Cleaning materials are listed in alphabetical order. The manufacturer does not endorse proprietary products or processes and makes no warranties for the products referenced herein. Reference to proprietary names is for illustrative purposes only and is not intended to imply that there are not equally effective alternatives.



**STAIN***Bubble Gum**Crayon**DAP [Oil-based caulk]**Felt-Tip Pen**Grass**Lipstick**Lithium Grease**Motor Oil**Paint**Pencil**Rust**Tar**Topsoil***CLEANERS\***

Fantastik<sup>®</sup>, Murphy's Oil Soap<sup>®</sup>,  
or solution of vinegar [30 percent] and  
water [70 percent]

Lestoil<sup>®</sup>Fantastik<sup>®</sup>Fantastik<sup>®</sup> or water-based cleaners

Fantastik<sup>®</sup>, Lysol<sup>®</sup>,  
Murphy's Oil Soap<sup>®</sup>, or Windex<sup>®</sup>

Fantastik<sup>®</sup>, or Murphy's Oil Soap<sup>®</sup>

Fantastik<sup>®</sup>, Lysol<sup>®</sup>,  
Murphy's Oil Soap<sup>®</sup>, or Windex<sup>®</sup>

Fantastik<sup>®</sup>, Lysol<sup>®</sup>,  
Murphy's Oil Soap<sup>®</sup>, or Windex<sup>®</sup>

Brillo<sup>®</sup> Pad or Soft Scrub<sup>®</sup>Soft Scrub<sup>®</sup>

Fantastik<sup>®</sup>, Murphy's Oil Soap<sup>®</sup>,  
or Windex<sup>®</sup>

Soft Scrub<sup>®</sup>

Fantastik<sup>®</sup>, Lysol<sup>®</sup>,  
or Murphy's Oil Soap<sup>®</sup>

**CAUTION:** Do not use or mix sodium hypochlorite with other household chemicals or products containing ammonia. To do so will release hazardous gasses.

\*Cleaning materials are listed in alphabetical order. The manufacturer does not endorse proprietary products or processes and makes no warranties for the products referenced herein. Reference to proprietary names is for illustrative purposes only and is not intended to imply that there are not equally effective alternatives.

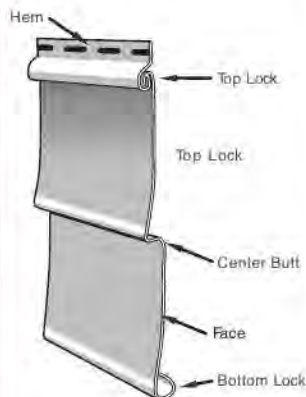

**Backerboard/Underlayment**—a flat material used on the face of the house, between the studs and the siding, to provide a flat surface for the siding.

**Bottom Lock**—the bottom edge of a siding or a soffit panel, or accessory piece, opposite the nailing slots, which locks onto the preceding panel.

**Channel**—the area of the accessory trim or corner post where siding or soffit panel is inserted. Channel also refers to the trim itself, and are named for the letters of the alphabet they resemble (e.g., J-Channel, F-Channel, etc.).

**Course**—a row of panels, one panel wide, running the length of the house. Or, in the case of vertical siding, from top to bottom.

**Drip Cap/Head Flashing**—an accessory installed to channel water away from siding panels and sub-wall. Drip cap is often used on the tops of windows/doors and when transitioning from horizontal to vertical siding.

**Face**—refers to the side of a siding or soffit panel that is exposed once the panel has been installed.

**Fascia Board**—(sometimes referenced as a sub fascia) board attached to the ends of the rafters between the roofing material and the soffit overhang.

**Fascia Cap**—the covering installed on the fascia board.

**Flashing**—a thin, flat material, usually aluminum, positioned under or behind J-Channels, Corner Posts, Windows, etc., to keep draining water from penetrating the home.

**Furring/Furring Strip**—a wooden framing material, usually 1" x 3", used to provide an even nailing base. To "fur" a surface means to apply these strips.

**H-Mold (Double Channel Lineal)**—a siding accessory that joins the ends of vertical siding and soffit panels.

**Housewrap**—weather-resistant, breathable film used to cover wood underlayment prior to the installation of siding.

**Lap**—to overlap the ends of two siding panels or accessory pieces to join the panels/pieces and allow for expansion and contraction of the vinyl product.

**Lug/Crimp**—the raised "ears" or tabs on a siding panel, created by a snaplock punch, which can be used to lock a siding panel into undersill trim when the nailing hem has been removed.

**Miter**—to make a diagonal cut, beveled to a specific angle (usually 45°).

**Nailing Hem (or Flange)**—the section of siding or accessories where the nailing slots are located.

**Plumb**—a position or measurement that is truly and exactly vertical, 90° from a level surface.

**Scoring**—running a utility knife blade across a soffit or siding panel face without cutting all the way through the panel. This weakens the vinyl surface in a specific area and allows the panel to be bent and broken off cleanly.

**Soffit**—material used to enclose the horizontal underside of an eave, cornice or overhang.

**Starter Strip**—an accessory applied directly to the surface of the building and used to secure the first course of siding to the home.

**Weep Holes**—openings cut into the siding panel or accessories during the manufacturing process to allow for water runoff.

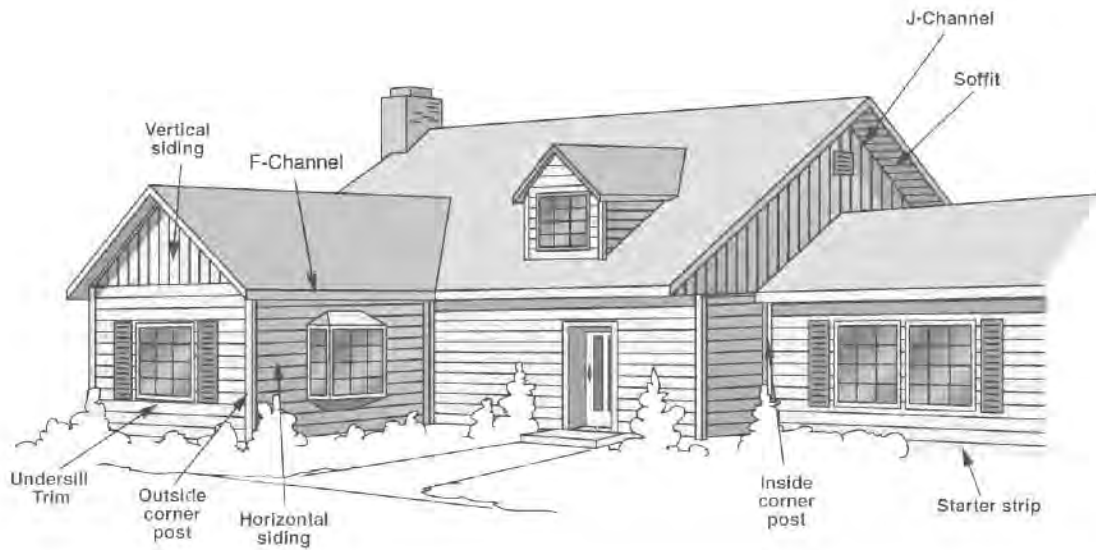

### Outside and Inside Corner Post

Corner posts are used to provide a finished edge at an inside or outside corner. The siding from adjoining walls fits neatly into the inside or outside corner post channels.

*NOTE: We produce various sizes of J-Channels and Corner Posts. Remember to order accessories of the proper size to accommodate the siding panels.*

### Trim and Molding

A complete line of accessories is used to give every installation a professional, weather-resistant appearance. Common accessories include Corner Posts, Starter Strips, F-Channels, Undersill Trim, and J-Channels (left). Each of these accessories will be addressed in more detail throughout this manual.

**Inside Corner Post**



**Outside Corner Post**



**Undersill Trim**



**J-channel**



**Starter Strip**



**F-channel**





Fig. 1

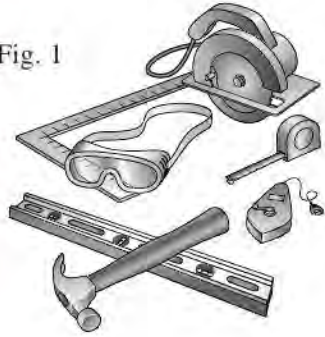

### **Hand Tools**

Common hand tools, such as a hammer, saw, square, chalkline, level, and tape measure are needed for proper installation (Fig. 1). Safety glasses are recommended for eye protection. Other basic tools include:

### **Power Saw**

A bench or radial-arm power saw can speed the cutting of the siding. A finetooth blade (12 to 16 teeth per inch) should be used with the blade installed in the reverse direction. Some applicators prefer a hand-held power saw and a field-built cutting table. In extremely cold weather, move the saw through the material slowly to prevent chipping or cracking (Fig. 2).

Fig. 2



**NOTE:** A saw blade set up in reverse direction should be used only for cutting vinyl. **DO NOT** attempt to use it on other materials such as wood, plywood, etc.

Fig. 3



### **Utility Knife**

Vinyl is easy to cut, trim and score with a utility knife or scoring tool (Fig. 3).

### ***Tin Snips***

Good quality tin snips and compound aviation-type snips will speed the cutting and shaping of the vinyl (Fig. 4).

### ***Snaplock Punch***

A snaplock punch is used to punch lugs in the cut edges of siding to be used for the top or finishing course at the top of a wall, or underneath a window (Fig. 5).

### ***Nail Hole Punch***

Occasionally, it may be necessary to elongate a nail slot. The hole is elongated to allow for expansion and contraction (Fig. 6).

### ***Unlocking Tool (Zip-Lock Tool)***

Remove or replace a siding panel with the unlocking tool. Insert the curved end of the tool under the end of the panel and hook onto the back lip of the buttlock. To disengage the lock, pull down and slide the tool along the length of the panel. Use the same procedure to relock a panel (Fig. 7).



Fig. 4



Fig. 5



Fig. 6



Fig. 7

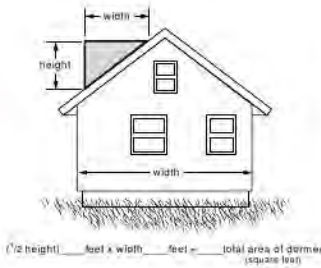
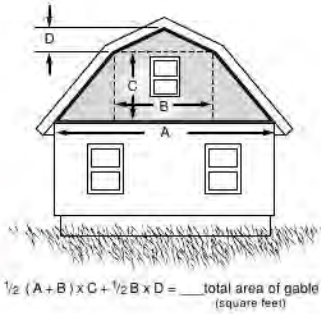
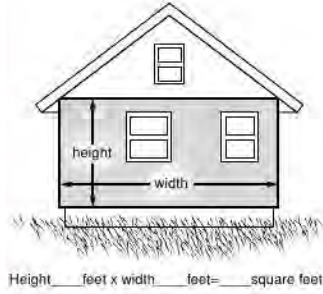
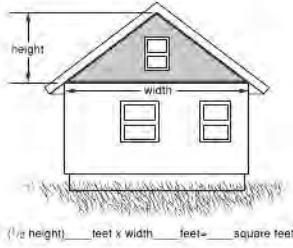

1. All houses can be broken down into shapes of rectangles, triangles or a combination of both.

2. The area to be sided can be determined by measuring the height and width of the house, including windows (below).

3. Total all of the measurements for the areas to be sided. Windows and doors are not usually deducted. Including them will provide an allowance factor for waste. If the windows and doors are extremely large (such as garage or sliding glass doors), some deductions can be made. Dormers and gables are prone to material waste due to cutting and fitting.

4. To estimate the amount of starter strip required, measure the linear feet around the entire base of the house. When measuring linear footage, add a factor of 10 percent to allow for waste.



Use the following worksheet to estimate the required materials:

<b>Siding Walls</b>		___ square feet	
Gable ends		___ square feet	
Upper gambrel walls		___ square feet	
Total wall surface area		___ square feet	
Large areas not covered		___ square feet [A]	
[garage doors/sliding doors]	<u>x0.50=</u>		
Uncovered area		___ square feet [B]	
<u>Subtract B from A for</u>			
Total net surface area		___ square feet	
<b>Soffit</b>		___ square feet	
<b>Porch Ceiling</b>		___ square feet	
<b>Accessories</b>	Starter Strip	___ linear feet	
	Utility trim	___ linear feet	
<b>Receiving channel</b>	J-Channel	___ linear feet	
	Flexible J-Channel	___ linear feet	
	F-trim	___ linear feet	
	3 1/2" and 5" Window & Door Surround	___ linear feet	
<b>Outside corners</b>	Outside corner post	___ linear feet	
	Fluted corner trim	___ linear feet	
<b>Inside corners</b>	Inside corner post	___ linear feet	
	J-Channel	___ linear feet	
<b>Other</b>	Soffit cove trim	___ linear feet	
	H-molding	___ linear feet	
	Light blocks	___ linear feet	
	Width of accessory recess opening:		
	[please circle one]    1/2"    5/8"    3/4"    1 1/8"		
<b>Nails</b>	Pounds required		
	Length [1 1/2" minimum]	___ pounds	
<b>Tools needed</b>	___ hammer	___ tin snips	___ chalkline
	___ utility knife	___ square	___ hacksaw
	___ nail hole punch	___ tape measure	___ level
	___ power saw	___ unlocking tool	
	___ snaplock punch	___ finetooth saw blade	

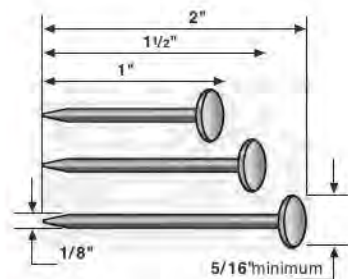
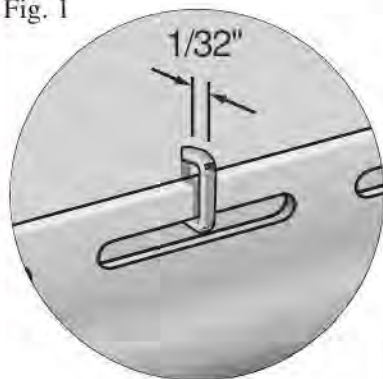

Fig. 1



Use aluminum, galvanized steel or other corrosion-resistant nails, staples or screws when installing vinyl siding. Aluminum trim pieces require aluminum or stainless steel fasteners.

### **Nails**

Nail heads should be 5/16" minimum in diameter. Shank should be 1/8" in diameter.

Minimum nail lengths are as follows:

- 1 1/2" for general use
- 2" for residing
- 1" to 1 1/2" for trim

### **Screw Fasteners**

Screw fasteners can be used if the screws do not restrict the normal expansion and contraction movement of the vinyl siding panel on the wall. Screws must be centered in the slot with a minimum 1/16" space between the screw head and the vinyl.

Screws should be:

- Size #8, truss head or pan head.
- Corrosion-resistant, self-tapping sheet metal type.

### **Staples**

If staples are being used instead of nails or screws, they must be:

- Not less than 16-gauge semi-flattened to an elliptical cross-section (Fig. 1).
- A minimum of 1" long.
- Wide enough in the crown to allow free movement of the siding.
- 1/16" clearance between staple crown and nailing hem of the siding panel.

Vinyl siding can expand and contract 1/2" or more over a 12' 6" length with changes in temperature. Whether using a nail, screw or staple to fasten the siding, the following basic rules must be followed:

### Step 1

Make sure the bottom lock of the panels are fully engaged along the entire length of the panel.

**WARNING:** Push the panel up fully but do not stretch the panel by pulling it from the top.

### Step 2

**Do not** drive the head of the fastener tightly against the siding nail hem. Leave a minimum of 1/16" (the thickness of a nickel) between the fastener head and the vinyl. Tight nailing, screwing, or stapling will cause the vinyl siding to buckle with changes in temperature (Fig.1). Nail head, screw head, or staple crown should not extend out more than 3/16" from the siding nailing hem. If the head or crown contacts the vinyl panel it may "pimple" or distort due to heat build-up.

### Step 3

After locking the panel, fasten about 1/3 of the way from each end. Finish fastening the panel. This method helps keep panels running straight.

### Step 4

*NOTE: Nail 8" or more away from the end of a panel that will be overlapped with another panel. This will help the overlap appearance.*

Center the fasteners in the slots to permit expansion and contraction of the siding (Fig. 2).

### Step 5

Drive fasteners straight and level to prevent distortion and buckling of the panel (Fig. 3).

### Step 6

Space the fasteners a maximum of 16" apart for horizontal siding panels, 12" apart for vertical siding panels, and 8" to 10" apart for the accessories.

### Step 7

Start fastening vertical siding and corner posts in the top of the upper-most slots to hold them in position. Place all other fasteners in the center of the slots (Fig. 4).

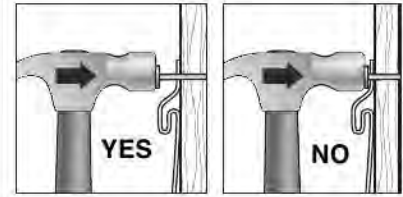

Fig. 1

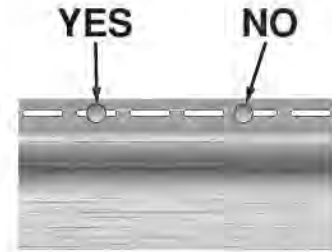

Fig. 2

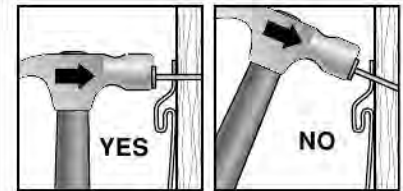

Fig. 3

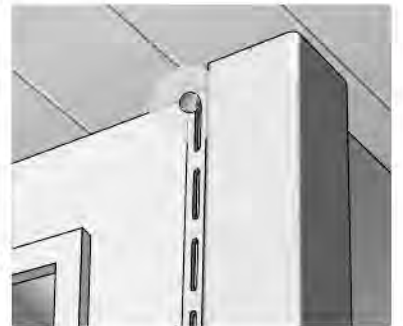

Fig. 4





Fig. 1

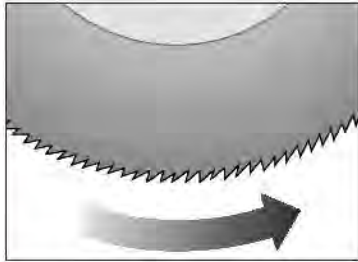

Fig. 2

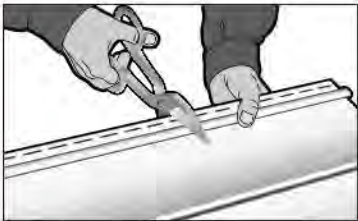

Fig. 3

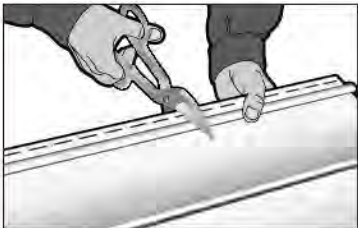

Fig. 4

When cutting vinyl siding, follow these guidelines:

### **Step 1**

Safety goggles are always recommended for all cutting and nailing operations. As on any construction job, use proper safety equipment and follow safe construction practices (Fig. 1).

### **Step 2**

With a circular saw, install the fine-toothed (plywood) blade backward on the saw for a smoother, cleaner cut. Cut slowly. Do not attempt to cut materials other than vinyl with a reversed direction saw blade (Fig. 2).

### **Step 3**

With a utility knife or scoring tool, score the vinyl face up with medium pressure and snap it in half. It is not necessary to cut all the way through the vinyl (Fig. 3).

### **Step 4**

With tin snips, avoid closing the blades completely at the end of a stroke for a neater, cleaner cut (Fig. 4).

**Sheathing/Backerboard**

Our vinyl siding should be applied over a sheathing that provides a smooth, flat, stable surface. Consult local building codes for sheathing requirements. Vinyl siding should never be applied directly to studs without sheathing. **We recommend that wood-based sheathings be protected utilizing moisture-resistant housewrap or building paper prior to the installation of the siding and accessories. Some building codes now require this protection.**

**Flashing**

Flashing, such as aluminum coil stock, should be applied around windows, doors, other openings, inside and outside corners, and the intersection of walls and roofing to prevent water infiltration.

**New Construction****Step 1**

Make sure all studs are straight and true to avoid bulges or dips in the finished wall. Correct any bowed studs at this time.

**Step 2**

Make sure all sheathing is properly fastened to the framing according to building code requirements and/or the sheathing manufacturer's recommendations.

*NOTE: Sheathing behind vinyl siding must be smooth, flat, stable and appropriate for use on the type of construction being erected. Increasing requirements in building codes, especially in the areas of fire and wind resistance, make the appropriate choice and fastening of wall sheathing an important area of consideration. Check local building codes for the allowable type and thickness of sheathing that can be utilized on the type of structure being sided.*

**Step 3**

Make sure subwall assembly is weathertight before applying siding. Vinyl siding and vinyl siding accessories alone do not constitute a waterproof installation. The combination of proper subwall preparation and siding installation result in the desired protection of the structure.

Wall sheathing should be weather-resistant, or covered with a weather-resistant barrier such as fanfold insulation, housewrap, or building paper. **Independent VSI studies indicate that the combination of a weather resistant barrier plus a housewrap result in improved weather performance of the vinyl siding.** Some building code jurisdictions are currently requiring this protection. A weather-resistant covering should be properly fastened according to the manufacturer's instructions, and be smooth and

even. Flashing and caulking should be added as needed in areas such as windows, doors, and other openings to control moisture and to protect the subwall assembly.

*WARNING: A smooth, flat, stable wall surface is necessary for the proper installation of vinyl siding. Waviness in the finished siding resulting from uneven or inadequate backerboard sheathing constitutes misapplication under the terms of the warranty.*

*TIP: Place the drywall in the house, on the floor of the room where it is going to be applied, prior to the installation of the siding when possible. This will help load the floor system and the floor band prior to applying siding. This can help reduce panel bulging in the floor band areas where compression and shrinkage typically occur.*



Fig. 1

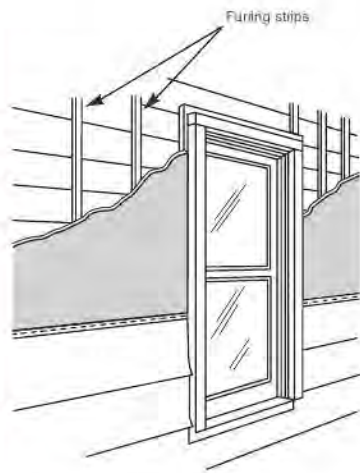

Fig. 2

## *Residing Existing Structures*

### *Step 1*

Nail down any loose boards on existing siding, and replace any rotten wood as needed. **DO NOT INSTALL VINYL SIDING OVER ROTTEN WOOD.** (See Fig. 1)

### *Step 2*

Scrape off loose caulk and any other buildup that may interfere with the siding installation. Remove all items such as gutters, downspouts, and light fixtures as needed.

### *Step 3*

Install suitable sheathing, as needed, to provide a smooth, flat, and stable surface for the installation of the vinyl siding. See information previously given in this segment for additional instructions on subwall protection and flashing.

### *Step 4*

Install furring in areas needing straightening and leveling. Apply rigid sheathing to cover and level the furring strips. Do not apply vinyl siding directly to furring strips without sheathing, because the siding may conform around the furred areas causing an uneven appearance. (See Fig 2)

### *Step 5*

Window and door casings may need additional attention or preparation. Depending on vinyl siding moldings being used, a window/door casing generally needs to extend out from the finished subwall sufficiently, to allow a J-Channel or similar molding to butt to it. In some situations, building out the casings, or using special purpose moldings such as Window and Door Surround may be necessary.



## Over Masonry Sub-surface

1" x 3" wood strips are installed with masonry nails over the masonry area to be sided (Fig. 1). For increased decay resistance, use pressure treated furring strips.

### Step 1

For horizontal siding, strips should be installed vertically 12" to 16" on center. They should be installed completely around doors, windows and other openings, at all corners, and at the top and bottom of the area to be sided.

### Step 2

For vertical siding, furring is essentially the same as for horizontal siding. Strips should be nailed horizontally 12" to 16" centers.

*NOTE: Furring strips should be covered with insulated sheathing or the spaces between the furring strips should be filled in with insulated sheathing equal in thickness to the furring strips. This will provide an even wall surface for the siding and help avoid any wayiness.*

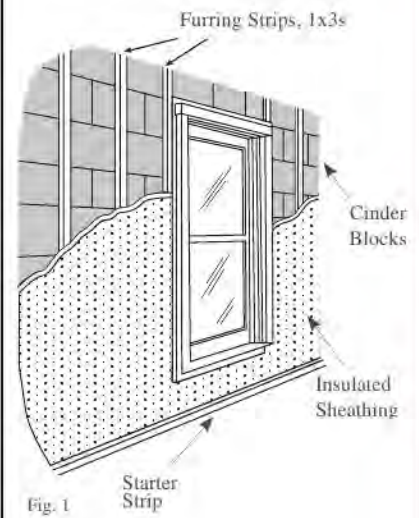

Fig. 1

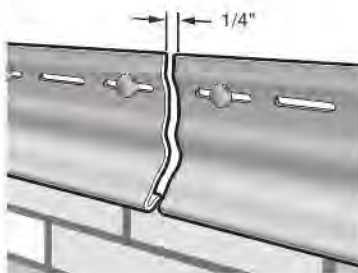

Fig. 1

Before the vinyl siding itself can be hung, a number of accessories must be installed first, including starter strips, corner posts, window flashing, trim and J-Channels.

### **Step 1**

In order for the vinyl siding to be installed properly in a level fashion, the starter strip at the bottom of the wall must be level.

### **Step 2**

Determine the lowest point of the wall that will be sided; from that point, measure up 1/4" less than the width of the starter strip and partially drive a nail at one corner.

### **Step 3**

Attach a chalkline: go to the next corner and pull the line taut.

### **Step 4**

Make sure the line is level by using a line level or a four-foot level.

### **Step 5**

Snap the chalkline and repeat the procedure around the entire house.

### **Step 6**

Using the chalkline as a guide, install the top edge of the starter strip along the bottom of the chalkline, nailing at 10" intervals. Allow space for accessories (corner posts, J-Channels, etc.)

### **Step 7**

Keep the ends of starter strips at least 1/4" apart to allow for expansion (Fig. 1).

### **Step 8**

Nail in the center of the starter strip nailing slots.

### **Step 9**

Starter strip fasteners should be driven just flush in the center of the slots to take out starter looseness, but should not be overdriven to where it indents the starter.

In most situations a typical starter strip is used to start the first course of siding. Special circumstances (panel application around decking, special roof lines and other unique atypical applications) may require other techniques to secure the first panel locking leg. This can be accomplished in several manners (as illustrated in Figures 1-3).

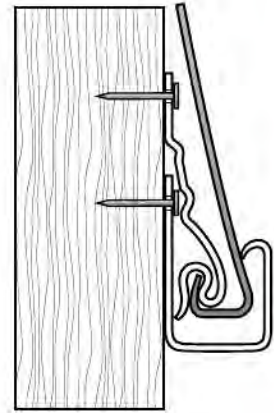

Fig. 1 Starter Strip Inside J-Channel

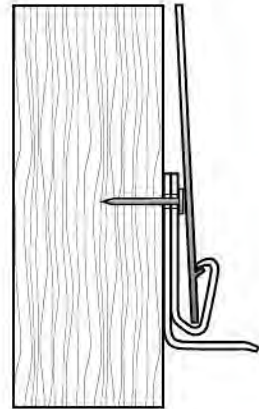

Fig. 2 Undersill with Snaplock and Flashing

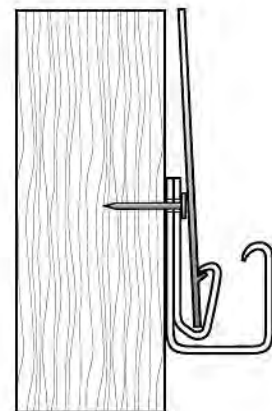

Fig. 3 J-Channel and Undersill Trim



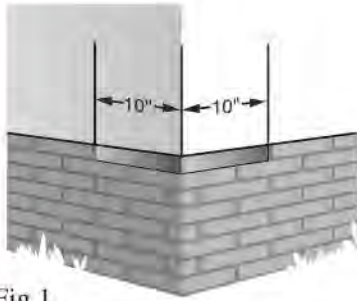

Fig. 1

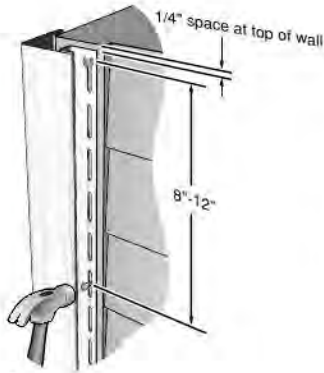

Fig. 2

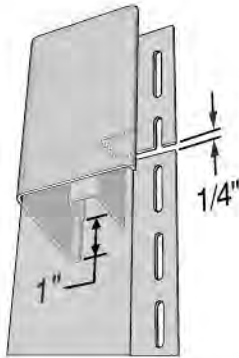

Fig. 3

### Step 1

A water-resistant material should be used to flash the inside and outside wall corners a minimum of 10" on each side before installation of the corner posts (Fig. 1).

### Step 2

Place the corner post in position, allowing a 1/4" gap between the top of the post and the eave or soffit (Fig. 2).

*NOTE: If vinyl or aluminum soffit will be installed, either install prior to corner post installation or allow for soffit and accessory thickness when positioning the height of the corner.*

Position a nail at the top of the upper slot on both sides of the corner post, leaving a 1/16" gap between the nail heads and the corner post nailing hem. The corner post hangs from these nails. The balance of the nailing should be in the center of the slot, 8" to 12" apart, again leaving 1/16" between the nail head and the corner post. This allows for the expansion and contraction to

occur at the bottom. The corner post should extend 1/4" below the starter strip. Make sure the posts are vertically straight and square.

**Do not nail corner post tight.**

### Step 3

If more than one length of corner post is required, overlap the upper corner post over the lower corner post.

### Splicing Outside Corner Post

Remove 1" from the nail hem and receiving channel of the bottom end of the top piece. Position uncut top end of the lower post under bottom edge of upper post allowing a 1/4" gap for expansion and contraction. (Fig. 3).

### *Splicing Inside Corner Post*

Cut 1" off all but the outer face of the upper portion of the bottom corner post. (Fig 4) Lap 3/4" of the upper post over the lower post, allowing 1/4" for expansion.

This method will produce a visible joint between the two posts, but will allow water to flow over the joint, reducing the chance of water infiltration.

### *Capping a Corner Post*

#### *Step 1*

Corner posts on homes with a second-story overhang need to be capped by making the cuts shown. Allow approximately 2" extra length on the corner post. Trim away everything except the 2 faces. Fold the flaps created over each other as indicated (Fig. 5).

#### *Step 2*

Drill a 1/8" hole in the center through both layers of vinyl, and install a pop rivet to hold them in place. Cut a notch in both layers to allow clearance for the corner (Fig. 5).

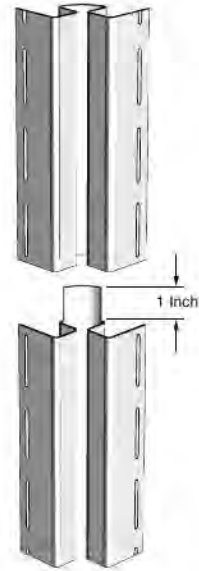

Fig. 4



Fig. 5

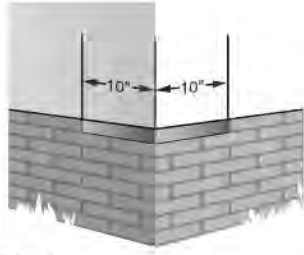

Fig. 1

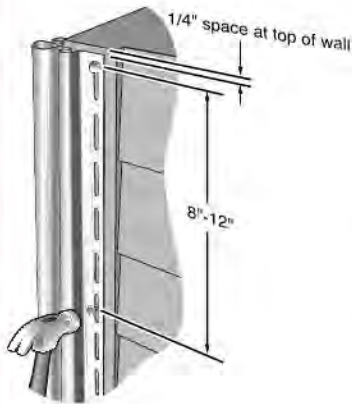

Fig. 2



Fig. 3

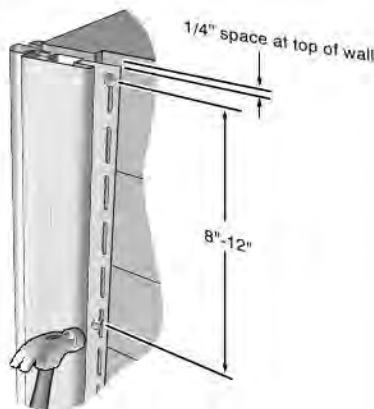

Fig. 4

### Step 1

A water-resistant material should be used to flash the inside and outside wall corners a minimum of 10" on each side before installation of the 3-piece corner system (Fig. 1).

### Step 2

Place the decorative corner starter on the outside wall corner, allowing a 1/4" gap between the top of the post and the eave or soffit, and extending 3/8" below the siding starter strip. Cut to length (Fig. 2).

Position a nail at the top of the upper full slot on both sides of the Decorative Corner Starter, leaving a 1/16" gap between the nail heads and the corner post nailing hem. The Decorative Corner Starter hangs from these nails. The balance of the nailing should be in the center of the slot, 8" to 12" apart, again leaving 1/16" between the nail head and the Decorative Corner Starter. This allows for proper expansion and contraction clearance. Make sure the Decorative Corner Starter is installed vertically straight and true.

**Do not nail corner post tight.**

### Step 3

For typical installations, cut two 3-1/2" or 5" Window & Door Surround lineals to the same length as the Decorative Corner Starter. Snap the locking side of a Window & Door Surround into one side of the receiving lock section of the Decorative Corner Starter (Fig. 3). Repeat the procedure for installing the other Window and Door Surround.

### Step 4

Make sure that all 3 parts are fully locked and line up evenly at the top and bottom. Fasten the Window & Door Surround lineals to the wall following the same nailing procedures outlined in Step 2 (Fig. 4).



The flashing detail shown is an industry accepted practice for minimum protection against water infiltration. These are various methods of flashing that will provide good results. Due to the wide variety of construction conditions that are beyond the control of the manufacturer, installers should consult applicable building codes and field to verify specific conditions needed for the type of window/door being used, construction method, and build location to ensure adequate water control.

### **General Preparation for All Doors and Windows**

The following instructions should be followed when applying window flashing:

#### **Step 1**

Apply the flashing on the underside of the window first (Fig. 1). The flashing should extend past the nail flanges of any accessory to prevent water infiltration through the opening. The flashing should be long enough to direct water over the nail flange of the last course of complete siding panels.

#### **Step 2**

Follow this application with flashing on the sides of the window. Make sure to overlap the bottom flashing (Fig.2).

#### **Step 3**

Finally, apply the flashing at the top of the window. Use this example as a model for applying flashing to other openings such as electrical outlets and doors (Fig. 3).

*NOTE: Sill the flashing is long enough to direct water over the nail flange of the last course of complete siding panels.*

#### **Step 4**

For even greater protection, tape the seams of the flashing.

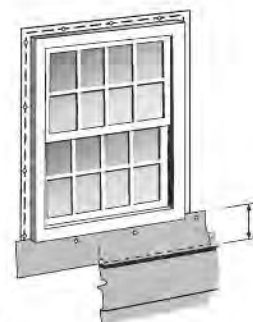

Fig. 1

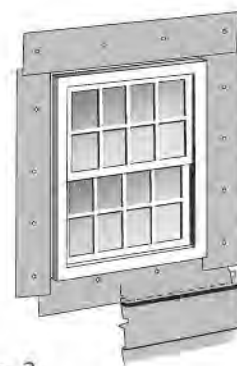

Fig. 2

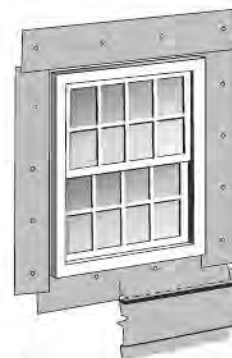

Fig. 3



Fig. 1

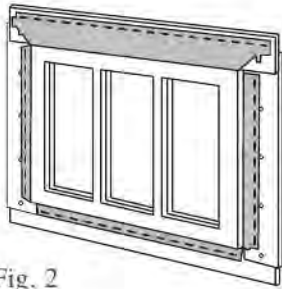

Fig. 2



Fig. 3



Fig. 4

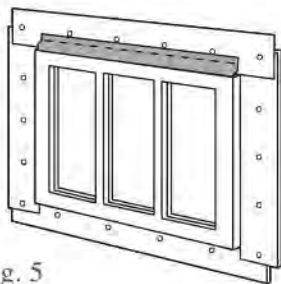

Fig. 5

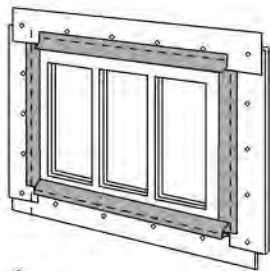

Fig. 6

### Starter Nailing Procedures

Fasten starter to subwall framing every 8" to 12", utilizing corrosion-resistant roofing type nails of sufficient length for proper securement. Nails should be driven flush in the center of the slots to take out starter looseness, but should not be overdriven (Fig. 4).

*NOTE: To hold vertical starter in position, place one fastener at the upper side of a nailing slot near the top of the starter.*

### Starter Strip Installation

#### Step 1

##### Standard Windows

*Option 1: Window and Door Surround butted to existing window casing.*

Install Window and Door Surround new construction starter strip flush to all sides of the window casing (Fig. 5). Starter strip should be cut to the length of each window side or casing, and installed with the lock edge toward the window. Starter locking edge should lightly and evenly contact the window casing for proper securement of Window and Door Surround.

##### Standard Windows

*Option 2: Existing window casings removed.* Shim outside edge of window jamb flush with subwall prior to siding installation (allow for thickness increase of added structural or insulating sheathings). Cut Window and Door Surround recessed starter strip to the length and width of the inside edge of the jabs. Install starter with the nailing strip facing outward to all sides of the window (Fig. 6).

### Recessed Windows

Cut Window and Door Surround recessed starter strip to the length and width of the recessed opening. Install starter with the nailing strip facing outward to all sides of the window recess as in Figure 6.

Lineals should be nailed in the centers of the slots leaving about 1/16" between the back of the fastener head and the face of the lineal to allow for expansion/contraction (Fig. 1).

*NOTE: to hold vertical lineals in position, place one fastener at the upper side of a nailing slot near the top of the lineal.*

#### Step 2

##### Top Window and Door Surround Lineal

Measure the top of the existing casing or opening and add 7-1/2" (for 5" lineals add 10") to the end of the Window and Door Surround. Measure 3-3/4" (for 5" lineals measure 5") in from the end of the lineal along the locking leg and make a small mark.

Use a straight edge to mark and cut a false miter (Fig. 2). Cut a 1-1/4" long drain tab (Fig. 3). Repeat procedure on other end and snap top lineal into starter.

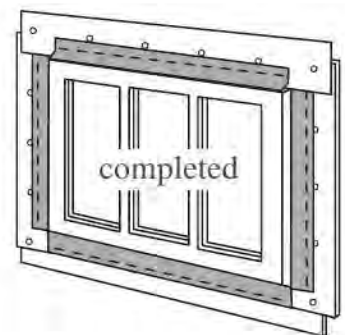

**Step 3****Side Window and Door Surround Lineal**

For the upright sides of the window, measure the existing casing or opening and add 7-1/2" (for 5" lineals add 10") to the end of the Window and Door Surround. On the end of the lineal that will install up, trim 1-1/4" notches in the Window and Door Surround as shown in Figure 1. The end of the lineal that installs down will use the same miter procedure as top lineal (Fig. 2). Repeat procedures on other side lineal and install into starter and top lineal miters (Fig. 3).

**Step 4****Bottom Lineal**

Measure the bottom of the existing casing or opening and add 7-1/2" (for 5" lineals add 10") to the end of the Window and Door Surround. Trim 1-1/4" notches in the Window and Door Surround as shown in Figure 1. Repeat this procedure on the opposite side. Install bottom lineal into starter and side lineal miters.

*NOTES: The above illustrations show 3-1/2" Window and Door Surround. However, 5" Window and Door Surround will follow the same installation procedures.*

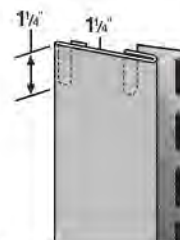

Fig. 1

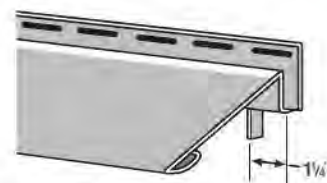

Fig. 2

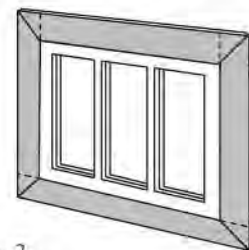

Fig. 3



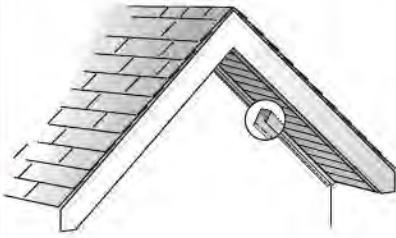

Fig. 1

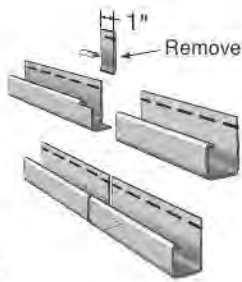

Fig. 2

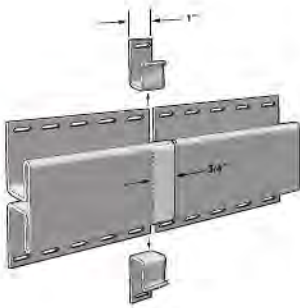

Fig. 3

### *Gable and Trim*

Before applying siding to the gables, the J-Channel should be installed to receive the siding at the gable ends (Fig. 1).

#### **Step 1**

Where the left and right sections meet at the gable peak, let one of the sections butt into the peak with the other section overlapping.

#### **Step 2**

A miter cut should be made on the face flange of this piece for better appearance.

#### **Step 3**

Fasten the J-Channel every 8" to 12".

#### **Step 4**

If more than one length of J-Channel is required to span a wall surface, be sure to notch and overlap the J-Channels by 3/4".

### *Overlapping Accessories*

Accessories such as a J-Channel, undersill trim, and H-Mold should be overlapped to avoid gapping during expansion and contraction. Cut accessories as shown in Fig. 2 & 3 at left.

*NOTE: When overlapping accessory, make sure it can expand at least 1/4".*

**Step 1**

Install the flashing before the J-Channel to prevent water infiltration along the intersection of a roof and wall.

**Step 2**

Keep the J-Channel at least 1/2" from the roofline. Chalk a straight line up the roof flashing to guide J-Channel installation.

*NOTE: Vinyl J-Channels should not be in direct contact with roofing shingles, since the shingles may transfer enough heat to the vinyl J-Channel to cause distortion. With dark shingles, or a south or west exposure, it is recommended to either use a metal J-Channel or raise the vinyl J-Channel approximately 2" off the shingles and install, having first ensured that there is sufficient flashing behind the J-Channel to prevent water infiltration.*

**Step 3**

Overlap the J-Channel (lapping the upper piece over the lower piece) if it is necessary to use more than one piece.

**Step 4**

Extend the J-Channel past the edge of the roof, channeling water into the gutter, in order to ensure proper runoff.

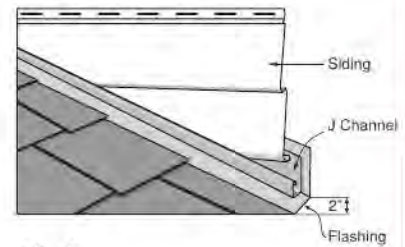

Fig. 1

# HORIZONTAL SIDING INSTALLATION

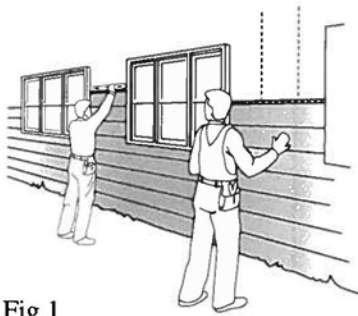

Fig. 1

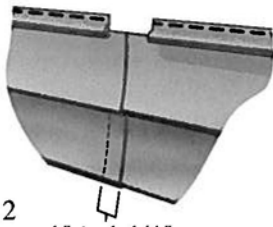

Fig. 2

1" to 1-1/4"

*NOTE: For Beaded Horizontal Siding see special lapping instructions on next page*

## **Step 1**

The first panel (or course) should be placed in the starter strip and securely locked along the entire length of the siding panel.

*NOTE: Always overlap joints away from entrances and away from the point of greatest traffic. This will improve the overall appearance of the installation.*

## **Step 2**

Be sure to fasten the panels according to the instructions on page 14. Allowance should be made for expansion and contraction by leaving a 1/4" gap between the siding and all corner posts and channels (increase to 3/8" when installing in temperatures below 40°F).

## **Step 3**

Do not drive the head of the fastener tightly against the nail slot. Leave 1/16" between the fastener head and the panel nailing strip.

## **Step 4**

Do not stretch the panels up when fastening. Panel locks should be fully engaged; however, the panels should not be under vertical tension or compression when they are fastened.

## **Step 5**

Since vinyl siding moves as the temperature changes, make certain that the vinyl panels can move freely in a side-to-side direction once fastened.

## **Step 6**

Check every fifth or sixth course for horizontal alignment (Fig. 1). [Check siding alignment with adjoining walls]

## **Step 7**

When panels overlap, make sure they overlap approximately 1" to 1-1/4" (Fig. 2).

*NOTE: Overlap with factory cut ends whenever possible. If you must use cut ends, duplicate the factory notches before installing.*

## **Step 8**

Stagger the siding end laps so that no two courses are aligned vertically, unless separated by three courses.



## Beaded Horizontal Siding

Beaded panels are factory notched in three places (Fig. 1). For best results, overlap panels using factory notched ends only. **This panel should be overlapped 1" due to the unique design of the locking and lapping system.** Overlapping more than 1" will result in less than optimal laps and increase the chances of panel restriction (Fig. 2). For easiest panel installation, start locking the panel at one end and tap the lock into place toward the other end. This panel will not lock by pushing straight up as in standard panel installation.

*TIP Always overlap joints away from entrances and away from the point of greatest traffic. This will improve the overall appearance of the installation.*

## Fitting Siding around Fixtures

For handling protrusions around the wall, refer to the figure (Fig. 3) for hand fabricating, or use manufacturers' accessories specifically designed for this purpose. In addition, the following tips are suggested:

- Always begin a new course of siding at the fixture to avoid excess lap joints.
- Cut a slot 1/4" bigger than the fixture. (Fig. 3)
- When cutting, match the shape and contour of the obstruction. (Fig. 4)

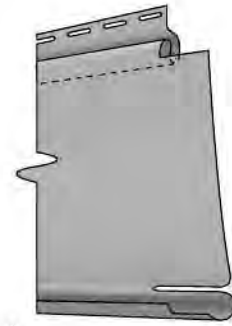

Fig. 1

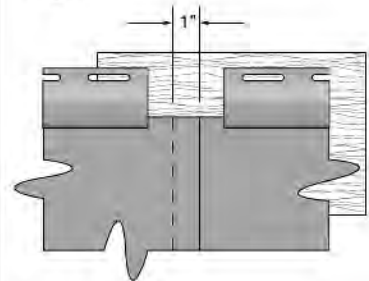

Fig. 2

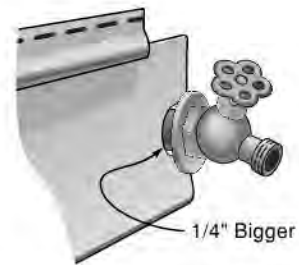

Fig. 3

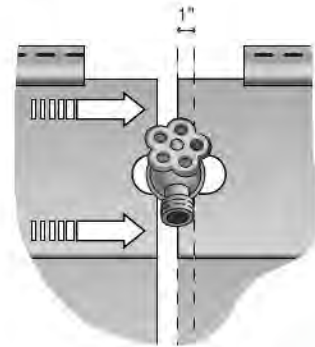

Fig. 4



Fig. 1

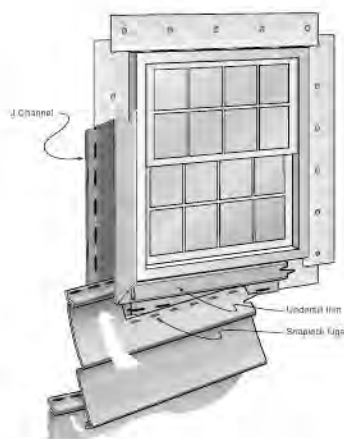

Fig. 2

### Fitting under Windows

To mark the section to be cut, perform the following:

#### Step 1

Hold the panel under the window and mark the width of the window opening on the panel. Add 1/4" to both sides to allow for expansion and contraction of the siding. These marks represent the vertical cuts (Fig. 1).

#### Step 2

Lock a small piece of scrap siding into the lower panel next to the window. This will be used as a template for the horizontal cuts. Mark it 1/4" below the sill height (Fig. 1).

#### Step 3

Transfer the horizontal measurement to the panel, which will be installed under the window (Fig. 1).

#### Step 4

Cut the panel with tin snips and/or a utility knife.

The cut panel is now ready for installation under the window. Perform the following:

#### Step 5

Install undersill trim under/over the window, inside previously installed J-channel as a receiver for the cut siding. Undersill trim is used any time the top lock or bottom lock has been removed from the siding. Furring may be needed to maintain the face of the panel at the desired angle.

#### Step 6

Use a snaplock punch to place lugs facing out in the cut edge of the panel every 6"-10".

#### Step 7

Install the siding panel, making sure the lugs (from the snaplock punch) lock into the undersill trim (Fig. 2).

## *Finishing at the Top*

Before the final course of siding is installed on the wall, any soffit accessories that will be used on the eaves must be installed. See the soffit installation section (Page 37).

## *Gable Ends*

To install around gable ends, make a pattern that duplicates the slope of the gable (Fig. 1).

### *Step 1*

Lock a short piece of siding into the gable starter course (i.e., the last course before the gable starts).

### *Step 2*

Hold a second piece of siding against the J-Channel at the slope of the gable. Mark the slope with a pencil on the short piece of siding.

### *Step 3*

Remove the short piece and cut along the pencil line as a pattern for the gable angle cuts. Repeat the procedure on the opposite side of the gable.

### *Step 4*

It may be necessary to fasten the last panel at the gable peak with a trim nail. Use a 1 1/4" to 1 1/2" nail. **[This is the only time a nail should be placed in the face of the vinyl siding (Fig. 2).]**

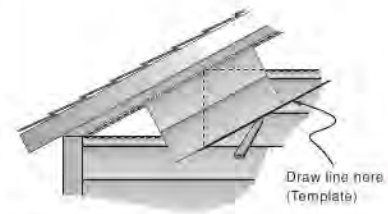

Fig. 1

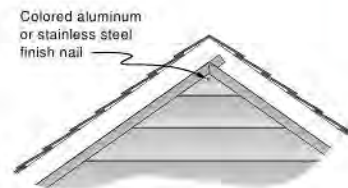

Fig. 2



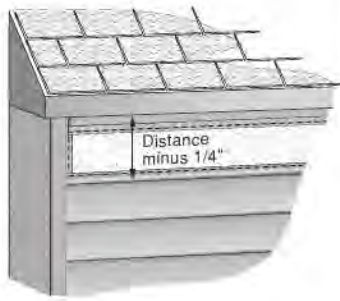

Fig.1

The last course of siding will generally need to be cut to fit the eave opening (Fig.1).

Install undersill trim under the eave or overhang as a receiver for the cut siding. Undersill trim is used anytime the top or bottom lock has been removed from the siding. Furring may be needed to maintain face of the panel at the desired angle.

Measure from the top of the undersill trim to the bottom of the upper lock on the previous course of panels. Subtract  $1/4"$ . Mark this dimension on the panel to be cut, measuring from the bottom edge of the panel.

Using a snaplock punch, punch the vinyl siding along the cut edge every  $6"$  to  $10"$ , so the raised lug is on the outside face.

Install the siding panel, making sure the lugs (from snaplock punch) lock into the undersill trim.

**Transition from Horizontal to Vertical (Fig. 1)**

**Step 1**

Position lower J-Channel or H-mold at desired location for transition to vertical siding.

**Step 2**

Position undersill trim in lower side of J-Channel or H-mold and line up nailing slots when fastening.

**Step 3**

Cut last course of horizontal siding to fit. Snaplock the top of the panel to fit. Snaplock the top of the panel every 6" to 10" and install.

**Step 4**

If using J-Channels, bend and install flashing to protect the seam between the channels for increased moisture protection. Install upper J-Channel.

**Step 5**

Cut and install vertical siding panels per instructions.

**Continuous Vertical Siding Installation (Fig. 2)**

*TIP: 1/8" weepholes can be drilled in the upper J-Channel to allow water drainage.*

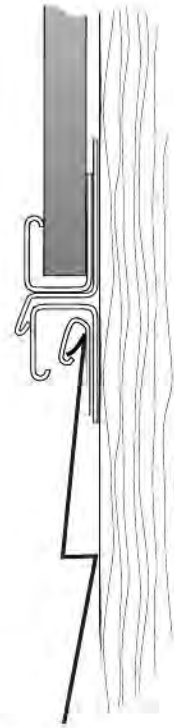

Fig.1

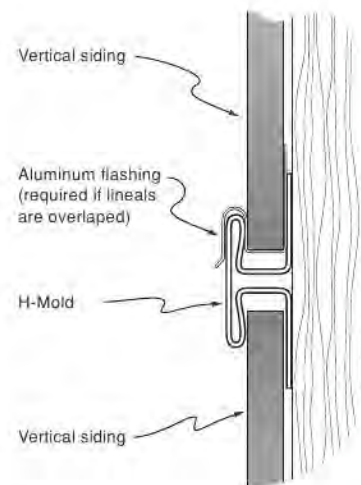

Fig.2

# VERTICAL SIDING INSTALLATION

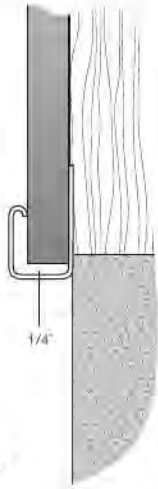

Fig. 1

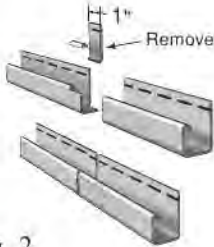

Fig. 2

When installing vertical siding, follow these steps:

## Preparation

### Step 1

Install a solid, nailable sheathing prior to applying vertical siding, if needed, to level the surface or provide sufficient material for proper fastener penetration. Use minimum 7/16" plywood, OSB or equivalent.

### Step 2

Snap a level chalkline around the base of the sidewalls. Typically, the chalkline is positioned so that the bottom of the J-Channel is 1/4" below the lowest point on the wall that will be sided. (See the "Installing Accessories" section for tips on snapping a chalkline.) Install a J-Channel along the chalkline as a receiver for the vertical siding.

## Installation

### Step 1

Install vinyl outside corner posts, inside corner posts, and door/window trim, and/or J-Channel as needed. See previous sections for corner post installation techniques.

### Step 2

Install top and bottom J-Channel: Apply J-Channel along the top and bottom of the walls to receive the siding panels (Fig. 1).

**A** Install the bottom J-Channel. Overlap J-Channels 3/4". To do this, cut out a 1" section of the nailing flange and face return (see Fig. 2).

**B** Install inverted J-Channel along the top of the wall, under the eave. Overlap J-Channels 3/4" to allow for expansion.

*NOTE: If you're going to install soffit, you may want to install the receiving channels for the soffit prior to this point.*



If a wall requires more than one course of siding, you can proceed in one of two ways (see illustrations below).

Use two lengths of J-Channel, back-to-back and flashing, at the joint between the two courses (Fig. 1). Or use a double channel lineal (H mold) and flashing (Fig. 2).

Panel installation should begin at the end of a wall section at a corner post or J-Channel. An undersill trim piece should be installed and fastened inside the opening of the corner post or J-Channel to secure the edge of the first and last course of siding. Cut off the locking edge of the first course, snaplock punch the cut edge every 6" to 10", and snap the edge into the secured undersill trim. Cut and install last course in similar fashion. (Fig. 3)

*TIP: A furring strip may be needed behind the undersill trim before fastening to shim it out and maintain the lines of the vertical panel.*

Maintain a 1/4" gap at each end of panels where they butt to trim pieces such as J-Channel. Failure to maintain this gap may result in permanent panel warpage. Maintain a 3/8" gap if installing at temperatures 40° F or below.

Fasten panels at least every

12" through the middle of the nailing slots. Maintain 1/16" minimum clearance between the fastener crown and nail hem of panel.

**Special note for vertical panel installation:** Vertical panels should be cut to allow clearance as specified. Panels should be positioned on wall allowing equal clearance top and bottom. One fastener should be placed at the top of a nail slot within the upper 12" of the panel when installed. The panel will hang on this fastener and will expand in both directions rather than only upward. Balance of fastening should take place in the center of the nailing slots (Fig. 1).

Undersill trim should be installed inside J-Channel, or built-in window receiver on the sides of windows and/or doors to secure cut edge of vertical panels. Vertical panels should be snap-locked before insertion into the undersill trim (Fig. 2). A furring strip may be needed behind the undersill trim to maintain the lines of the vertical panel.

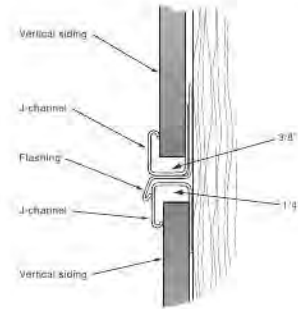

Fig. 1

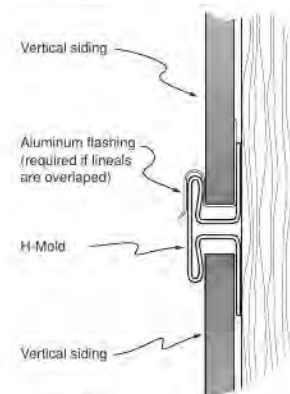

Fig. 2

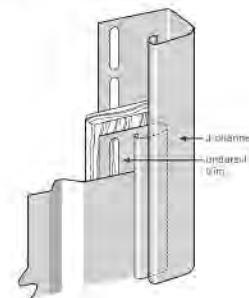

Fig. 3

## Basic Installation

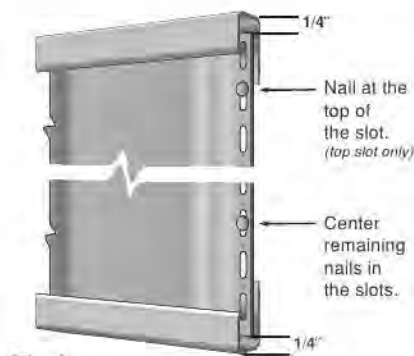

Fig. 1

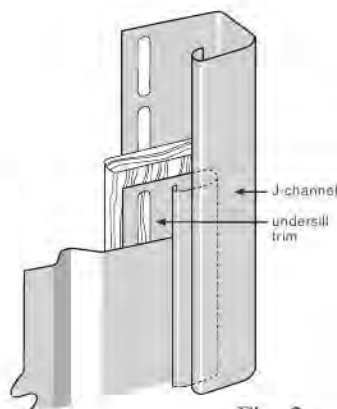

Fig. 2

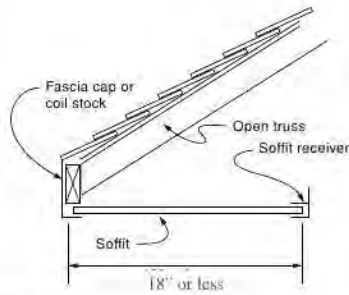

Fig. 1

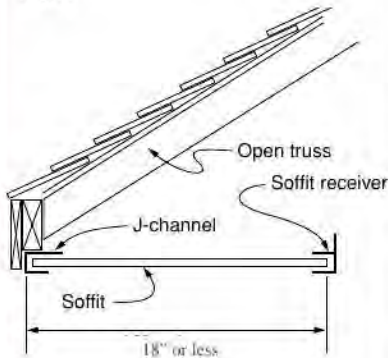

Fig. 2

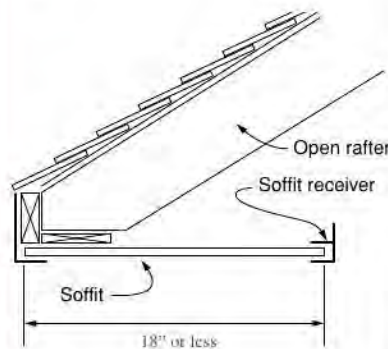

Fig. 3

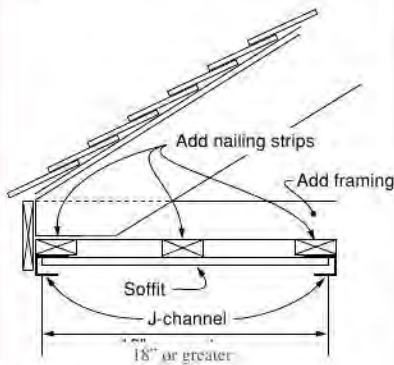

Fig. 4

Soffit is the name given to materials used to enclose the underside of eaves and porch ceilings. The installation of soffit will determine the positioning of the inside and outside corner posts. It also is necessary to complete the soffit, or install the soffit moldings, before the final course of siding is installed on the wall.

Vinyl soffit is designed to be easily installed in residing or new construction. Soffit panels are similar to vertical siding. Manufacturers produce both solid and vented panels.

*NOTE: Proper attic ventilation is important for any home. Consult a local building official for the appropriate requirements for a specific geographical area, and use vented soffit or other vented products as necessary.*

### Preparation

Inspect and plan the job in advance. For residing applications, nail down any loose panels, boards or shingles. Check surfaces for straightness and fur when necessary. Surfaces should be uniform and straight from various viewing angles.

The procedure used to install soffit depends on the construction of the eaves. There are two different types of eaves:

### TYPE ONE

Open eaves with exposed rafters or trusses are typical of new construction. Open eave installation procedures are also used when removing damaged soffit during a residing project.

### TYPE TWO

Enclosed eaves (eaves with a wood or plywood soffit already in place) are typical of residing projects.

### Installation Over Open Eaves:

#### Step 1

Install receiving channels (F-Channel or J-Channel).

There are several ways to install receiving channels for soffit. You can use accessories such as J-Channel or F-Channel. The best approach is to select a method that works most effectively with the construction techniques used to create the eave.

Examine the illustrations at left and find one that most closely resembles the construction methods used for your particular project (Figs. 1 through 4).

Install the receiving channels following the details shown in the illustrations. Nail channels every 12", positioning the nail in the center of the slot. Fasten channels, just snug to take out excessive play. Do not over-drive fasteners.

*NOTE: Recommended nailing for soffit panels is 16" on center; however, if the eave span is over 18", nailing strips must be installed (Fig. 4). In areas with high wind restrictions, nailing should not exceed 12" on center.*

**5-step procedure continued:****Step 2**

Measure from inside the wall molding to the fascia board. On soffit panels 36" or less in length, subtract 1/4" for expansion. Panels over 36" in length require 1/4" clearance at each end of the soffit panel. Mark this dimension on a soffit panel and cross cut using a power saw with a reversed finetooth blade or snips. Cut one or two panels at a time, carefully advancing the saw through the vinyl.

**Step 3**

Insert one end of the panel into the channel on the wall, then the other end into the channel at the fascia board (Fig. 1).

- It might be necessary to flex the panel slightly to insert it into the second channel.
- Make certain the panel is perpendicular to the wall, and then nail. Depending on the installation method being used, nails will be hammered either into a nailing strip or fascia board.
- Do not nail soffit panels tightly.
- Continue the installation by locking and nailing the panels. Make certain the panels are fully locked along their entire length.

**Step 4**

To turn a corner, measure from the channel at the wall corner to the channel at the corner of the fascia board (Fig. 1). Subtract 1/4" for expansion. Cut and install H-Molding lineal or back-to-back J-Channel. If necessary, install nailing strips to provide backing for the lineal. Miter cut the corner soffit panels and install as described in Step 3.

**Step 5**

Install vinyl or aluminum fascia as needed to finish installation. (see section on fascia installation)

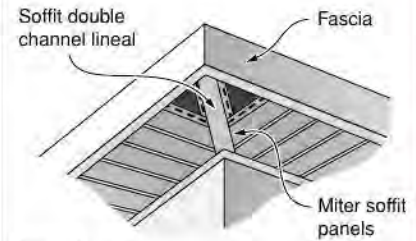

Fig. 1



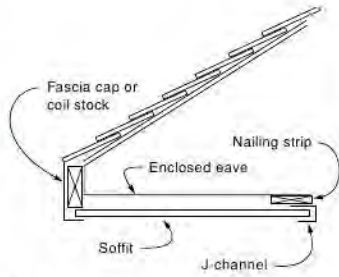

Fig. 1

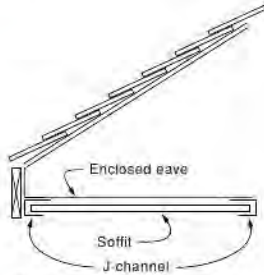

Fig. 2

### ***Installation Over Enclosed Eaves***

The procedure used to install soffit over enclosed eaves is almost identical to that used for open eaves. The major difference is the installation of the J-Channel at the wall line rather than F-Channel (Figs. 1 and 2).

Determine the preferred method of installing soffit at the fascia board.

*NOTE: If the existing soffit is rotted or damaged, remove it completely before installing vinyl soffit, then use the instructions for open eaves.*

## Vinyl Fascia

### Step 1

In applications requiring both soffit and vinyl fascia, install a frieze back plate ("F"-channel) on the bottom of fascia board, and the complete soffit installation (Fig. 1). Prepare for installation of fascia panel by applying undersill trim along the top of the fascia board. Measure from the bottom of the F-Channel to the top of the undersill trim and deduct 1/8" (Fig. 2). This is the width to cut fascia panel before installation. Use a snaplock punch tool on the fascia panel to punch out raised slots (Fig. 3).

### Step 2

Hook the bottom lock of the fascia panel over the F-Channel, (which already is installed on the bottom of the fascia board). Then insert the top edge of the fascia into undersill trim. This will hold the fascia firmly in place. Run F-Channel straight to avoid waviness in fascia.

**Do not nail vinyl fascia under any circumstances.**

### Step 3

When overlapping fascia panels, first cut a notch in the underlying panel. The notch should be 1/8" deep by 1-1/2" long. Slip the notched panel into the adjacent panel (Fig. 4).

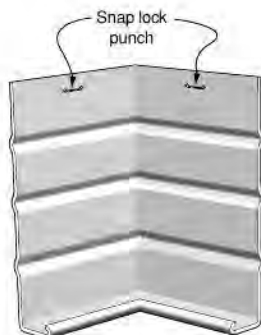

Fig. 6

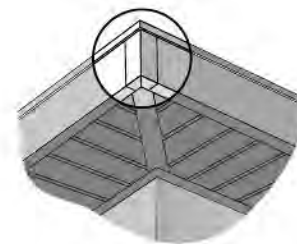

Fig. 7

### Step 4

To fabricate a corner cap (Fig. 5), cut a piece of fascia 5 1/2" in length. Mark a vertical centerline on the back. Cut out a 90° section of bottom flange from the center leaving a 45° on each side (Fig. 6).

### Step 5

Using a hand seamer or metal straightedge, make a fold along the vertical centerline forming a right-angle corner as shown.

### Step 6

Punch the top edge of the corner cap with the snaplock punch. The corner cap is then hooked onto the bottom ends of the fascia, and the top is snapped into place in the undersill trim (Fig. 7).

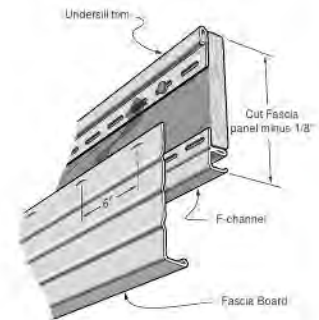

Fig. 1

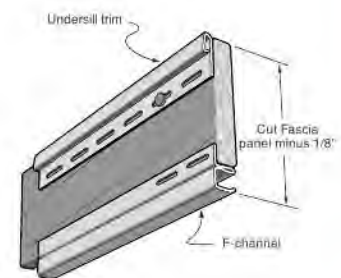

Fig. 2

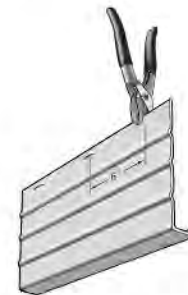

Fig. 3

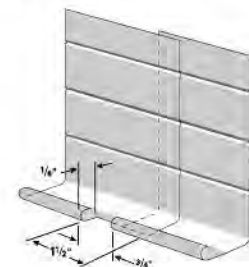

Fig. 4

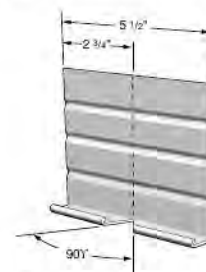

Fig. 5

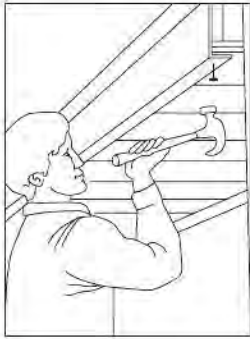

Fig. 1

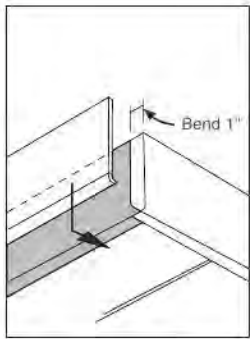

Fig. 2

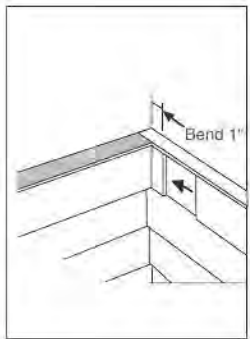

Fig. 3

### Aluminum Fascia

Installing aluminum fascia in conjunction with vinyl soffit:

#### Step 1

Install vinyl soffit per instructions stated previously. Choose the soffit installation method that applies to your specific needs.

#### Step 2

Install metal drip edge, gutter trim, undersill trim, etc. along the top of the fascia board to receive and secure the top edge of the aluminum fascia.

#### Step 3

Measure from the lower side of the vinyl soffit panels to the top of the trim installed on the upper side of the fascial board. Deduct approximately 1/8" from this dimension and cut fascia panel using snips, or score and break with a utility knife and straight edge.

*NOTE: Nails or fasteners installed through the bottom of the aluminum fascia panel may penetrate the ends of the vinyl soffit panels in some installations. The following procedures are recommended if this situation occurs.*

- \* Line up the aluminum fascia fasteners with the V-grooves in the vinyl soffit panels to avoid cupping the soffit panel faces.
- \* If vinyl soffit panels are over 24" in length, enlarge the fastener hole in the vinyl soffit panel 1/4" larger than the fascia fastener diameter. This will allow the soffit panels to expand normally and avoid potential buckling.

#### Step 4

For the best appearance, we suggest that you do not face nail aluminum fascia. The recommended procedure is to slip the top edge of the fascia into the drip edge (or other installed trim) and secure the fascia in place with nails or screws installed through the bottom side (Fig.1).

#### Step 5

Outside corners: bend a 1" flange at a 90-degree angle so it turns the corner. Then cut the overlapping fascia and position as shown (Fig. 2).

Inside corners: Use same technique as outside corners (Fig. 3).



## Porch Ceilings

The procedures to install a porch ceiling are in many ways similar to those used to install soffit. These procedures vary slightly, depending on whether the installation is a new construction or a residing project.

*INSTALLATION TIP: In hot climates or in attics with limited ventilation, it is advisable to install solid sheathing to the underside of the porch ceiling joists. This will protect vinyl soffit panels from excessive heat.*

## New Construction

### Step 1

Begin by installing receiving F- or J-Channels on all four sides of the porch (Fig. 1). If F-Channels are being used, nail them to the existing walls or porch beams. If J-Channels are being used, a nailing base will have to be installed.

### Step 2

When planning to use light blocks to attach external light fixtures, install them to adequate backing.

### Step 3

Plan the layout of the ceiling panels to achieve an even balance or to align with adjacent work. If the ceiling joists run parallel to the direction of the soffit panels, additional 1" x 3" wood furring nailing strips will have to be installed. Install these nailing strips perpendicular to the ceiling joists, placing a strip every 12" to 16".

### Step 4

Invert the J-Channels and nail them to the underside of the wood strips along the perimeter of the ceiling area.

### Step 5

Install an undersill trim shimmed down by a furring strip into the J-Channel or F-Channel on the starting end (Fig. 2). Cut the hook side (opposite the nailing hem) off the panel and install snap locks every 6" to 10". Install the soffit panel locking

the cut edge into the undersill trim and nailing the other side through the nailing slots. **DO NOT NAIL TIGHTLY.** Install remaining panels.

### Step 6

For large areas where more than one panel length is needed, use a double channel lineal H mold or back-to-back J-Channel to separate the sections.

*NOTE: On large ceiling areas with 2 or more panel lengths, run all sections at once to maintain the alignment of the soffit panels. Do not run one section completely before beginning of next section.*

### Step 7

To install last soffit panel, use same technique as outlined in step 5 and Figure 2, except that the nailing hem sidewall be trimmed and snap lock punched every 6" to 10". Install the final panel by locking the hook side of the panel on the previous panel and inserting the cut edge into the undersill trim for a secure fit.

## Residing

### Step 1

Check to be sure the existing ceiling can serve as a solid nailing base.

### Step 2

If the existing ceiling is solid, remove all existing moldings and fixtures from the ceiling and begin by nailing inverted J-Channels along the perimeter of the ceiling area. Then follow Steps 2 through 7 in the instructions under "New Construction". With a solid ceiling, however, additional nailing strips are not necessary. Use the existing ceiling as the nailing base for the panels.

If the existing ceiling is not solid, install nailing strips to provide a secure nailing base, then install the J-Channels. Additional nailing strips should be installed if the ceiling panels are to run parallel to the ceiling joists. Follow the instructions in Steps 2 through 7 for "New Construction".

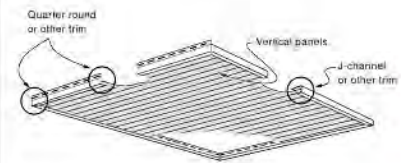

Fig. 1

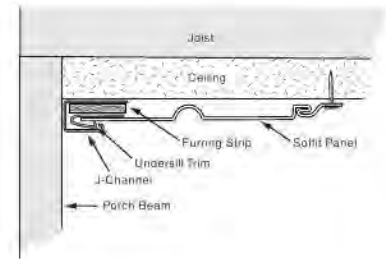

Fig. 2

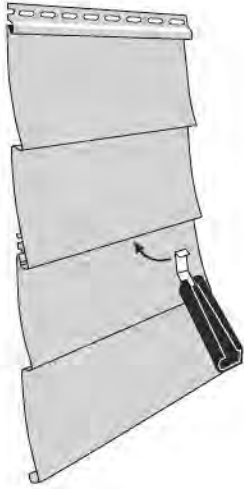

Fig.1

### *To remove a panel for any reason:*

To remove a damaged panel, insert the hook end of a zip tool into the lock between the damaged panel and the panel above. Pull downward. This will allow access to the damaged panel's nail flange. Remove the nails securing the panel.

*NOTE: The nails may be allowed to stay in the wall if they are driven flush with the substrate after the damaged panel is removed. Remove damaged panel and install a new panel, then use the zip tool to lock the new panel into the panel above.*

This section will discuss shutters as the primary item, but molded door surrounds, house number plaques and various decorative millworks will follow the same principles.

**General recommendations:**

Position shutter in desired location on side of window or door. Drill a small pilot hole through the shutter and siding that is the appropriate size for the fastener being used. Remove the shutter and enlarge the hole in the siding 1/4" larger than the attachment screw (e.g. 1/8" fastener would require a 3/8" hole in siding). This will allow siding to expand and contract with temperature changes. Install shutter and tighten attachment screws.

**Do not over-tighten and bind siding.**

*NOTE: In some cases, shutters will be installed on both ends of the same siding panel. An example of this is when two windows are in close proximity to one another on the same wall. Listed at right are two options for successfully handling this situation and avoiding panel distortion.*

**Option 1**

Create a lap joint in between the window prior to shutter installation on the courses of siding that will receive the shutter attachment screws. Position the shutter and complete installation following general recommendations above.

**Option 2**

Stagger position shutter attachment screws on each shutter so they are attached through a different course of siding. Position the shutter and complete installation following general recommendations above (Bottom Fig. 1).

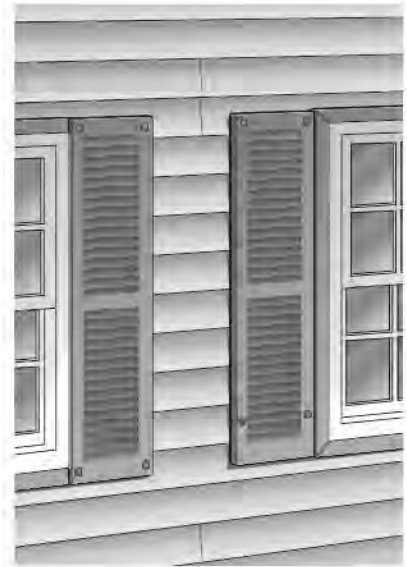

Fig. 1



**Tools Required**

- Hammer
- Pencil
- Snips
- Nail Slot Punch
- Circular Saw with 18-24 Tooth Carbide Tipped Blade (not reversed)
- Chalk Line
- Utility Knife
- Tape Measure
- Level
- Corrosion-Resistant Siding Nails or Screws

**ACCESSORIES**

- Outside Corner Post
- Shingle or Hand-Split Standard
- Inside Corner Post  
(j-channel can be used as inside corner)
- Starter strip
- 3/4" minimum J-channel
- Cedar Finish Trim

Note: Use universal cedar starter strip and accessories with at least 3/4" pocket depth.

**Important**

**A SOLID NAILABLE SHEATHING, SUCH AS PLYWOOD OR OSB IS NECESSARY FOR A PROPER AND SECURE INSTALLATION.**

- This product is for exterior use only and should be installed on flat, vertical walls to maintain an even appearance.

- Panels should be acclimated to air temperature by placing them in the general work area at least one hour prior to installation. Air temperature should be checked when installing the first course of each new wall to determine the amount of panel overlap. As air temperature changes, it is NOT necessary to go back and adjust the spacing of previously installed panels.

- Allow 1/4" clearance for all stops, such as corner posts and J-channels. When installing product in very cold temperatures (<40°F), allow 3/8" clearance for expansion and contraction.

- In order to finish the wall without a short course at the top, measure down from the soffit and adjust as needed.

- For Maximum wind load nail through center of Nail Slots every 8".

- When nailing through slots, always nail in CENTER of the slot. DO NOT NAIL TIGHT. Panels must be able to move to allow for expansion and contraction caused by temperature change.

- See nailing instructions for specific panels.

**Maintenance**

- To clean, use mild soap with warm water to remove dirt, dust or surface stains that may collect from time to time.

- Product should NOT be painted.

## STARTER

- Snap a chalk line on all walls to align the top edge of the starter strip (or J-channel).
- Installation of starter strip (or J-channel) and panels should begin on the lowest wall.
- Install starter strip (or J-channel) along the chalk line, nailing in nail slots to allow for penetration into solid wood. Wood stripping may be required to accomplish this. Nail every 6-8".

## DO NOT NAIL TIGHT.

- To allow for movement, install starter strip (or J-channel)  $\frac{1}{2}$ " from corner post (see Figure 1).

## ACCESSORIES

- If using conventional corner post, nail at least every 12" and **DO NOT NAIL TIGHT**
- Install all accessories including J-channel, corners, etc.  
*Note: accessories must have  $\frac{3}{4}$ " receiver.*

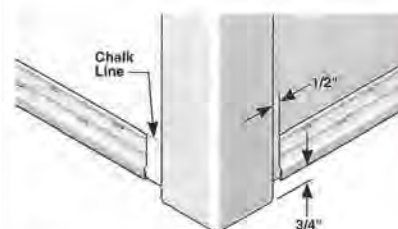

Fig.1 Standard Corner Post



Fig. 1

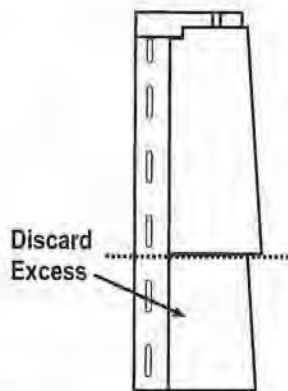

Fig. 2

Install starter strip by nailing every 12" as low as possible, starting with lowest wall and working around the house.

**NOTE:** Starter strip **MUST** be installed before corner post. Make sure Starter Strip does not overlap or butt Corner Post.

1. Align the bottom of the nail hem flange of the outside corner post with the bottom of the starter strip (see Figure 1).

2. Nail through center hole on both sides of Corner Post.

3. Continue nailing Corner Post every 8" through center of Nail Slots.

**NOTE:** Do not nail tight.

4. Stack additional corner posts ensuring they interlock with the top corner post nailing fin overlapping the bottom corner post nailing fin.

**NOTE:** On the Shingle corner the "V" molded into the top and bottom of the nailing fin will create an "X" when properly installed.

5. Repeat Steps 3 and 4 as needed.

6. If top of Corner Post is exposed, field form a cap.

**NOTE:** To allow for the unevenness of the structure, before nailing center nail holes, adjust the Corner Post so that it aligns with the panel.

### Installing Modified Corner Post

When necessary to remove a portion of a Corner Post to complete a wall, the remainder of the Corner Post may be used to start a different corner location.

1. Cut and remove section below butt (Figure 2).

2. Align the bottom of the nail hem flange of the cut post to the bottom of the starter strip. Nail Corner Post.

**NOTE:** Do not nail tight.

3. Stack additional corner posts ensuring they interlock with the top corner post nailing fin overlapping the bottom corner post nailing fin.

**NOTE:** On the Shingle corner the "V" molded into the top and bottom of the nailing fin will create an "X" when properly installed.

4. Repeat step 3 as needed.

**NOTE:** Panels can also be used with corner posts with foam inserts, Window Casing Trim, and 3/4" J-Channel.



## SHINGLE AND HAND-SPLIT PRODUCT INSTALLATION NOTES

Set panels at job site to allow them to reach the air temperature. Starter strip and/or J-channel and corner post must be installed before panels are installed.

**Starter strip/J-channel** – Use chalk line to mark level for starter. Nail starter every 12" in lowest set of nail slots.

**Corner post** – If using conventional corner post, nail at least every 12" and do not nail tight. If using Shingle or Hand-Split outside corner post, see corner post carton for installation instructions. Panels can be cut with a circular saw or tin snips.

**Panels must be installed from left to right** over a nail able surface that is covered with house wrap, as siding alone is not intended to be a water or moisture barrier. Start with the lowest wall on the house. To allow for panel movement with temperature change, allow 1/4" gap in all corner posts and J-channels.

### INSTALLING PANELS

Align the top left side below the arrow on the previously installed panel (See Figure 2).

Apply pressure to middle butt and slide panel up until the top of the panel aligns with the bottom of the nail slot (See Figure 3).

Apply pressure to bottom butt and slide panel up to fully engage (See Figure 4). Slide panel left or right to align with the proper temperature mark (See Figure 5) only on the first courses.

### NAILING PROCEDURE

Do NOT nail tight.

First, nail through center nail hole – not nail slot. If using partial panel, find center of nail hem and drive nail through center of nail hem (*not in nail slot*).

Next, nail every 8" through center of the nail slot.

Last, nail through slot in right side tab.

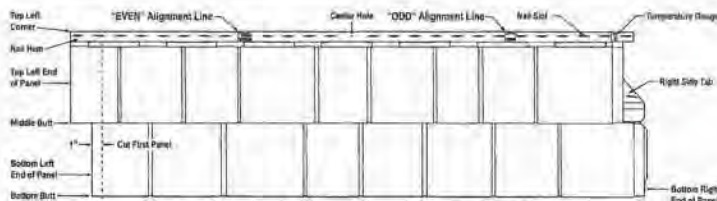

Fig. 1

### 1st Course, 1st Panel

Measure and cut 1" from bottom left end of panel (See Figure 1).

Leaving 1/4" gap at end of panel, insert left end of panel in to corner post and lock onto starter. Nail panel according to "NAILING PROCEDURE".

### 1st Course, 2nd Panel

Use full panel and install according to "INSTALLING PANELS".

Nail panel according to "NAILING PROCEDURE".

Repeat for remaining full panels in 1st course using the temperature gauge to set the panel before nailing.

### Last Panel of Each Course

Measure from the appropriate temperature mark on the previous panel into the corner post, allowing 1/4" gap for movement. Mark and cut this distance from top left corner of panel.

*NOTE: To reduce waste, pieces cut from last panel on each course can be used as starter pieces on adjacent walls.*

Install panel according to "INSTALLING PANELS" and nail according to "NAILING PROCEDURE".

### 2nd Course (and all remaining even courses), 1st Panel

Measure from inside of corner post to EVEN line on nail hem of 1st panel of course below. Cut piece by measuring this distance from bottom right end of new panel.

Install panel by aligning the bottom right end with the EVEN line on nail hem below. Install according to "INSTALLING PANELS" and nail according to "NAILING PROCEDURE".

Install remaining panels in course by lining panels up to "EVEN" Line on course below.

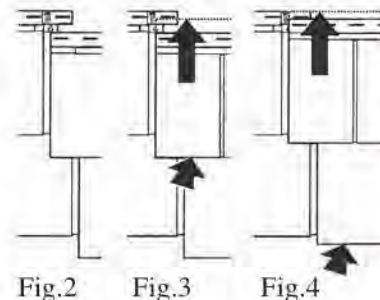

Fig. 2

Fig. 3

Fig. 4

Air Temperature:	100°F	70°F	30°F
Panel Overlap			

Fig. 5

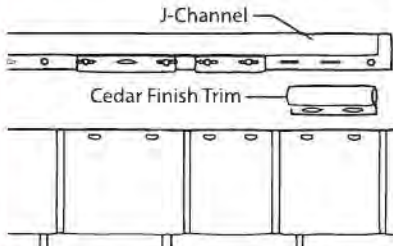

Fig.6

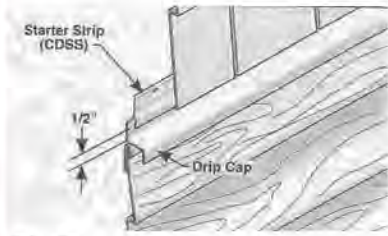

Fig.7

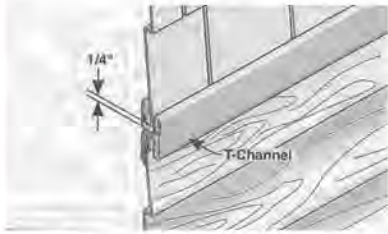

Fig.8

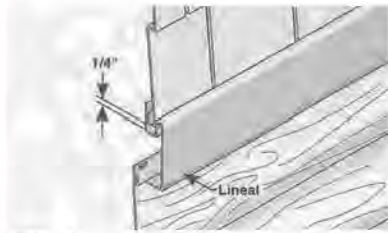

Fig.9

### **3rd Course (and all remaining odd courses), 1st Panel**

Measure from inside of corner post to ODD line on nail hem of 1st panel of course below. Cut piece by measuring this distance from bottom right of new panel.

Install panel by aligning the bottom right side with the ODD line on nail hem below.

Install according to **“INSTALLING PANELS”** and nail according to **“NAILING PROCEDURE”**.

Install remaining panels in course by lining panels up to “ODD” line on course below.

### **INSTALLING AROUND WINDOWS**

Keep the panel pattern across all openings. When installing under windows, cut panels to required width. Use snap lock tool to punch tabs in top edge of panel, and engage into cut pieces of Cedar Finish Trim. The Cedar Finish Trim can also run continuously across the top of the cut panels. Install and nail into J-channel. Install cut panels into trim, avoiding grooves on panels (See Figure 6).

### **Last Course on Wall**

Cut panels to required width. Use snap lock tool to punch tabs in top edge of panel. Cut small pieces of utility trim, Install and nail into J-channel. Install cut panels into trim, avoiding grooves on panels (See Figure 6).

### **INSTALLING ABOVE HORIZONTAL SIDING**

Options for transition include:

- Starter Strip with Drip Cap (see Figure 7).
- Field-formed T-Channel (see Figure 8).
- Lineals (see Figure 9).

*NOTE: When starting with any channel or lineal, a base flashing should be used.*



## NAILING PROCEDURES

- DO NOT NAIL TIGHT
- First, nail through center nail hole - not nail slot.
- If using partial panel, find center of nail hem and drive nail through center of nail hem (not in nail slot).
- Next, nail every 8" through center of four nail slots.
- Last, nail through slot in left tab.

*NOTE: When nailing through slots, always nail center of slot, and DO NOT NAIL TIGHT. Panels must be able to move to allow for expansion and contraction caused by temperature changes.*

### FIRST COURSE

*NOTE: Panels must be installed from right to left.*

- Cut the first Panel at "A" ( See Figure 10).

*NOTE: To Provide for panel movement, allow 1/4" gap at all corner posts, J-Channels, or other stops.*

- Engage bottom lock firmly into starter strip. Nail according to "nailing procedures."
  - Slide the next panel into position. The top half of the panel, except the nail hem, slides under, and the bottom half slides over the previous panel. (See Figure 11)
- NOTE: The amount of panel overlap is important and varies depending on air temperature. Check and monitor air temperature when starting to install the first course on each wall. See Chart for amount of overlap. (See Figure 12).*
- Nail according to "Nailing Procedures."
  - Install additional full panels, repeating steps B-D

### INSTALLATION

#### Last Panel on Each Course

- Measure the distance from the correct line on the temperature gauge into the corner post, less 1/4".
- Cut off left end of panel.
- Engage lock into starter strip or continuous lock of previous course, pull up tight and nail according to "NAILING PROCEDURES."

Installation Tip: Panels will flex to allow installation. To minimize waste, cut

pieces can be used as starter pieces on adjacent wall.

### Using Alignment lines

*NOTE: Temperature gauge is used only for installation of the first course on each wall. Do NOT adjust temperature gauge on panels after 1st course is complete "except when adjusting panels for windows or last panel of each course".*

For 2nd and subsequent courses, align Left Side Flange with nearest Alignment Line that allows proper fit and overlap of shingles. Be sure to cut panel to stagger vertical laps.

### Second Course (and all even courses)

- Round Cut – Measure appropriate distance from the Left Side Flange of panel (allowing for staggered vertical laps) and cut (see Figure 13)
- Round Cut –Align Left Side Flange with nearest Alignment Line of course below that allows for proper fit into corner post or J-channel (see Figure 14).
- Engage lock securely into continuous top lock of course below
- Pull up tight and nail according to "NAILING PROCEDURES".
- Continue installing full panels in the course, following Steps c-d.
- To finish course, refer to the previous section titled "Last Panel on Each Course".

### Third Course (and all odd courses)

- Measure the distance from the first RIGHT Alignment Line "0" of the course below to the edge of the corner post or J channel plus 1/4" (see "A" on Figure 14).
- Engage lock securely into continuous top lock of course below
- Round Cut – Align Left Side Flange with nearest Alignment Line of course below that allows for proper fit into corner post or J-channel (see Figure 15).
- Pull up tight and nail according to "NAILING PROCEDURES."
- Continue installing full panels in the course, following Steps c-e above.
- To finish course, refer to the previous section titled " Last Panel on Each Course" on page 49.



Fig.10

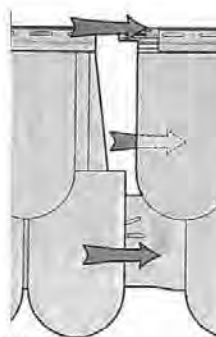

Fig.11

Air Temperature (°F)	10	30	50	70	90
Temperature Max	1/4		1/8		0
Panel Overlap	[Diagram]		[Diagram]		[Diagram]

Fig.12

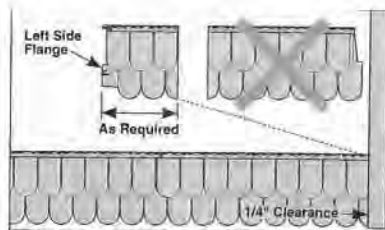

Fig.13

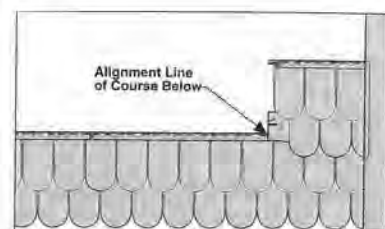

Fig.14

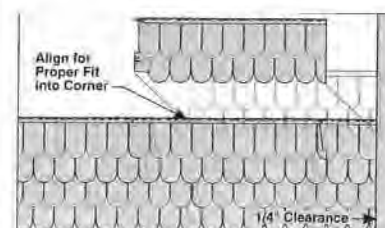

Fig.15



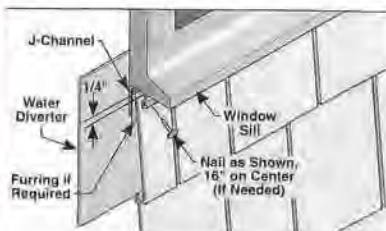

Fig. 16

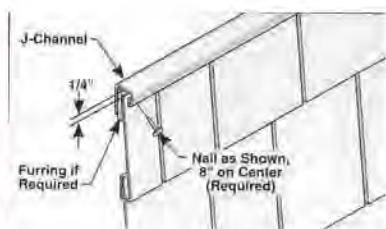

Fig. 17

### Securing Panels Around Windows

- Measure and cut panels around windows, allowing  $\frac{1}{4}$ " into all window channels for movement. (see Figure 16).

- Make sure to install water diverters at the bottom corners of the window (refer to Basic Accessory Installation Section "Installing J-Channel, Flex-J and Flashing").

- Use a nail slot punch to create nail slots every 8" on the cut edge of the panel.

- Furr as needed.

- Slide panel into window channel.

- Pull up tight and nail according to "NAILING PROCEDURES" (window channel must conceal nail-heads).

*Installation Tip: A nail set can be used to ease installation.*

### Installing Final Course

*NOTE: A crown molding, J-channel or wide window casing can be used in eaves and gables to receive the final course (see Figure 17).*

- Measure the required width for last course less  $\frac{1}{4}$ " to allow for panel movement.

- Cut panel height as required.

- Punch nail slots every 8".

- Nail through center of slots.

*NOTE: Furring may also be required.*

## INSTALLATION

### Installing Round Cuts on Gable Ends

Round cuts can be installed directly onto Shingle or Hand Split panels. If desired for transitions, panels can be installed using Starter strip over Drip Cap, or into T-Channel or Lineals. When installing into any channel or lineal, cut 4" from the bottom of the Round Cuts (see Figure 18). Allow 1/4" gap for panel movement.

**NOTE: PANELS MUST BE INSTALLED FROM RIGHT TO LEFT. Do not nail tight. Allow 1/4" into all channels, posts and stops. Make a template for gable angle by locking a short piece of siding into the gable starter course. Hold a second piece against the gable finish trim. Mark angle on first piece and cut (see Figure 19). Make templates as needed.**

### Centering Round Cuts on Gable Ends

When installing Round Cuts in gables, the last piece should be centered at the peak of the gable for proper appearance.

a. For symmetrical appearance at peak, position and lock full panel in the first course with Round Cuts at center of the gable (see Figure 20).

Temporarily fasten through center hole. Continue temporarily installing full panels toward right side of the gable (see chart, Figure 21, for overlap).

b. When less than full panel is needed, measure top of Nail Hem into gable end trim, less 1/4" (see Figure 22). Use this dimension (L) to cut first piece for installation.

c. To locate the cut mark on 1st panel, measure from the appropriate temperature mark to the right and mark top of Nail Hem (see "L" on Figure 23).

d. Use template and cut at mark. If needed for secure installation, move the mark an equal distance (X on Figure 20) from any Alignment Line.

e. Remove temporarily nailed panels.

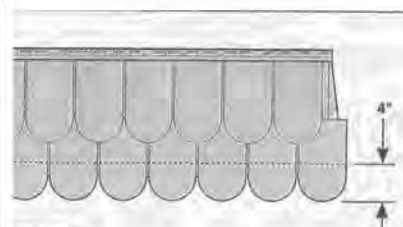

Fig.18

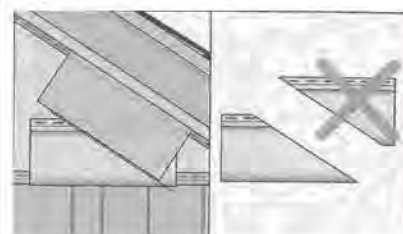

Fig.19

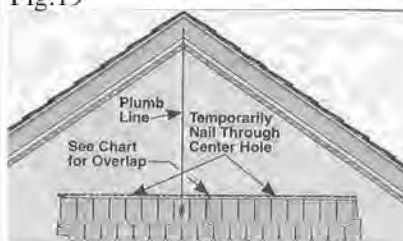

Fig.20

Air Temperature (°F)	10	30	50	70	90
Temperature Min.	1/4	1/8	0		
Panel Overlap					

Fig.21

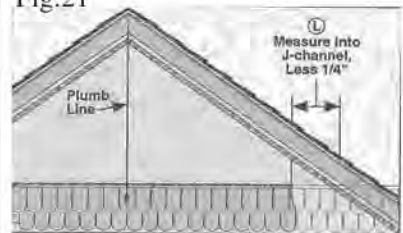

Fig.22

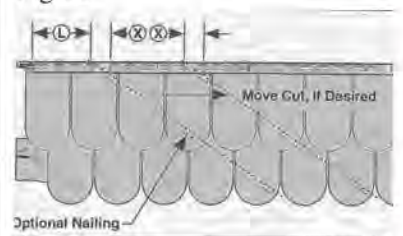

Fig.23

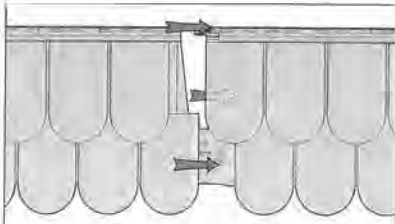

Fig.24

Air Temperature (°F)	10	30	50	70	90
Temperature Mark	1/4	1/8	0		
Panel Overlap	[Diagram]		[Diagram]		[Diagram]

Fig.25

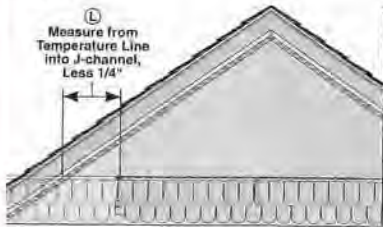

Fig.26

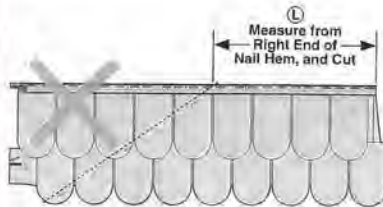

Fig.27

### Installing 1st Course on Gable End

a. Use panel cut in step “d” above. If installing into Siding or Starter Strip, lock firmly, pull up tight and nail according to “NAILING PROCEDURES.”

b. Slide the next panel into position. The top half of the panel, except the Nail Hem, slides under, and the bottom half slides over the previous panel. The Nail Hem will be on top of the previous panel (Figure 24).

Nail slots can be placed at angle cut for additional nailing.

c. If this is your first course of Round Cuts refer to chart for over lap amount (Figure 25).

d. If this is not your first course of Round Cuts, align Left Side Flange with nearest Alignment Line of course below that allows for proper fit into right end finish trim.

e. Engage bottom lock firmly into Siding or Starter Strip, pull up tight and nail according to “NAILING PROCEDURES”.

f. Install additional full panels, repeating Steps c-e.

### Last Panel on Each Course

a. Make template for angle if needed.

b. Measure distance from correct line on temperature gauge into the gable end trim, less 1/4” (see “L” on Figure 26).

c. Measure panel from right end of Nail Hem and cut at correct angle (see “L” on Figure 27).

d. Engage lock into starter strip or continuous lock of previous course, pull up tight and nail according to “NAILING PROCEDURES.”



## 2ND and Subsequent Courses on Gable End

- a. Make new template for angle if needed.
  - b. Measure from the Left Side Flange making sure to stagger the laps by at least 3 round-cuts (Figure 28).
  - c. Align Left Side Flange with nearest Alignment Line of course below (Figure 28).
  - d. Insert Bottom Lock into Top Lock of course below. Pull up tight and nail according to "NAILING PROCEDURES".
  - e. For second and subsequent panels, align Left Side Flange with nearest Alignment Line of course below that allows for proper fit.
- Insert Bottom Lock into Top Lock of course below. Pull up tight and nail according to "NAILING PROCEDURES".

## Final Course on Gable end

- a. Measure width needed at bottom lock (see Figure 29).
- b. Carefully check alignment of Round Cuts to center full or partial rounds as needed and cut (see Figure 30).
- c. Insert Bottom Lock of final course into Top Lock of course below, pull panel up tight, and nail at peak using a color matching trim nail.

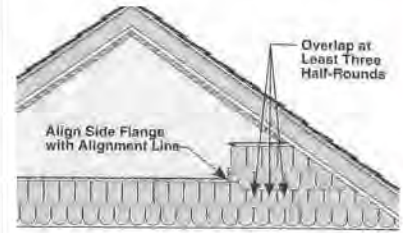

Fig.28

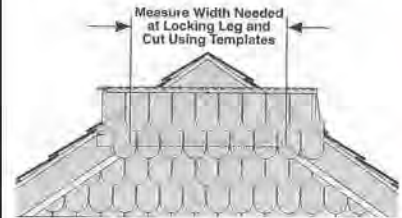

Fig.29

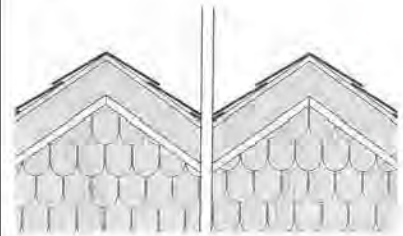

Fig.30

### *Considerations*

Prepare insulated siding material estimates just as you do for conventional vinyl siding installation. Refer to Page 11 for estimation guidelines.

Store siding as you would any other vinyl siding.

**NOTE: Handle open cartons with care so you don't damage the foam backer.**

The bottom lock of the top panel locks into the top of the lower panel. An audible "click" is made when properly installed.

### *Preparing the Walls*

A smooth, flat, stable wall surface is necessary for the proper installation of insulated siding.

Insulated siding should never be applied directly to studs without sheathing.

The underlayment should be securely fastened to the framing members.

Scrape off any loose caulk and any other build up that may interfere with the siding installation.

Although insulated siding panels will help to even out some wall surfaces, underlayment may require some repair to minimize any waves in the wall. In some cases, furring strips may need to be applied to achieve a level wall surface.

**NOTE: For best appearance, it is suggested to use factory ends only. If you must use a non-factory end, it may require the removal of foam and adhesive for lapping.**

***Accessory Installation***

Insulated siding is installed very similar to other siding products, with a few exceptions. Most notable exceptions include the required use of the following accessory trim.

***Starter Strip***

Insulated siding requires the use of a special starter strip designed specifically for this panel. Refer to page 18 for starter strip installation.

In cases where starter strip is not able to be used, secure the panel using utility trim and/or J-channel.

***1 1/8" Insulated Window and Door Surround Lineal***

Refer to pages 25-26 for installing Window Door Surround. Miter cuts may require the foam to be temporarily slid away from the end for cutting. Cut foam to ensure foam to foam contact is made.

***1 1/8" Insulated Outside Corner Posts***

Refer to pages 21 and 22 for installing and splicing outside corner posts.

Splicing the insulated OSCP may require the foam to be temporarily slid away from the end for cutting. Cut foam to ensure foam to foam contact is made.

***1 1/8" Inside Corner Posts***

Refer to pages 21 and 22 for installing and splicing inside corner posts.

***1 1/4" J-Channel***

1-1/4" J-channel should be used around windows, doors and other openings for a receiving channel.





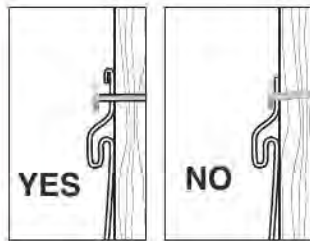

Fig. 1

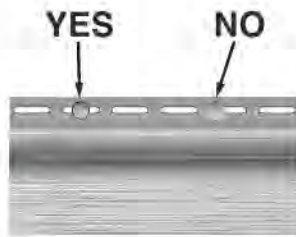

Fig. 2

### ***Installing Insulated Siding***

Insulated Siding Panels are installed similar to typical siding panels.

#### ***Step 1***

The first panel should be placed into the specially designed starter strip and locked along the entire length and subsequent panels installed.

#### ***Step 2***

Fasteners should be placed at a maximum of 16" on center for siding and 8" - 12" for accessories. Fasteners should not be driven tight, allowing for a 1/16" gap between the fastener head and panel for expansion and contraction. Fasteners should penetrate a solid wood surface by at least 3/4". (Fig. 1)

#### ***Step 3***

Always nail in the center of the nail slot and do not fasten panels too tightly to the wall - this allows for expansion and contraction. (Fig. 2)

#### ***Step 4***

Insert the factory or cut end of the siding into the receiving end channels - allowing 1/4" gap over 40f or 3/8" under 40f between panels and receivers for expansion and contraction.

**NOTE: For best appearance, it is suggested to use factory ends only. If you must use a non-factory end, it may require the removal of foam and adhesive for lapping.**

### ***Overlapping Panels***

Typically the foam backer is recessed 3/4" from the end of the panel and the adhesive will begin approximately 1" back from the foam.

Overlap the panels by slipping the panel being overlapped between the panel and foam of the adjoining panel. (Fig. 1)

To correctly overlap the panels, insert the vinyl edge of one panel in between the foam and the vinyl of the adjacent panel. Slide the panels together until the foam ends touch. It is recommended to have a gap of 1/8" during installation under cold weather conditions, i.e., 40 degrees Fahrenheit or 4.4 degrees Celsius.

Insulated siding panels should be overlapped 1-1/4" to 1-1/2". (Fig. 2)

### ***Over & Under Windows and Doors***

Windows, doors, corners, and other openings should be properly flashed according to manufacturer's recommendations.

In some cases, on openings up to 36", the foam back on the panel will create sufficient stiffness to span under or over a window without additional accessories.

In cases where additional support is needed, and when the insulated siding panel must be cut to fit under or over a window, a snap lock punch can be used to secure the panel into a utility trim or dual undersill trim. (Fig. 3) - Snap lock punches should be raised every 6". Foam backing may have to be removed in order to accommodate shimmed utility or dual undersill trim.

**NOTE: Removal of panel foam and the use of shims or furrings may be necessary.**

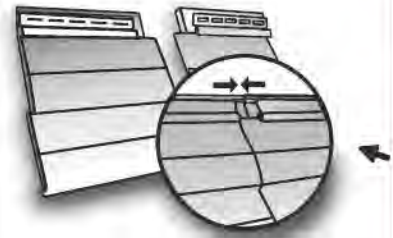

Fig. 1

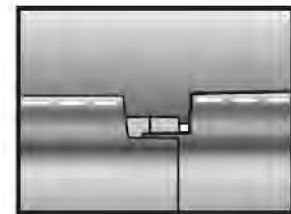

Fig. 2

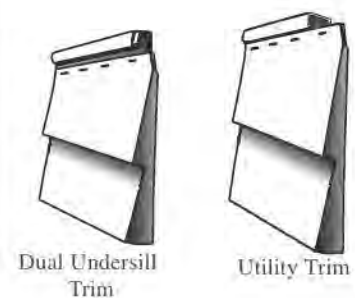

Fig. 3



### *Finishing at the Top*

#### *Step 1*

The last course of the insulated siding panels can be secured by using shimmed utility trim or dual undersill trim. Snap lock punches should be raised every 6". Foam backing may have to be removed in order to accommodate shimmed utility trim or dual undersill trim.

#### *Step 2*

A nail slot punch may be used in order to create additional slots in the vinyl siding to secure the panels. Slots should be no more than 16" apart and installed to allow for proper expansion and contraction. Be certain any fasteners will be covered by the receiving channel or other trim.

Removal of panel foam and the use of shims or furring strips may be necessary.

**IMPORTANT:** Slide foam backer out of the area to be cut on an accessory piece to prevent any foam particles from getting lodged in to lock.

**NOTE:** Make certain no foam particles are in the top or bottom lock of any panels being installed.



***Additional Notes:***

Due to the thickness of the insulated siding products - windows, doors and other areas may need to be built out or properly shimmed to avoid a recessed appearance.

For proper appearance, all accessories used with insulated siding panels should be installed to ensure proper interfacing of accessories and panels. Ensure that the accessories are on the same plane and able to accommodate the panels.

Cutting the insulated siding panel is similar to that of cutting standard vinyl siding panels and accessories. A hand held circular saw with the blade installed backwards usually offers the smoothest, cleanest cut of the panel and foam backing.

For easier cutting of accessories, it may be necessary to slide the foam out of the way. Score or pre-cut the foam with a utility knife in order to get the cleanest cut.

When historic restoration projects arise, the manufacturer recommends the following:

### ***Step 1***

If a building is in a historic area, local Historic District or has been designated as a historic building, make sure that approval for the use of vinyl siding has been obtained from the local historic society or local Historic District Commission. This applies to building additions as well.

### ***Step 2***

Before a historic building is resided, it should be examined for moisture, insect infestation, structural defects, and other problems that may be present. These problems should be addressed and the building pronounced “sound” before residing with any material.

### ***Step 3***

Do not damage or remove the original siding. If at all possible, do not alter the original structure, so that the application of vinyl siding is reversible (i.e., the original siding would remain intact in the future, so that if desired, the vinyl siding could be removed). Exception: “In cases where a non-historic artificial siding has been applied to the building, the removal of such a siding before application of vinyl siding would, in most cases, be acceptable”.

1Preservation Briefs, Number 8, U.S. Department of Interior, 1984.1

### ***Step 4***

Exercise every care to retain architectural details wherever possible. Do not remove, cover, or add details until the building owner’s written approval has been obtained. Determine that the owner has consulted the local historic society for approval.

### ***Step 5***

Use siding that closely approximates the appearance of the original siding in color, size and style. In historic districts, the goal is to match the product as closely as possible and retain the original trim.

*For further information, contact:  
Historic Preservation at [www2.cr.nps.gov](http://www2.cr.nps.gov)*

Vinyl siding can be successfully installed in a diagonal position by slightly modifying the basic installation concepts. This particular look is generally referred to as a herringbone pattern. This application technique merges the methods of installing horizontal and vertical siding.

### Step 1

The area to be sided should be trimmed out as in the same manner as installing vertical siding. The appropriate accessories should be installed at the wall ends, and J-Channel installed along the bottom of the wall section and the eave (roofline), if necessary. If the desired look of the gable is for the siding to meet in the middle, divide the wall from the peak vertically, with a piece of H-Mold or two J-Channels back-to-back. Proper flashing, insulation and/or protective wrap should be utilized as needed to protect the sub-wall from possible moisture penetration (Fig. 1).

### Step 2

For gable end applications where the siding meets in the middle of a gable, installation should begin on the lower, center of the wall where the vertical J-Channel meets the horizontal J-Channel. Next, determine the angle of the siding to be installed. This angle is determined by aesthetics, but typically matches the angle of the eave. This angle should not exceed 45°. Cut one piece of siding for each lower, center corner, matching the desired angle as shown in Figure 2.

*NOTE: The use of patterns will speed-up cutting and installation time. These patterns may be created in a similar fashion to those used for gable cuts in the section on the horizontal application. Simply place the horizontal piece on top of the piece that matches the angle of the eave rather than beneath. Mark a line across the diagonal piece where the two panels meet. This will give you the angle of the cut. Repeating the technique for the opposite end of the panel using a vertical piece of siding rather than a horizontal one will give you the opposing angle.*

### Step 3

Since the siding panels are being installed on an angle, the nailing methods for vertical siding should be followed. Center the panel allowing proper clearance on both ends. In the first full nail slot on the uphill side of a panel, place a nail at the top of the nail slot to keep the panel from sliding downward (see Fig. 2, detail C). This allows for proper expansion in both directions. Fasten the remainder of the panel in the center of the nailing slots following standard installation rules. Repeat with remaining panels, making sure the panels are fully locked together.

Do not allow the first panel to rest in the horizontal J-Channel, as this will alter the angle of the panel and prohibit proper expansion.

### Step 4

On gables where the siding angle matches the eave (roofline), a piece of undersill trim can be installed inside the eave J-Channel to receive and secure the last course of siding. Cut, snap-lock and lock the panel into the undersill trim as shown in Figure 3.

*NOTE: For Rectangular Wall Application (Follow Steps 1-3 and see note below). On rectangular wall sections, the last piece of siding may be a relatively small triangular piece. It may be necessary to fasten the last piece in place by using a trim nail near the top corner.*

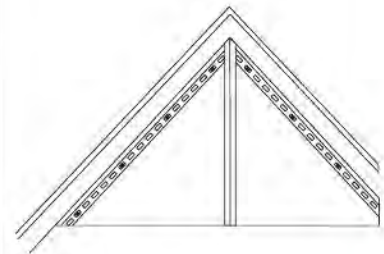

Fig. 1

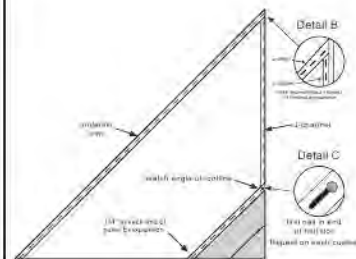

Fig. 2

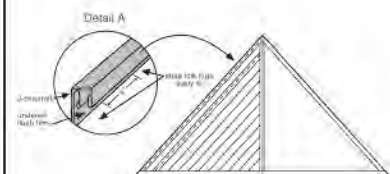

Fig. 3



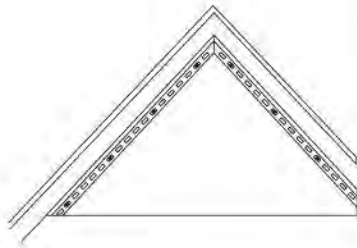

Fig. 1

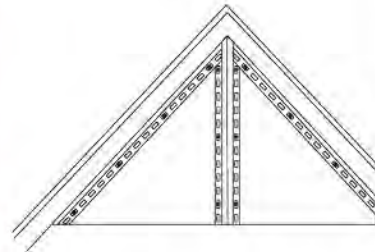

Fig. 2

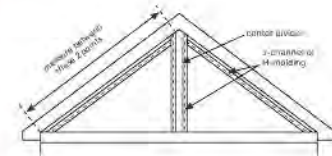

Fig. 3

*Note: The following instructions outline general methods for installing vinyl siding in a sunburst pattern. There are a variety of factors that will affect a sunburst installation such as the placement of round top windows, unique angles and dimensions. You must adapt these instructions to your specific installation.*

*Materials needed are J-channel (H-molding can be used for the center divider), starter strip, trim, coil and siding. Wider faced siding panels will install faster than narrow panels due to the unique methods employed in constructing a sunburst. Traditional style lap panels are the best profile choice. Decorative panels, such as Dutchlap profiles, are impractical for this application. You will only be using the lower half of double-faced panels (e.g. D4, D5) in this application. Single faced panels can be used full width if desired.*

*Tools needed in addition to standard installation tools are a nail hole punch and pop rivet gun. The following instructions assume an installation at a gable end of a building.*

### **Installation Steps:**

#### **Step 1**

Install J-channels in gable along eave line. (See Figure 1) Soffit (if used) should already be installed.

#### **Step 2**

Plumb back-to-back J-channels or H-molding in the center of the gable (see Figure 2).

*NOTE: Bottom of J-channel or H-mold will be trimmed depending on the wall configuration. A sunburst can transition (a) non-stop from horizontal siding, (b) around a round top window, or (c) from a divider trim board.*

#### **Step 3**

The following step explains how to determine the spacing of the panels along the gable angle so all panels are evenly spaced. Measure from the lower gable corner to the peak of the gable (see Figure 3). Divide this measurement by the width of the lower half of the panel being used (e.g. D4 panels divide by 4", D5 panels divide by 5", etc.).

#### *EXAMPLE:*

*169 inches along the rake = 33.8 panel sections 5" (D5 panel)*

Round up the number of panel sections determined to at least the next highest even number (33.8 to at least 34). In this example we chose **35** because it gives additional coverage at the gable rake end of the cut panels.

#### *EXAMPLE:*

*169 inches along the rake = 4.83" spacing between each panel section 35*

**Step 4**

Measure from inside the channel of the center divider to either lower gable corner (see Figure 4). **Cut a:** Cut a panel to this length less 1/4" at each end to allow for expansion. When installing in temperatures below 40°F, increase the clearance to 3/8". **Cut B:** Carefully cut the panel lengthwise with a utility knife just below the center butt. Set the upper section aside. **Cut C:** Cut the end of the panel that meets the gable rake to an angle that matches the roof pitch.

*NOTE: Some installers use the nail hem removed from the upper discarded panel section as the starter strip between panel sections. This is acceptable providing it is carefully trimmed so the cut edge does not show. We did not utilize this method since it is difficult to make this cut safely and accurately.*

**Step 5**

This step allows you to cut the panels to make the flare for the sunburst. Chalk or scribe a reference line between the two marks (see Figure 5.) This represents the exposed face of the panel once the sunburst is completed. Measure 1" above this reference line, scribe a new line, and cut the panel discarding the upper section.

**Step 6**

Punch nail holes in the top edge of the panel with a nail slot punch every 12" to 16". All punches should be above the lower line (see Figure 6). Fasten the panel to the wall according to the nailing instructions stated earlier in this manual.

**Step 7**

Position a starter strip to where the bottom of the starter is along the lower line of the installed panel. You will attach the next panel to this starter strip. When properly positioned, the starter strip will fasten to the wall above the top edge of the previous panel, and extend over it to cover the nail heads (see Figure 7). This method will allow the siding panels to properly expand and contract during temperature changes.

It is recommended that you choose a starter strip design that does not show after the next panel is installed. The starter strip can be vinyl or metal.

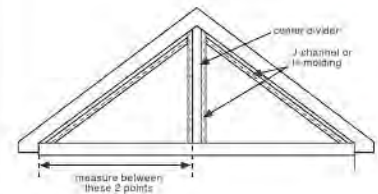

Fig. 4

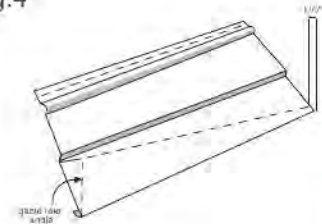

Fig. 5

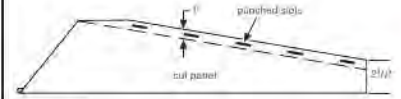

Fig. 6

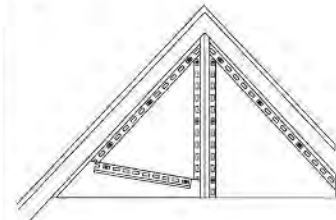

Fig. 7

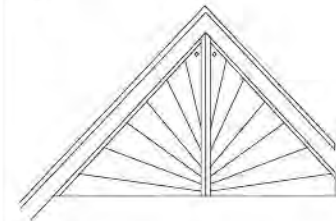

Fig. 8

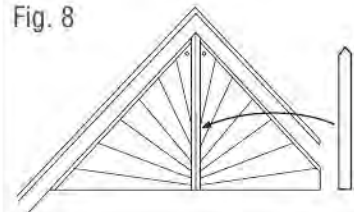

Fig. 9

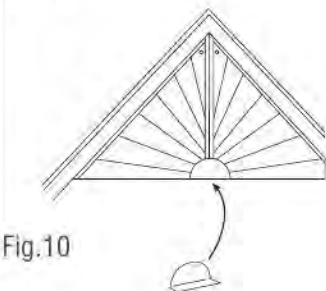

Fig. 10















## SELECTION, QUALITY & ASSURANCE.

Enjoy peace of mind when you choose Georgia-Pacific® Vinyl Siding and Accessories. Engineered and manufactured to meet or exceed rigorous industry standards (ASTM D 3679), Georgia-Pacific® Vinyl Siding is backed by a Limited Lifetime Transferable Warranty.\*

Distributed by



[www.bluelinxco.com](http://www.bluelinxco.com)

BlueLinX Corporation  
4300 Wildwood Parkway  
Atlanta, Georgia 30339  
1-888-502-BLUE  
1-800-839-2588 (Eastern Sales Region)  
1-800-830-7370 (Western Sales Region)

V I N Y L   S I D I N G   S O F F I T   S K I R T I N G   S H U T T E R S   I N S T A L L A T I O N   C O M P O N E N T S

Georgia-Pacific, GP, and the GP logo are registered trademarks owned by Georgia-Pacific LLC and are used under license. BLUELINX and the BLUELINX design are trademarks and registered service marks of BlueLinX Services Inc.

©2014 BlueLinX Corporation. All rights reserved. Printed in the U.S.A. 4101099991110 ERM/FRD/4.14/1.35k

\* For complete warranty details, call 1-800-502-BLUE.