

PARTY TENT

Product ID. Q7XCD

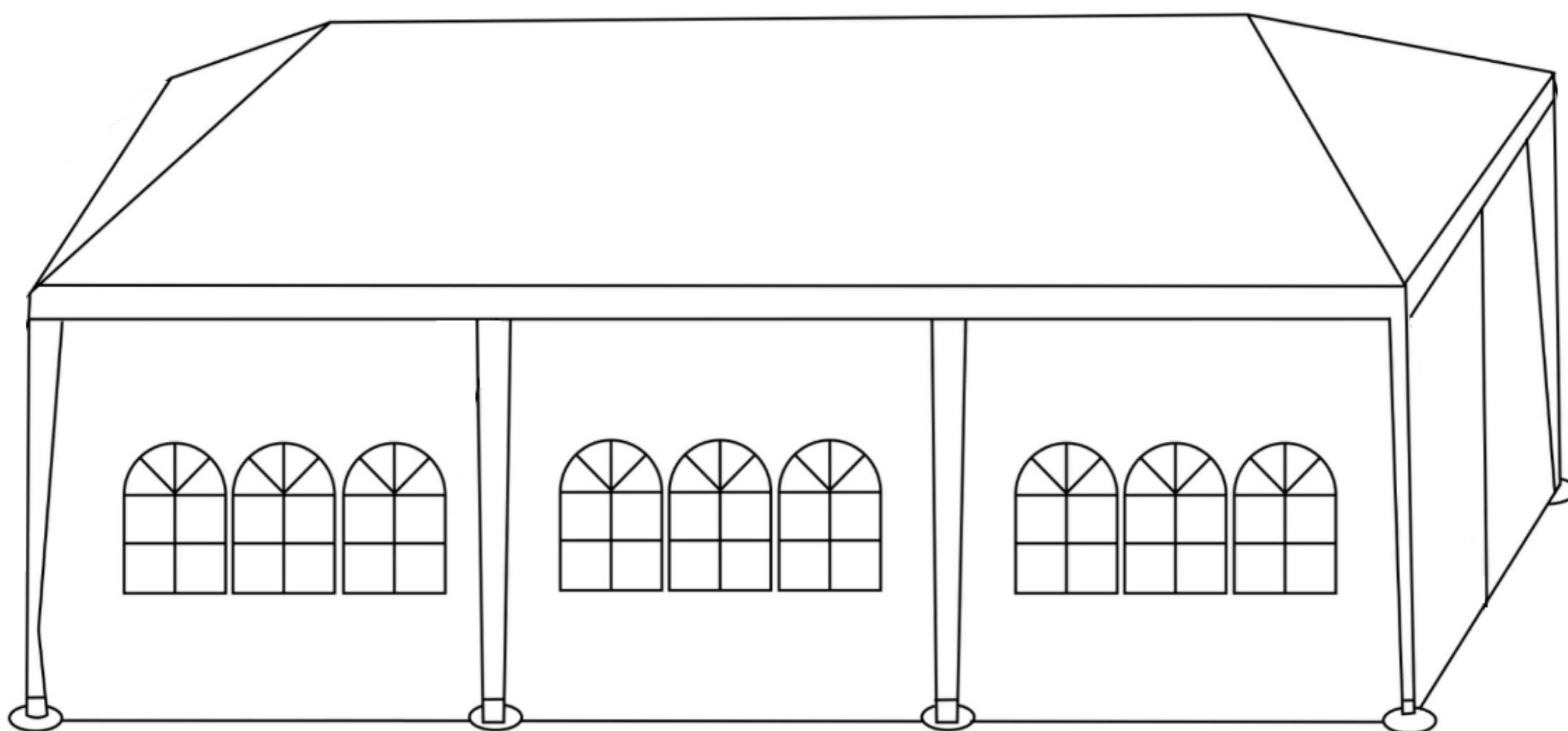

Scan for Support
support@garvee.com













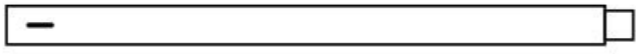
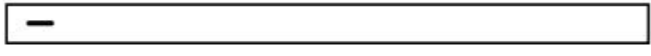
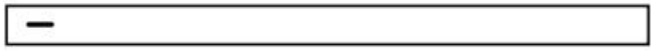
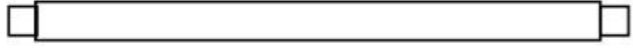
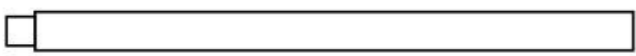

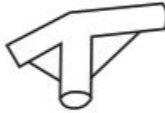

Distributed by
GARVEE.com

V251225SBW3

3x9M instruction manual

Parts List

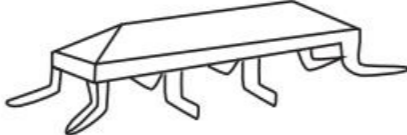
You'll receive only one (1) box. Please pay particular attention to making sure all parts are numbered and graphically indexed as shown, so does the quantity for each part. If you need any help, please contact us promptly.

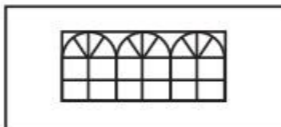
Part Number	Diagram	Description	Quantity (PCS)
#1		Top Pole With Male End	4
#2		Top Pole With Female End	10
#3		Horizontal Pole With Female End	16
#4		Horizontal Pole With Male End	8
#5		Leg Pole With Male End	8
#6		Leg Pole With Female End	8
#7		Top Horizontal Pole With Male End	1
#10		Top Mid-Pole With Male End	4
#8		Top Horizontal Pole With Female End	3
#A		End-4 Way Corner Connector	4
#B		Mid-4 Way Corner Connector	4
#C		3-Way Corner Connector	2
#D		Top-4 Way Corner Connector	2
#E		Foot Base	8
#F		21mm Pole Sleeve	13
#G		28mm Pole Sleeve	16
#H		Rope	8
#I		L-Shaped Peg	16
#J		Roof Cover	1
#K		Zipper Door	2
#L		Sidewall with Window	6

Step 1. Assemble the top frame with the poles (16 x #3 & 8 x #4) and the connectors (4 x #A & 4 x #B). Please also add the Pole Sleeves (#G) to the joints of the poles (#3 & #4).

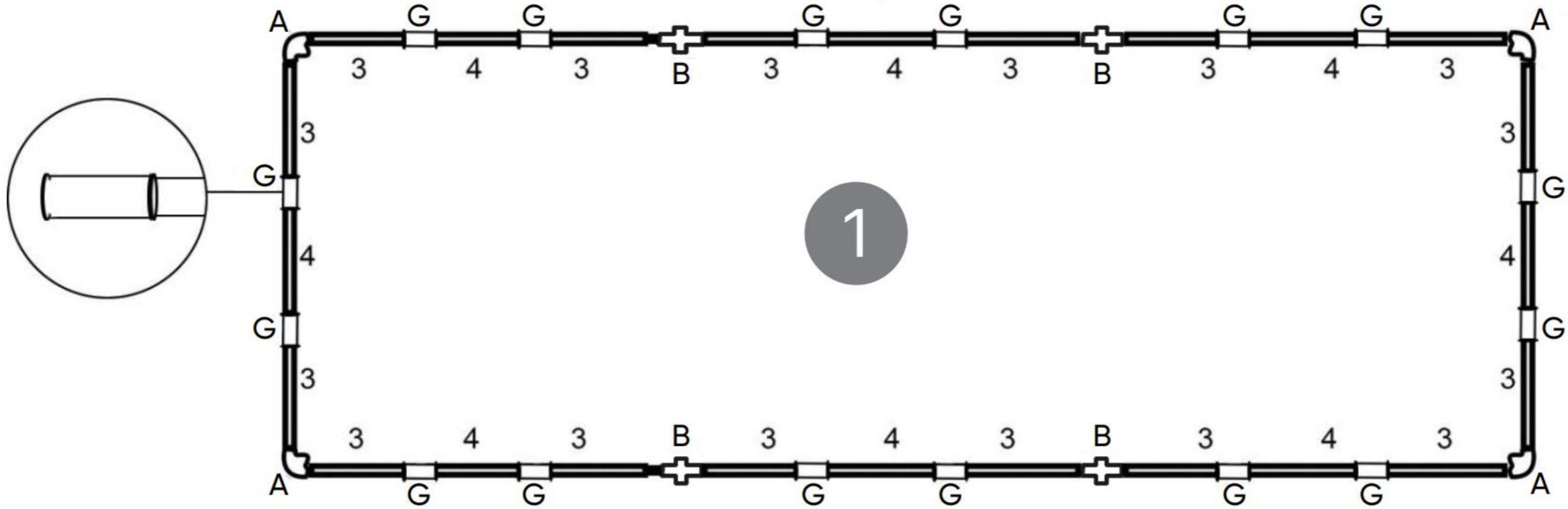

Step 2. Assemble the roof frame and the mainframe.

- You'll use poles of 4 x #1, 10 x #2, 1 x #7, 4 x #10, 3 x #8 and Connector of 2 x #C, 2 x #D for the roof frame.
- Connect 8 x poles (#5) with the connectors (#A & #B) on the top frame.
- Please remember to add the Pole Sleeves (#F) to the joints of the poles (#1, #2, #7, #10 and #8).

⚠ Important

Top 1 x #7 and 1 x #8 needs to go through #D.

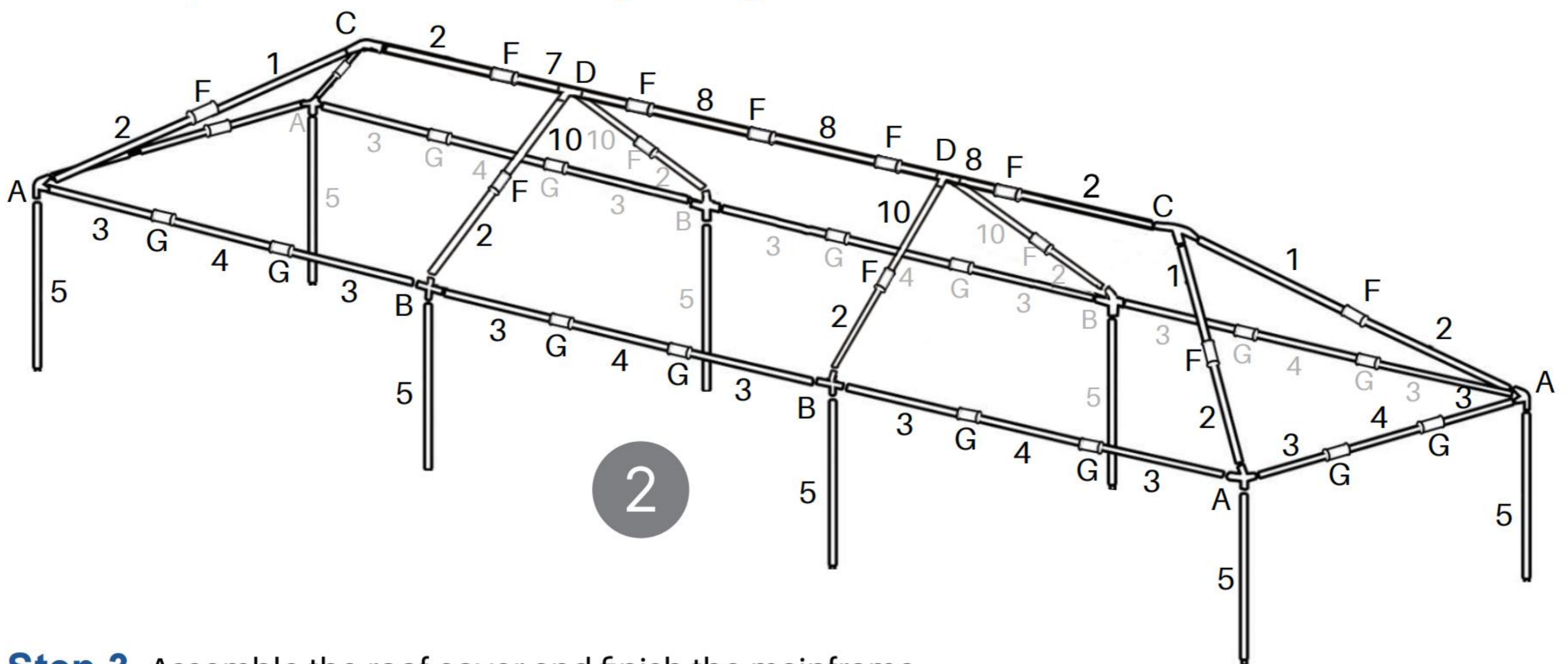

Step 3. Assemble the roof cover and finish the mainframe.

- Put the Roof Cover (#J) on the assembled roof frame.
- Connect 8 x poles (#6) to the poles (#5).
- Finally, assemble 8 x Foot Bases (#E) to the end of poles (#6).

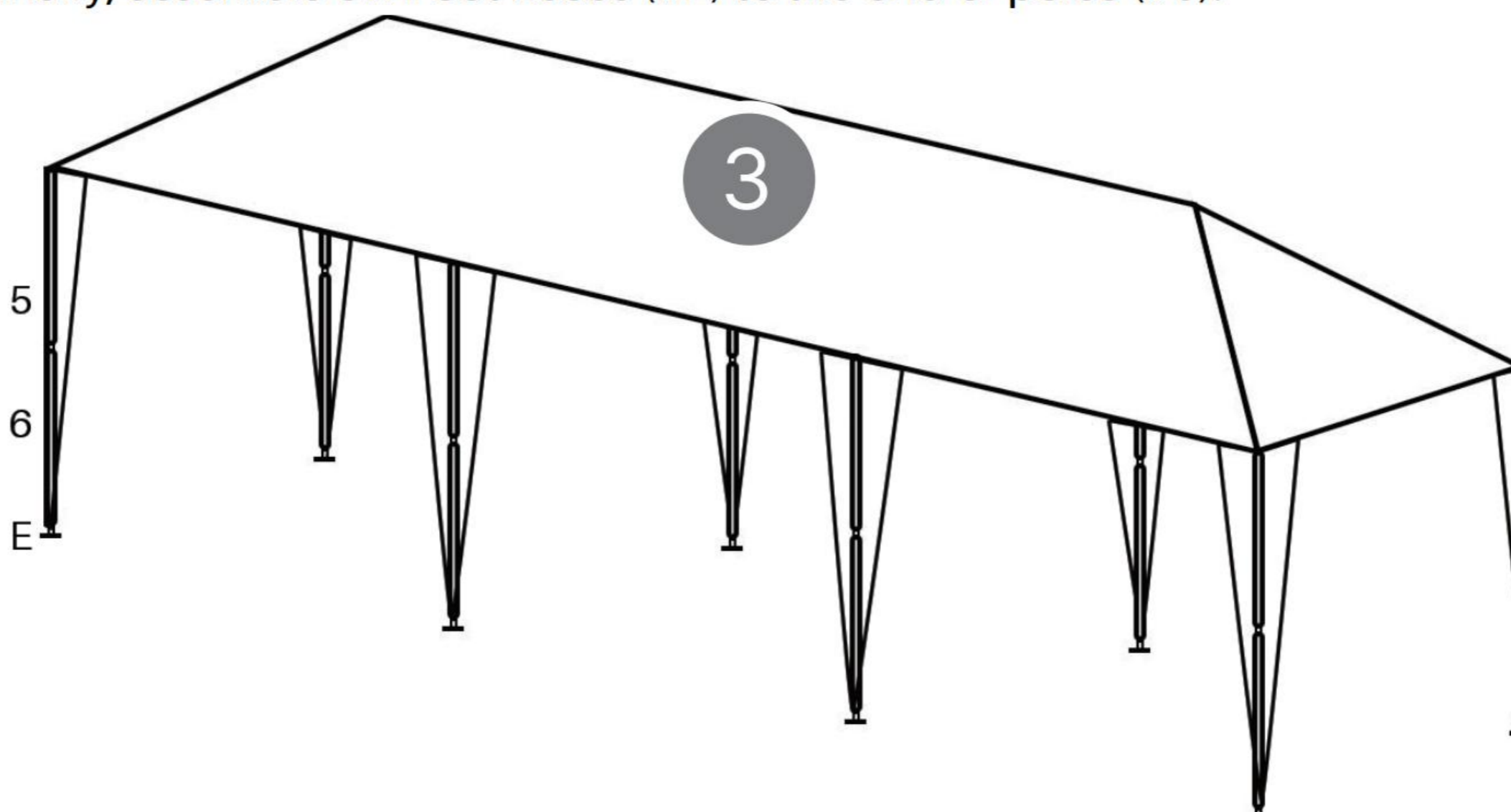

Step 4. Tighten/Loosen the leg cover by placing the built-in hooks into a proper adjusting hole (on poles #6), then secure the whole structure with Ropes (#H) and L-Shaped Stakes (#I).

⚠ Important

When inserting the stakes, we highly recommend you form an angle with the ground (best at the 45-degree).

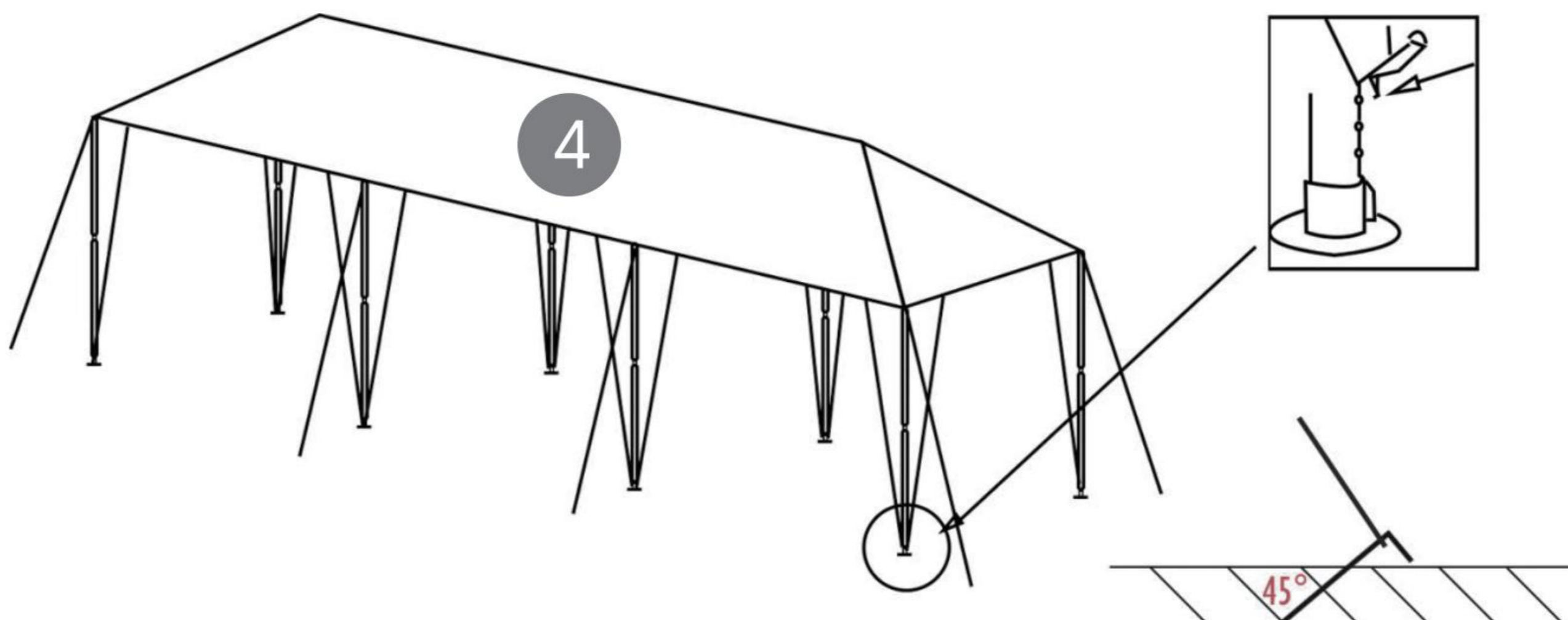

Step 5. Attach the 6 x Sidewalls with Window (#L) and the 2 x Zipper Doors (#K) to the frame with Velcro(built-in)

⚠ Reminder

You can decide to attach how many pieces of sidewalls and doors as per your needs.

