

### Features

- A single handle controls both on/off activation and temperature setting
- 1.0 gpm (3.8 lpm) maximum flow rate at 60 psi (4.14 bar)
- KOHLER® ceramic disc valves exceed industry longevity standards for a lifetime of durable performance
- Metal pop-up drain with lift rod and tailpiece
- Coordinates with other products in the Parallel collection

### Material

- Premium metal construction for durability and reliability
- KOHLER finishes resist corrosion and tarnishing

### Installation

- Single hole
- Preattached flexible supply lines simplify installation

### Recommended Products/Accessories

K-23726 Drain treatment



### Codes/Standards

ASME A112.18.1/CSA B125.1  
NSF/ANSI/CAN 61  
NSF/ANSI/CAN 372  
DOE - Energy Policy Act 1992  
EPA WaterSense®  
California Energy Commission (CEC)  
ADA  
ICC/ANSI A117.1  
CSA B651  
OBC

### KOHLER® Faucet Lifetime Limited Warranty

See website for detailed warranty information.

### Available Colors/Finishes

*Color tiles intended for reference only.*

Color	Code	Description
	CP	Polished Chrome
	SN	Vibrant® Polished Nickel
	BN	Vibrant® Brushed Nickel
	BV	Vibrant® Brushed Bronze
	BL	Matte Black
	2MB	Vibrant® Brushed Moderne Brass
	TT	Vibrant Titanium

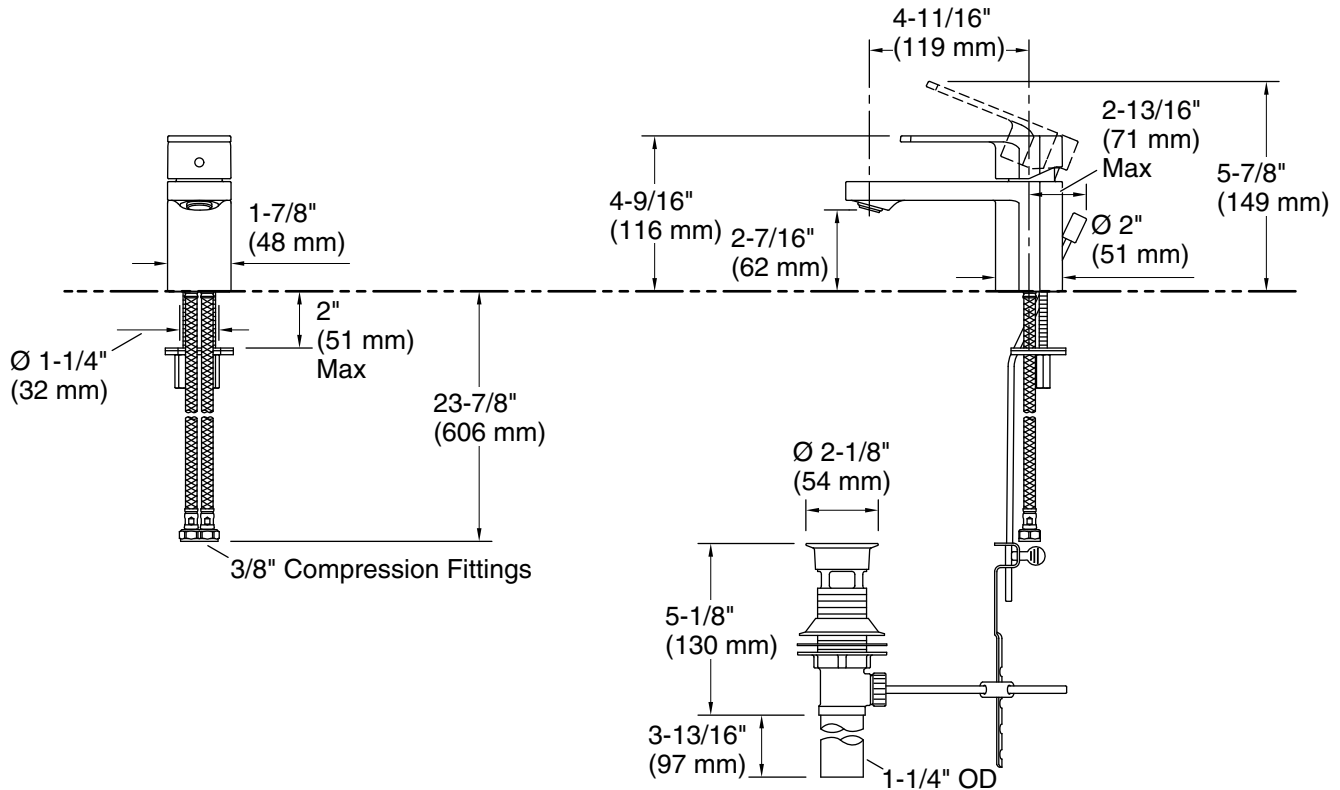

### Technical Information

All product dimensions are nominal.

Faucet flow rate: 1 gal/min (3.8 l/min)

Drain included: Yes

Drain tailpiece included: Yes

### Spout:

Spout reach: 2-11/16" (119 mm)

### Notes

Install this product according to the installation instructions.

ADA compliant for handles only.

ADA, OBC, CSA B651 compliant when installed to the specific requirements of these regulations.