

Ceiling Fan

Installation Manual



OUTDOOR



IP66

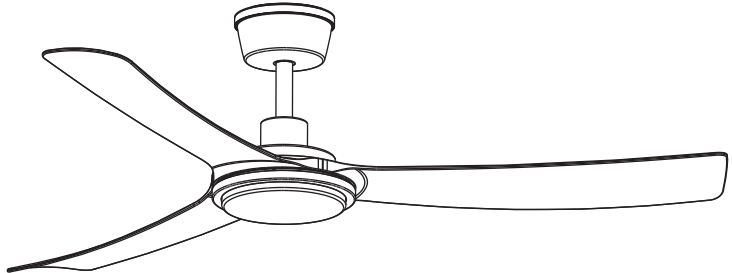
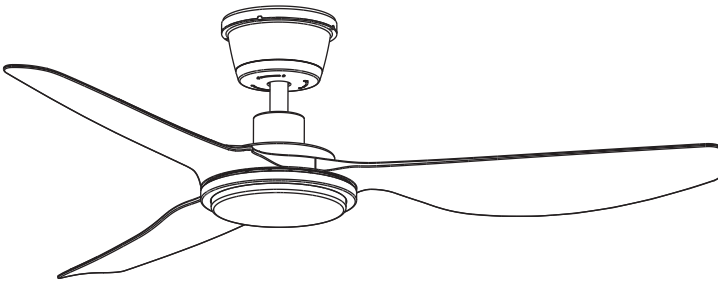



THANK YOU

We appreciate the trust and confidence you have placed in us through the purchase of this ceiling fan. We strive to continually create quality products designed to enhance your home. Thank you for choosing us!

Visit www.pmwfan.com for further assistance.

SAFETY INFORMATION

- 

The fan can only operate properly with all blades installed. If the fan is started without blades, it will beep and automatically shut off.
- 

If you are unfamiliar with electrical installations, please consult or hire a qualified electrician.
- 

Before operating any electrical connections of the fan, be sure to disconnect the main power by removing the fuse or turning off the circuit breaker.
- 

Do not use the fan with a dimmer switch or a speed controller together, as it may damage the fan. It should only be operated using its own built-in speed settings.
- 

The mounting point for the fan must be capable of supporting at least 77 pounds (35kg). If installing on a ceiling outlet box, use the mounting screws provided. Most outlet boxes typically used for installing lighting fixtures cannot be used for installing fans and may need to be replaced. If in doubt, please consult a licensed electrician.
- Ensure the fan's electrical connections are properly grounded to prevent any electrical hazards.
- When deciding where to mount the fan, please ensure that there is at least 30 inches (76 cm) of space between the fan and any walls or other obstacles that its blades might hit. The greater this distance, the more effective the airflow generated will be. After installing, please ensure that the blades are at least 7.5 feet (2.3 meters) above the ground.
- When complete, check that all screws and fasteners are tightened to avoid noise from loose parts.
- Before changing the direction of rotation, ensure that the fan has completely come to a stop to avoid further damaging the motor.
- Fan fasteners can loosen over time. Inspect the key components of the fan, such as the connections of blades, screws, and bracket, at least once a year to ensure everything remains secure.
- If the fan experiences abnormal rotation or vibration, please stop using it and contact the manufacturer or a professional.
- Turn off the fan before cleaning. Please use dry cloth or slightly wet one instead of using water or cleaning agent.

Note: The important warnings and instructions outlined in this manual do not guarantee coverage of all possible scenarios that may occur.

WARNING: Changes or modifications to this unit not expressly approved by the party responsible for compliance could void the user's authority to operate the equipment.

NOTE: This equipment has been tested and found to comply with the limits for a Class B digital device, pursuant to Part 15 of the FCC Rules. These limits are designed to provide reasonable protection against harmful interference in a residential installation. This equipment generates, uses and can radiate radio frequency energy and, if not installed and used in accordance with the instructions, may cause harmful interference to radio communications.

However, there is no guarantee that interference will not occur in a particular installation. If this equipment does cause harmful interference to radio or television reception, which can be determined by turning the equipment off and on, the user is encouraged to try to correct the interference by one or more of the following measures:

- Reorient or relocate the receiving antenna.
- Increase the separation between the equipment and receiver.
- Connect the equipment into an outlet on a circuit different from that to which the receiver is connected.
- Consult the dealer or an experienced radio/TV technician for help.

Battery Safety Tips:

1. Please keep the battery out of the reach of children. Swallowing it can cause severe injury within 2 hours, including chemical burns or death. If ingested, seek medical attention immediately.
2. If the battery is misused or damaged, flammable liquid may leak from it. You should avoid contact with this liquid. If accidental contact occurs, rinse with contact with the eyes, seek medical attention immediately. The liquid emitted from the battery can cause irritation or burns.
3. Do not expose the device or battery to excessive temperatures.
4. Be aware of the risk of short-circuiting the terminals of battery-powered devices or batteries with metallic objects.
5. Do not use modified or damaged batteries.
6. Non-rechargeable batteries should not be charged.
7. Do not mix different types of batteries or new and old batteries.
8. Batteries should be inserted with the correct polarities.
9. Depleted batteries must be removed from the device and disposed of safely.
10. If the device is to be stored for a long period without use, batteries should be removed.
11. Battery: AAA 1.5V

CHECK THE ROOM DIMENSIONS

- First, check the room size, and then ensure there is at least 30 inches (76 centimeters) of clearance or space between the fan and any walls or other obstacles that the fan blades might hit to optimize airflow. After installation, please verify blades are at least 7.5 feet (2.3 meters) above the ground. It can also be installed on inclined roofs with a maximum slope of 15°.

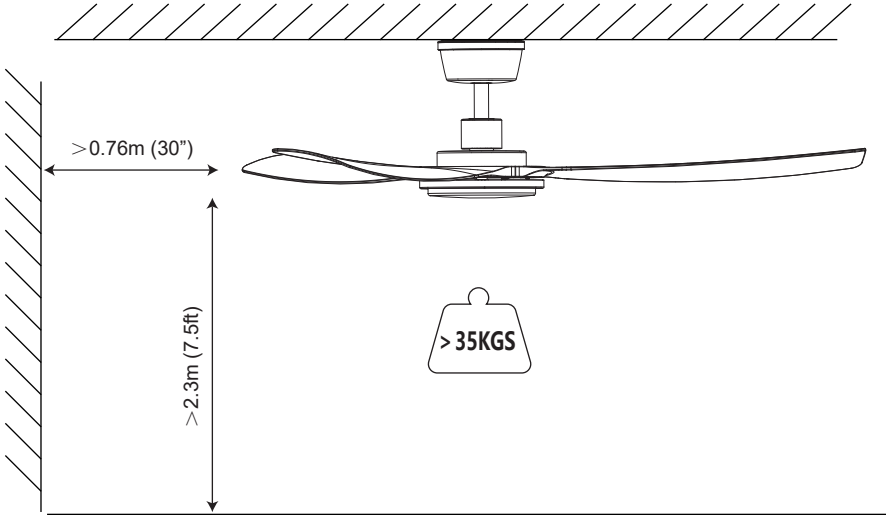

TOOLS NEEDED



Step
ladder



pliers

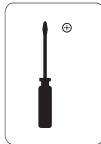

Phillips
screwdriver

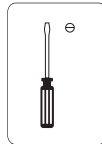

Flat blade
screwdriver



Electrical
tape



tape
measure

PACKING LIST



Before unpacking the fan, please check that all parts are included, as listed below:

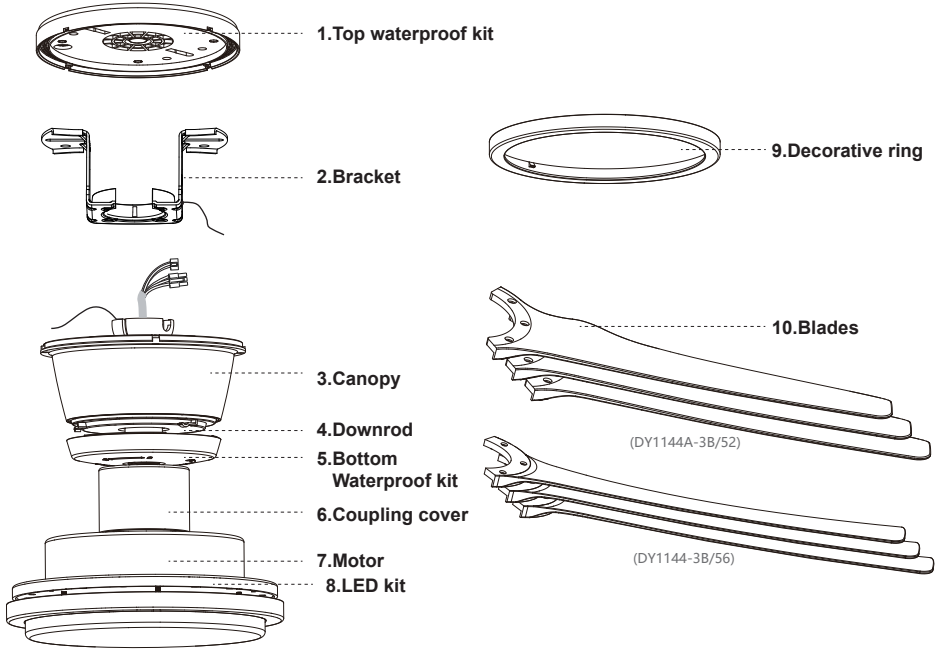

Remote control unit

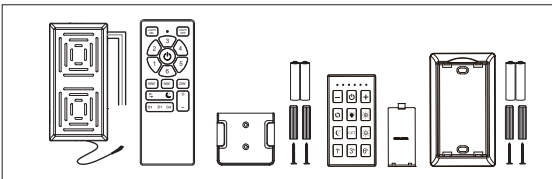

Blade balance kit

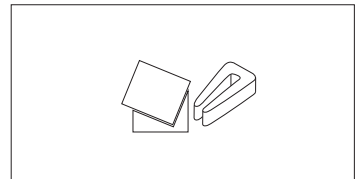

Hardware bag

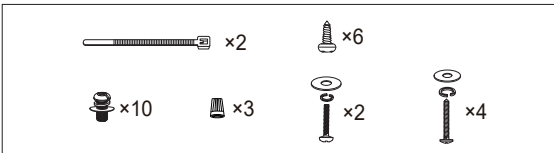

Installation manual

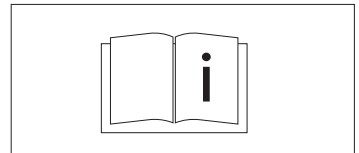

• Note: The illustrations in this manual are for explanatory purposes only and may not correspond to actual units.

Ceiling Fan

Questions, problems, missing parts? Before returning to the store,
visit www.pmwfan.com for further assistance.

Retain this manual for future use.

Manufacturer: Zhongshan Miaowang Electrical Appliance Co., Ltd.

Address: Building C, No.10, Qingfu Road, Henglan Town, Zhongshan City, Guangdong Province,CN

Website: www.pmwfan.com

Tech Support Telephone: +12092272409

Tech Support Email Address: support@pmwfan.com