

# ASSEMBLY INSTRUCTIONS

## LOFT BED

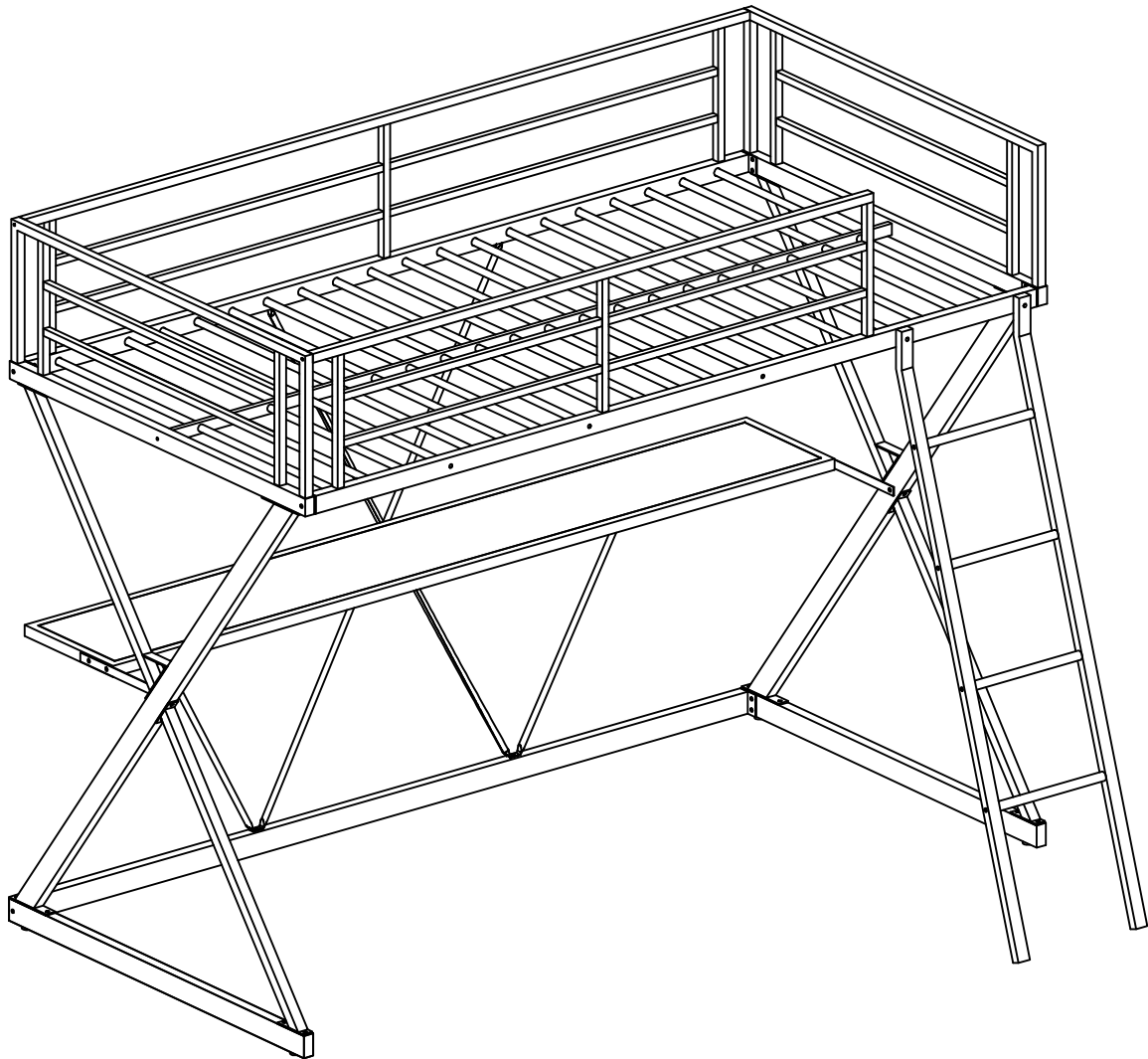

If you have any questions, please feel free to contact us.

Email: [service@qualfurn.net](mailto:service@qualfurn.net)

WF306851

## **SAFETY WARNINGS AND GENERAL NOTES:**

1. Follow the information on the warnings on the upper bunk bed end structure and on the carton. Do not remove the warning label from the bed.
2. Always use the recommended size mattress or mattress support, or both, to help prevent the likelihood of entrapment or falls.
3. Do not allow children under 6 years of age to use the upper bunk.
4. Periodically check and ensure the guardrail, ladder and other components are in their proper position, free from damage, and all connectors are tight.
5. Do not allow horseplay on or under beds.
6. Always prohibit jumping on the bed.
7. Prohibit more than one person on upper bunk.
8. Always use the ladder for entering and leaving the upper bunk.
9. Do not use substitute parts. Contact the manufacturer or dealer for replacement parts.
10. Use of a night light may provide added safety precaution for a child using the upper bunk.
11. Always use guardrails on both long sides of the upper bunk.
12. If the bunk bed will be placed next to a wall, the guardrail that runs the full length of the bed should be placed against the wall to prevent entrapment between the bed and the wall. The use of water or sleep flotation mattresses is prohibited.
13. **STRANGULATION HAZARD**-Never attach or hang items to any part of the bunk bed that are not designed for use with the bed; for example, but not limited to, hooks, belts and jump ropes.
14. Keep these instructions for future reference.
15. We recommend assembling your bunk bed on the shipping carton to protect your floor or carpet.
16. Be certain all staples are out of the box before beginning assembly on the shipping carton.
17. **USE ONLY MATTRESSES WHICH ARE AS THE TABLE BELOW ON UPPER AND ON LOWER BUNKS.**

Upper bed(bunk bed and tribed included)

Bed type	Length	Width	Thickness
Twin Standard	74-75"	38-1/2"	6" max



18. **SURFACE OF MATTRESS MUST BE AT LEAST 5" (127MM) BELOW THE UPPER EDGE OF GUARDRAILS.**

19. Replacement Parts:

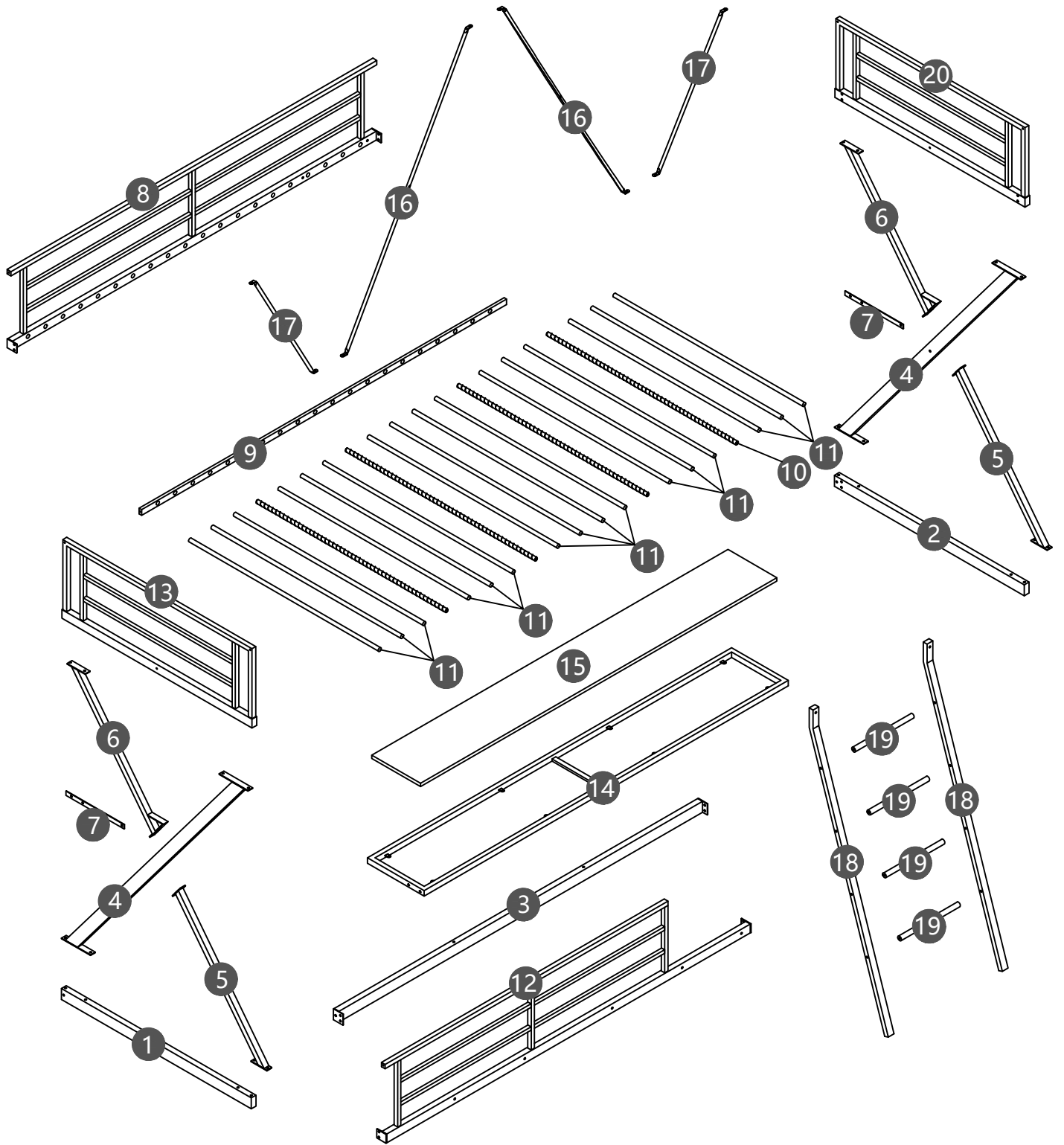



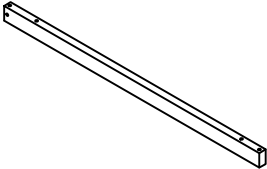
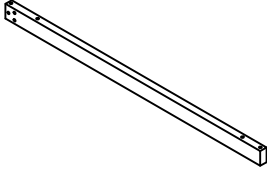
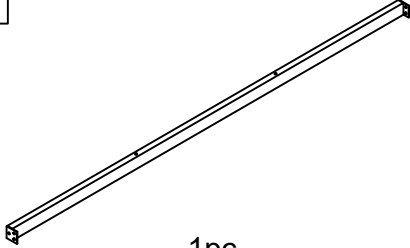
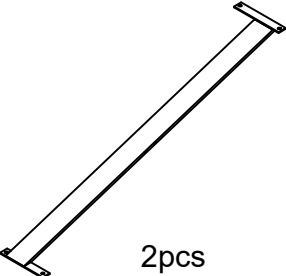
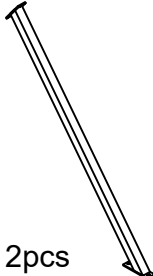
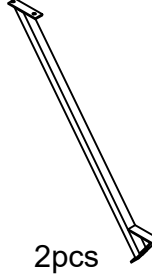
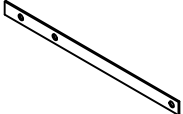
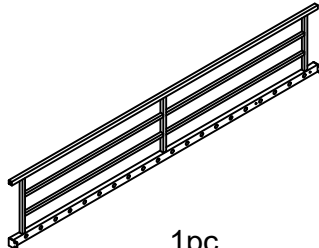
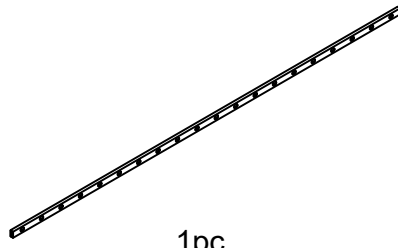
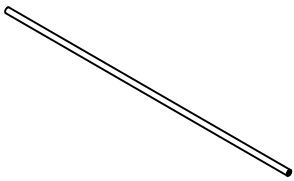
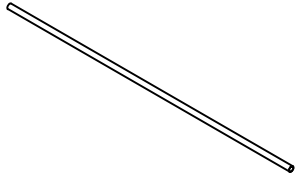
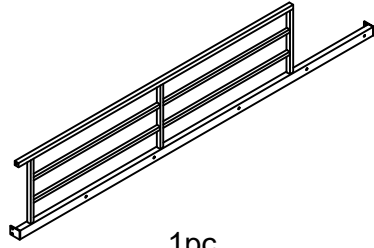
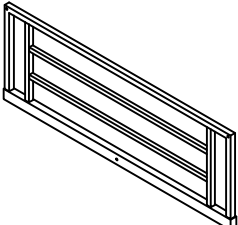
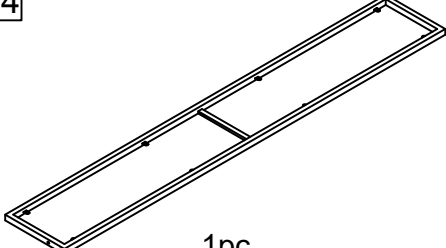
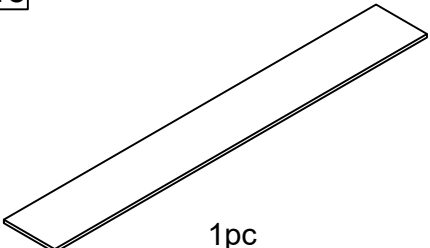
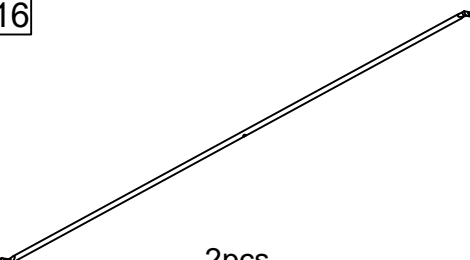
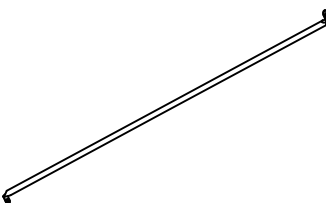
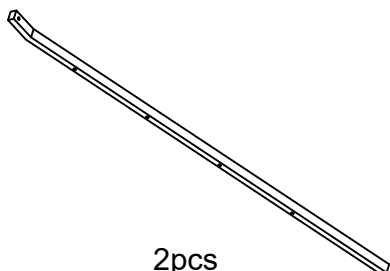

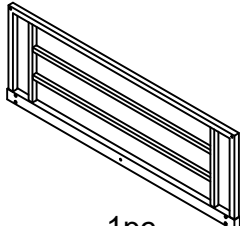
Replacement Parts, including additional guardrails, may be obtained from any of our (GIGACLOUD TECHNOLOGY (USA) INC) dealers.

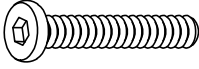
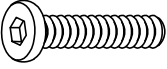
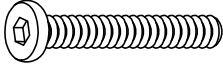
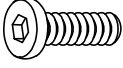

# Parts List

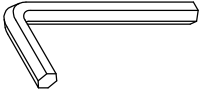
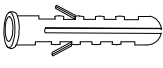
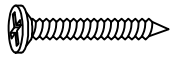
1  1pc	2  1pc	3  1pc
4  2pcs	5  2pcs	6  2pcs
7  2pcs	8  1pc	9  1pc
10  4pcs	11  16pcs	12  1pc
13  1pc	14  1pc	15  1pc
16  2pcs	17  2pcs	18  2pcs
19  4pcs	20  1pc	

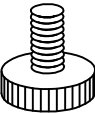
# Hardware List

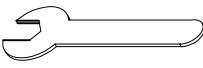
<p><b>A</b></p>  <p>M6*45mm      2pcs</p>	<p><b>B</b></p>  <p>M6*35mm      19pcs</p>	<p><b>C</b></p>  <p>M6*50mm      1pc</p>
<p><b>D</b></p>  <p>M6*16mm      13pcs</p>	<p><b>E</b></p>  <p>Ø4*12mm      8pcs</p>	<p><b>F</b></p>  <p>M6      1pc</p>
<p><b>G</b></p>  <p>2pcs</p>	<p><b>H</b></p>  <p>2pcs</p>	<p><b>I</b></p>  <p>2pcs</p>
<p><b>J</b></p>  <p>2pcs</p>	<p><b>K</b></p>  <p>4pcs</p>	<p><b>L</b></p>  <p>M6*12mm      42pcs</p>
<p><b>M</b></p>  <p>1pc</p>		

# STEP 1:

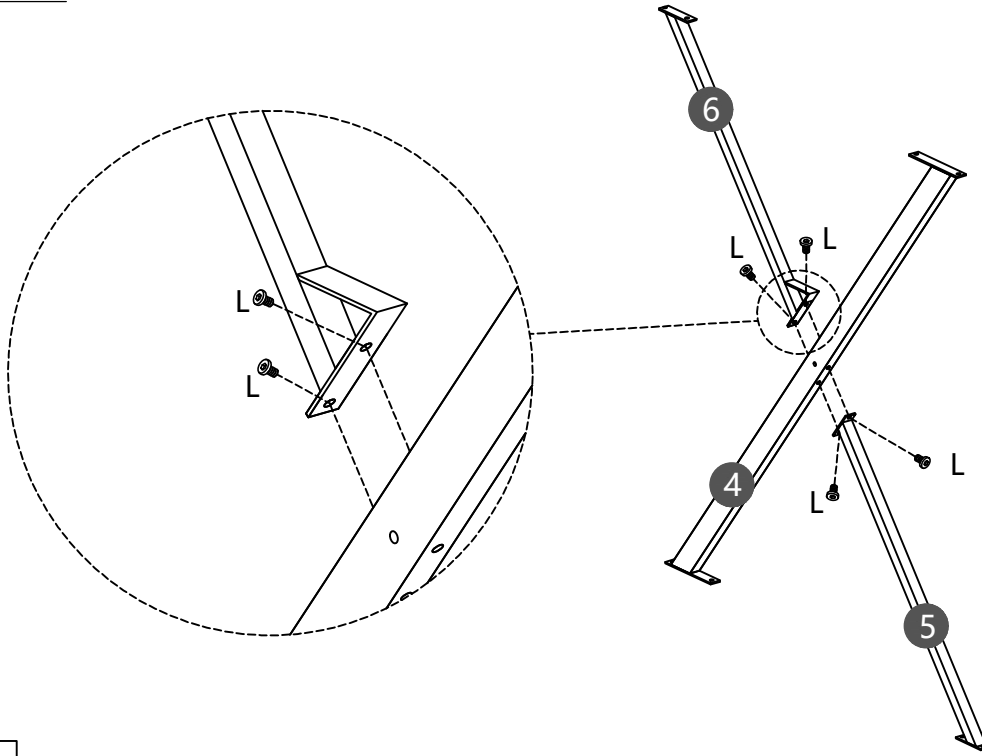

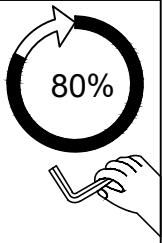

L

M6*12mm
8PCS

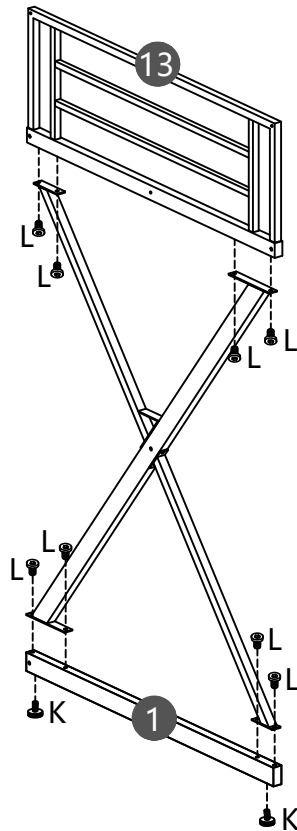

x 2



# STEP 2:

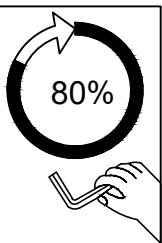

K	L
	
2PCS	M6*12mm
	8PCS



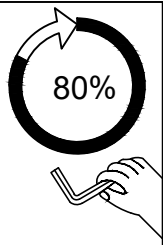
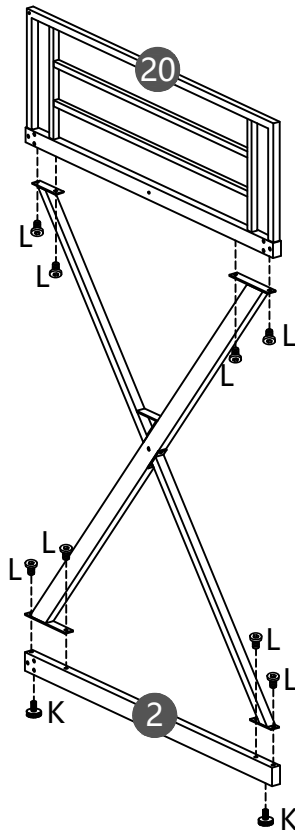

# STEP 3:

K	L
	
2PCS	8PCS



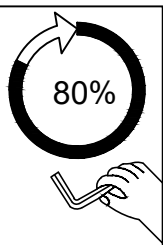
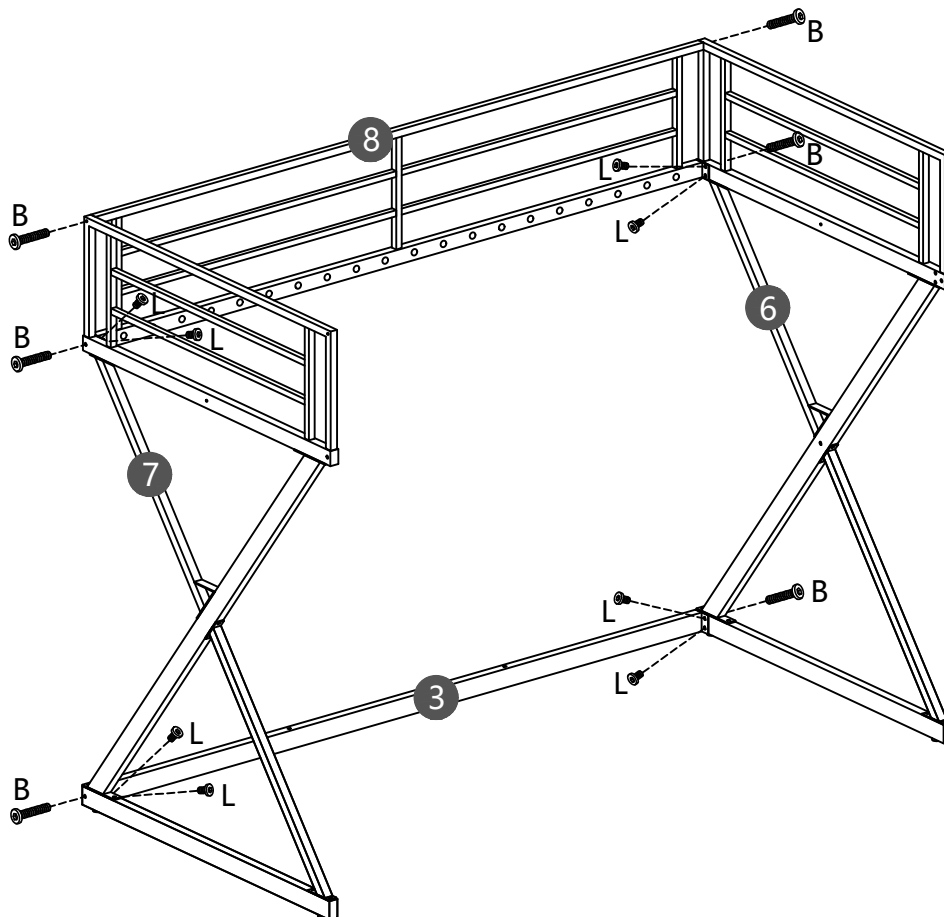

# STEP 4:

B	L
	
M6*35mm 6PCS	M6*12mm 8PCS

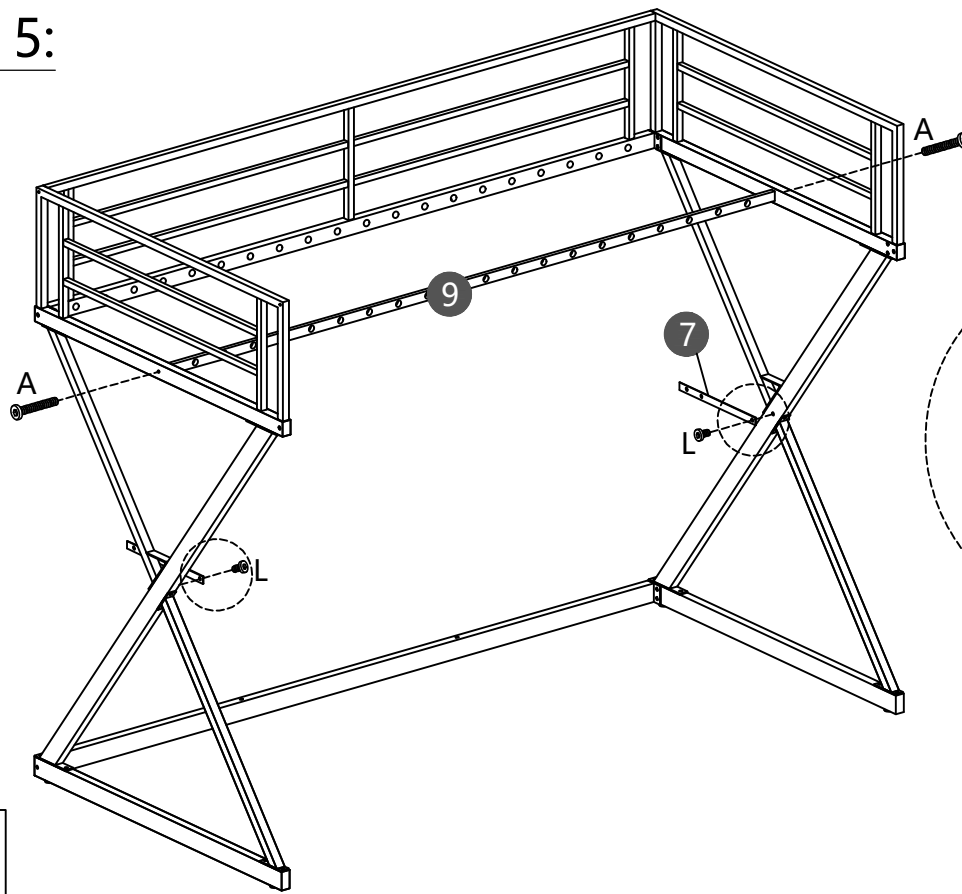

# STEP 5:



A	L
 M6*45mm	 M6*12mm
2PCS	2PCS



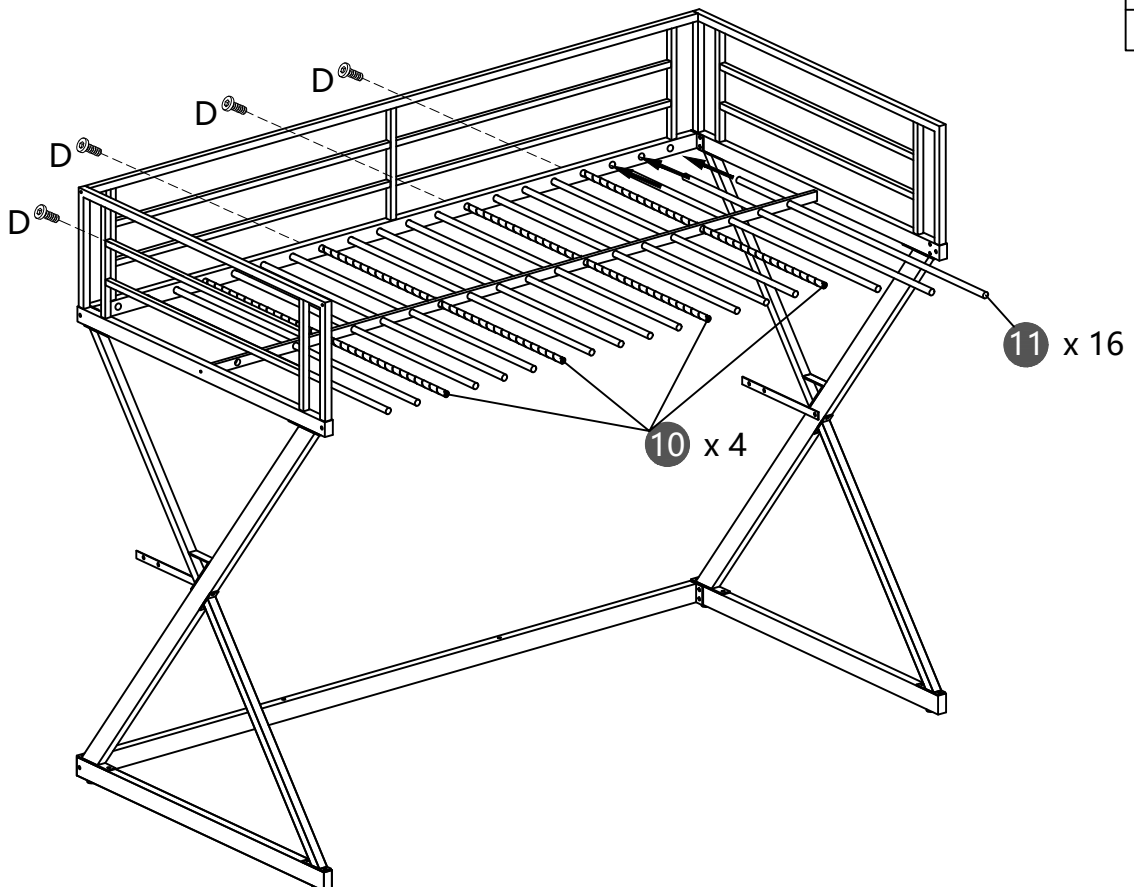

# STEP 6:

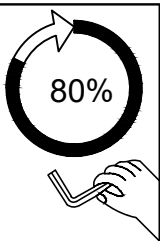

D
 M6*16mm
4PCS



# STEP 7:

<b>B</b>	<b>D</b>
 M6*35mm	 M6*16mm
3PCS	3PCS
	<b>L</b>
	 M6*12mm
	4PCS

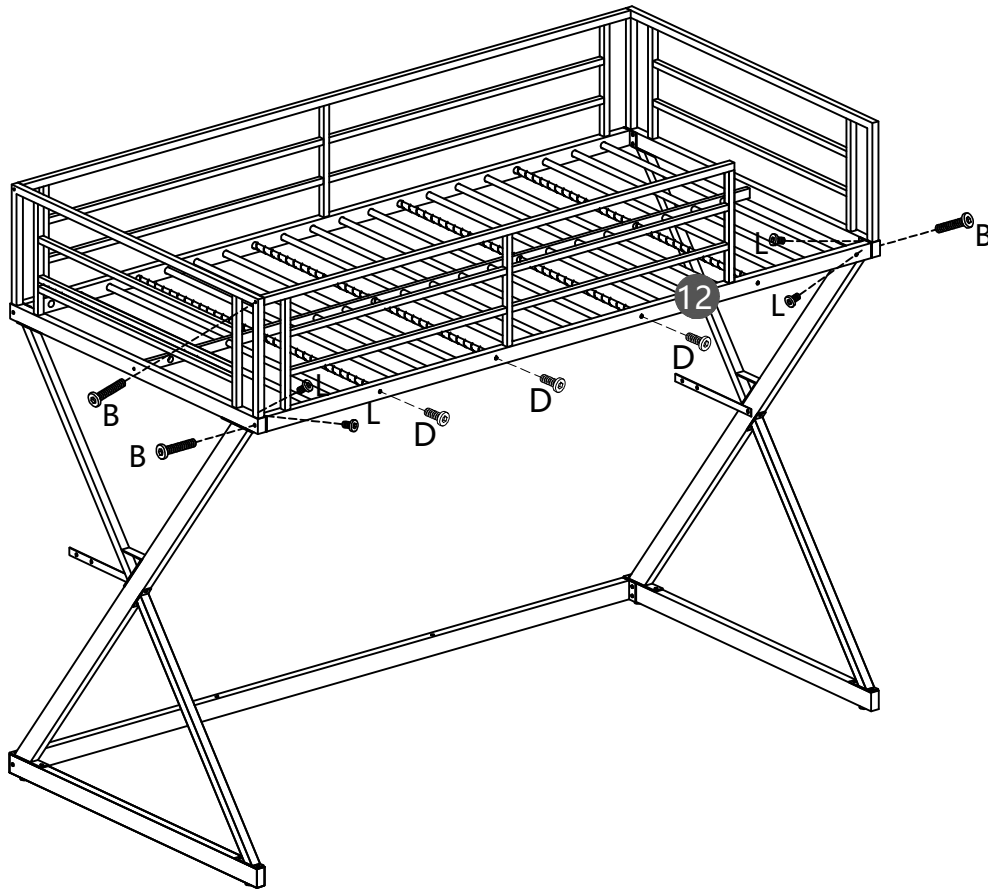

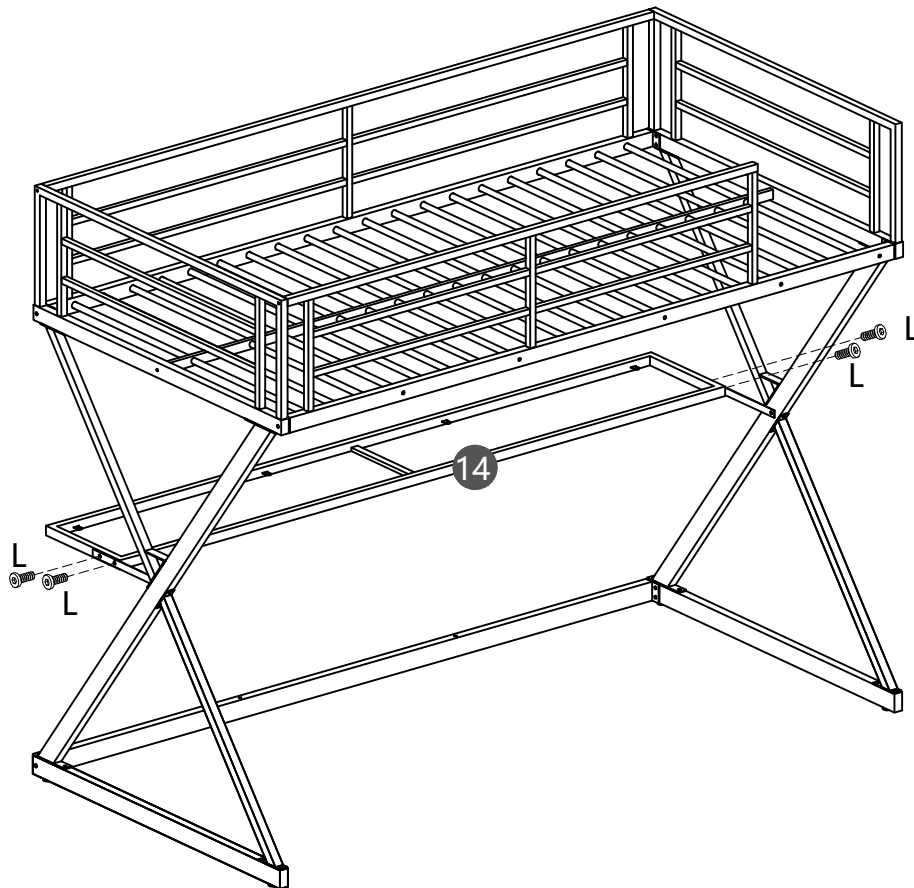

# STEP 8:

<b>L</b>
 M6*12mm
4PCS



# STEP 9:

B	D
 M6*35mm	 M6*16mm
1PC	6PCS

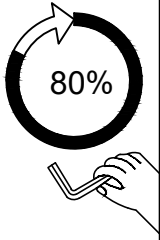
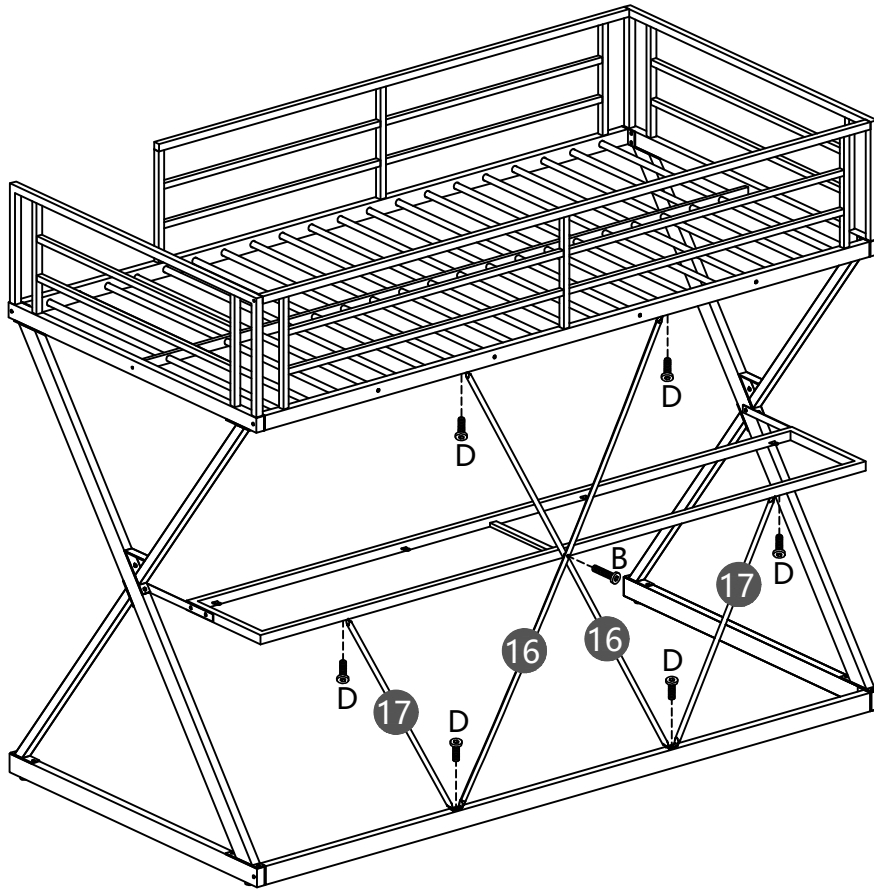

# STEP 10:

E
 Ø4*12mm
8PCS

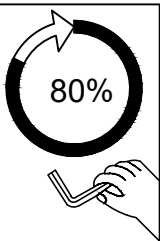
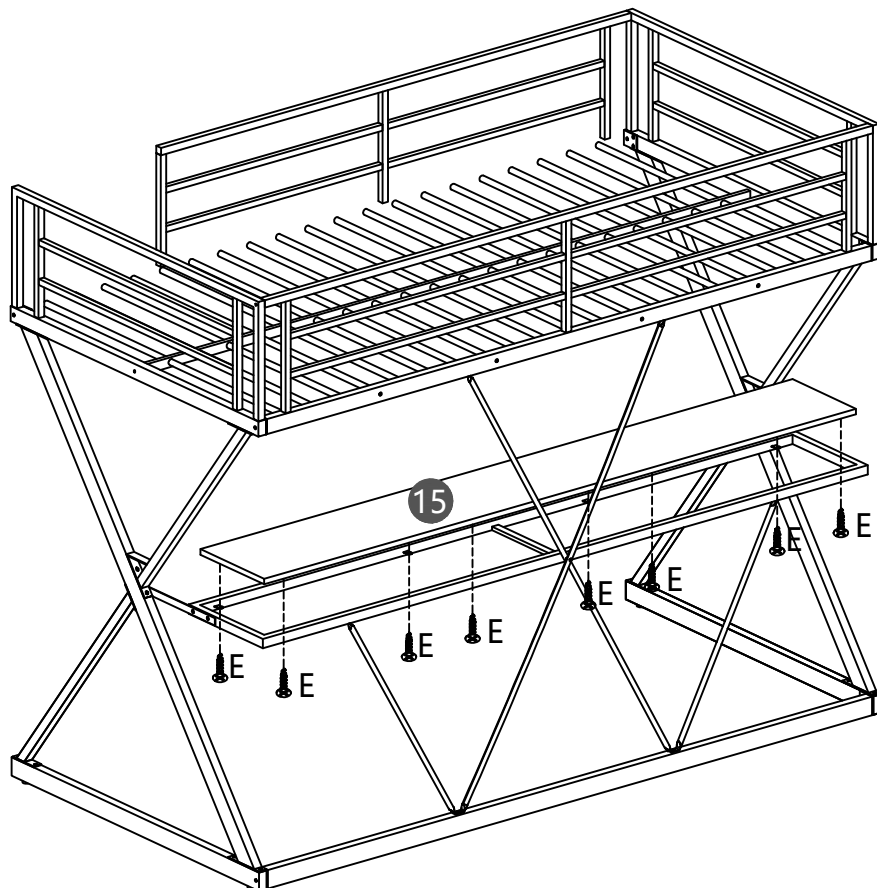

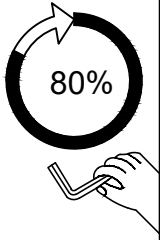
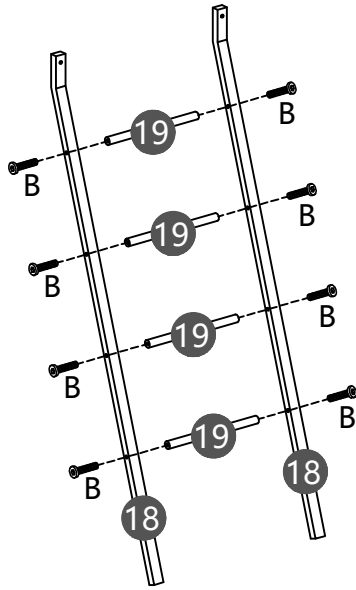

# STEP 11:

<b>B</b>

M6*35mm
8PCS

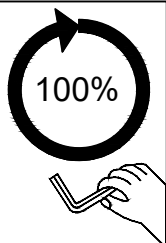
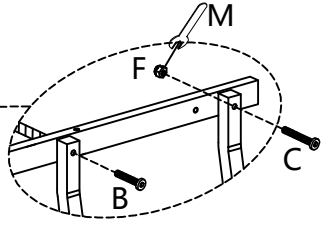
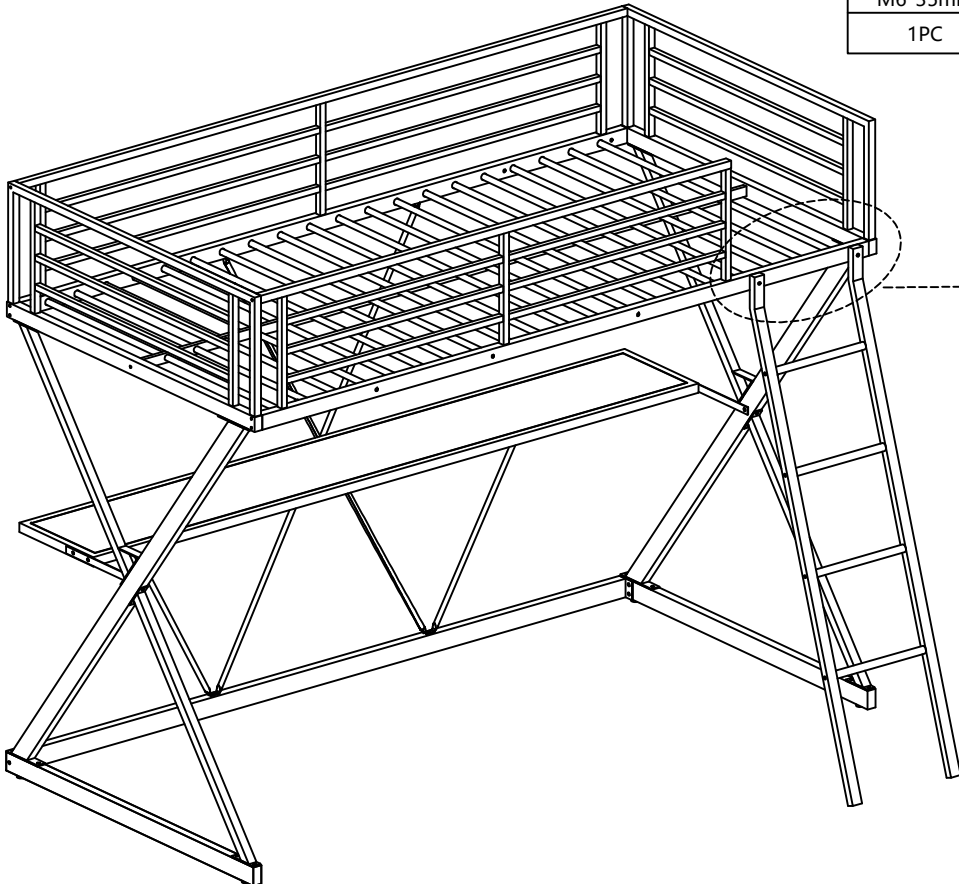

# STEP 12:

B	C	F
		
M6*35mm	M6*50mm	M6
1PC	1PC	1PC



# STEP 13:

H



2PCS

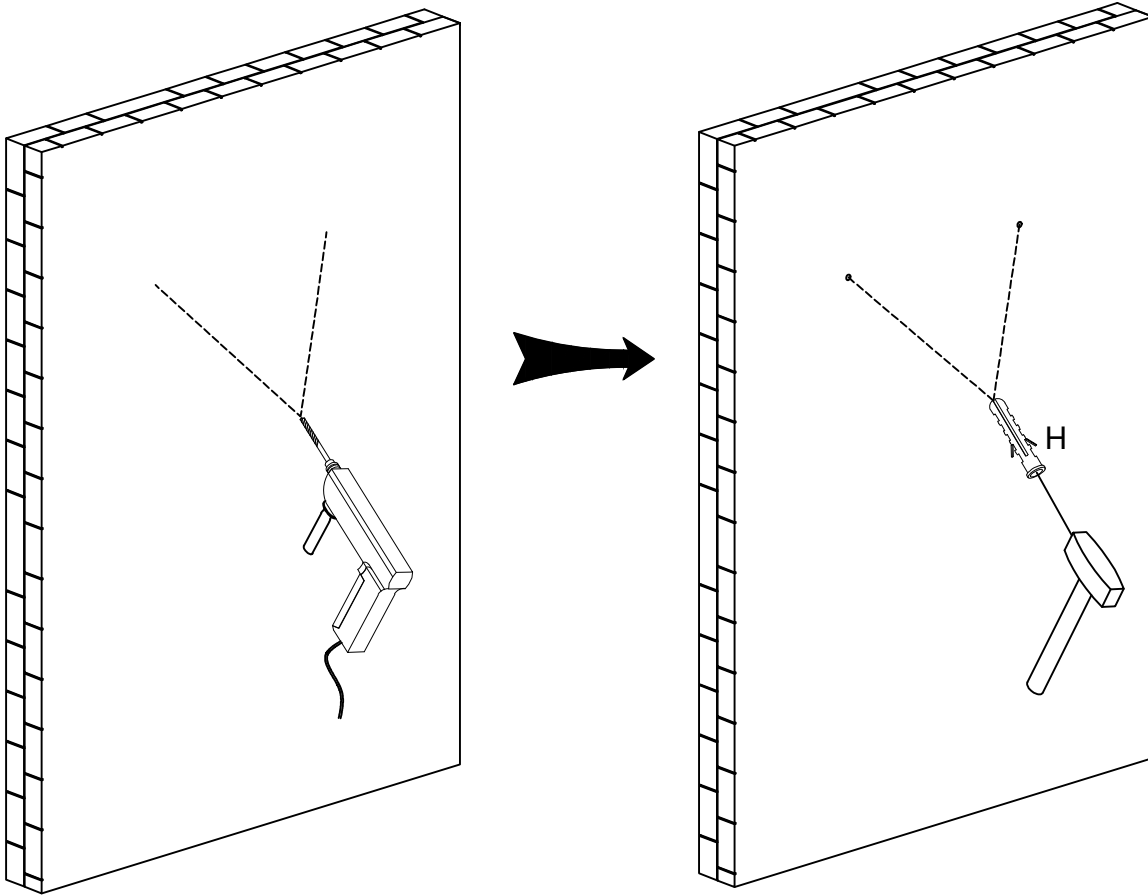

I



2PCS

J

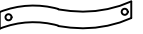

2PCS

