

CEILING FAN

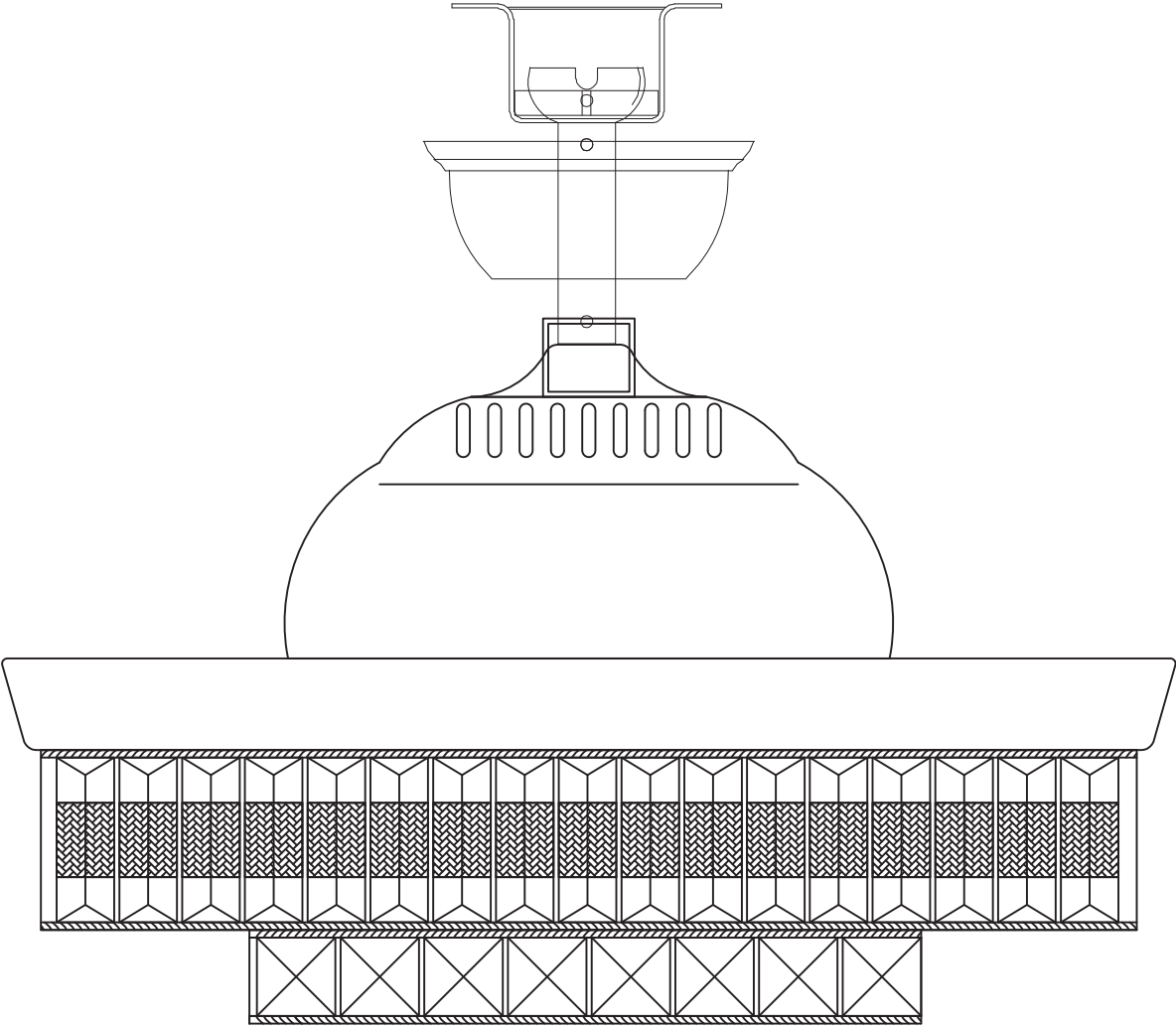

SAFETY INFORMATION



- Before connecting the power supply, make sure that the power supply used matches the specifications of the ceiling fan.
- All wiring must comply with national and local electrical codes ANSI/NFPA70. If you are not familiar with wiring, please use a qualified electrician.
- To reduce the risk of fire or electric shock, turn off the power to the fuse box or circuit breaker before installing the fan.
- To reduce the risk of personal injury, attach the fan directly to the building's support structure and ensure that it can accept at least 50 pounds (23kg).
- Make sure that the installation location allows the fan blades to rotate without obstacles.

Installation Location

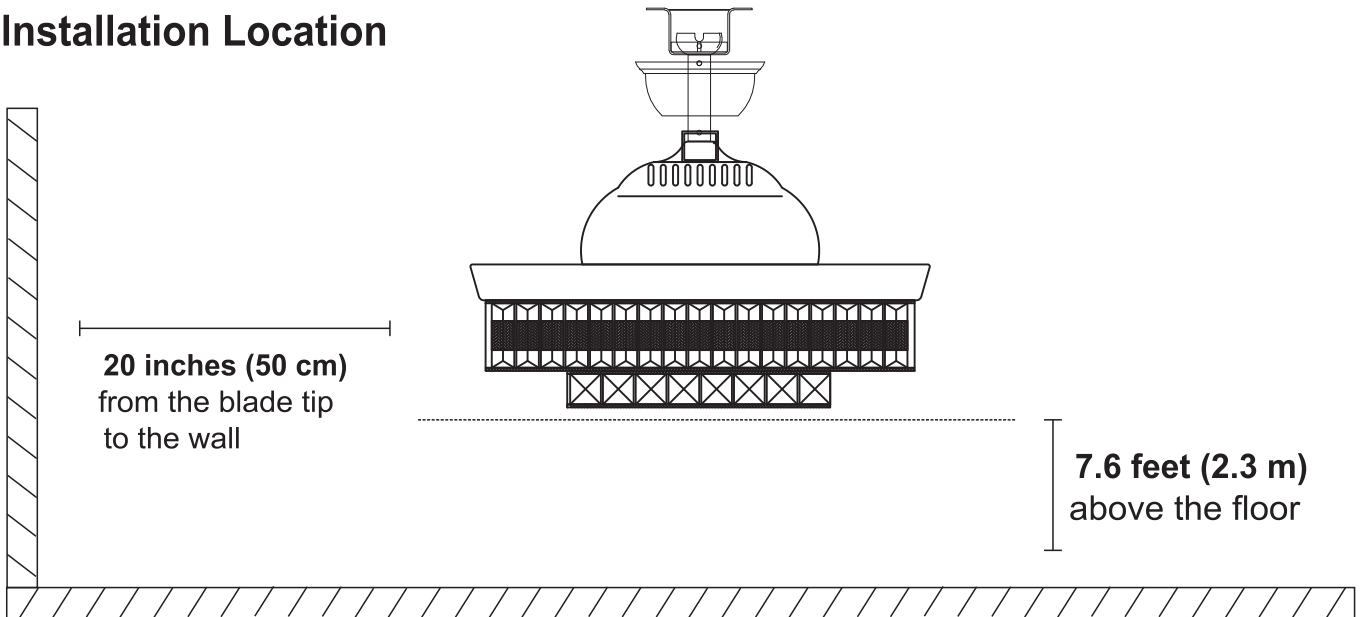

- Do not install the fan with wet hands.
- Do not insert foreign objects between the rotating fan blades.
- Do not bend the fan blades when installing or cleaning the fan.
- Do not disassemble or modify this product or use non-original parts without permission.
- Keep children away from your working area.
- Properly dispose of the fan's packaging material.
- Make sure the ceiling fan is firmly secure to the ceiling. Double check all connections before you restore power.
- Turn off the fan and wait for the blades to stop completely before performing any maintenance or cleaning.

PRE-INSTALLATION

Tools Required (Not Included)



Power Drill

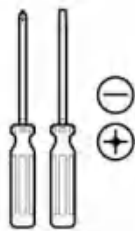

Screwdriver



Step Ladder



Wire Stripper

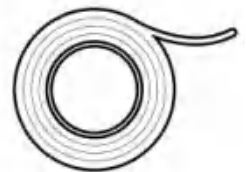

Electrical Tape

Parts List

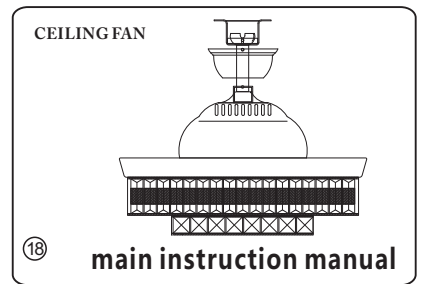
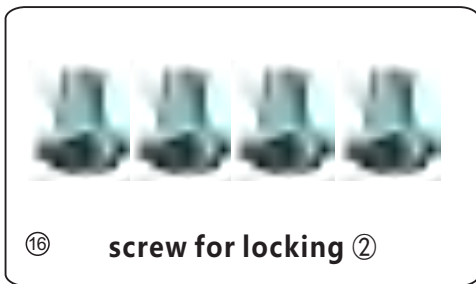
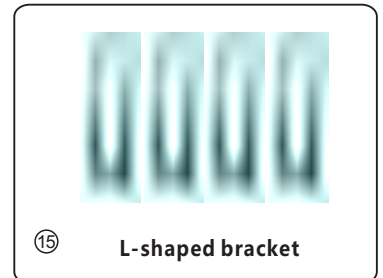
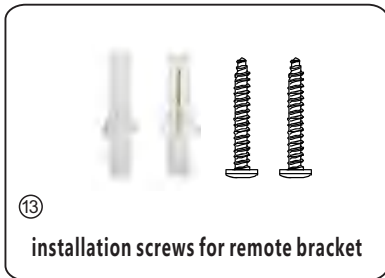
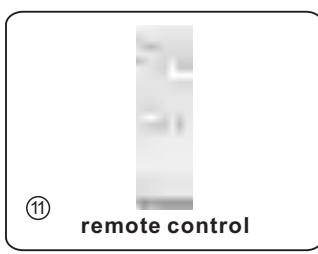
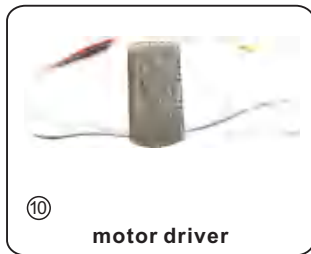
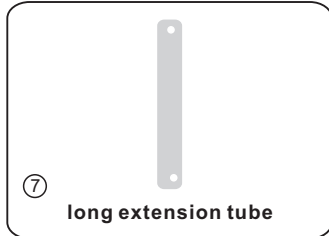
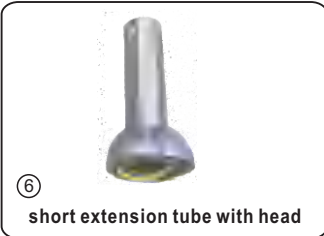
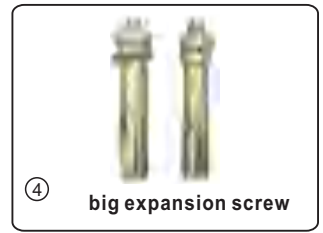
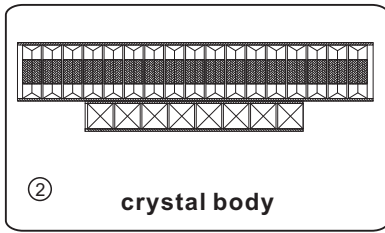
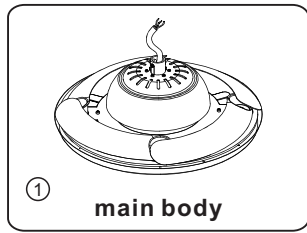

These accessories are already installed on the main body

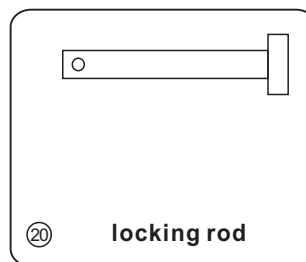
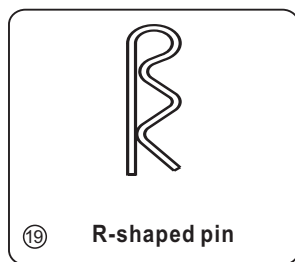

Installation procedure:

1. Installation of mounting bracket ③

A. To install this product on a concrete ceiling, decide a suitable distance between the two drilling holes based on the mounting bracket ③, then drill two 8 mm holes and drive in the big expansion screws ④, then fasten the mounting bracket to the ceiling.

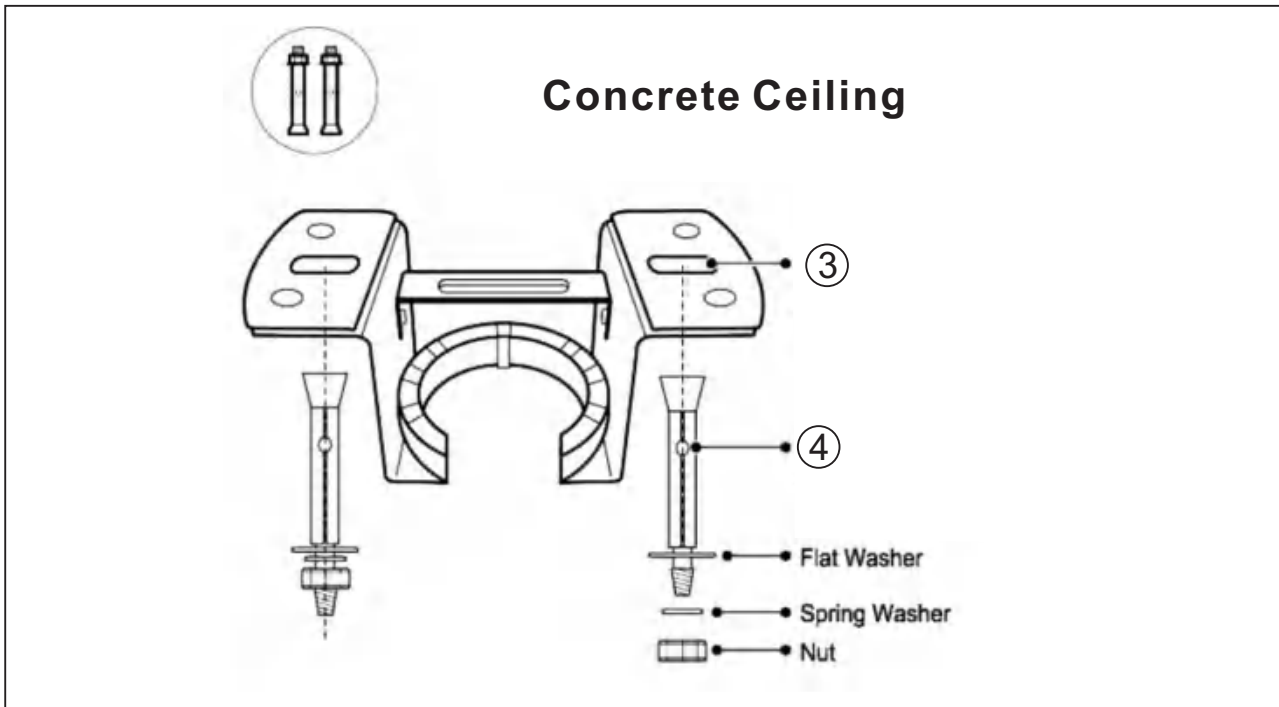

B. To install this product on a wooden ceiling, press the mounting bracket onto the ceiling and just simply lock on those four sets of self-tapping screws and washers ⑤.

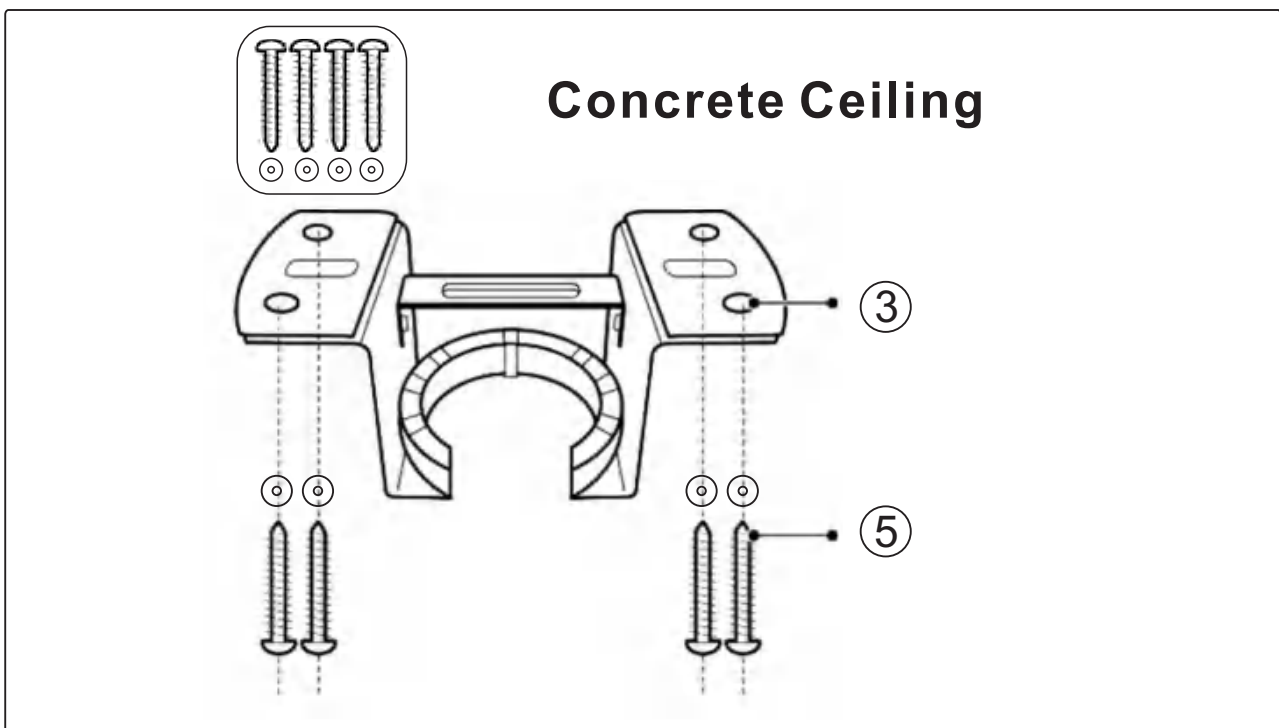

2. Installation of ⑥, ⑧, ⑨

A. Before this installation, you should decide to choose to use the short extension tube or the long extension tube. As the short extension tube is already assembled with the head, if you want to use the long one, you need to dismantle the short extension tube from ⑥ and replace it with the long extension tube ⑦.

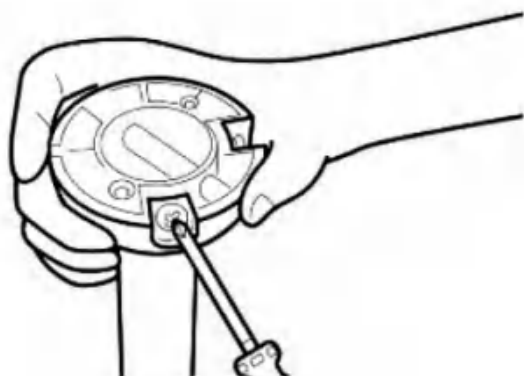

① Loosen the screws on the head.

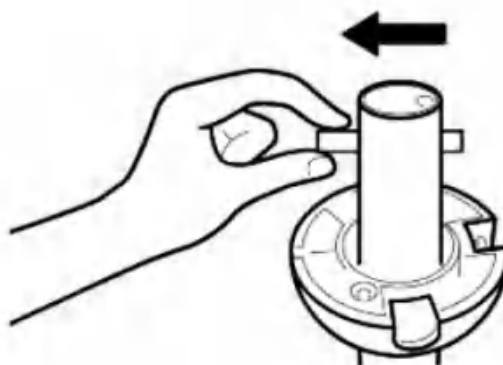

② Remove the short extension tube

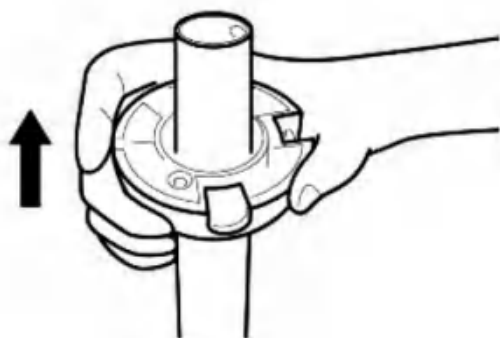

③ Take off the head from the short extension tube

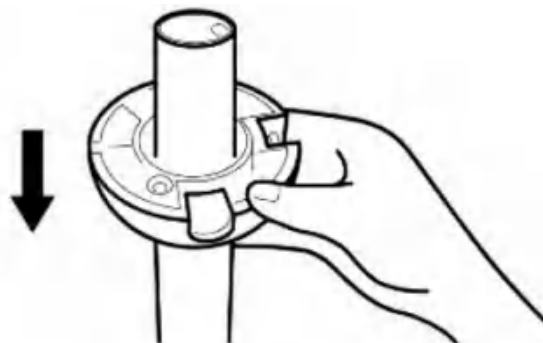

④ Install the head to an appropriate extension tube

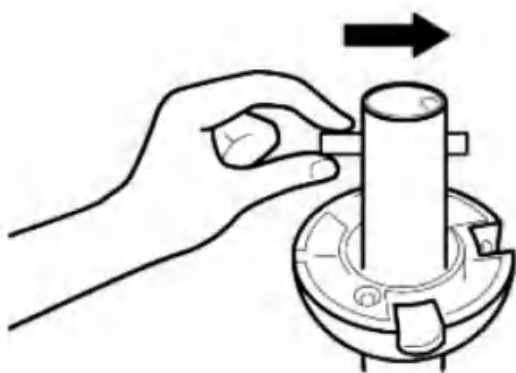

⑤ Insert the metal bar and tighten the screws.

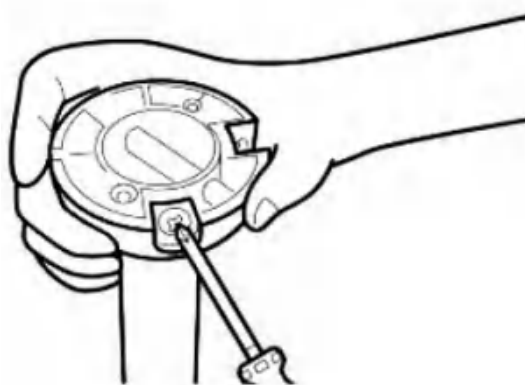

B. First, put big canopy ⑧ and small canopy with pad ⑨ onto short extension tube with head ⑥. During this, please pay attention to the direction of ⑧ and ⑨. The big opening of ⑧ should be toward the head of ⑥, and the black washer side of ⑨ should be toward the head of ⑥.

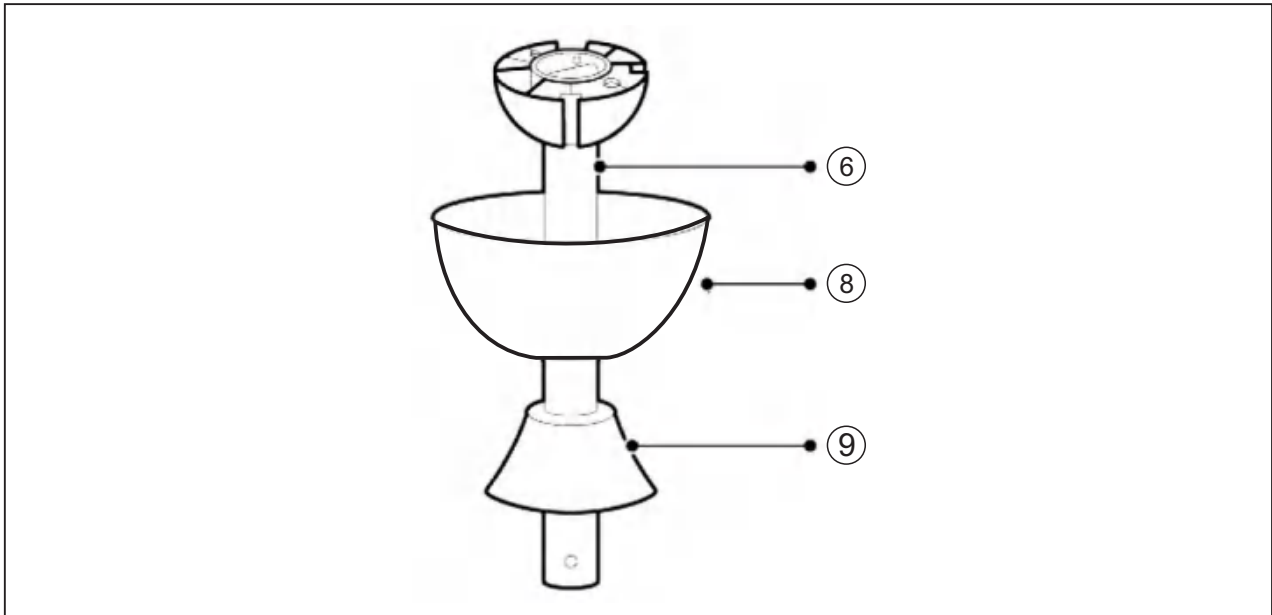

C. Remove R-shaped pin ⑲ and locking rod ⑳ from ①, lead the wires on ① through ⑥, and assemble ⑥, ⑧, ⑨ onto the central tube of ①. During this, first align the holes on ⑥ with holes on central tube well and insert the ⑳ and then lock it with ⑲. The wires inside the central tube may stop the insertion, then you may need some minor adjustment of the wire's position to manage it.

D. Tighten up the two screws on central tube of ①

E. Push down the small canopy with pad ⑨ to the bottom of ①.

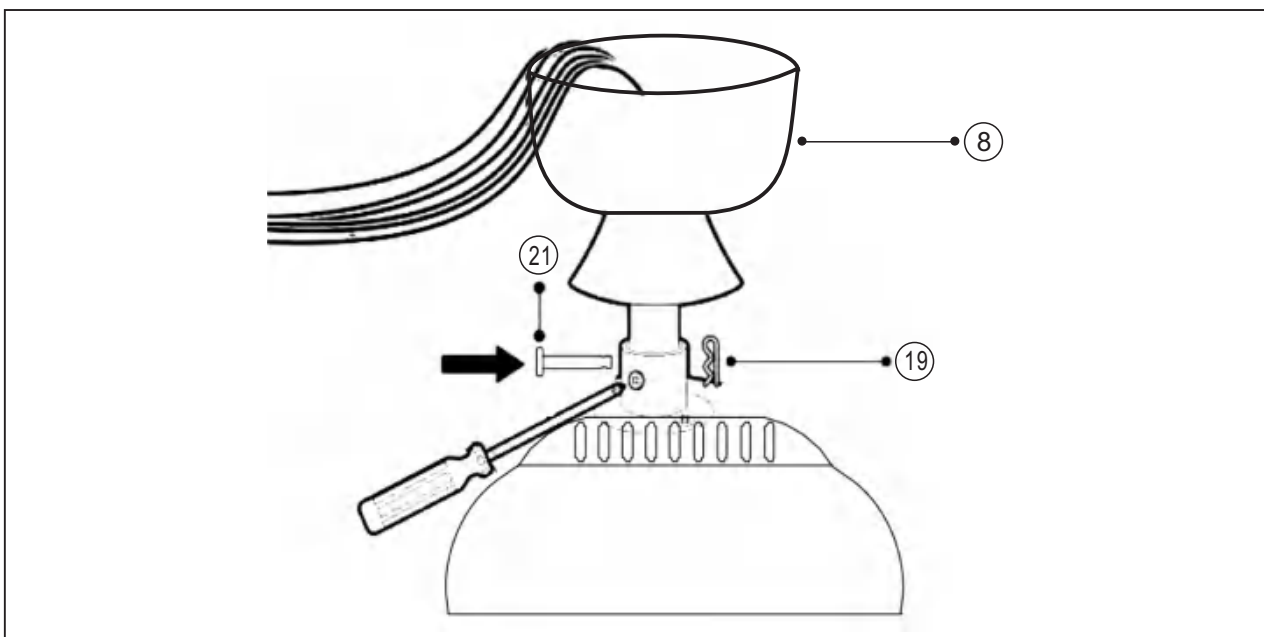

3.Assembling the crystal body ② to the main body ①.

A. Connect the wires of LED driver ⑭. On the LED driver, the blue(live)/white(neutral) wire should be connected to the blue (live)/white(neutral) wire on main body ① separately. The white terminal block should be connected to LED light source disk.

All these done, make sure to attach the LED driver ⑭ to the metal plate by those two magnetic feet so that it won't drop down during usage.

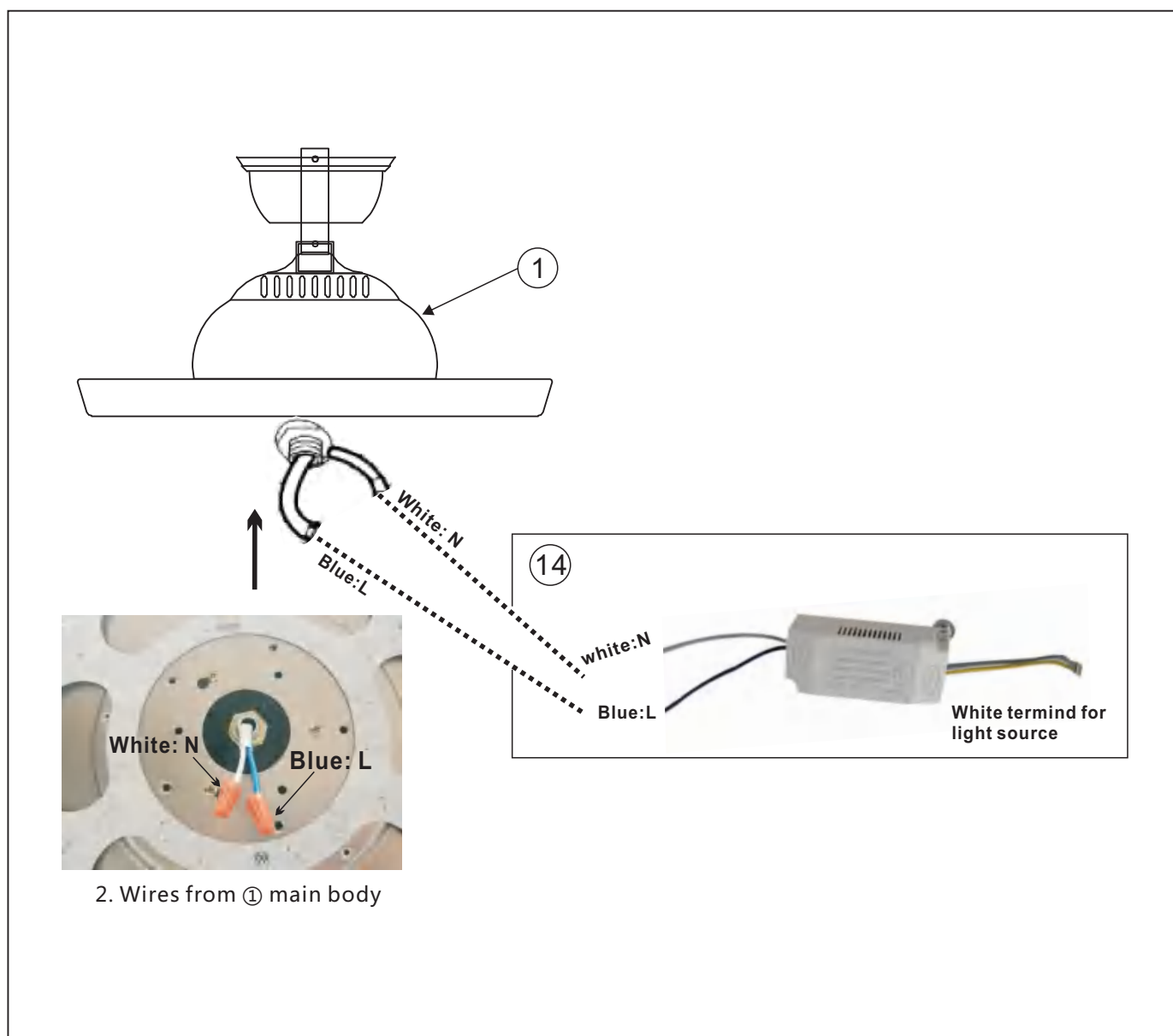

B. After wiring, follow the below fo assemble ② Crystal body Make sure that the L-shaped brackets ⑮ should be hidden inside the body.

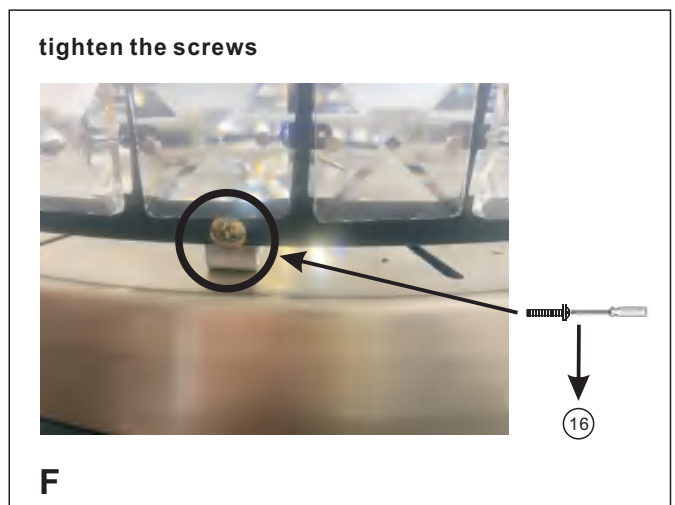
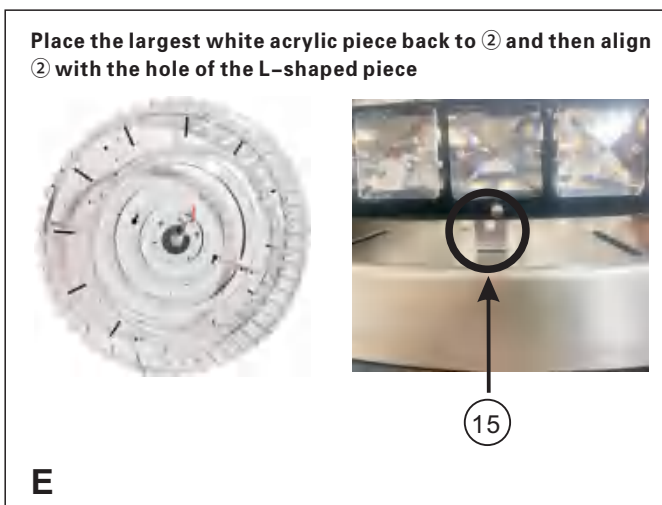
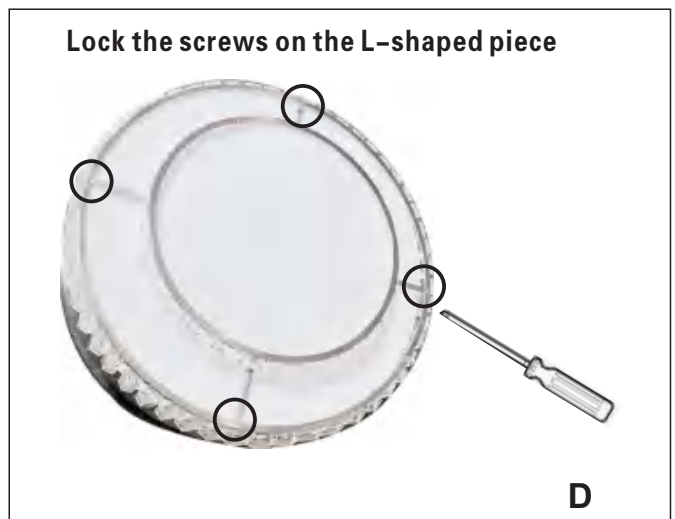
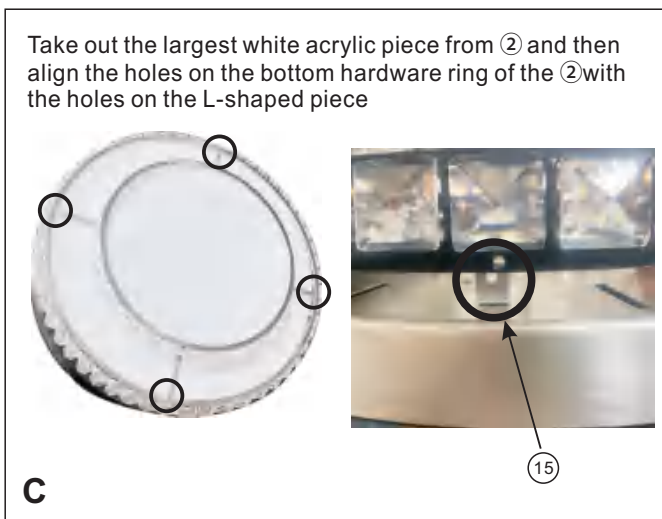
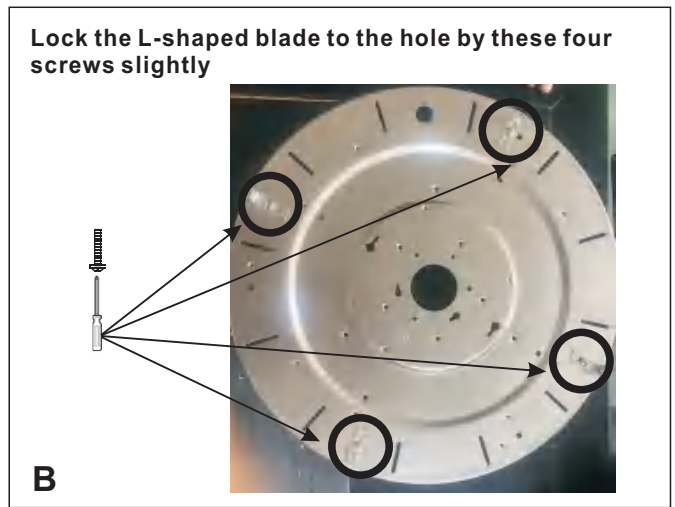
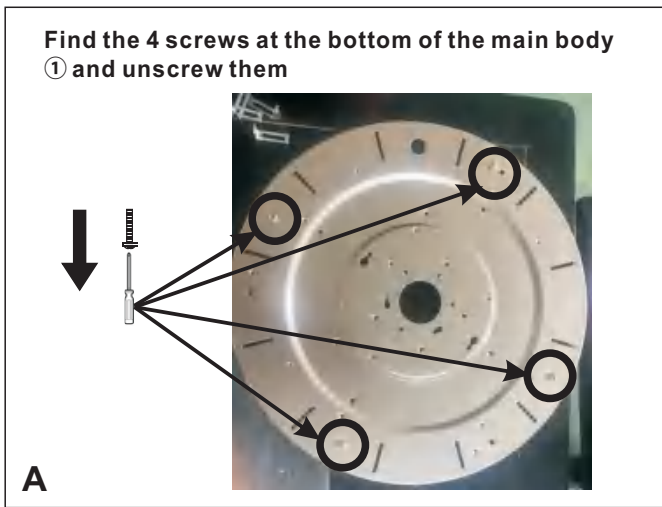

4. Installion of main body ① to mounting bracket ③

Hang the head of ⑥ onto the mounting bracket ③. To do this correctly, you need to align the rib on ③ with the groove on ⑥, making sure this rib completely sits into the groove. Otherwise the motor driver ⑩ may not be able to fit into the mounting bracket ③ in the following installtion.

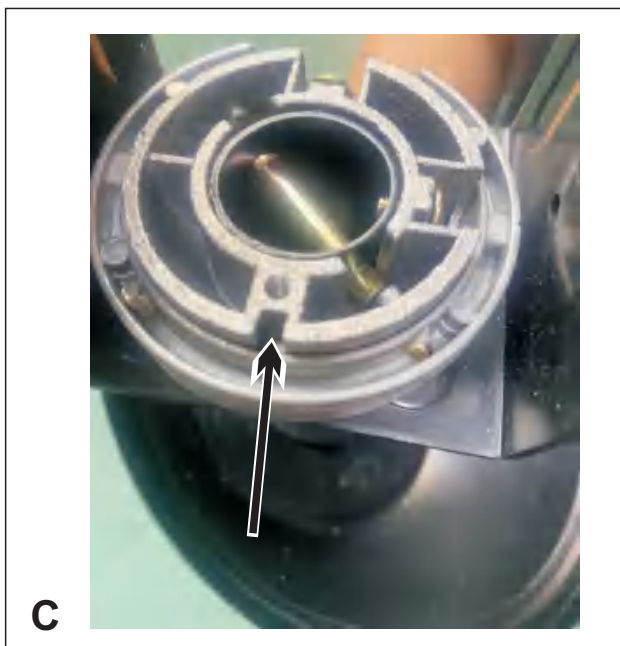
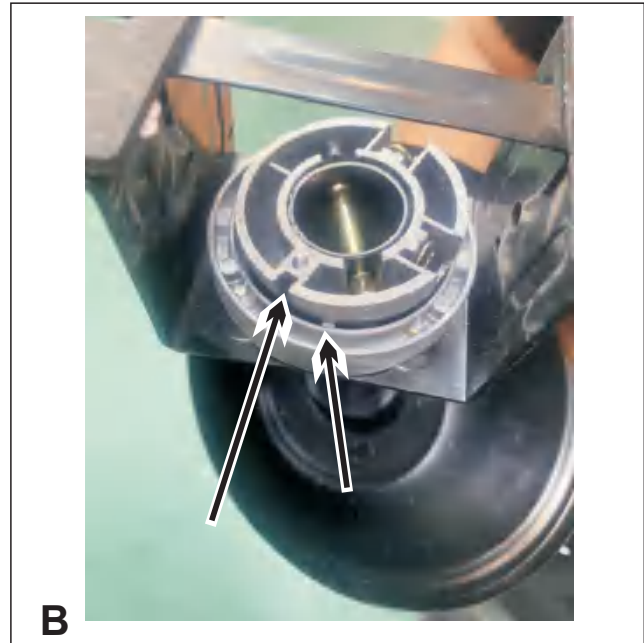
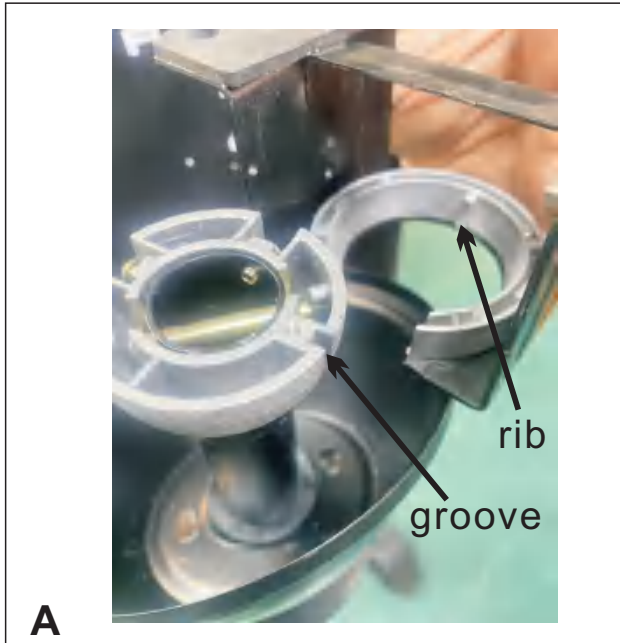

⚠ Note:

The screws on the hanging ball must be fully tightened, otherwise it will shake and cause safety hazards.

5. Wiring the motor driver

A. Put the motor driver ⑩ into the mounting bracket ③. Tidy up the wires so it's more convenient for wiring. on the motor driver, the black (live)/white (neutral) wire pair is for input power supply; the blue (live)/white (neutral) wire pair is to be connected with blue and white wire from the main body ① separately. The white terminal is for the white terminal on the main body ①. After all these wiring, please remember to connect the yellow/green wire from the head of ⑥ to the earthing wire of your power supply.

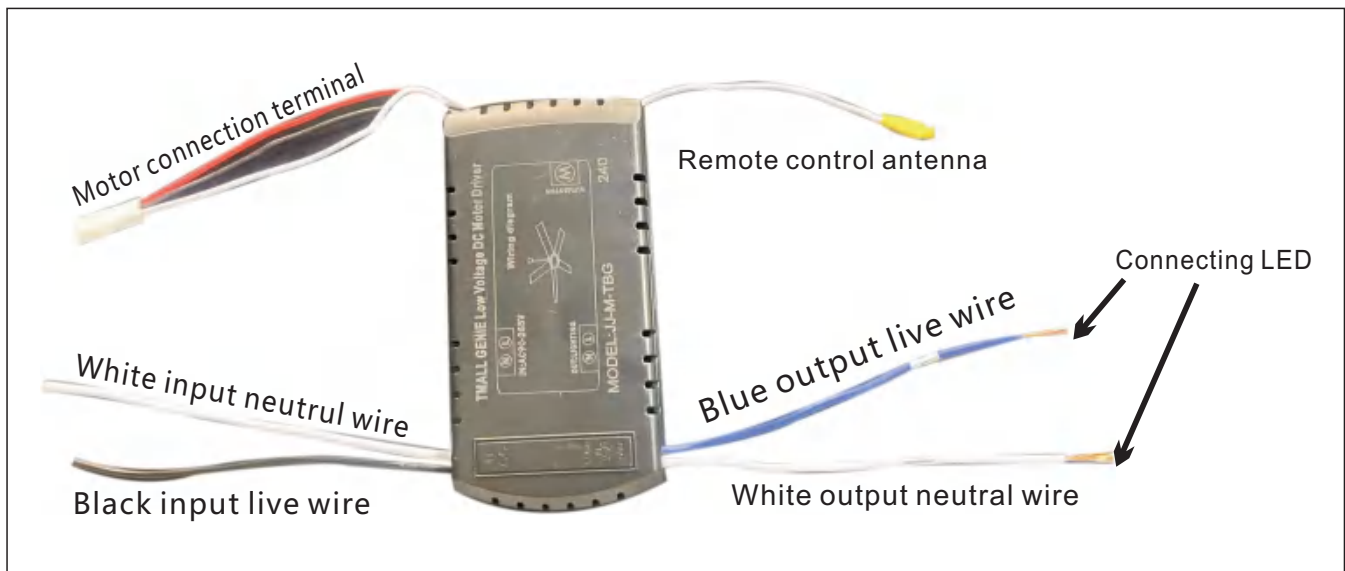

B. Keep the antenna wire outside big canopy ⑧ to ensure good signal transmission of the motor control.

C. Arrange the wiring appropriately inside the mounting bracket ③ so that it's convenient to fix on the big canopy ⑧.

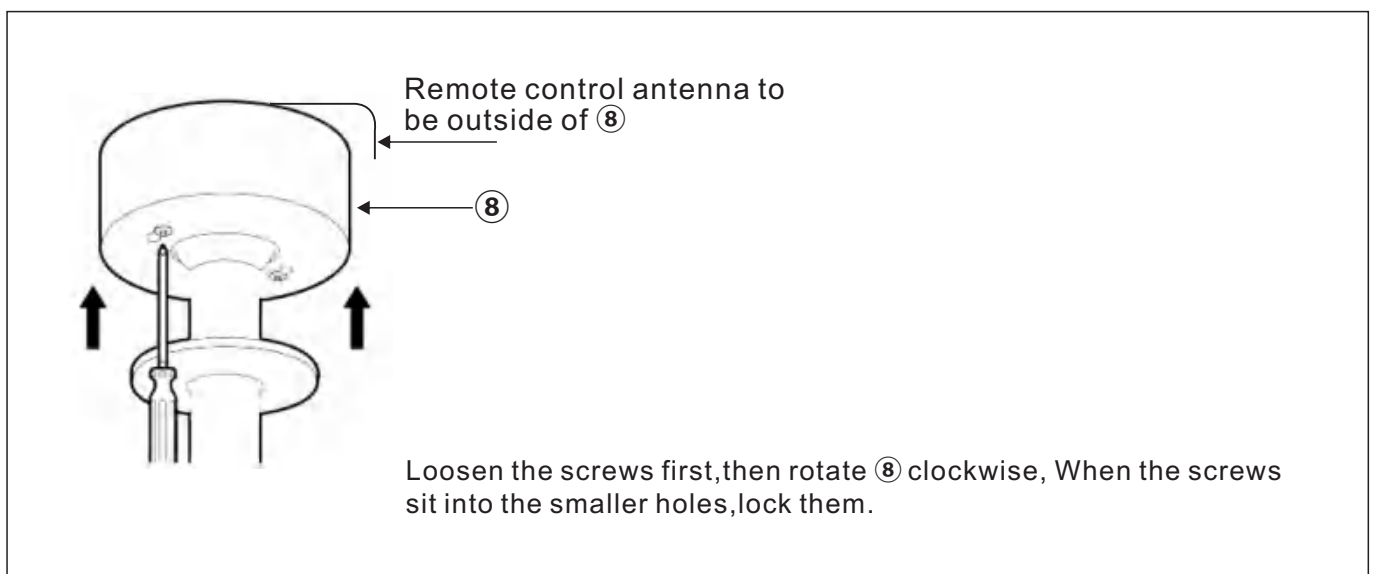

Now you've finished the installation of this product. Congratulations!
Next we need to learn the details about the fan control, music control and light control modes.

Remote control:

Basically, the remote control can control different fan working modes, the light's power supply and the light temperature. It can't control light color or music play.

EASY TO USE REMOTE CONTROL



Product Feature

Natural Wind

Using aerodynamics, this ceiling fan light can produce natural, pleasant, comfortable and healthy wind to your rooms and indoor areas. With its three-dimensional circulation air supply, it can circulate your indoor air and adjust the room temperature quickly. Thanks to its unique positive and negative air supply and speed regulation technology, people can enjoy the cool feeling in hot summers and the warm environment in cold winter. It just helps to create a more pleasant house.

Best Partner of Air Condition

It can solve the short comings of slow diffusion of air conditioning. In hot days, using the forward rotation function of this product it can accelerate the diffusion of cold air, so that the indoor temperature will drop rapidly; On the contrary, the reverse rotation function can accelerate the spread of the heat and increase the indoor temperature quickly. This product can shorten the cooling and heating time of air conditioner and save about 30% of electricity consumption. It is the best partner of air condition.

Ultra Silent and Energy Saving

Coupled with high-quality and efficient bearings and advanced frequency conversion technology, the motor of this product is composed of permanently magnetic rotor and 100% copper winding stator. All these factors make it run efficiently, quietly and smoothly.

**Thank you for purchasing our company's ceiling fan lights .
Please read this instruction manual carefully before installation
and keep it for future reference.**