

Before returning this product call

1-800-4-DEWALT

IF YOU SHOULD EXPERIENCE A PROBLEM WITH YOUR DEWALT
PURCHASE,

CALL 1-800-4 DEWALT

IN MOST CASES, A DEWALT REPRESENTATIVE CAN RESOLVE
YOUR PROBLEM OVER THE PHONE.

IF YOU HAVE A SUGGESTION OR COMMENT, GIVE US A CALL.
YOUR FEEDBACK IS VITAL TO THE SUCCESS OF DEWALT'S
QUALITY IMPROVEMENT PROGRAM.

Questions? Visit www.DEWALT.com

**INSTRUCTION MANUAL
GUIDE D'UTILISATION
MANUAL DE INSTRUCCIONES**

INSTRUCTIVO DE OPERACIÓN, CENTROS DE SERVICIO Y PÓLIZA
DE GARANTÍA. **ADVERTENCIA:** LÉASE ESTE INSTRUCTIVO
ANTES DE USAR EL PRODUCTO.

DEWALT®

DCN690, DCN692

20V Max* Cordless Framing Nailer

Cloueur pour charpente sans fil 20V max*

Clavadora inalámbrica de 20 V max*

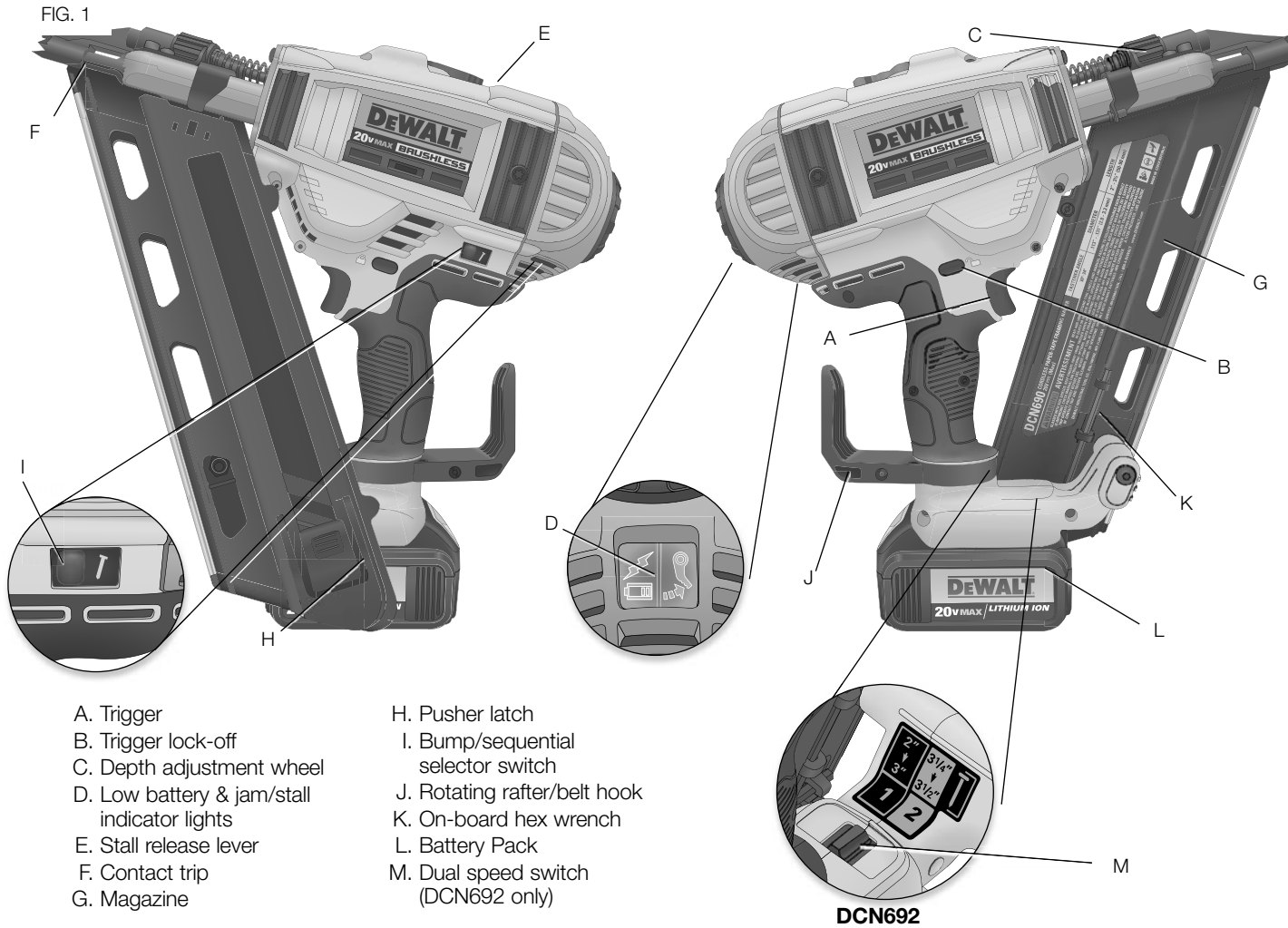

Definitions: Safety Guidelines

The definitions below describe the level of severity for each signal word. Please read the manual and pay attention to these symbols.

⚠ DANGER: Indicates an imminently hazardous situation which, if not avoided, **will** result in **death or serious injury**.

⚠ WARNING: Indicates a potentially hazardous situation which, if not avoided, **could** result in **death or serious injury**.

⚠ CAUTION: Indicates a potentially hazardous situation which, if not avoided, **may** result in **minor or moderate injury**.

NOTICE: Indicates a practice **not related to personal injury** which, if not avoided, **may** result in **property damage**.

TOOL SPECIFICATIONS

Firing Mode	Selective: Bump or Sequential
Voltage	20
Height	13.5" (346 mm)
Width	4" (104 mm)
Length	13.25" (335 mm)
Weight	7.80 lbs. (3.538 kg)
Magazine Angle	33°
Loading Capacity	Up to 55 nails



NAIL SPECIFICATIONS

	Clipped Head
Nail Lengths	2"-3-1/2" (50 mm-90 mm)
Shank Diameters	.113"-.131" (2.8 mm-3.3 mm)
Nail Stick Angles	30°-34°
Shank Types	Smooth and Ring

IF YOU HAVE ANY QUESTIONS OR COMMENTS ABOUT THIS OR ANY DEWALT TOOL, CALL US TOLL FREE AT: 1-800-4-DEWALT (1-800-433-9258).



WARNING: To reduce the risk of injury, read the instruction manual.

General Power Tool Safety Warnings



WARNING! Read all safety warnings and all instructions. Failure to follow the warnings and instructions may result in electric shock, fire and/or serious injury.

SAVE ALL WARNINGS AND INSTRUCTIONS FOR FUTURE REFERENCE

The term “power tool” in the warnings refers to your mains-operated (corded) power tool or battery-operated (cordless) power tool.

1) WORK AREA SAFETY

- Keep work area clean and well lit.** Cluttered or dark areas invite accidents.
- Do not operate power tools in explosive atmospheres, such as in the presence of flammable liquids, gases or dust.** Power tools create sparks which may ignite the dust or fumes.
- Keep children and bystanders away while operating a power tool.** Distractions can cause you to lose control.

2) ELECTRICAL SAFETY

- Power tool plugs must match the outlet. Never modify the plug in any way. Do not use any adapter plugs with earthed (grounded) power tools.** Unmodified plugs and matching outlets will reduce risk of electric shock.
- Avoid body contact with earthed or grounded surfaces such as pipes, radiators, ranges and refrigerators.** There is an increased risk of electric shock if your body is earthed or grounded.
- Do not expose power tools to rain or wet conditions.** Water entering a power tool will increase the risk of electric shock.
- Do not abuse the cord. Never use the cord for carrying, pulling or unplugging the power tool. Keep cord away from heat, oil, sharp edges or moving parts.** Damaged or entangled cords increase the risk of electric shock.
- When operating a power tool outdoors, use an extension cord suitable for outdoor use.** Use of a cord suitable for outdoor use reduces the risk of electric shock.
- If operating a power tool in a damp location is unavoidable, use a ground fault circuit interrupter (GFCI) protected supply.** Use of a GFCI reduces the risk of electric shock.

3) PERSONAL SAFETY

- Stay alert, watch what you are doing and use common sense when operating a power tool. Do not use a power tool while you are tired or under the influence of drugs, alcohol or medication.** A moment of inattention while operating power tools may result in serious personal injury.
- Use personal protective equipment. Always wear eye protection.** Protective equipment such as dust mask, non-skid safety shoes, hard hat, or hearing protection used for appropriate conditions will reduce personal injuries.
- Prevent unintentional starting. Ensure the switch is in the off position before connecting to power source and/or battery pack, picking up or carrying the tool.** Carrying power tools with your finger on the switch or energizing power tools that have the switch on invites accidents.
- Remove any adjusting key or wrench before turning the power tool on.** A wrench or a key left attached to a rotating part of the power tool may result in personal injury.
- Do not overreach. Keep proper footing and balance at all times.** This enables better control of the power tool in unexpected situations.

- Dress properly. Do not wear loose clothing or jewelry. Keep your hair, clothing and gloves away from moving parts.** Loose clothes, jewelry or long hair can be caught in moving parts.
- If devices are provided for the connection of dust extraction and collection facilities, ensure these are connected and properly used.** Use of dust collection can reduce dust-related hazards.

4) POWER TOOL USE AND CARE

- Do not force the power tool. Use the correct power tool for your application.** The correct power tool will do the job better and safer at the rate for which it was designed.
- Do not use the power tool if the switch does not turn it on and off.** Any power tool that cannot be controlled with the switch is dangerous and must be repaired.
- Disconnect the plug from the power source and/or the battery pack from the power tool before making any adjustments, changing accessories, or storing power tools.** Such preventive safety measures reduce the risk of starting the power tool accidentally.
- Store idle power tools out of the reach of children and do not allow persons unfamiliar with the power tool or these instructions to operate the power tool.** Power tools are dangerous in the hands of untrained users.
- Maintain power tools. Check for misalignment or binding of moving parts, breakage of parts and any other condition that may affect the power tool's operation. If damaged, have the power tool repaired before use.** Many accidents are caused by poorly maintained power tools.
- Keep cutting tools sharp and clean.** Properly maintained cutting tools with sharp cutting edges are less likely to bind and are easier to control.
- Use the power tool, accessories and tool bits, etc. in accordance with these instructions, taking into account the working conditions and the work to be performed.** Use of the power tool for operations different from those intended could result in a hazardous situation.

5) BATTERY TOOL USE AND CARE

- Recharge only with the charger specified by the manufacturer.** A charger that is suitable for one type of battery pack may create a risk of fire when used with another battery pack.
- Use power tools only with specifically designated battery packs.** Use of any other battery packs may create a risk of injury and fire.
- When battery pack is not in use, keep it away from other metal objects, like paper clips, coins, keys, nails, screws, or other small metal objects, that can make a connection from one terminal to another.** Shorting the battery terminals together may cause burns or a fire.
- Under abusive conditions, liquid may be ejected from the battery; avoid contact. If contact accidentally occurs, flush with water. If liquid contacts eyes, additionally seek medical help.** Liquid ejected from the battery may cause irritation or burns.

6) SERVICE

- Have your power tool serviced by a qualified repair person using only identical replacement parts.** This will ensure that the safety of the power tool is maintained.

Nailer Safety Warnings

- Always assume that the tool contains fasteners.** Careless handling of the nailer can result in unexpected firing of fasteners and personal injury.
- Do not point the tool towards yourself or anyone nearby.** Unexpected triggering will discharge a fastener causing an injury.
- Do not actuate the tool unless the tool is placed firmly against the workpiece.** If the tool is not in contact with the workpiece, the fastener may be deflected away from your target.
- Disconnect the tool from the power source when the fastener jams in the tool.** While removing a jammed fastener, the tacker may be accidentally activated if it is plugged in.

- **Use caution while removing a jammed fastener.** The mechanism may be under compression and the fastener may be forcefully discharged while attempting to free a jammed condition.
- **Do not use this nailer for fastening electrical cables.** It is not designed for electric cable installation and may damage the insulation of electric cables thereby causing electric shock or fire hazards.

Additional Nailer Safety Warnings

⚠ WARNING: When using any nailer, all safety precautions, as outlined below, should be followed to avoid the risk of death or serious injury. Read and understand all instructions before operating the tool.

- **Hold tool by insulated gripping surfaces when performing an operation where the cutting tool may contact hidden wiring.** Contact with a "live" wire will make exposed metal parts of the tool "live" and shock the operator.
- **Actuating tool may result in flying debris, collation material, or dust which could harm operator's eyes.** Operator and others in work area **MUST** wear safety glasses with side shields. These safety glasses must conform to ANSI Z87.1 requirements (approved glasses have "Z87" printed or stamped on them). It is the employer's responsibility to enforce the use of eye protection equipment by the tool operator and other people in the work area. (Fig. A)
- **Always wear appropriate personal hearing and other protection during use.** Under some conditions and duration of use, noise from this product may contribute to hearing loss. (Fig. A)
- **Disconnect battery pack from the tool when not in use. Always remove battery pack and remove fasteners from magazine before leaving the area or passing the tool to another operator. Do not carry tool to another work area in which changing location involves the use of scaffoldings, stairs, ladders, and the like, with battery pack connected. Do not make adjustments, perform maintenance or clear jammed fasteners while battery is in place.**
- **Do not remove, tamper with, or otherwise cause the tool, trigger or trigger lock-off, to become inoperable.**

FIG. A



FIG. B



FIG. C



FIG. D

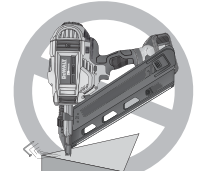

FIG. E

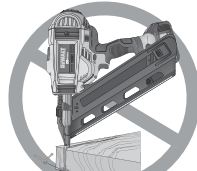

FIG. F

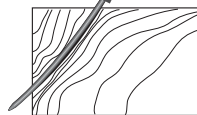
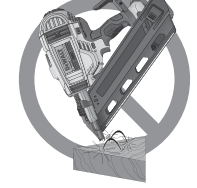

FIG. G



Do not tape or tie trigger in the ON position. Do not remove spring from contact trip. Make daily inspections for free movement of trigger. Uncontrolled discharge could result.

- **Inspect tool before use. Do not operate a tool if any portion of the tool, trigger, or trigger lock-off is inoperable, disconnected, altered, or not working properly.** Damaged parts or missing parts should be repaired or replaced before use. Refer to **Repairs**.
- **Do not alter or modify the tool in any way.**
- **Always assume that the tool contains fasteners.**
- **Do not point the tool at co-workers or yourself at any time. No horseplay! Work safe! Respect the tool as a working implement.** (Fig. B)
- **Keep bystanders, children, and visitors away while operating a power tool.** Distractions can cause you to lose control. When tool is not in use, it should be locked in a safe place, out of the reach of children.
- **Always use trigger lock-off when tool is not in immediate use.** Using the trigger lock-off will prevent accidental discharge. (Fig. M)
- **Do not overreach. Maintain proper footing and balance at all times.** Loss of balance may cause personal injury. (Fig. C)
- **Use the tool only for its intended use. Do not discharge fasteners into open air, concrete, stone, extremely hard woods, knots or any material too hard for the fastener to penetrate.** Do not use the body of the tool or top cap as a hammer. Discharged fastener may follow unexpected path and cause injury. (Figs. D, F)
- **Always keep fingers clear of contact trip to prevent injury from inadvertent release of the pusher** (Fig. H)
- **Refer to the Maintenance and Repairs sections for detailed information on the proper maintenance of the tool.**
- **Always operate the tool in a clean, lighted area.** Be sure the work surface is clear of any debris and be careful not to lose footing when working in elevated environments such as rooftops.
- **Do not drive fastener near edge of material.** The workpiece may split

FIG. H

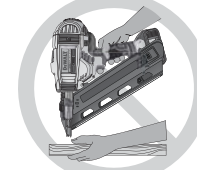

FIG. I



FIG. J

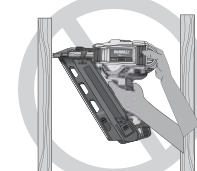

FIG. K



FIG. L



FIG. M

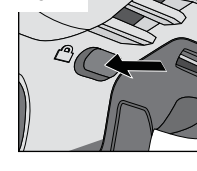

FIG. N



causing the nail to ricochet, injuring you or a co-worker. Be aware that the fastener may follow the grain of the wood (shiner), causing it to protrude unexpectedly from the side of the work material. Drive the chisel point of the fastener perpendicular to the grain to reduce risk of injury. (Figs. E, F)

- **Do not drive nails onto the heads of other fasteners or with the tool at too steep an angle.** Personal injury from strong recoil jammed nails, or ricocheted nails may result. (Fig. G)
- **Keep hands and body parts clear of immediate work area.** Hold workpiece with clamps when necessary to keep hands and body out of potential harm. Be sure the workpiece is properly secured before pressing the nailer against the material. The contact trip may cause the work material to shift unexpectedly. (Fig. H)
- **Do not use tool in the presence of flammable dust, gases or fumes.** The tool may produce a spark that could ignite gases causing a fire. Driving a nail into another nail may also cause a spark. (Fig. I)
- **Keep face and body parts away from back of the tool cap when working in restricted areas.** Sudden recoil can result in impact to the body, especially when nailing into hard or dense material. (Fig. J)
- **Grip tool firmly to maintain control while allowing tool to recoil away from work surface as fastener is driven.** In Bump mode if contact trip is allowed to recontact work surface before trigger is released an unwanted fastener will be fired.
- **Choice of triggering method is important.** Check the manual for triggering options.

BUMP/SEQUENTIAL SELECTOR SWITCH Sequential Action / (Fig. K)

- **When using the tool in sequential action, do not actuate the tool unless the tool is placed firmly against the workpiece.**

Bump Action // (Fig. L)

- **When using the tool in bump action, be careful of unintentional double fires resulting from tool recoil.** Unwanted fasteners may be driven if the contact trip is allowed to accidentally re-contact the work surface.

TO AVOID DOUBLE FIRES:

- Do not engage the tool against the work surface with a strong force.
- Allow the tool to recoil fully after each actuation.
- Use sequential action trigger.

- **When bump actuating the framing nailer, always keep tool in control.** Inaccurate placement of tool can result in misdirected discharge of a nail.
- **Be aware of material thickness when using nailer.** A protruding nail may cause injury.
- **DEPTH ADJUSTMENT: To reduce risk of serious injury from accidental actuation when attempting to adjust depth, ALWAYS;**
 - Remove battery pack.
 - Engage trigger lock-off (Fig. M).
 - Avoid contact with trigger during adjustments
- **Do not drive nails blindly into walls, floors or other work areas.** Fasteners driven into live electrical wires, plumbing, or other types of obstructions can result in injury. (Fig. N)
- **Stay alert, watch what you are doing and use common sense when operating a power tool. Do not use tool while tired or under the influence of drugs, alcohol, or medication.** A moment of inattention while operating power tools may result in serious personal injury.

▲ WARNING: Some dust created by power sanding, sawing, grinding, drilling, and other construction activities contains chemicals known to the State of California to cause cancer, birth defects or other reproductive harm. Some examples of these chemicals are:

- lead from lead-based paints,
- crystalline silica from bricks and cement and other masonry products, and
- arsenic and chromium from chemically-treated lumber.

Your risk from these exposures varies, depending on how often you do this type of work. To reduce your exposure to these chemicals: work in a well ventilated area, and work with approved safety equipment, such as those dust masks that are specially designed to filter out microscopic particles.

▲ WARNING: Use of this tool can generate and/or disburse dust, which may cause serious and permanent respiratory or other injury. Always use NIOSH/OSHA approved respiratory protection appropriate for the dust exposure. Direct particles away from face and body.

▲ WARNING: ALWAYS USE SAFETY GLASSES. Everyday eyeglasses are NOT safety glasses. Also use face or dust mask if operation is dusty. ALWAYS WEAR CERTIFIED SAFETY EQUIPMENT:

- ANSI Z87.1 eye protection (CAN/CSA Z94.3),
- ANSI S12.6 (S3.19) hearing protection,
- NIOSH/OSHA/MSHA respiratory protection.

▲ CAUTION: When not in use, place tool on its side on a stable surface where it will not cause a tripping or falling hazard. Some tools with large battery packs will stand upright on the battery pack but may be easily knocked over.

- The label on your tool may include the following symbols. The symbols and their definitions are as follows:

V..... volts	A..... amperes
Hz..... hertz	W..... watts
min minutes	~ alternating current
== direct current	⎓ alternating or direct current
⚠ Class I Construction (grounded)	n ₀ no load speed
□ Class II Construction terminal (double insulated)	n rated speed
.../min per minute	⊕ earthing
IPM..... impacts per minute	▲..... safety alert symbol
SPM..... strokes per minute	BPM..... beats per minute
	RPM..... revolutions per minute
	sfpM surface feet per minute

Important Safety Instructions for All Battery Packs

When ordering replacement battery packs, be sure to include the catalog number and voltage. Consult the chart at the end of this manual for compatibility of chargers and battery packs.

The battery pack is not fully charged out of the carton. Before using the battery pack and charger, read the safety instructions below and then follow charging procedures outlined.

READ ALL INSTRUCTIONS

- **Do not charge or use the battery pack in explosive atmospheres, such as in the presence of flammable liquids, gases or dust.** Inserting or removing the battery pack from the charger may ignite the dust or fumes.
- **NEVER force the battery pack into the charger. DO NOT modify the battery pack in any way to fit into a non-compatible charger as battery pack may rupture causing serious personal injury.** Consult the chart at the end of this manual for compatibility of batteries and chargers.
- Charge the battery packs only in designated DEWALT chargers.
- **DO NOT splash or immerse in water or other liquids.**
- **Do not store or use the tool and battery pack in locations where the temperature may reach or exceed 105 °F (40 °C) (such as outside sheds or metal buildings in summer).** For best life store battery packs in a cool, dry location.

NOTE: Do not store the battery packs in a tool with the trigger switch locked on. Never tape the trigger switch in the ON position.

▲ WARNING: Fire hazard. Never attempt to open the battery pack for any reason. If the battery pack case is cracked or damaged, do not insert into the charger. Do not crush, drop or damage the battery pack. Do not use a battery pack or charger that has received a sharp blow, been dropped, run over or damaged in any way (e.g., pierced with a nail, hit with a hammer, stepped on). Damaged battery packs should be returned to the service center for recycling.

▲ WARNING: Fire hazard. Do not store or carry the battery pack so that metal objects can contact exposed battery terminals. For example, do not place the battery pack in aprons, pockets, tool boxes, product kit boxes, drawers, etc., with loose nails, screws, keys, etc. **Transporting batteries can possibly cause fires if the battery terminals inadvertently come in contact with conductive materials such as keys, coins, hand tools and the like.** The US Department of Transportation Hazardous Material Regulations (HMR) actually prohibit transporting batteries in commerce or on airplanes (e.g., packed in suitcases and carry-on luggage) UNLESS they are properly protected from short circuits. So when transporting individual battery packs, make sure that the battery terminals are protected and well insulated from materials that could contact them and cause a short circuit.

SPECIFIC SAFETY INSTRUCTIONS FOR LITHIUM ION (Li-Ion)

- **Do not incinerate the battery pack even if it is severely damaged or is completely worn out.** The battery pack can explode in a fire. Toxic fumes and materials are created when lithium ion battery packs are burned.
- **If battery contents come into contact with the skin, immediately wash area with mild soap and water.** If battery liquid gets into the eye, rinse water over the open eye for 15 minutes or until irritation ceases. If medical attention is needed, the battery electrolyte is composed of a mixture of liquid organic carbonates and lithium salts.
- **Contents of opened battery cells may cause respiratory irritation.** Provide fresh air. If symptoms persist, seek medical attention.

▲ WARNING: Burn hazard. Battery liquid may be flammable if exposed to spark or flame.

The RBRC™ Seal

The RBRC™ (Rechargeable Battery Recycling Corporation) Seal on the nickel cadmium, nickel metal hydride or lithium ion batteries (or battery packs) indicate that the costs to recycle these batteries (or battery packs) at the end of their useful life have already been paid by DEWALT. In some areas, it is illegal to place spent nickel cadmium, nickel metal hydride or lithium ion batteries in the trash or municipal solid waste stream and the RBRC program provides an environmentally conscious alternative.



RBRC™, in cooperation with DEWALT and other battery users, has established programs in the United States and Canada to facilitate the collection of spent nickel cadmium, nickel metal hydride or lithium ion batteries. Help protect our environment and conserve natural resources by returning the spent nickel cadmium, nickel metal hydride or lithium ion batteries to an authorized DEWALT service center or to your local retailer for recycling. You may also contact your local recycling center for information on where to drop off the spent battery.

RBRC™ is a registered trademark of the Rechargeable Battery Recycling Corporation.

Important Safety Instructions for All Battery Chargers

SAVE THESE INSTRUCTIONS: This manual contains important safety and operating instructions for battery chargers.

- Before using the charger, read all instructions and cautionary markings on the charger, battery pack and product using the battery pack.

⚠ WARNING: Shock hazard. Do not allow any liquid to get inside the charger. Electric shock may result.

⚠ CAUTION: Burn hazard. To reduce the risk of injury, charge only DEWALT rechargeable battery packs. Other types of batteries may overheat and burst resulting in personal injury and property damage.

NOTICE: Under certain conditions, with the charger plugged into the power supply, the charger can be shorted by foreign material. Foreign materials of a conductive nature, such as, but not limited to, grinding dust, metal chips, steel wool, aluminum foil or any buildup of metallic particles should be kept away from the charger cavities. Always unplug the charger from the power supply when there is no battery pack in the cavity. Unplug the charger before attempting to clean.

- **DO NOT attempt to charge the battery pack with any chargers other than the ones in this manual.** The charger and battery pack are specifically designed to work together.
- **These chargers are not intended for any uses other than charging DEWALT rechargeable batteries.** Any other uses may result in risk of fire, electric shock or electrocution.
- **Do not expose the charger to rain or snow.**
- **Pull by the plug rather than the cord when disconnecting the charger.** This will reduce the risk of damage to the electric plug and cord.
- **Make sure that the cord is located so that it will not be stepped on, tripped over or otherwise subjected to damage or stress.**
- **Do not use an extension cord unless it is absolutely necessary.** Use of improper extension cord could result in risk of fire, electric shock or electrocution.
- **When operating a charger outdoors, always provide a dry location and use an extension cord suitable for outdoor use.** Use of a cord suitable for outdoor use reduces the risk of electric shock.
- **An extension cord must have adequate wire size (AWG or American Wire Gauge) for safety.** The smaller the gauge number of the wire, the greater the capacity of the cable, that is, 16 gauge has more capacity than 18 gauge. An undersized cord will cause a drop in line voltage resulting in loss of power and overheating. When using more than one extension to make up the total length, be sure each individual extension contains at least the minimum wire size. The following table shows the correct size to use depending on cord length and nameplate ampere rating. If in doubt, use the next heavier gauge. The lower the gauge number, the heavier the cord.

Ampere Rating		Minimum Gauge for Cord Sets				
		Volts	Total Length of Cord in Feet (meters)			
			120V	25 (7.6)	50 (15.2)	100 (30.5)
More Than	Not More Than	240V	50 (15.2)	100 (30.5)	200 (61.0)	300 (91.4)
		AWG				
0	6		18	16	16	14
6	10		18	16	14	12
10	12		16	16	14	12
12	16		14	12	Not Recommended	

- **Do not place any object on top of the charger or place the charger on a soft surface that might block the ventilation slots and result in excessive internal heat.** Place the charger in a position away from any heat source. The charger is ventilated through slots in the top and the bottom of the housing.
- **Do not operate the charger with a damaged cord or plug.**
- **Do not operate the charger if it has received a sharp blow, been dropped or otherwise damaged in any way.** Take it to an authorized service center.
- **Do not disassemble the charger; take it to an authorized service center when service or repair is required.** Incorrect reassembly may result in a risk of electric shock, electrocution or fire.
- **Disconnect the charger from the outlet before attempting any cleaning. This will reduce the risk of electric shock.** Removing the battery pack will not reduce this risk.
- **NEVER attempt to connect 2 chargers together.**
- **The charger is designed to operate on standard 120V household electrical power. Do not attempt to use it on any other voltage.** This does not apply to the vehicular charger.

Chargers

Your tool uses a DEWALT charger. Be sure to read all safety instructions before using your charger. Consult the chart at the end of this manual for compatibility of chargers and battery packs.

Charging Procedure (Fig.2)

1. Plug the charger into an appropriate outlet before inserting the battery pack.
2. Insert the battery pack (L) into the charger, as shown in Figure 2, making sure the pack is fully seated in charger. The red (charging) light will blink continuously, indicating that the charging process has started.
3. The completion of charge will be indicated by the red light remaining ON continuously. The pack is fully charged and may be used at this time or left in the charger.

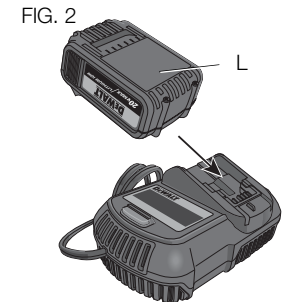

Indicator Light Operation

	PACK CHARGING	— — — — —
	PACK CHARGED	—————
	HOT/COLD DELAY	— ● — ● — ● — ● — ●
	PROBLEM PACK OR CHARGER	● ● ● ● ● ● ● ●
	PROBLEM POWERLINE	● ● ● ● ● ● ● ●

CHARGE INDICATORS

This charger is designed to detect certain problems that can arise. Problems are indicated by the red light flashing at a fast rate. If this occurs, re-insert the battery pack into the charger. If the problem persists, try a different battery pack to determine if the charger is working properly. If the new pack charges correctly, then the original pack is defective and should be returned to a service center or other collection site for recycling. If the new battery pack elicits the same trouble indication as the original, have the charger and the battery pack tested at an authorized service center.

HOT/COLD DELAY

This charger has a hot/cold delay feature: when the charger detects a battery that is hot, it automatically starts a delay, suspending charging until the battery has cooled. After the battery has cooled, the charger automatically switches to the pack charging mode. This feature ensures maximum battery life. The red light flashes long, then short while in the hot/cold delay mode.

LEAVING THE BATTERY PACK IN THE CHARGER

The charger and battery pack can be left connected with the charge indicator showing Pack Charged.

WEAK BATTERY PACKS: Weak batteries will continue to function but should not be expected to perform as much work.

FAULTY BATTERY PACKS: This charger will not charge a faulty battery pack. The charger will indicate faulty battery pack by refusing to light or by displaying problem pack or charger.

NOTE: This could also mean a problem with a charger.

PROBLEM POWER LINE

Some chargers have a Problem Powerline indicator. When the charger is used with some portable power sources such as generators or sources that convert DC to AC, the charger may temporarily suspend operation, flashing the red light with two fast blinks followed by a pause. This indicates the power source is out of limits.

Important Charging Notes

1. Longest life and best performance can be obtained if the battery pack is charged when the air temperature is between 65 °F and 75 °F (18°–24 °C). DO NOT charge the battery pack in an air temperature below +40 °F (+4.5 °C), or above +105 °F (+40.5 °C). This is important and will prevent serious damage to the battery pack.
2. The charger and battery pack may become warm to the touch while charging. This is a normal condition, and does not indicate a problem. To facilitate the cooling of the battery pack after use, avoid placing the charger or battery pack in a warm environment such as in a metal shed or an uninsulated trailer.
3. A cold battery pack will charge at about half the rate of a warm battery pack. The battery pack will charge at that slower rate throughout the entire charging cycle and will not return to maximum charge rate even if the battery pack warms.
4. If the battery pack does not charge properly:
 - a. Check operation of receptacle by plugging in a lamp or other appliance;
 - b. Check to see if receptacle is connected to a light switch which turns power off when you turn out the lights;
 - c. Move the charger and battery pack to a location where the surrounding air temperature is approximately 65 °F–75 °F (18°–24 °C);
 - d. If charging problems persist, take the tool, battery pack and charger to your local service center.
5. The battery pack should be recharged when it fails to produce sufficient power on jobs which were easily done previously. DO NOT CONTINUE to use under these conditions. Follow the charging procedure. You may also charge a partially used pack whenever you desire with no adverse effect on the battery pack.

6. Foreign materials of a conductive nature such as, but not limited to, grinding dust, metal chips, steel wool, aluminum foil, or any buildup of metallic particles should be kept away from charger cavities. Always unplug the charger from the power supply when there is no battery pack in the cavity. Unplug the charger before attempting to clean.

7. Do not freeze or immerse the charger in water or any other liquid.

⚠WARNING: Shock hazard. Don't allow any liquid to get inside the charger. Electric shock may result.

⚠WARNING: Burn hazard. Do not submerge the battery pack in any liquid or allow any liquid to enter the battery pack. Never attempt to open the battery pack for any reason. If the plastic housing of the battery pack breaks or cracks, return to a service center for recycling.

Storage Recommendations

1. The best storage place is one that is cool and dry, away from direct sunlight and excess heat or cold.
2. For long storage, it is recommended to store a fully charged battery pack in a cool dry place out of the charger for optimal results.

NOTE: Battery packs should not be stored completely depleted of charge. The battery pack will need to be recharged before use.

SAVE THESE INSTRUCTIONS FOR FUTURE USE

COMPONENTS (FIG. 1)

⚠WARNING: Lock the trigger in the off position, disconnect battery pack from tool and remove nail strips from magazine before making adjustments or personal injury may result.

Refer to Figure 1 at the beginning of this manual for a complete list of components.

INTENDED USE

The DCN690 cordless framing nailer has been designed for driving nails into wooden workpieces.

DO NOT use under wet conditions or in presence of flammable liquids or gases.

This cordless framing nailer is a professional power tool. **DO NOT** let children come into contact with the tool. Supervision is required when inexperienced operators use this tool.

OPERATION

⚠WARNING: Read the section titled **Nailer Safety Warnings** at the beginning of this manual. Always wear eye and ear protection when operating this tool. Keep the nailer pointed away from yourself and others. For safe operation, complete the following procedures and checks before each use of the nailer.

1. Wear proper eye, hearing and respiratory protection.
2. Remove battery pack from tool.
3. Lock the pusher in the back position and remove all nail strips from the magazine.
4. Check for smooth and proper operation of contact trip and pusher assemblies. Do not use tool if either assembly is not functioning properly. **NEVER** use a tool that has the contact trip restrained in the up position.
5. **NEVER** use a tool that has damaged parts.

⚠WARNING: To reduce the risk of personal injury, disconnect battery pack from tool before performing maintenance, clearing a jammed nails, leaving work area, moving tool to another location or handing the tool to another person.

Installing and Removing the Battery Pack (Fig. 3)

NOTE: For best results, make sure your battery pack is fully charged.

To install the battery pack (L) into the tool handle, align the battery pack with the rails inside the tool's handle and slide it into the handle until the battery pack is firmly seated in the tool and ensure that it does not disengage.

To remove the battery pack from the tool, press the release button (N) and firmly pull the battery pack out of the tool handle. Insert it into the charger as described in the charger section of this manual.

NOTICE: Do not store tool with battery pack installed. To prevent damage to the pack and to ensure best battery life, store battery packs out of the tool or charger in a cool, dry location.

FUEL GAUGE BATTERY PACKS (FIG. 4)

Some DEWALT battery packs include a fuel gauge which consists of three green LED lights that indicate the level of charge remaining in the battery pack.

To actuate the fuel gauge, press and hold the fuel gauge button (O). A combination of the three green LED lights will illuminate designating the level of charge left. When the level of charge in the battery is below the usable limit, the fuel gauge will not illuminate and the battery will need to be recharged.

NOTE: The fuel gauge is only an indication of the charge left on the battery pack. It does not indicate tool functionality and is subject to variation based on product components, temperature and end-user application.

For more information regarding fuel gauge battery packs, please call 1-800-4-DEWALT (1-800-433-9258) or visit our website www.DEWALT.com.

Mode Selection

▲WARNING: Always wear proper eye [ANSI Z87.1 (CAN/CSA Z94.3)] and ANSI S12.6 (S3.19) hearing protection when operating tool.

The DEWALT cordless nailers are assembled in accordance with the ANSI Standard SNT-101-2002. The framing nailer is capable of firing nails using bump actuation or sequential actuation. If you would like to have the bump actuation mode disabled, have the tool serviced by an authorized DEWALT service center. Before operating this tool, look at the selector switch to determine the actuation mode. Read all instructions before selecting actuation mode.

▲WARNING: Keep fingers AWAY from trigger when not driving nails to avoid accidental firing. **NEVER** carry tool with finger on trigger. In bump mode tool will fire a nail if contact trip is bumped while trigger is depressed.

SEQUENTIAL ACTION ↗ (FIG. 5)

Use sequential action for intermittent nailing where very careful and accurate placement and depth control is desired. The sequential actuation mode provides the maximum delivery of power for driving the longest nails.

To operate the nailer in sequential action mode:

1. Slide the selector switch to the left, as shown in Figure 5.
2. Fully depress nosepiece against the work surface (motor will start).
3. Pull trigger (nail will drive into work surface).
4. Release trigger.
5. Lift nosepiece off work surface.
6. Repeat steps 2 through 4 for next application.

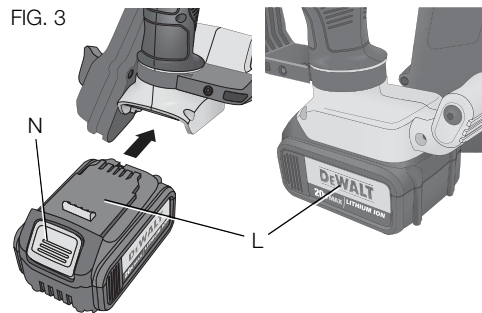

FIG. 3

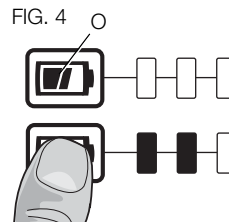

FIG. 4

NOTICE: The contact trip needs to be depressed followed by a trigger pull for each nail followed by a release of both the contact trip and trigger after each nail.

BUMP ACTION ↗ (FIG. 6)

Bump action is intended for rapid nailing on flat, stationary surfaces and typically most effective for applications that require driving shorter nails.

When using bump action, two methods are available: **place actuation** and **bump actuation**.

Slide the selector switch to the right, as shown in Figure 6.

To operate the tool using the PLACE ACTUATION method:

▲WARNING: A nail will fire each time the trigger is depressed as long as the contact trip remains depressed.

1. Depress the contact trip against the work surface.
2. Depress the trigger.

To operate the tool using the BUMP ACTUATION method:

1. Depress the trigger.
2. Push the contact trip against the work surface. As long as the trigger is depressed, the tool will fire a nail every time the contact trip is depressed. This allows the user to drive multiple nails in sequence.

▲WARNING: Do not keep trigger depressed when tool is not in use. Keep the trigger lock-off in the locked position when the tool is not in use.

▲WARNING: When the tool's motor is running, the next actuation, pulling the trigger or depressing the contact trip, will cause a nail to fire.

DRY FIRE LOCK OUT

The nailer is equipped with a dry fire lockout which prevents the tool from actuating when the magazine is nearly empty. When approximately 7 to 9 nails remain in the magazine, the tool ceases to operate. Refer to **Loading the Tool** to reload a stick of collated nails.

Speed Selection (Fig. 1, 7)

(DCN692 ONLY)

This nailer is equipped with a dual speed selection switch (M) located on the foot.

- For shorter nails, select speed 1 by setting the switch to the left most position.
- For longer nails and more rigorous applications, select speed 2 by setting the switch to the right most position.

In the event that nails are not driving to depth in speed setting 1, you may have to switch to speed setting 2 for additional driving power.

NOTICE: Firing nails under 3-inches in length using Speed Setting 2 will cause excessive wear to your tool and may result in early failures.

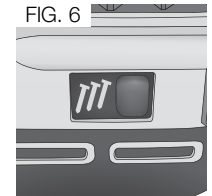

FIG. 6

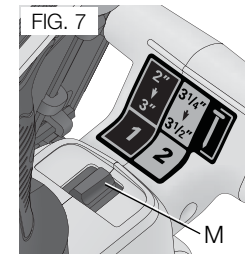

FIG. 7

Suggested Speed Settings

Application	Typical Nail Length	Speed Setting
Framing & Decking	3 1/4", 3 1/2" (8.255 cm, 8.89 cm)	2
General Framing	3" (7.62 cm)	1
Sheathing	2 3/8" (6,03 cm)	1
Fencing	2" (5,08 cm)	1

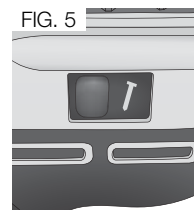

FIG. 5

Preparing the Tool

NOTICE: NEVER spray or in any other way apply lubricants or cleaning solvents inside the tool. This can seriously affect the life and performance of the tool.

NOTE: The battery pack is not fully charged out of the carton. Follow instructions outlined (refer to **Charging Procedures**).



1. Read the Nailer Safety Warnings section of this manual.
2. Wear eye and ear protection.
3. Remove battery from tool.
4. Ensure magazine is empty of all fasteners.
5. Check for smooth and proper operation of contact trip and pusher assemblies. Do not use tool if either assembly is not functioning properly. **NEVER** use a tool that has the contact trip restrained in the actuated position.
6. Keep tool pointed away from yourself and others.
7. Insert fully charged battery pack.

Using the Trigger Lock-off (Fig. 8)

⚠WARNING: To reduce the risk of serious personal injury, do not keep trigger depressed when tool is not in use. Keep the trigger lock-off switch LOCKED (Fig. 8) when the tool is not in use.

⚠WARNING: To reduce the risk of serious personal injury, lock off trigger, disconnect battery pack from tool and remove nails from magazine before making adjustments.

Each DEWALT nailer is equipped with a trigger lock-off (B) which when pushed to the right as shown in Figure 8, prevents the tool from firing a nail by locking the trigger and bypassing power to the motor.

When the trigger lock-off is pressed to the left, the tool will be fully operational. The trigger lock-off should always be locked off (Fig. 8) whenever any adjustments are made or when tool is not in immediate use.

NOTICE: Do not store tool with battery pack installed. To prevent damage to the pack and to ensure best battery life, store battery packs out of the tool or charger in a cool, dry location.

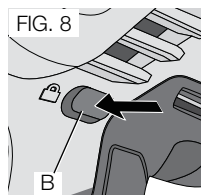

Loading the Tool (Fig. 9)

⚠WARNING: Keep the tool pointed away from yourself and others.

⚠WARNING: Never load nails with the contact trip or trigger activated.

⚠WARNING: Always remove battery pack before loading or unloading nails.

⚠CAUTION: Keep fingers clear of pusher latch track to prevent injury.

⚠WARNING: The trigger lock-off should always be engaged whenever any adjustments are made or when tool is not in use.

1. Turn the nailer upside down.
2. Slide the spring-loaded pusher latch (H) to the base of the magazine to lock it into place.
3. Drop nail strips into the loading slot of the magazine, making sure the nail heads align correctly with the slot opening. (Refer to **Nail Specifications** to determine compatible size.)
4. Keeping fingers clear of the track, close the magazine by releasing the pusher latch. Carefully allow the latch to slide forward and engage the nail strip.



UNLOADING THE TOOL

⚠WARNING: The trigger lock-off should always be locked off whenever any adjustments are made or when tool is not in use.

1. Slide the spring-loaded pusher latch to the base of the magazine to lock it into place.

2. Tip the tool up until the fastener strip slides freely out of the magazine.

3. With battery removed, check the nosepiece to verify there are no nails remaining.

NOTE: The tool is equipped with a magnet in the nose area for improved tool performance. When unloading, always verify that the small sticks of nails are not held to the magnetized nose piece.

Adjusting Depth (Fig. 10)

The depth that the nail is driven can be adjusted using the depth adjustment wheel (C) on the nose of the tool.

⚠WARNING: To reduce risk of serious injury from accidental actuation when attempting to adjust depth, ALWAYS:

- Remove battery pack.
- Engage trigger lock-off.
- Always point the nose of the nailer away from you.
- Avoid contact with trigger during adjustments.

1. To drive the nail shallower, rotate the depth adjustment wheel (C) to the left, toward the shallow nail icon.
2. To drive a nail deeper, rotate the depth adjustment wheel (C) to the right, toward the deeper nail icon.

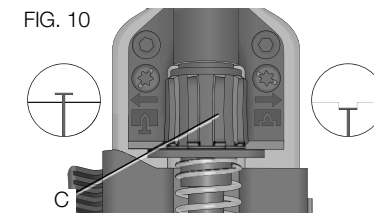

Non-mar Tip (Fig. 11)

When using this tool on softer materials that you do not want to mark, such as wood cladding, use the plastic non-mar tip (P) over the contact trip (F).

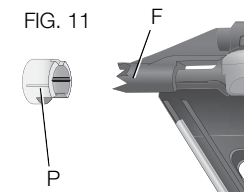

LED Indicator (Fig. 1)

There is an low battery and jam/stall indicator light (D) located on the back of the tool just below the back cap.

		LOW BATTERY Replace battery with a charged pack.
		HOT PACK Let the battery cool or replace it with a cool pack.
		JAM/STALL CONDITION Rotate the stall release lever to release. Refer to Stall Release .
		HOT TOOL Let the tool cool down before continuing use.
	 or any other combination.	ERROR Reset tool by removing and reinserting battery pack or cycling trigger lock off. If error code persist, take tool to an authorized DEWALT service center.

Stall Release (Fig. 12)

If the nailer is used in harder wood where all available energy in the motor is used to drive a fastener, the tool may stall. The driver blade will not complete the drive cycle and the jam/stall indicator will flash. Rotate the stall release lever (E) on the tool and the mechanism will release. **NOTE:** The tool will disable itself and not reset until the battery pack has been removed and reinserted. If the driver blade does not automatically return to the home position, proceed to **Clearing a Jammed Nail**. If the unit continues to stall please review the material and fastener length to be sure that it is not too rigorous an application.

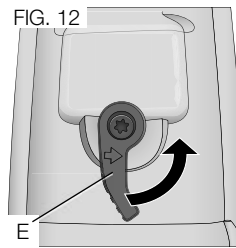

Clearing a Jammed Nail (Fig. 1, 13)

⚠WARNING: To reduce the risk of serious personal injury, disconnect battery pack from tool before making any adjustments, changing accessories, servicing, or moving the tool. Such preventative safety measures reduce the risk of starting the tool accidentally.

If a nail becomes jammed in the nosepiece, keep the tool pointed away from you and follow these instructions to clear:

1. Remove battery pack from tool and engage trigger lock-off.
2. Slide the spring-loaded pusher latch to the base of the magazine to lock it into place and unload nail strip.
3. Using the hex tool (K) provided, loosen the two hex bolts (Q) at the top of the magazine.
4. Rotate the magazine (G) forward.
5. Remove jammed/bent nail, using pliers if necessary.
6. If the driver blade is in the down position, rotate the stall release lever on the top of the nailer.

NOTE: If the driver blade will not reset after rotating the stall release lever, manually resetting the blade with a long screw driver may be necessary.

7. Rotate the magazine back into position under the nose of the tool and tighten hex bolts.
8. Reinsert battery pack.

NOTE: The tool will disable itself and not reset until the battery pack has been removed and reinserted.

9. Reinsert nails into magazine (refer to **Loading the Tool**).
10. Release the pusher latch.

11. Disengage the trigger lock-off when ready to continue nailing.

NOTE: Should nails jam frequently or the driver blade continually fail to reset, have tool serviced by an authorized DEWALT service center.

Cold Weather Operation

When operating tools at temperatures below freezing:

1. Keep tool as warm as possible prior to use.
2. Actuate the tool 10 or 15 times into scrap lumber before using.

Hot Weather Operation

Tool should operate normally. However, keep tool out of direct sunlight as excessive heat can deteriorate bumpers and other rubber parts resulting in increased maintenance.

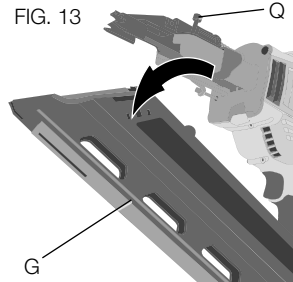

Rotating Rafter Hook (Fig. 14)

⚠WARNING: Never use hook to hang tool from belt or other clothing unless tool is in sequential action mode.

⚠WARNING: Remove nails from magazine before making any adjustments or servicing this tool. Failure to do so may result in serious injury.

⚠CAUTION: When not in use, place tool on its side on a stable surface where it will not cause a tripping or falling hazard.

⚠CAUTION: Some tools with large battery packs will stand upright on the battery pack but may be easily knocked over.

The DEWALT cordless nailer includes a rotating rafter hook (J) and can be easily positioned to the left or right of the tool to accommodate left- or right-handed users.

If use of the hook is not desired at all, it can be rotated to the front or back of the handle base.

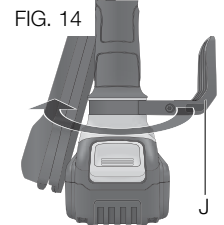

MAINTENANCE

⚠WARNING: To reduce the risk of serious personal injury, disconnect battery pack from tool before making any adjustments, changing accessories, servicing, or moving the tool. Such preventative safety measures reduce the risk of starting the tool accidentally.

Daily Maintenance Chart

ACTION	Clean magazine, pusher, and contact trip mechanism.
WHY	Permits smooth operation of magazine, reduces wear, and prevents jams.
HOW	Blowing off the tool with compressed air is the most effective way to clean the tool. The use of oils, lubricants periodically or solvents is not recommended as they tend to attract debris and/or damage the plastic parts of the tool.
ACTION	Before each use, check to ensure all screws and fasteners are tight and undamaged.
WHY	Prevents jams and premature failure of tool parts.
HOW	Tighten loose screws using the appropriate hex wrench or screwdriver.

Cleaning

⚠WARNING: Blow dirt and dust out of all air vents with clean, dry air at least once a week. To minimize the risk of eye injury, always wear ANSI Z87.1 approved eye protection when performing this.

NOTICE: When cleaning, use only a damp cloth on plastic parts. Many household cleaners contain chemicals which could seriously damage plastic parts. Also, do not use gasoline, turpentine, lacquer or paint thinner, dry cleaning fluids or similar products which may seriously damage plastic parts. Never let any liquid get inside the tool; never immerse any part of the tool into a liquid.

CHARGER CLEANING INSTRUCTIONS

⚠WARNING: Shock hazard. Disconnect the charger from the AC outlet before cleaning. Dirt and grease may be removed from the exterior of the charger using a cloth or soft non-metallic brush. Do not use water or any cleaning solutions.

Lubrication

NOTICE: NEVER spray or in any other way apply lubricants or cleaning solvents inside the tool. This can seriously affect the life and performance of the tool.

DEWALT tools are properly lubricated at the factory and are ready for use. However, it is recommended that, once a year, you take or send the tool to a certified service center for a thorough cleaning and inspection.



Accessories

⚠ WARNING: Since accessories, other than those offered by DEWALT, have not been tested with this product, use of such accessories with this tool could be hazardous. To reduce the risk of injury, only DEWALT, recommended accessories should be used with this product.

DCN6901 RETURN SPRING REPLACEMENT KIT

⚠ WARNING: For your own safety, read the tool instruction manual before using any accessory. Failure to heed these warnings may result in serious personal injury and damage to the tool and the accessory. When servicing this tool, use only identical replacement parts.

NOTICE: All the mechanical parts of the spring replacement kit are shown for convenience and verification of inclusion. The kit also contains a packet of Loctite adhesive for use in step 8. Refer to Fig. 20.

TO CHANGE BROKEN RETURN SPRINGS:

NOTE: Springs should be replaced as a pair, using only the correct DEWALT accessory spring replacement kit.

- Using the key (K) provided, loosen the two screws (aa) on either side of the unit. Refer to Figure 15.
- Remove the return system (bb) from the unit. Refer to Figure 16.

FIG. 15

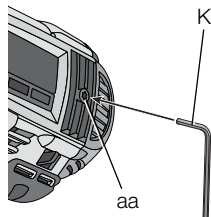
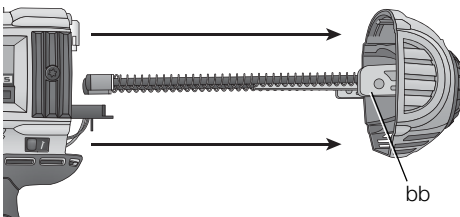

FIG. 16



- Slide the spring rail clip (cc) off of the spring rail (dd). Refer to figure 17.
- Twist and remove the Spring Bumper (ee) and remove the washer (ff) and return spring (gg). Refer to figure 18.
- Mount the new return spring and washer on to the spring rail (dd). While compressing the spring with the washer near the opposite end of the rail, twist on the new spring bumper until it is past the groove (hh) for the spring rail clip.
- Mount the new spring rail clip securely and position the bumper against the clip.
- Repeat steps 3–6 for the second spring.

NOTE: Check the return of the profile by sliding the profile up the spring rail and letting it go. It should return due to the force from the springs.

- Slide the return system (bb) back into the unit. It is important to try the alignment of the profile and the flywheel before screwing the return system back on to the unit. This can be done by connecting a battery and pushing then releasing the nose of the unit against a bench or hard surface. This will start the motor spinning.

NOTE: When the profile and the flywheel are correctly aligned, you will hear the motor coast back down from full speed. If the profile and the flywheel are not correctly aligned, the motor it may not start up, may slow down much faster than normal along with a loud grinding noise from the unit. If this happens remove and reseal the return system.

- Once the return system is correctly seated, open the provided sachet of Loctite®* and apply a small amount on the thread of the two screws (aa) and remount the two screws using the key and tighten securely.

FIG. 17

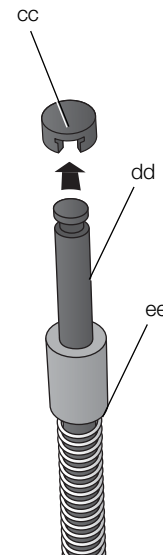

FIG. 18

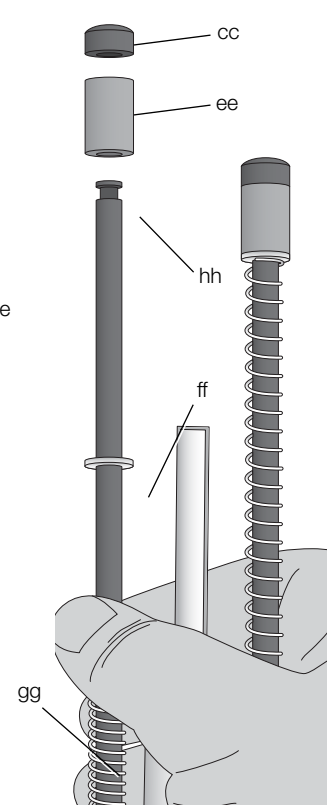

FIG. 19

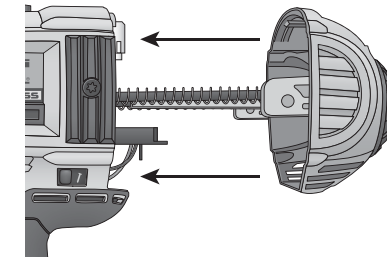
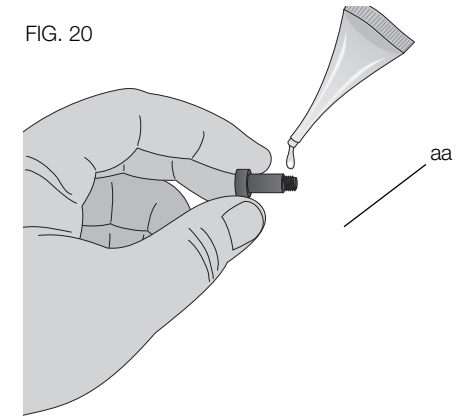

FIG. 20



⚠ WARNING: Always test the unit by firing short nails in to soft wood, to ensure that the tool is working properly. If tool does not operate properly, contact a recognized DEWALT service center immediately.

⚠ WARNING: LOCTITE® SACHET CONTENTS MAY IRRITATE EYES, SKIN, AND RESPIRATORY SYSTEM. USE ENTIRE CONTENTS ON OPENING. Do not breath fumes. Do not get in eyes or on skin or clothing. Use only in a well ventilated area. Keep out of reach of children. **FIRST AID**

TREATMENT: Contains polyglycol dimethacrylate, polyglycol oleate, propylene glycol, titanium dioxide, and cumene hydroperoxide. If swallowed, call a Poison Control Center or doctor immediately. Do not induce vomiting. If breathed in move person to fresh air. If in eyes, rinse with water for 15 minutes. Obtain medical attention. If on skin, rinse well with water. If on clothes, remove clothes.

*Loctite® is a registered trademark of Henkel Corp.

Recommended accessories for use with your tool are available at extra cost from your local dealer or authorized service center. If you need assistance in locating any accessory, please contact DEWALT Industrial Tool Co., 701 East Joppa Road, Baltimore, MD 21286, call 1-800-4-DEWALT (1-800-433-9258) or visit our website www.DEWALT.com.

Repairs

The charger and battery pack are not serviceable.

To assure product SAFETY and RELIABILITY, repairs, maintenance and adjustment should be performed by a DEWALT factory service center, a DEWALT authorized service center or other qualified service personnel. Always use identical replacement parts. Refer to the **Troubleshooting Guide** at the end of this section.

Register Online

Thank you for your purchase. Register your product now for:

- **WARRANTY SERVICE:** Registering your product will help you obtain more efficient warranty service in case there is a problem with your product.
- **CONFIRMATION OF OWNERSHIP:** In case of an insurance loss, such as fire, flood or theft, your registration of ownership will serve as your proof of purchase.
- **FOR YOUR SAFETY:** Registering your product will allow us to contact you in the unlikely event a safety notification is required.

Register online at www.DEWALT.com/register.

Three Year Limited Warranty

DEWALT will repair, without charge, any defects due to faulty materials or workmanship for three years from the date of purchase. This warranty does not cover part failure due to normal wear or tool abuse. For further detail of warranty coverage and warranty repair information, visit www.DEWALT.com or call 1-800-4-DEWALT (1-800-433-9258). This warranty does not apply to accessories or damage caused where repairs have been made or attempted by others. This warranty gives you specific legal rights and you may have other rights which vary in certain states or provinces.

In addition to the warranty, DEWALT tools are covered by our:

1 YEAR FREE SERVICE

DEWALT will maintain the tool and replace worn parts caused by normal use for free any time during the first year after purchase. Nailer wear items such as return springs, driver blades, and bumpers are not covered.

2 YEARS FREE SERVICE ON DEWALT BATTERY PACKS

DC9071, DC9091, DC9096, DC9280, DC9360, DC9180, DCB120 and DCB201

3 YEARS FREE SERVICE ON DEWALT BATTERY PACKS

DCB200

DEWALT BATTERY PACKS

Product warranty voided if the battery pack is tampered with in any way. DEWALT is not responsible for any injury caused by tampering and may prosecute warranty fraud to the fullest extent permitted by law.

90 DAY MONEY BACK GUARANTEE

If you are not completely satisfied with the performance of your DEWALT Power Tool, Laser, or Nailer for any reason, you can return it within 90 days from the date of purchase with a receipt for a full refund – no questions asked.

LATIN AMERICA: This warranty does not apply to products sold in Latin America. For products sold in Latin America, see country specific warranty information contained in the packaging, call the local company or see website for warranty information.

FREE WARNING LABEL REPLACEMENT: If your warning labels become illegible or are missing, call 1-800-4-DEWALT (1-800-433-9258) for a free replacement.

DCNXXX	20V (Max) CORDLESS PAPER-TAPE FASTENER ANGLE	DIAMETER	SPEED 1 - LENGTH	SPEED 2 - LENGTH
FRAMING NAILER	30°-34°	.113" - .131" (2.8 - 3.3 mm)	2" - 3" (50-75 mm)	3 1/4" - 3 1/2" (82-90 mm)

WARNING AVERTISSEMENT TO REDUCE THE RISK OF INJURY, USER MUST READ INSTRUCTION MANUAL. OPERATORS AND OTHERS IN WORK AREA MUST WEAR ANSI Z87.1 SAFETY GLASSES WITH SIDE SHIELDS, KEEP FINGERS AWAY FROM TRIGGER WHEN NOT DRIVING FASTENERS TO AVOID ACCIDENTAL FIRING. CHOICE OF TRIGGERING METHOD IS IMPORTANT. CHECK MANUAL FOR TRIGGERING OPTIONS. NEVER DISABLE LOCK-OFF. USE LOCK-OFF WHEN TOOL IS NOT IN USE. ENSURE TRIGGER AND CONTACT TRIP OPERATE PROPERLY BEFORE USE. NEVER POINT TOOL AT YOURSELF OR OTHERS IN WORK AREA. REMOVE BATTERY WHEN CHECKING PROPER OPERATION OF CONTACT TRIP AND TRIGGER, CLEARING JAMS, OR SERVICING. USE ONLY WITH DEWALT BATTERIES AND CHARGER. À TITRE PREVENTIF, LIRE LE GUIDE.

DEWALT INDUSTRIAL TOOL CO., BALTIMORE, MD 21286 USA FOR SERVICE INFORMATION, CALL 1-800-4-DEWALT www.DEWALT.com SER: _____

ADVERTENCIA PARA DISMINUIR EL RIESGO DE LESIONES, EL USUARIO DEBERÁ LEER EL MANUAL DE INSTRUCCIONES. TODO OPERARIO Y DEMÁS PERSONAS EN EL ÁREA DE TRABAJO DEBERÁ LLEVAR ANTEOJOS DE PROTECCIÓN ANSI Z87.1 CON GUARDAS LATERALES. MANTENGA LOS DEDOS ALEJADOS DEL GATILLO CUANDO NO ESTÉ CLAVANDO A FIN DE NO ACCIONAR LA HERRAMIENTA INADVERTIDAMENTE. EL MÉTODO DE DISPARO ES IMPORTANTE. CONSULTE LAS OPCIONES QUE OFRECE EL MANUAL. NUNCA DESHABILITE EL SEGURO. UTILICE EL SEGURO CUANDO LA HERRAMIENTA NO SE ENCUENTRE EN FUNCIONAMIENTO. ASEGÚRESE QUE EL GATILLO Y EL DISPARADOR POR CONTACTO FUNCIONEN DEBIDAMENTE ANTES DE ACCIONAR LA HERRAMIENTA. JAMÁS ORIENTE LA HERRAMIENTA HACIA SI MISMO NI HACIA LAS DEMÁS PERSONAS EN LA ZONA DE TRABAJO. RETIRE LA BATERÍA DE LA HERRAMIENTA CUANDO PRESTE CUALQUIER TIPO DE MANTENIMIENTO, CUANDO DESTRABE LOS SUJETADORES O CUANDO VERIFIQUE EL FUNCIONAMIENTO APROPIADO DEL DISPARADOR POR CONTACTO O DEL GATILLO. LA HERRAMIENTA SE DEBERÁ UTILIZAR SOLAMENTE CON LAS BATERÍAS Y CON LOS CARGADORES DEWALT.

AVERTISSEMENT AFIN DE MINIMISER LES RISQUES DE BLESSURES, L'UTILISATEUR DOIT LIRE LE GUIDE D'UTILISATION. LES PERSONNES QUI UTILISENT L'OUTIL ET LES PERSONNES QUI SE TROUVENT DANS LA ZONE DE TRAVAIL DOIVENT PORTER DES LUNETTES DE SÉCURITÉ À ÉCRANS LATÉRAUX CONFORMES À LA NORME ANSI Z87.1. ÉLOIGNER LES DOIGTS DE LA DÉTENTE LORSQU'ON N'ENFONCE PAS D'ATTACHES AFIN D'ÉVITER LE FONCTIONNEMENT ACCIDENTEL DE L'OUTIL. LE CHOIX DE LA MÉTHODE D'ACRAFAJE EST IMPORTANT. VÉRIFIER LES OPTIONS DE DÉTENTE DANS LE GUIDE D'UTILISATION. NE NEUTRALISEZ JAMAIS LOCK-OFF. UTILISER LE DISPOSITIF DE VERROUILLAGE EN MODE HORS TENSION LORSQUE L'OUTIL NE SERT PAS. S'ASSURER QUE LA DÉTENTE ET LE DÉCLENCHEUR FONCTIONNENT CONVENABLEMENT AVANT D'UTILISER L'OUTIL. NE JAMAIS POINTER L'OUTIL VERS SOI OU VERS D'AUTRES PERSONNES DANS LA ZONE DE TRAVAIL. ENLEVEZ LA BATTERIE QUAND : VÉRIFICATION DE L'OPÉRATION APPROPRIÉE DU VOYAGE ET LE DÉCLENCHEMENT DE CONTACT, LES BOURRAGES DÉGAGANTS, OU ENTRETIEN. EMPLOYEZ SEULEMENT AVEC LES BATTERIES ET LE CHARGEUR DE DEWALT.

TROUBLESHOOTING GUIDE

MANY COMMON PROBLEMS CAN BE SOLVED EASILY BY UTILIZING THE CHART BELOW. FOR MORE SERIOUS OR PERSISTENT PROBLEMS, CONTACT A DeWALT SERVICE CENTER OR CALL 1-(800)-4-DeWALT.

⚠ WARNING: TO REDUCE THE RISK OF SERIOUS PERSONAL INJURY, ALWAYS DISCONNECT BATTERY PACK FROM TOOL BEFORE ALL REPAIRS

SYMPTOM	CAUSE	FIX
Motor does not run with trigger depressed	Trigger lock in locked position	Unlock trigger lock.
	Tool is stalled, locking the motor from rotating	Rotate the stall release lever on the tool and the mechanism will release. If driver blade does not return, remove battery and manually push driver blade back to home position.
	Tool is in the sequential actuation mode	Depress contact trip first before firing or switch to bump mode.
	Tool internal electronics need to be reset	Remove battery, wait 3 seconds and reinsert.
	Motor stops running after 5 seconds	Normal operation, release trigger and redepress.
	Terminals are dirty or damaged	See authorized service center.
	Damaged internal electronics	See authorized service center.
	Damaged Trigger	See authorized service center.
Motor does not run with contact trip depressed	Trigger lock in locked position	Unlock trigger lock.
	Dryfire lock out engaged, blocking contact trip from traveling fully	Load more nails into magazine.
	Tool is stalled, locking the motor from rotating	Rotate the stall release lever on the tool and the mechanism will release. If driver blade does not return, remove battery and manually push driver blade back to home position.
	Bent contact trip	See authorized service center.
	Motor stops running after 5 seconds	Normal operation, release contact trip and redepress.
	Terminals are dirty or damaged	See authorized service center.
	Damaged internal electronics	See authorized service center.
	Damaged Trigger	See authorized service center.
Tool does not actuate (motor runs but will not fire)	Dryfire lock out engaged, blocking contact trip from traveling fully	Load nails into magazine.
	Low battery charge or damaged battery	Check charge level if pack shows state-of-charge. Charge or replace battery pack if necessary.
	Jammed nail/driver blade not returned to home position	Remove battery, clear jammed nail, cycle stall release lever, (push driver blade up manually if necessary) reinsert battery pack.
	Damaged driver/return assembly	Replace driver/return assembly. See authorized service center.
	Jammed internal mechanism	See authorized service center.
	Damaged internal electronics	See authorized service center.
Motor starts up but generates a lot of noise	Jammed nail and driver blade is stuck in down position	Use stall release lever, clear and jammed nails, and return driver blade manually if necessary.
	Damaged driver/return assembly	Replace driver/return assembly. See authorized service center.
Drive blade continues to get stuck in down position	Jammed nail and driver blade is stuck in down position	Use stall release lever, clear any jammed nails, and return driver blade manually if necessary.
	Damaged driver/return assembly	Replace driver/return assembly. See authorized service center.
	Debris in nosepiece	Clean nose area and watch closely for small pieces of broken nails stuck in the track.

DEWALT Battery and Charger Systems

Chargers/Charge Time (Minutes) – Chargeurs/Durée de charge (Minutes) – Cargadores de baterías/Tiempo de carga (Minutos)

Battery Cat #	Output Voltage	120 Volts																				12 Volts					
		DC011	DC022	DC9000	DC9310	DC9320	DCB095	DCB100	DCB101	DCB102	DCB103	DCB106	DCB107	DW911	DW9106	DW9107	DW9108	DW9116	DW9117	DW9118	DW9216	DW9226	DW0246	DCB119	DW0249	DW9109	DC9319
DC9360	36	X	X	45	X	X	X	X	X	X	X	X	X	X	X	X	X	X	X	X	X	X	X	X	X	X	X
DCB361	36	X	X	45	X	X	X	X	X	X	X	X	X	X	X	X	X	X	X	X	X	X	X	X	X	X	X
DC9280	28	X	X	60	X	X	X	X	X	X	X	X	X	X	X	X	X	X	X	X	X	X	X	X	X	X	X
DW0242	24	X	X	X	X	X	X	X	X	X	X	X	X	X	X	X	X	X	X	X	X	X	60	X	60	X	X
DCB200	20	X	X	X	X	X	X	X	60	60	60	140	140	X	X	X	X	X	X	X	X	X	X	90	X	X	X
DCB201	20	X	X	X	X	X	X	X	30	30	30	70	70	X	X	X	X	X	X	X	X	X	45	X	X	X	X
DCB203	20	X	X	X	X	X	X	X	35	35	35	90	90	X	X	X	X	X	X	X	X	X	60	X	X	X	X
DCB204	20	X	X	X	X	X	X	X	70	70	70	185	185	X	X	X	X	X	X	X	X	X	120	X	X	X	X
DCB207	20	X	X	X	X	X	X	X	30	30	30	60	60	X	X	X	X	X	X	X	X	X	X	X	X	X	X
DC9096	18	60	60	X	60	60	X	X	X	X	60	X	X	60	X	X	60	60	20	X	60	130	X	X	X	60	60
DC9099	18	45	45	X	45	45	X	X	X	X	45	X	X	45	X	X	45	45	15	X	45	95	X	X	X	45	45
DC9180	18	X	X	X	60	60	X	X	X	X	60	X	X	X	X	X	X	X	X	X	X	X	X	X	X	X	60
DC9181	18	X	X	X	30	30	X	X	X	X	30	X	X	X	X	X	X	X	X	X	X	X	X	X	X	X	30
DW9096	18	60	60	X	60	60	X	X	X	X	60	X	X	60	X	X	60	60	20	X	60	130	X	X	X	60	60
DW9098	18	30	30	X	30	30	X	X	X	X	30	X	X	30	X	X	30	30	12	X	30	60	X	X	X	30	30
DW9099	18	45	45	X	45	45	X	X	X	X	45	X	X	45	X	X	45	45	15	X	45	95	X	X	X	45	45
DC9091	14.4	60	60	X	60	60	X	X	X	X	60	X	X	60	90	60	60	60	20	115	60	115	X	X	X	60	60
DC9094	14.4	45	45	X	45	45	X	X	X	X	45	X	X	45	60	45	45	45	15	90	45	90	X	X	X	45	45
DW9091	14.4	45	45	X	45	45	X	X	X	X	45	X	X	45	60	45	45	45	15	90	45	90	X	X	X	45	45
DW9094	14.4	30	30	X	30	30	X	X	X	X	30	X	X	30	45	30	30	30	12	60	30	60	X	X	X	30	30
DCB120	12	X	X	X	X	X	X	40	30	30	30	X	60	X	X	X	X	X	X	X	X	X	45	X	X	X	X
DCB127	12	X	X	X	X	X	X	X	35	35	35	X	90	X	X	X	X	X	X	X	X	X	60	X	X	X	X
DC9071	12	60	60	X	60	60	X	X	X	X	60	X	X	60	90	60	60	60	20	115	60	115	X	X	X	60	60
DW9050	12	X	X	X	X	X	X	X	X	X	X	X	X	40	X	X	X	X	X	X	X	X	X	X	X	X	X
DW9071	12	45	45	X	45	45	X	X	X	X	45	X	X	45	60	45	45	45	15	90	45	90	X	X	X	45	45
DW9072	12	30	30	X	30	30	X	X	X	X	30	X	X	30	45	30	30	30	12	60	30	60	X	X	X	30	30
DW9048	9.6	X	X	X	X	X	X	X	X	X	X	X	X	40	X	X	X	X	X	X	X	X	X	X	X	X	X
DW9061	9.6	45	45	X	45	45	X	X	X	X	45	X	X	45	60	45	45	45	15	90	45	90	X	X	X	45	45
DW9062	9.6	30	30	X	30	30	X	X	X	X	30	X	X	30	45	30	30	30	12	60	30	60	X	X	X	30	30
DCB080	8	X	X	X	X	X	60	X	X	X	X	X	X	X	X	X	X	X	X	X	X	X	X	X	X	X	X
DW9057	7.2	30	30	X	30	30	X	X	X	X	30	X	X	30	45	30	30	30	12	60	30	60	X	X	X	30	30

"X" Indicates that the battery pack is not compatible with that specific charger.

"X" indique que le bloc-piles n'est pas compatible avec ce chargeur.

Una "X" indica que el paquete de baterías no es compatible con ese determinado cargador.

All charge times are approximate. Actual charge time may vary. Read the instruction manual for more specific information.

Les durées de charge sont approximatives; la durée de charge réelle peut varier. Lire le manuel d'utilisation pour obtenir des renseignements plus précis.

El tiempo de duración de carga es aproximado; la duración de carga real puede variar. Lea el manual de instrucciones para obtener información más precisa.

DEWALT Industrial Tool Co., 701 East Joppa Road, Baltimore, MD 21286

(NOV13)

Part No. N329480

DCN690, DCN692

Copyright © 2012, 2013 DEWALT

The following are trademarks for one or more DEWALT power tools: the yellow and black color scheme; the "D" shaped air intake grill; the array of pyramids on the handgrip; the kit box configuration; and the array of lozenge-shaped humps on the surface of the tool.