

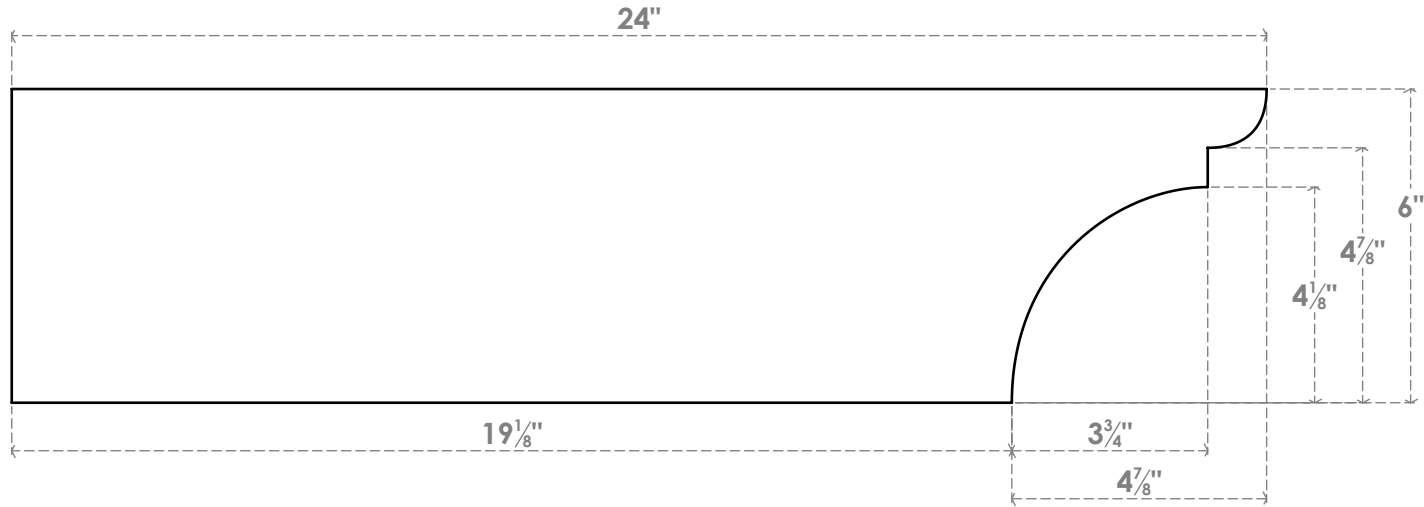

RFTP04X06X24YOR

4"W X 6"H X 24"L YORKTOWN ARCHITECTURAL GRADE PVC RAFTER TAIL



SIDE PROFILE

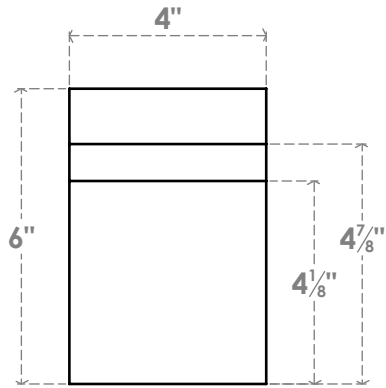

FRONT PROFILE

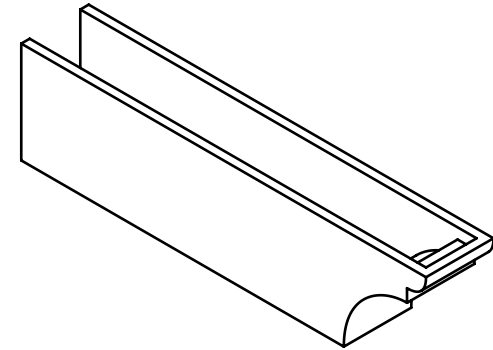

ISOMETRIC

DATE



EKENA MILLWORK
 2300 WEST MAIN ST.
 CLARKSVILLE, TX 75426
 TOLL FREE: 866-607-0453
 WWW.EKENAMILLWORK.COM

NOTES

1. INSTALLATION TO BE COMPLETED IN ACCORDANCE WITH MANUFACTURER'S SPECIFICATIONS.
2. DRAWING MAY NOT BE TO SCALE
3. THIS DRAWING IS INTENDED FOR DESIGN AND PLANNING PURPOSES ONLY.
4. ALL INFORMATION CONTAINED HEREIN WAS CURRENT AT THE TIME OF DEVELOPMENT BUT MUST BE REVIEWED AND APPROVED BY THE PRODUCT MANUFACTURER TO BE CONSIDERED ACCURATE.
5. ARCHITECTURAL GRADE PVC PRODUCTS ARE MADE FROM EXPANDED CELLULAR PVC AND COME NATURALLY WHITE BUT MAY BE PAINTED