

Reverse Osmosis Water Filtration System

Installation and Operation Manual



WARNING

Please read this manual carefully before using your product, and keep it for future reference. As the appliance is kept upgrading, it may differ between the actual appliance and the one in the manual. Please refer to the actual product.



WARNING

- Please use municipal tap water as the water source. Do not use water that is microbiologically unsafe or of unknown quality without adequate disinfection before or after the system.
- Be sure to handle the system gently and carefully. Do not attempt to modify or repair the system yourself, otherwise, the warranty will become invalid.
- This device is intended for domestic use only.
- The inlet water temperature of the system should be within 40~100 °F (5~38 °C). When the inlet water temperature exceeds 100 °F (38 °C), the filter could be damaged and become invalid. If the inlet water temperature is lower than 41 °F (5°C), it may cause freezing and the parts of the system to rupture, resulting in water leakage.
- Do not reverse the installation order of the filter cartridges to avoid affecting the filter performance of the system.
- If the system is abnormal or faulty, stop using it immediately. Close the inlet water valve and turn on the faucet to empty the system. Events of faults include:
 - Leakage
 - The product is cracked or damaged
 - There is an abnormal sound or burnt smell
 - The machine does not work
 - Please contact consumer care for inspection immediately.
- If not using the system for an extended period, turn off the water supply to avoid damage to the system.

CONTENTS

1 Explanation of Symbols and Safety Instructions	05
1.1 Recognize Safety Information	05
1.2 Understand Signal Words	05
1.3 Installation Tips	05
2 General Information	06
2.1 Product Specification	06
2.2 Product Overview and Installation Illustration	07
3 Installation	08
3.1 Installation Instructions	08
3.2 Selecting The Faucet Location	09
3.3 Install The Angle Stop Valve for the Feed Water	10
3.4 Install The Faucet	11
3.5 Install RO Drain Connector	11
3.6 Connecting The System	12
4 Operation	13
4.1 Before the First-time Use	13
4.2 User Interface	13
5 Maintenance	15
5.1 Filter Cartridge Replacement	15
5.2 Automatic Flushing	16
6 Troubleshooting	17

1 Explanation of Symbols and Safety Instructions

This manual has safety information and instructions to help you eliminate or reduce the risk of accidents and injuries.

1.1 Recognize Safety Information

 This is the safety alert symbol. It is used to alert you to potential physical injury hazards. Obey all safety messages that follow this symbol to avoid possible injury or death.

1.2 Understand Signal Words

A signal word will identify safety messages and property damage messages, and also will indicate the degree or level of hazard seriousness.



DANGER

Indicates an imminently hazardous situation which, if not avoided, will result in death or serious injury.



WARNING

Indicates a hazardous situation that, if not avoided, could result in death or serious injury.



CAUTION

Indicates a hazardous situation which, if not avoided, could result in property damage and minor or moderate injury.



NOTICE

This symbol indicates important information where there is no risk to people or property.

1.3 Installation Tips

Please read this manual and the labels on the Water filter before you install, operate, or service it. Then inspect the package. Open the box and take out the reverse osmosis system, all the components and connector fittings. Check the packing list to confirm all accessories are included in the package. Contact Mizudo customer service if any components are missing or damaged during shipping. If there are any parts cracked or broken, please do not proceed with the installation and contact us. Identify and get familiar with all components for quick installation.



NOTICE

Before installing this reverse osmosis system, make certain your water supply complies with the following operating specifications. Failure to do so may reduce the effectiveness of the system and will void the warranty.

2 General Information

2.1 Product Specification

Model	WD600	WP600
Part No.	WD600A0W	WP600A0W
Daily Production Capacity	400 GPD	600 GPD
Operating Water Temperatures	40-100 °F (5-38 °C)	
Operating Water Pressure	15-100 psi (0.1-0.7 MPa)	
Power Specifications	Input:100-240V AC Output:24V DC	
Feed Water Requirement	Municipal Tap Water	
pH Parameters	2-11	
TDS (Total Dissolved Solids)	< 1800 ppm	
Iron	< 0.2 ppm	
Turbidity	< 5 NTU	
Hardness	< 10 gpg (170 mg/L)	

Hardness: Recommended hardness not to exceed 10 grains per gallon, or 170 parts per million.

Note: System will operate with hardness over 10 grains but the membrane life may be shortened. The addition of a water softener may lengthen the membrane life.

Water Pressure: The operating water pressure in your home should be tested over a 24 hour period to attain the maximum pressure. If the incoming water pressure is above 80 psi then a water pressure regulator is required.

2.2 Product Overview and Installation Illustration

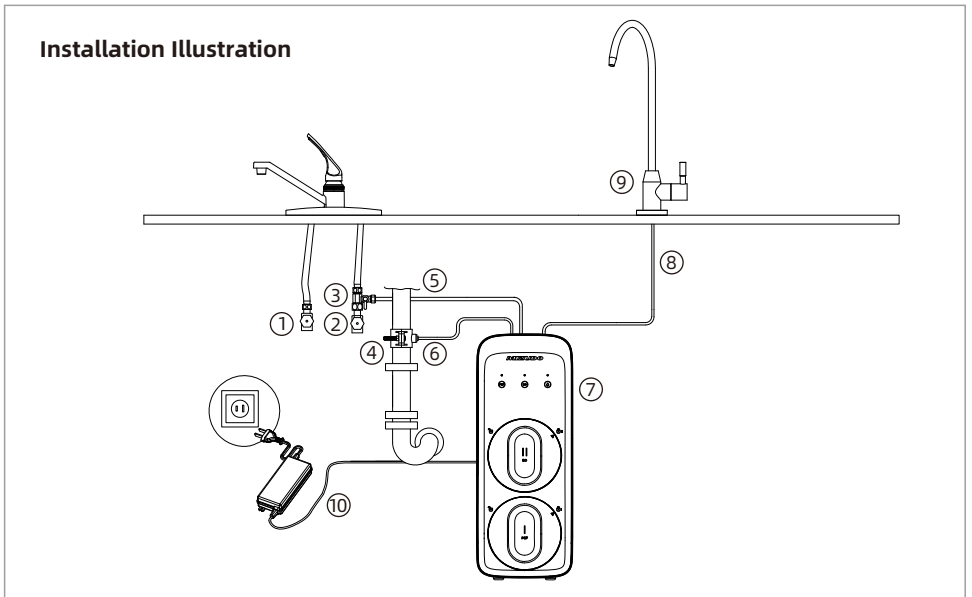
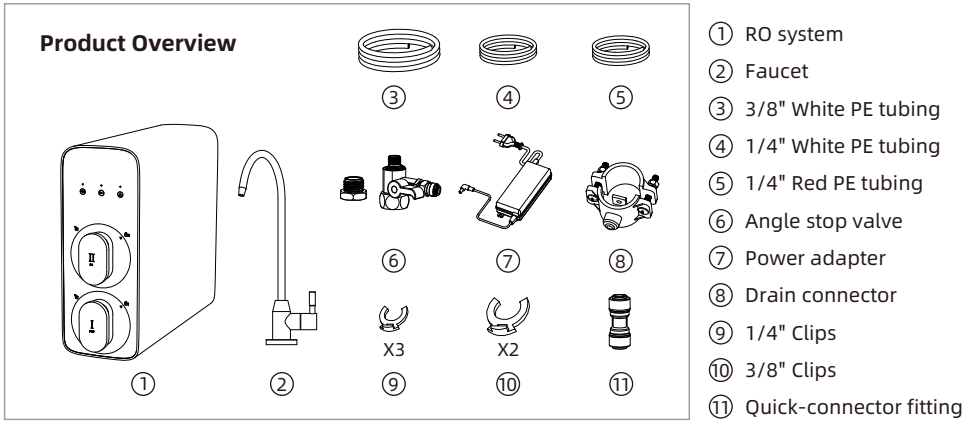

- ① Hot water valve
- ② Cold water valve
- ③ Angle stop valve
- ④ Drain connector
- ⑤ Water inlet tubing
- ⑥ Drain outlet tubing
- ⑦ Reverse osmosis system
- ⑧ Filtered water outlet tubing
- ⑨ Faucet
- ⑩ Power adapt

Tools and Materials Required

- Hand or electric drill(cordless preferred)
- Adjustable wrenches
- Slotted and Phillips screwdrivers
- Utility knife or scissors
- Safety glasses
- Drill bits: 1"(for faucet hole), 1/4"(for drain tubing)
- Safety mask



NOTICE

Not all tools may be necessary for installation. Read installation procedures before starting to determine what tools are required.

3 Installation

3.1 Installation Instructions

Read all installation and operating instructions before installing and using your RO system.



NOTICE

- Please check if there is sufficient space for installing the system itself, its accessories, connection.
- Under no circumstances should the system be installed outdoors.
- The environment where the system is installed should adhere to appropriate hygiene and sanitation conditions. Avoid any external dripping liquids from pipes or drains, etc, onto the system.
- This system should be placed on a stable and at the surface.
- Keep the system away from heat. It shall not be placed in a place that may have in-inflammable gas leakage.

How to use the quick-connector fitting

To connect

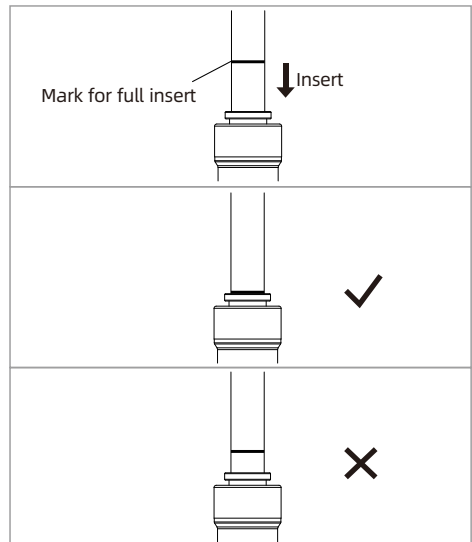

- There is an existing mark at the PE end of the PE tubing for you to confirm if the PE tubing is fully inserted into the fitting.
- Push the PE tubing into the fitting until you reach the mark on the tubing.

**NOTICE**

If the PE tubing is not fully inserted, no seal will be created, and leakage will occur.

- When the PE tubing is fully inserted, put the clip on the fitting. It will lock the PE tubing in place and prevent it from falling off.

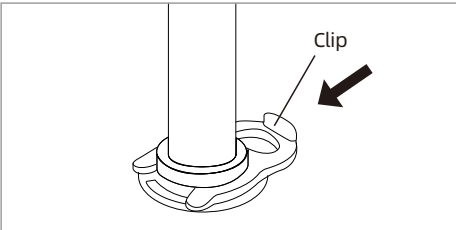
**NOTICE**

If the PE tubing is too long, cut it to a suitable length with a sharp utility knife or scissors. Cut the PE tubing squarely and cleanly. Make sure the PE tubing is fully inserted.

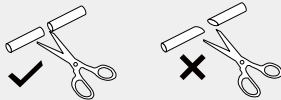
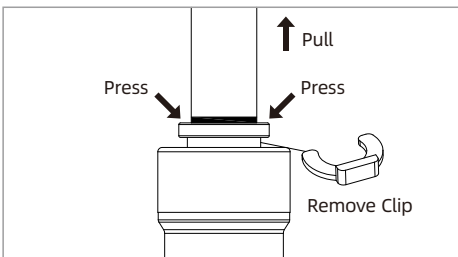
**To disconnect**

- Remove the blue lock clip from the fitting;
- Use your thumb and index finger to press down the lock sleeve. Use your other hand to pull out the PE tubing from the fitting.

**NOTICE**

Please do not pull out the PE tubing directly. This will damage the fitting and cause leakage.

3.2 Selecting The Faucet Location

Most sinks have pre-drilled holes designed for spray hoses. The RO faucet may be through using one of these holes despite their larger size. If these pre-drilled holes cannot be used or are in an inconvenient location, it will be necessary to drill a 1/2" hole in the sink or through the countertop next to the sink.

**CAUTION**

- This procedure may generate dust, which can cause severe irritation if inhaled or come in contact with the eyes. Safety glasses and a safety mask are recommended for this procedure.
- Do not attempt to drill through an all-porcelain or porcelain-coated sink. For applications on these types of sinks, we recommend using the sprayer hole or drilling the hole through the countertop.
- When drilling through a countertop, make sure the area below the drilled area is free of wiring and piping. Make certain that you have ample room to make the proper connections to the bottom of the countertop.
- Do not drill through a countertop that is more than 1 inch thick.
- Do not attempt to drill through a tiled, marble, granite or similar countertop. Consult a plumber or the countertop manufacturer for advice or assistance.

The following instructions apply to stainless steel sinks ONLY.

- Line the bottom of the sink with newspaper to prevent shavings, parts or tools from falling down the drain.
 - Place masking tape over the area to be drilled to help prevent scratches if drill bit slips.
- © Mark the point with a center punch. Use a 1/4-inch drill bit to drill a pilot hole through the sink.
- Use a 1/2" hole saw to enlarge the hole. Smooth rough edges with a file.

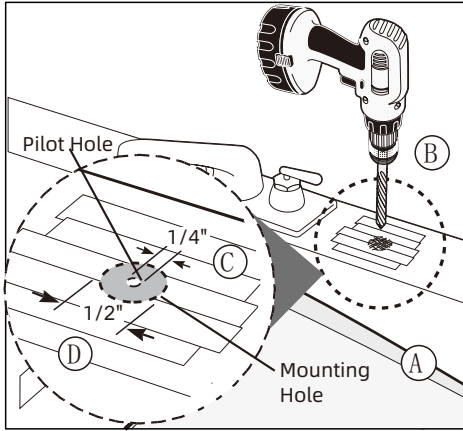

3.3 Install The Angle Stop Valve for The Feed Water

(Fits 1/2" - 14 NPS supply threads or 3/8" compression).

(A) Turn off the cold water supply valve. Turn on the kitchen cold water faucet to release the pressure and allow water to drain from the line. Disconnect the cold water hose from the cold water valve.

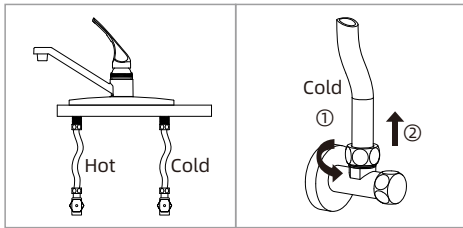

(B) Insert the 3/8" white PE tubing into the angle stop adapter's fitting. Secure the tubing with a 3/8" clip.

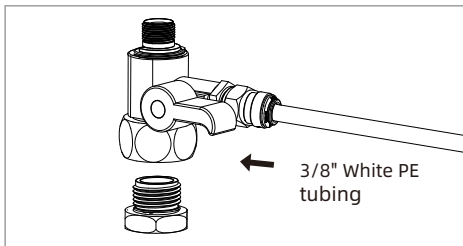

(C) Install the Angle Stop Valve on the cold water valve and tighten it with an adjustable wrench. Please don't miss the gasket inside the angle stop adapter during installation.



NOTICE

If the cold water tubing is 1/2", screw the conversion adaptor upper the Angle Stop Valve.

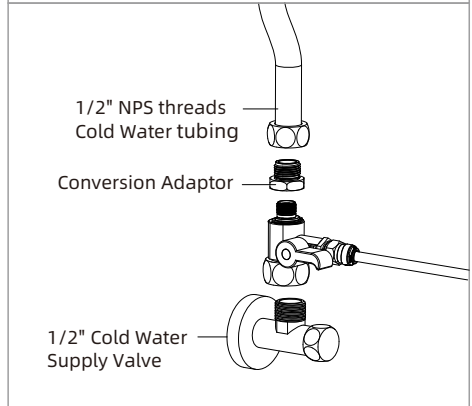
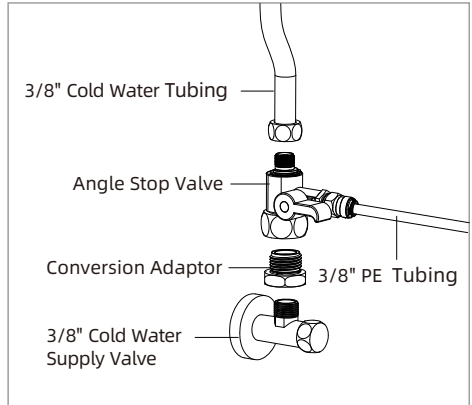

(D) Switch off the angle stop adapter. Turn on the cold water supply valve. Wipe the connections with a tissue to check for leakage. If the tissue stays dry, the angle stop valve is installed correctly.

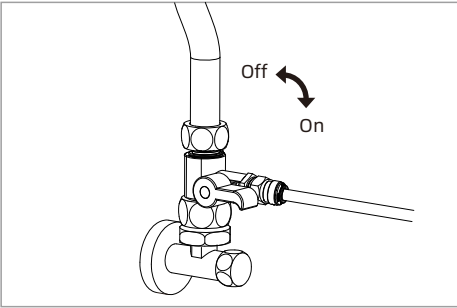

3.4 Install The Faucet



NOTICE

If your kitchen sink or countertop does not have an existing hole, you will have to drill one. Refer to chapter 3.2.

1. Insert the faucet into the hole on the countertop. (As shown in the image below)
2. Under the sink, slip on the nut and tighten it up (Do not forget the washer).
3. Insert the quick-connect fitting onto the faucet stem fully and firmly

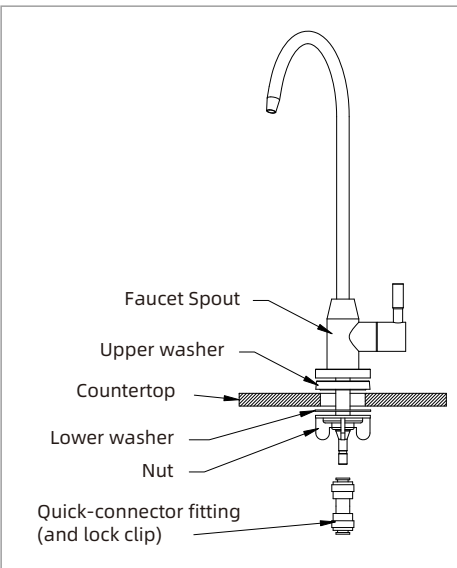

3.5 Install RO Drain Connector

1. Identify drain outlet location.
2. Knock out the center hole on the foam seal (④).
3. Use the hole in the foam seal (④) as a template to locate your drilling position above the drain tap. Mark the location with a pencil. Note: If you have a double sink and cross- or horizontal drain tubing, it is safe to mark the drill location on the top of the horizontal drain tubing.
4. At the marked location, drill a 1/4" hole through the wall of the drain tubing, being sure not to penetrate the opposite side of the tubing.
5. Remove the protective cover from the back of the foam seal (④) and attach it to the front plate of the drain connector (①) in alignment with the holes.
6. Begin to position the drain connector (①) on the sink drain tubing with Screws (②) and Nuts (③), using your pencil (or a thin pen) in the drain connector (①) tube hole to guide your location over your drilled hole as you securely tighten Nuts (③) and Screws (②).



NOTICE

Remove the pencil once the location is established.

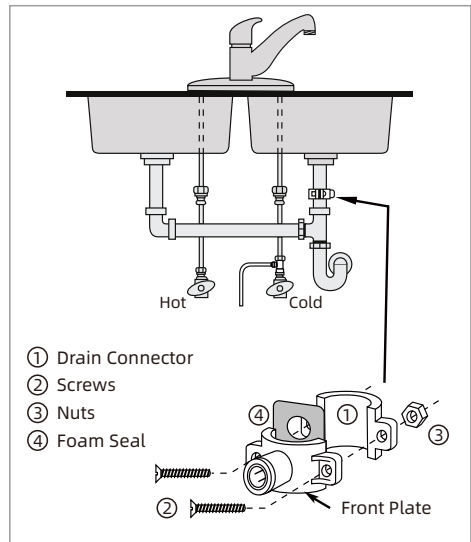

3.6 Connecting The System

1. Before connecting the PE tubing to the system, ensure you have removed the plug from the water port.
2. Connecting the tubing to the System
 - a. Connect the 3/8" White Tubing from the Angle stop valve to the "Raw Water" port.
 - b. Connect the 1/4" Blue Tubing from the Faucet to the "Pure Water" port.
 - c. Insert 1/4" Red Tubing from the Drain connector to the "Drain Water" port.



NOTICE

DO NOT insert the plug into the socket yet.

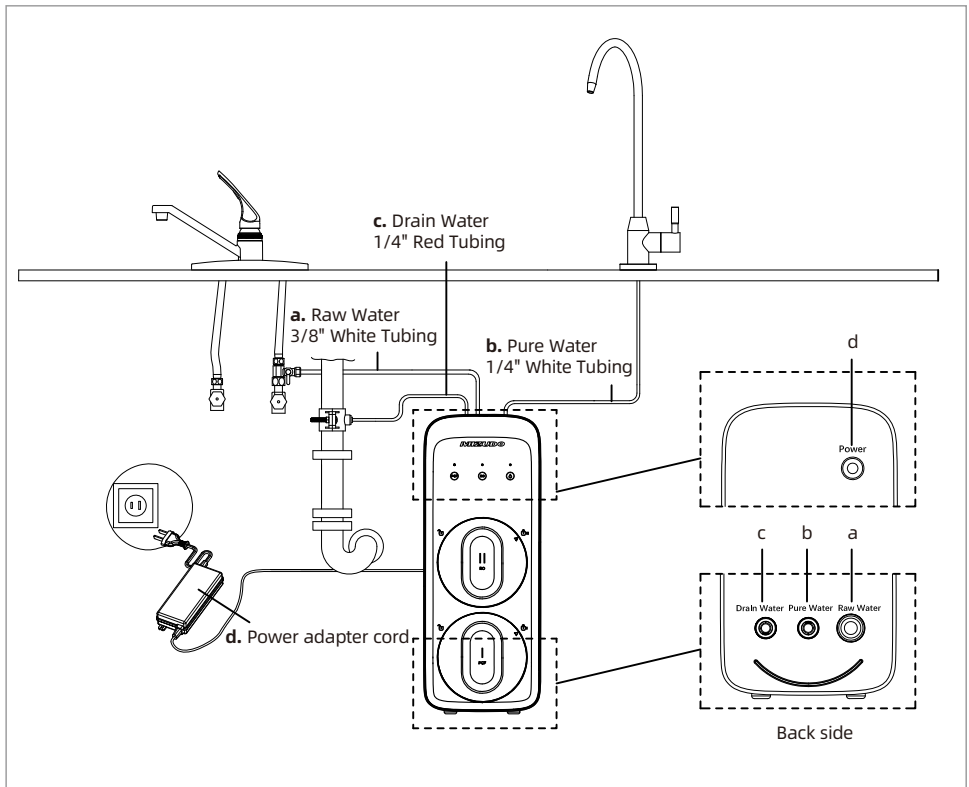

4 Operation

4.1 Before The First-time Use

- (A) Turn on the cold water supply and ensure the supply adapter valve is open.
- (B) Connect the system with power. You will hear a long beep, and all indicators will light up for 3s. The system will automatically flush for 30s.
- Wipe all the joints and connections with tissue to check for leakage. If the tissue stays dry, the system is installed correctly.
- (C) After the auto-flush is completed, turn on the faucet to allow water to run for 30 minutes to flush the air and carbon fines through the filters. After that, the system is ready, and you can start to consume the pure water.



NOTICE

Initially, the water may appear cloudy. This is a result of air trapped in the RO filter. It is not harmful and will disappear in a matter of minutes. It may take up to a week after installing a new RO filter for the trapped air to dissipate.

4.2 User Interface

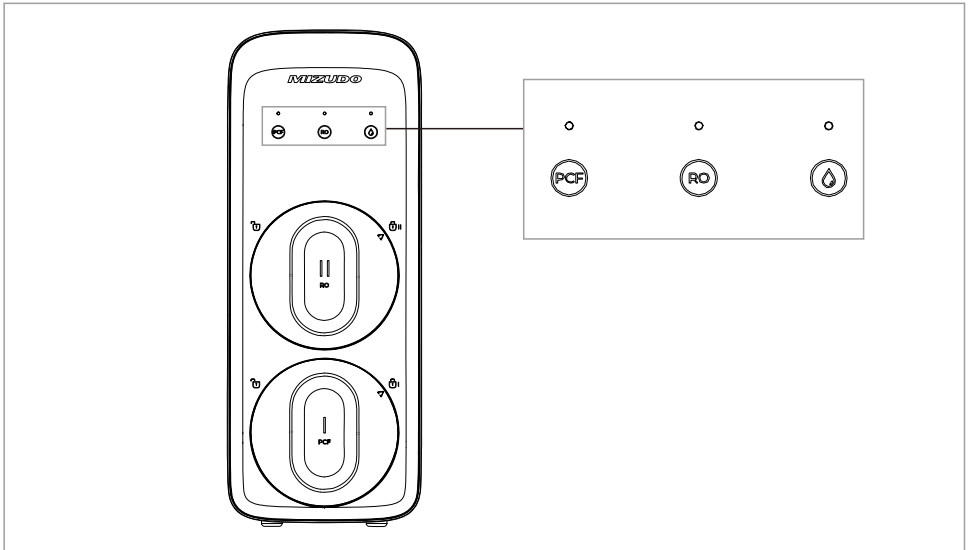

Indicator	Indication	Status
PCF lifetime indicator & Reset button	Constant blue light	Lifetime > 95%
	Flash red light	$0 < \text{Lifetime} \leq 5\%$
	Constant red light	Lifetime = 0
RO lifetime indicator & Reset button	Constant blue light	Lifetime > 5%
	Flash red light	$0 < \text{Lifetime} \leq 5\%$
	Constant red light	Lifetime = 0
Power indicator	Constant blue light	Power on
	Flash red light	System Malfunction

Reset button

To reset the filter lifetime, long press the reset button for 3s. You will hear a beep, and the indicator will flash a constant blue light. The filter lifetime has been reset.

5 Maintenance

If you plan on not using the system for one week or longer, take out the filter and seal it with plastic wrap. Store the sealed filter in the fridge to protect the system against microbiological growth. To start the system again after the period of non-use, flush the system for at least 10 minutes OR change the filters.

If you will not use the system for two weeks or longer, disconnect the water supply, drain the system, and disconnect the power.

Follow the recommended filter replacement schedule. Replace the filter any time the indicator is on. Note that the actual filter life depends on the family size and water source quality. Failure to replace the filter at the appropriate times can damage the system and potentially cause health hazards.

5.1 Filter Cartridge Replacement



NOTICE

The life of the filter cartridges depends on the water volume used and the quality of the feed water. For the best performance, please change your filter cartridge according to the filter lifetime indicator or the filter replacement cycle suggested below. When there is a noticeable change in taste, odor, or flow of filtered water, we recommend changing the filters as well.

Filter Service Life Table

Filter	Recommended replacement cycle
PCF Filter	12 months/1,000 gallons
RO Filter	24 months/2,000 gallons

The actual lifetime of the filter cartridge depends on the local tap water quality and daily usage.

The recommended replacement cycle is an average based on different local tap water quality. If the local tap water quality is below the

average, the actual lifetime of the cartridge would differ from the recommended replacement cycle. If the filter cartridge is blocked, please replace it.

Filter cartridge replacement

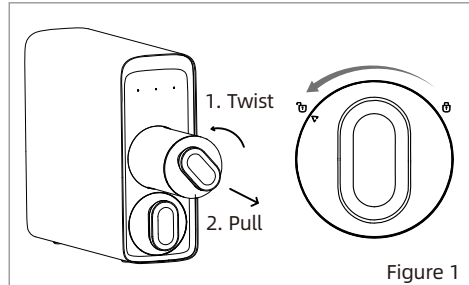

Figure 1

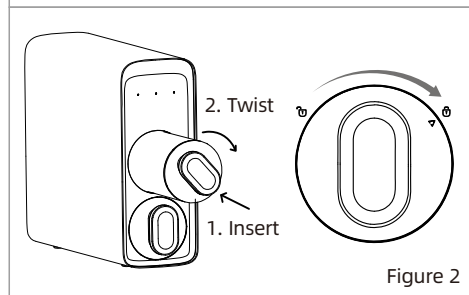

Figure 2

- Turn off the power and water supply before replacing the filter cartridges.
- Twist the filter that needs to be replaced anticlockwise and pull it out (Figure 1).
- Remove the packaging of the new filter and insert the cartridge in the system. Twist it clockwise to align the triangle icon on the filter cartridge with the lock icon on the system (Figure 2).
- Turn on the water supply and re-connect with power. If the RO filter is replaced, turn on the faucet and allow the water to run for 30 minutes. If the PCF filter is replaced, turn on the faucet and allow the water to run for 10 minutes
- Reset the filter lifetime, press and hold the reset button for 3 seconds. You will hear a beep, and the indicator will flash a constant blue light. The filter lifetime has been reset.

5.2 Automatic Flushing

While the system is flushing, the faucet indicator will flash blue light. The system will be flushed automatically in one of the following situations:

1. Flush for Power Restore

When power is restored after a blackout, the system will be forced to be flushed automatically for 30 seconds.

2. Flush for Accumulative Time per 24 hours

To maintain and extend the life expectancy of the filters, the system will be automatically flushed for 30 seconds per 24 hours.

The flush mode doesn't affect the user when taking water. If the user decides to take water during the flushing, the system will quit flushing and switch to dispensing.

6 Troubleshooting

Problem	Possible cause	Solution
No water comes out from the faucet.	Cold water valve or the angle stop valve is turned off.	Turn on the valves.
	The system is not connected with power.	Check if the power adapter is connected to the system and the power socket properly.
The flow rate gets slower.	Filter is blocked.	Replace the filter.
	The tubing is bent.	Make sure the tubing is straightened.
	Inlet water pressure is low.	Wait until the inlet water pressure gets stable, or install a pressure boost before the system if the inlet water pressure is constantly lower than 15 psi.
Poor outlet water quality.	Filter has reached the end of life.	Replace the filter.
	The system hasn't been used for some time.	Turn on the faucet and allow the water to run for 5 minutes.
	The inlet water quality is poor.	Always use municipal tap water as the water source. Do not use water that is microbiologically unsafe or of unknown quality without adequate disinfection before or after the system.
System indicators all flash, the buzzer keep beeps.	The system has been filtering water continuously for 2 hours.	Unplug the system, wait for 1 minute, and plug in again to shoot the trouble.
	The PCB board is damaged.	Contact customer services.
No water runs to the drain.	The drain tubing is bent.	Make sure the tubing is straightened, or replace with a new tubing.
	System malfunctions.	Contact consumer services.
There is leakage.	The tubing are not connected properly.	Reconnect the tubing.
	System malfunctions.	Contact customer services.

Problem	Possible cause	Solution
High TDS of the filtered water.	The system hasn't been used for a long time.	Open the RO faucet, allow it to run for a while. The TDS valve will return to normal.
	The RO filter expired.	Replace the RO filter immediately.
	The drain pipe is bent.	Make sure the tubing is straightened, or replace with a new tubing.
	The source water may have a high TDS.	Test the source water and filtered water. The filtered water's TDS shall be about 0%-10% of your source water's TDS. This is a normal range. If there is a high TDS in the source water, it may reduce the service life of the system.
Loud sound	The system is not positioned in a flat area.	Reconnect the tubing.
	The system is placed against the cabinet.	Not place the system against the cabinet. The system may vibrate when it works.
	The water pressure is unstable.	Check and confirm the water pressure is between 14.5 PSI and 100 PSI. The sound will decrease when the water pressure becomes stable.

MIZUDO
Comfort with Innovation

Tel: 877-216-1818 | E-mail: us.mizudo@fogatti.com